



PRONAUTIC
Marine Equipment

RECAMBIOS para MOTORES **FUERABORDA** **INTRABORDA** **2018**

MOTORES HIDEA
FUERABORDA
INTRABORDA
HÉLICES
ACEITE
LUBRICANTES



CONDICIONES DE LA GARANTIA SIERRA PARA CLIENTES PROFESIONALES

Todos los productos Sierra están garantizados en caso de piezas defectuosas, dicha garantía se regirá por las siguientes condiciones.

Todos los componentes Sierra que originalmente hayan sido instalados por un mecánico profesional y esten defectuosas, la pieza será abonada así como los gastos asociados que haya podido generar el cambio de dicha pieza.

La mano de obra se calculará basándose en los tiempos de recambio establecidos y fijados para cada componente.

Para tramitar la garantía el primer paso es devolver el recambio defectuoso indicando la referencia, la fecha de compra y el fallo detectado. Una vez sea recibido por Pronautic nosotros lo enviaremos a Sierra.

En el caso que hayan gastos asociados, mano de obra etc.. se deberán detallar en el momento de la devolución del material físicamente. Es imprescindible reclamar todo los gastos en el momento de la devolución física del material.

En dicho escrito deberá detallarse:

- 1- Todos los componentes utilizados para la reparación en garantía.
- 2- Las horas de mano de obra detalladas. Detallar las horas manos de obra en los recambios reemplazados.
- 3- Año, modelo y número de serie del motor.
- 4- Nombre y dirección del distribuidor donde se adquirió la pieza.
- 5- Nombre y dirección del cliente final.
- 6- Cualquier otra información adicional.

Excepciones de la garantía.

En los siguientes casos la garantía quedaría invalidada:

- a- Instalación y uso incorrecto. Cuando se instalen productos en una aplicación no detallada en nuestro catálogo.
- b- Artículos modificados.
- c- Incorrecto mantenimiento.

Para más información contacte con el departamento de recambios.

recambios@pronautic.net

ÍNDICE ALFABÉTICO

GUÍA RÁPIDA POR MARCAS DE MOTOR/COMPETENCIAS COMPONENTES VARIOS MARCAS DE MOTORES FUERABORDA/INTRABORDA

HONDA - Pág.15 a 27

Cruce de referencias Honda original/Pronautic.....	721
Hélices Honda	707-708
Cruce de referencias hélices Honda original/Pronautic.....	707-708
Bujías.....	26-27

JOHNSON/EVINRUDE - Pág. 28 a 129

Cruce de referencias original Johnson/Evinrude/Pronautic.....	721,736 a 742
Hélices BRP-Johnson/Evinrude	708 a 710
Cruce de referencias hélices BRP-Johnson/Evinrude original/Pronautic.....	708 a 710
Bujías.....	127 a 129

MERCURY/MARINER - Pág. 131 a 237

Cruce de referencias original Mercury/Mariner/Pronautic	721 a 736
Hélices Mercury/Mariner.....	703-704
Cruce de referencias hélices Mercury original/Pronautic	703-704
Bujías.....	230 a 237

MERCUISER Pág. 376 a 545

Cruce de referencias original Mercruiser/Pronautic	721 a 736
Hélices Mercruiser	703-704
Cruce de referencias hélices Mercruiser original/Pronautic	703-704
Bujías.....	544 a 545

OMC Pág. 546 a 621

Cruce de referencias original OMC/Pronautic.....	736 a 742
Hélices OMC	701,708 a 710
Cruce de referencias hélices OMC original/Pronautic.....	701,708 a 710
Bujías.....	620

SUZUKI - Pág.247 a 264

Cruce de referencias original Suzuki/Pronautic.....	742
Hélices Suzuki	705-706
Cruce de referencias hélices Suzuki original/Pronautic	705-706
Bujías.....	261 a 264

TOHATSU - Pág.238 a 246

Cruce de referencias original Tohatsu/Pronautic.....	736
Hélices Tohatsu	706-707
Cruce de referencias hélices Tohatsu original/Pronautic.....	706-707
Bujías.....	245-246

VOLVO - Pág. 361 a 375 y 622 a 683

Cruce de referencias original Volvo/Pronautic.....	742 a 745
Hélices Volvo	710
Cruce de referencias hélices Volvo original/Pronautic	710
Bujías	681 a 683
Turbos	372,683

YAMAHA - Pág. 265 a 338

Cruce de referencias original Yamaha/Pronautic	745 a 748
Hélices Yamaha.....	701 a 703
Cruce de referencias hélices Yamaha Original/Pronautic	701 a 703
Bujías.....	335 a 338

YANMAR - Pág. 361 a 375

Cruce de referencias original Yanmar/Pronautic	748
Turbos	372

COMPETENCIAS

GLM Cruce de referencias GLM/Pronautic 714 a 720

VARIOS

Aceites y Lubricantes 684 a 687
 Bloques de motor remanufacturados 339 a 342
 Mangueras..... 687
 Motores Fueraborda HIDEA 11 a 13

Bloques de motor - Pág. 339 a 342

Equipos de diagnosis - Pág. 712-713

Componentes Internos de motor - Pág. 344 a 360

MERCUISER - Pág. 376 a 545

Combustible Mercruiser - Pág. 409 a 429

Anti-deflagrante 422
 Bomba combustible eléctrica..... 422 a 426
 Bombas mecánicas de combustible 422 a 426
 Carburadores kits y otros 417 a 421
 Carburadores 413 a 416
 Filtros de combustible..... 429
 Inyección combustible/componentes..... 409 a 411
 Manguito combustible.....417
 Separadores agua/combustible y soporte 426 a 429

Componentes internos Mercruiser - Pág. 477 a 485

Bujías..... 544-545
 Carters..... 477
 Cojinetes..... 481 a 484
 Culatas 477
 Filtros de aceite 477
 Juntas de culata 491
 Juntas/kits..... 486 a 496
 Levas hidráulicas..... 478
 Pistones/aros 478 a 481
 Retenes tapa distribución 485
 Retenes válvula 485

Electricidad Mercruiser - Pág. 399 a 408

Alternadores 405 a 408
 Motores de arranque 399 a 401
 Reguladores de voltaje..... 406
 Solenoides..... 402-403
 Trim/Tilt motores/bombas 403-404

Encendido Mercruiser - Pág. 378 a 398

Bobinas..... 381-382
 Bujías..... 544-545
 Bujías Cables/Kits 395 a 398
 Condensadores 379-380
 Contactos/kits 379
 Conversión kits 383
 Distribuidor tapa 380-381
 Distribuidores..... 384 a 394
 Encendido kits 378-379
 Encendido modulos..... 382
 Rotores..... 380

Refrigeración Mercruiser - Pág. 430 a 476

Alojamiento termostato..... 437
 Bombas circulación de agua 430
 Bombas de agua kits 432-433
 Colectores y accesorios 452 a 476
 Correas..... 447 a 451
 Despieces..... 452 a 465
 Impulsores/kits..... 430 a 433
 Manguitos 443 a 447
 Poleas..... 430
 Termostatos/kits..... 436 a 442

Tabla identificación modelo Mercruiser - Pág. 376-377

Transmisión Mercruiser - Pág. 497 a 539

Ánodos	536-537
Aros	541 a 543
Cable de cambio/kits	520-521
Cardan	514-515
Cilindros/kits-Power trim	533 a 536
Cojinetes/kits	525 a 529
Colas parte inferior	511-512
Colas unidad superior	510-511
Crucetas cardan	414-415
Despieces	500 a 509
Eje transmisión	524 a 526
Ejes hélice	524-525
Engranajes/kits	512 a 514
Fuelles	515,519
Gruesos/kits	510
Hélices	703-704
Manguitos Power trim	531 a 533
Pasador de pivote	533 a 535
Retenes de aceite	540
Retenes/kit	537 a 539
Tapas escape	539
Transom retenes/kits	518
Tuercas hélices/kits	530-531

OMC - Pág. 546 a 621

Combustible OMC - Pág. 562 a 571

Anti-deflagrante	567
Bombas de combustible	567-568
Carburadores	563-564
Kits de carburador y otros	564 a 567
Componentes inyección de combustible	562
Filtros de combustible	570-571
Manguitos de combustible	567
Separadores/soportes de agua/combustible	568 a 570

Componentes internos OMC - Pág. 586 a 588

Cojinetes	588
Culatas	586
Filtros de aceite	586
Juntas de culata	591
Juntas/juegos	589 a 595
Levas hidráulicas	587
Pistones/aros	587
Retenes	588

Electricidad OMC - Pág. 557-562

Alternadores/Kits de reconstrucción	561
Motores de arranque	557-558
Motores trim/tilt	561-562
Reles	561
Solenoides	559-560

Encendido OMC - Pág. 546 a 621

Bobinas	549
Bujías	620
Cables y kits para bujías	556
Condensadores	547
Distribuidores	551 a 555
Kits de conversión	550-551
Módulos de encendido	549
Rotores	547-548
Tapas de distribuidor	548

Refrigeración OMC - Pág. 571 a 585

Alojamientos bombas de agua/kits	574-575
Bombas circulación de agua	571-572
Colectores y accesorios	578 a 585
Correas	577
Despieces	578 a 580

Impulsores/kits.....	572 a 575
Manguitos.....	576-577
Sensores/transmisores de temperatura/presión.....	575
Termostatos/kits.....	575-576

Transmisión OMC - Pág. 596 a 619

Alojamientos cojinetes.....	608
Ánodos.....	610-611
Arandelas.....	598
Aros tóricos.....	617 a 619
Bloqueadores pistones cola.....	609
Cardan.....	598 a 602
Cojinetes.....	604-605
Colas.....	596 a 598
Despieces.....	596-597
Ejes hélice.....	606-607
Ejes transmisión.....	605-606
Engranajes/kits.....	603 a 606
Fuelles/kits.....	602-603
Hélices.....	708 a 710
Piñones embrague.....	606
Retenes de aceite.....	615-616
Retenes transom.....	603
Retenes/Kits.....	610 a 615
Tuercas hélices/kits.....	609

VOLVO PENTA - Pág. 622 a 683

Encendido Volvo - Pág. 625 a 637

Bobinas.....	627
Bujías.....	681 a 683
Cables/kits para bujías.....	630,631
Condensadores.....	625
Distribuidores.....	628-629
Juegos de platinos.....	625
kits de conversión.....	629
Kits de encendido.....	625,632 a 636
Rotores.....	625-626
Tapa distribuidor.....	626-627

Combustible Volvo - Pág. 642 a 650

Bombas de combustible.....	645
Carburadores/kits.....	642 a 644
Filtros de combustible.....	648-649
Manguito/latiguillo de combustible.....	644
Separadores agua/combustible y soportes.....	646 a 648

Componentes internos Volvo - Pág. 663 a 674

Árbol de levas.....	663
Aros.....	666
Cigüeñales/kits.....	667
Cojinetes.....	667
Correas.....	663
Culatas.....	665
Filtros de aceite.....	664
Filtros de aire.....	664
Juntas de culata.....	668 a 670
Juntas/juegos.....	668 a 673
Levas hidráulicas.....	666
Pistones/aros.....	666
Retenes.....	667
Turbos.....	683
Válvulas.....	663

Electricidad Volvo - Pág. 637 a 642

Alternadores.....	638 a 640
Motores de arranque.....	637,638
Motores trim/tilt.....	641,642
Reles.....	641
Solenoides.....	640

Refrigeración Volvo - Pág. 650 a 662

Juegos de juntas.....	654,655,657 a 662
-----------------------	-------------------

Alojamientos termostatos	660
Bombas de agua	650
Cigüeñales/kits	663
Colectores/codos y otros	654 a 659
Correas	653
Despieces	654,655
Impulsores/kits	651-652
Manguitos	650,653,660
Termostatos/kits	660 a 662
Turbos	683

Transmisión Volvo - Pág. 674 a 680

Anodos	678,679
Aros tóricos	680
Bloqueador de colas	675
Cardan	676
Cojinetes cardan	676
Dampers	674
Fuelles/kits	675
Hélices	710
Latiguillos	674
Retenes de aceite	680
Retenes/kits	679,680
Tuercas hélices/kits	676,677

YANMAR - Pág. 363,364,369 a 373

Alternador	363,369 a 371
Motor de arranque	364,369 a 371
Filtros Aceite y Gasoil	373
Turbos	372

HONDA FUERABORDA - Pág. 15 a 28

Combustible Honda - Pág. 16 a 18

Conector de combustible	18
Bombas manuales de combustible (peras)	18
Filtros de combustible/kits	18
Lineas de combustible	18

Componentes internos Honda - Pág. 23 a 25

Cojinetes	23
Filtros de aceite	23,24
Juntas	22,23

Electricidad Honda - Pág. 16

Motores de arranque	16
Motores trim/tilt	16

Encendido Honda - Pág. 15

Cables de bujías/kits	15
-----------------------------	----

Refrigeración Honda - Pág. 19 a 23

Impulsores/kits de reparación	20,21
-------------------------------------	-------

Tabla indentificación modelos Honda - Pág. 15

Transmisión Honda - Pág. 24,25

Ánodos	24
Hélices	707,708
Kits de retenes	25
Retenes de aceite	25
Tuercas de hélices/kits	24

JOHNSON / EVINRUDE - Pág. 28 a 129

Combustible Johnson/Evinrude - Pág. 44 a 54

Bombas de combustible/kits	47 a 49
Bombas manuales de combustible (peras)	52
Conectores de combustible	52
Filtros de combustible	50-51

Kits carburador y productos relacionados	44 a 47
Lineas de combustible	52
Manguera de combustible	52
Separadores agua/combustible y soportes	49-50

Componentes internos Johnson/Evinrude - Pág. 68 a 91

Bielas	71-72
Cojinetes/kits	72 a 75
Filtros de aceite	76
Juntas de culata	81 a 83
Juntas/juegos	76 a 91
Pistones/aros	68 a 71
Retenes cigüeñal	75

Electricidad Johnson/Evinrude - Pág. 37 a 44

Motores de arranque	41 a 44
Motores trim/tilt	37
Rectificadores/reguladores	40
Solenoides	38-39
Stators	37

Encendido Johnson/Evinrude - Pág. 29 a 37

Bobinas	30 a 32
Bujías	127 a 129
Cableados bujías/Kits	35-36
Cajas de encendido	32 a 35
Condensadores	29
Juegos de contactos	29
Kits de encendido	29-30

Refrigeración Johnson/Evinrude - Pág. 54 a 67

Despieces	66 -67
Bombas de agua alojamiento/Kits	56 a 64
Impulsores/kits	54 a 57
Termostatos/kits	64-65

Tabla identificación modelos johnson/evinrude - Pág. 28-29

Sistema de arranque Johnson/evinrude - Pág. 91

Cuerda de arranque	91
Muelles de arranque	91
Uña arranque	91

Transmisión Johnson/Evinrude - Pág. 92 a 126

Ánodos	116
Arandelas/Espaciadores	103 a 105, 114-115
Aros	123 a 126
Cables de acelerador	114
Cojinetes acoplamiento y retenedores	105 a 108
Colas y alojamientos	102
Despieces	92 a 101
Ejes hélice	108-109
Ejes transmisión	102
Engranajes/juegos	92 a 101, 110 a 113
Hélices	708 a 710
Retenes de aceite	120-122
Retenes/Kits	116-119
Tuercas hélices/kits	103 a 105

MERCURY/MARINER - Pág. 131 a 237

Combustible Mercury/Mariner - Pág. 150 a 166

Bombas de combustible/Kits	157 a 158
Bombas de combustible (peras)	160-161
Conectores de combustible	161
Filtros de aire	166
Filtros de combustible	163 a 166
Kits de carburador	151 a 157
Lineas de combustible	159-160
Separadores agua/combustible y soporte	163

Componentes internos Mercury/Mariner - Pág. 178 a 200

Cojinetes.....	181 a 185
Filtros de aceite	186
Juntas de culata	191 a 193
Juntas/juegos	186 a 199
Pistones/aros	178 a 181
Silentblocks	186

Electricidad Mercury/Mariner - Pág. 138 a 151

Alternadores	147
Correas.....	147
Motores de arranque	147 a 151
Motores trim/tilt.....	139-140
Reguladores de voltaje.....	143
Reles	144
Solenoides.....	143 a 146
Stators	140 a 142
Triggers	141-142

Encendido Mercury/Mariner - Pág. 132 a 138

Bobinas.....	133-134
Bujías.....	230-237
Cableados bujías/Kits.....	137-138
Cajas interruptor.....	134
Condensadores	133
Kits de encendido.....	132
Llaves de arranque.....	138

Refrigeración Mercury/Mariner - Pág. 166 a 177

Bombas de agua alojamientos/kits.....	168 a 173
Impulsores/kits de reparación.....	167 a 170
Termostatos/kits.....	166-167

Tabla identificación modelos Mercury/Mariner - Pág. 131-132

Arranque Mercury/Mariner - Pág. 200

Cuerdas de arranque.....	200
Muelles	200

Transmisión Mercury/Mariner - Pág. 202 a 229

Acoples selector	213-214
Ánodos	216-217
Aros	225 a 229
Cojinetes/kits	208 a 211
Colas/carcasas	213
Despieces.....	202 a 207
Ejes de hélice	213-214
Ejes.....	212
Engranajes/juegos.....	202 a 207
Hélices.....	704
Kits de retenes.....	217 a 227
Mangueras/látiguillos Power trim.....	215
Retenes de aceite.....	222
Tuercas hélices/kits	214-215

NISSAN-TOHATSU - Pág. 238 a 244

SUZUKI - Pág. 247 a 264

Combustible Suzuki - Pág. 249 a 253

Kits de carburador	249-250
Bombas manuales de combustible (peras).....	251
Conectores de combustible	251 a 252
Filtros de combustible.....	250
Separadores agua/combustible.....	250

Componentes internos Suzuki - Pág. 256 a 258

Bielas.....	256
Cojinetes.....	256
Filtros de aceite	257
Juntas de culata	256-257
Pistones/aros.....	256

Electricidad Suzuki - Pág. 248-249

Motores de arranque 248-249

Encendido Suzuki - Pág.247

Bujías..... 261 a 264
Cable de bujías/kits 247

Refrigeración Suzuki - Pág. 253

Impulsores/kits..... 253-254
Juntas bombas de agua 255

Tabla indentificación modelos Suzuki - Pág. 247

Transmisión Suzuki - Pág. 258 a 260

Ánodos 258
Aros 260
Hélices..... 705,706
Retenes de aceite..... 260
Retenes unidad inferior/kits 258 a 260
Tuercas para hélice/kits..... 258

YAMAHA - Pág. 265 a 338

Combustible Yamaha - Pág. 275

Bombas de combustible (peras)..... 279
Conectores de combustible 287
Diafragmas bombas de combustible 279-280
Filtros de combustible..... 283 a 285
Filtros separadores de agua/combustible..... 281-282
Líneas de combustible..... 286
Kits de carburador 275-279

Componentes internos Yamaha - Pág. 300 a 302

Aros 300-301
Bielas/Kits 301
Cojinetes/Kits..... 301
Filtros de aceite 301-302
Juntas/Kits 302 a 316
Juntas de culata 305 a 307
Pistones..... 300 a 302

Electricidad Yamaha - Pág. 269 275

Motores de arranque 269 a 271
Motores de Trim/Tilt..... 271 a 274

Encendido Yamaha - Pág. 265 a 269

Bobinas..... 265 a 267
Bujías..... 335 a 338
Cables de bujía/Kits..... 267

Refrigeración Yamaha - Pág. 288 a 299

Alojamientos bomba de agua/kits..... 289 a 297
Impulsores/kits..... 288 a 290

Tabla indentificación modelos Yamaha - Pág. 265

Transmisión Yamaha - Pág. 316 a 338

Ánodos 317
Aros 334
Cojinetes..... 316
Despieces..... 320 a 329
Ejes de hélice 316
Hélices..... 701 a 703
Retenes kits..... 330 a 334
Retenes aceite..... 334
Tuercas de hélice/kits..... 317-318



MOTORES FUERABORDA HIDEA

Amplia gama de motores fueraborda de 4 tiempos.

La gama cubre las potencias desde 2'5 hp a 25 hp con la novedad en breve de dos modelos de 40 y 60hp que próximamente estarán disponibles.

Todos los modelos están disponibles con eje corto o largo.

Opcionalmente disponen de arranque eléctrico y mando de control a distancia.

Incluyen de serie la línea de combustible y el depósito de combustible externo, excepto los modelos de 2'5hp y 4hp.

Disponemos de un amplio stock de recambios.

Disponemos de combinaciones de motores con neumáticas con el suelo de fibra, tablillas, aluminio o inflables. Consultenos.

Para cualquier duda o consulta contacte con el departamento de recambios,

recambios@pronautic.net

2,5HP

290000 Eje Corto

Modelo	290000
Potencia máxima (Kw):	1.8
Acelerador al máximo rango de funcionamiento (rpm) :	5250-5750
Tiempos:	4
Cilindros:	1
Desplazamiento (cm3):	72
Diámetro x Carrera:	54x31,5
Ratio compresión:	9.0:1
Largo x ancho x altura (mm):	623x345x1021
Peso (Kg):	17
Ratio engranajes:	27:13(2.08)
Posición engranajes:	N-A
Sistema encendido:	TCI
Sistema refrigeración:	Por agua
Sistema arranque:	Manual
Sistema control:	Caña de dirección
Capacidad depósito (L):	0.9

- Amplia gama de motores fueraborda de 4 tiempos.
- Todos los modelos están disponibles con eje corto o largo.
- Opcionalmente disponen de arranque Eléctrico y mando de control a distancia.
- Incluyen de serie la línea de combustible y el depósito de combustible externo, excepto los modelos de 2.5HP y 4HP.



4HP

290001 Eje Corto

5HP

290002 Eje Corto

290011 Eje Largo

Modelo	290001	290002 290011
Potencia máxima (Kw):	2.9	3.6
Acelerador al máximo rango de funcionamiento (rpm):	4500-5500	4500-5500
Tiempos:	4	4
Cilindros:	1	1
Desplazamiento (cm3):	112	112
Diámetro x Carrera:	59x41	59x41
Largo x ancho x altura (mm):	Eje C: 717x361x1029 Eje L:	717x361x1029 717x361x1156
Peso (Kg):	22	C: 22 - L: 24
Ratio engranajes:	27:13(2.08)	27:13(2.08)
Posición engranajes:	A-N-R	A-N-R
Sistema encendido:	TCI	TCI
Sistema refrigeración:	Por agua	Por agua
Sistema arranque:	Manual	Manual
Sistema control:	Caña de dirección	Caña de dirección
Capacidad depósito (L):		12



- Solicite información de Packs con neumáticas Protender.

8HP

290003 Eje Corto
290006 Eje Largo

9,9HP

290004 Eje Corto
290008 Eje Largo
290007 Eje Corto con arranque eléctrico y control remoto
290012 Eje Largo con arranque eléctrico y control remoto

Modelo	290003 290006	290004 - 290008 290007 - 290012
Potencia máxima (Kw):	5.9	7.2
Acelerador al máximo rango de funcionamiento (rpm):	4500-5500	4500-5500
Tiempos:	4	4
Cilindros:	2	2
Desplazamiento (cm3):	212	212
Ratio compresión:	9.4:1	9.4:1
Largo x ancho x altura: Eje C:	1038x360x1017	1038x360x1017
(mm): Eje L:	1038x360x1144	1038x360x1144
Peso (Kg):	C: 38 - L: 40	C: 38 - L: 40
Ratio engranajes:	27:13(2.08)	27:13(2.08)
Posición engranajes:	A-N-R	A-N-R
Sistema encendido:	CDI	CDI
Sistema refrigeración:	Por agua	Por agua
Sistema arranque:	Manual	Manual
Sistema control:	Caña de dirección	Caña de dirección
Capacidad depósito (L):	12 / opcional: 24	12 / opcional: 24



HIDEA

15HP

290009 Eje Corto con arranque eléctrico y control remoto
290017 Eje Largo con arranque eléctrico y control remoto

15HP

290005 Eje Corto
290010 Eje Largo

Modelo	290005 - 290010 290009 - 290017
Potencia máxima (Kw):	11
Acelerador al máximo rango de funcionamiento (rpm):	4500-5500
Tiempos:	4
Cilindros:	2
Desplazamiento (cm3):	323
Diámetro x Carrera:	59x59
Ratio compresión:	9.9:1
Largo x ancho x altura: Eje C:	1000x427x1080
(mm): Eje L:	1000x427x1207
Peso (Kg):	C: 49,5 - L: 51,5
Ratio engranajes:	27:13(2.08)
Posición engranajes:	A-N-R
Sistema encendido:	CDI
Sistema refrigeración:	Por agua
Sistema arranque:	Manual
Sistema control:	Caña de dirección
Capacidad depósito (L):	12 / opcional: 24



• Solicite información de Packs con neumáticas Protender.

- Amplia gama de motores fueraborda de 4 tiempos.
- Todos los modelos están disponibles con eje corto o largo.
- Opcionalmente disponen de arranque Eléctrico y mando de control a distancia.
- Incluyen de serie la línea de combustible y el depósito de combustible externo, excepto los modelos de 2,5HP y 4HP.



25HP

290013 - Eje Corto
290014 - Eje Largo

290015 - Eje Corto con arranque eléctrico y control remoto

290016 - Eje Largo con arranque eléctrico y control remoto

Modelo	290013 290014	290015 290016
Potencia máxima (Kw):	18,4	18,4
Acelerador al máximo rango de funcionamiento (rpm):	5000-6000	5000-6000
Tiempos:	4	4
Cilindros:	2	2
Desplazamiento (cm3):	498	498
Diámetro x Carrera:	65x75	65x75
Largo x ancho x altura: Eje C:	724x398x1154	724x398x1154
(mm): Eje L:	724x398x1281	724x398x1281
Peso (Kgr):	290013: 78 290014: 80	290015: 80 290016: 82
Ratio engranajes:	27:13(2.08)	27:13(2.08)
Posición engranajes:	A-N-R	A-N-R
Sistema encendido:	CDI	CDI
Sistema refrigeración:	Por agua	Por agua
Sistema arranque:	Manual	Eléctrico
Sistema control:	Caña de dirección	Remoto
Capacidad depósito (L):	24L. (Separado)	24L. (Separado)

- Solicite información de Packs con neumáticas Protender.



HIDEA



Protender



CONSULTE NUESTRA GAMA DE PACKS DE NEUMATICA CON MOTOR HIDEA

Honda número de identificación del modelo

	Fabricante	HP	Año modelo	Long. Eje.	Sistema dirección	Mercado
BF2	BF = Honda	Ej: 2	DX = 1999 DY = 2000 D1 = 2001 D2 = 2002 D3 = 2003 D4 = 2004 D5 = 2005 D6 = 2006 DK0 = 2007-sup	S = 15" L = 20"	H = Agarre acelerador C = Embrague Centrifugo	A = Americano

Ejemplo: BF2D1SCHA = Honda, 2 HP, 2001 Modelo, 15", Embrague centrifugo c/agarre acel, Americano

	Fabricante	Caract. Especiales	HP	Año Modelo	Long. eje	Sistema dirección	Arranque	Mercado
BF5-BF20	BF = Honda	P = High Thrust Propeller = Standard Propeller	Ej: 5 20	D1 = 2001 D2 = 2002 D3 = 2003 D4 = 2004 D5 = 2005 D6 = 2006 DK0 = 2007-sup	S = 15" L = 20" XL = 25"	H = Arranque Acelerador C = Embrague centrifugo	S = Electric = Manual T = Electric w/ Power Tilt	A = Americano



EXAMPLE: BFP5D1LHSA = Honda, High Thrust Prop., 5 HP, 2001 Model, 20", Throttle Grip, Elec. Start, American

	Fabricante	HP	Año modelo	Long. Eje	Sistema Dirección	Tilt & Trim	Mercado
BF25-BF225	BF = Honda	Ej: 25 115 225	AX = 1999 AY = 2000 A1 = 2001 A2 = 2002 A3 = 2003 A4 = 2004 A5 = 2005 A6 = 2006 K0 = 2007-sup	S = 15" L = 20" X = 25" XX = 30"	R = Control Remoto H = manual.	T = Tilt & Trim = Manual Tilt J = Jet Drive	A = Americano

Ejemplo: BF25A1LRTA = Honda, 25 HP, 2001 Modelo, 20", Control remoto, Tilt & Trim, America

NOTA: Después del modelo del año 2006 Honda Marine tiene designaciones de año específicas.

 <p>18-7494 BOBINA Reemplaza: 30520-PNA-007 para: 130/ 135/ 150/ 105 jet/ & 150 HP VTEC 1998-2007</p>	 <p>18-23251 BOBINA ENCENDIDO Reemplaza: 30520-PWC-003 Para: BF75(2007 & Sup), BF90(2007 & Sup)</p>	 <p>Pack. de 10</p> <p>18-5224 18-5224-9① CABLE DE BUJÍA TERMINAL</p>
---	--	--

 <p>18-5225 KIT CABLE BUJÍAS Kit incluye 25 ft. rolo 7 MM Hypalon cable encendido con núcleo Metálico y asesoramiento de los 3 diferentes acoples finales para motores fueraborda.</p>	 <p>18-5226 CABLE ENCENDIDO Conductor metálico 100' Bobina 7mm Hypalon</p>
---	---

 <p>Pack. de 10</p> <p>18-5750 18-5750-9① TAPA BUJÍAS UNIVER- SAL Se suministra completo con conector terminal</p>	 <p>18-5752 TAPA BUJÍAS UNIVERSAL (8mm)</p>
---	---

① Precio por pack

 <p>18-6475 ALTERNADOR Reemplaza: 31630-ZW5-003 Para: BF115 (1999 & sup), BF130 (1999-2004)</p>	 <p>18-6476 ALTERNADOR Reemplaza: 31630-ZY6-003 Para: BF135 & BF150 (2004 & Sup)</p>	 <p>18-6433 ARRANQUE FUERABORDA Reemplaza: 31200-ZV5-013 Para: 40 H.P. (1999-SUP)</p>	
 <p>18-6445 MOTOR DE ARRANQUE Reemplaza: Honda 31200-ZW9-802 Para: 8 & 9.9HP (2001 & Sup)</p>	 <p>18-6959 MOTOR DE ARRANQUE Reemplaza: 31200-ZY6-003, 31200-ZY9-003, 31200-ZY9A-0031 Para: 75-150HP 2004-2010</p>	 <p>18-15061 MOTOR ARRANQUE FUERABORDA Reemplaza: 31200-ZW1-004 Para: BF75-90(1997-06)</p>	
 <p>18-6258 MOTOR TILT/TRIM Reemplaza: 36120-ZV5-821 Para: BF35,BF40,BF45,BF50 (1992-2002)</p>	 <p>18-6793 MOTOR TRIM Reemplaza: 36120-ZV5-822 Para: 40,50 H.P. (2002-03)</p>	 <p>18-6865 TRIM COMPLETO Reemplaza: Honda Universal Para: motor con 3-Ataques Trim, 115-225HP Johnson/Evinrude</p>	 <p>18-6823 CABLEADO Reemplaza: Universal Convierte 3-Cables Tilt y Trim motores 2-Cable diseño</p>

SEPARADOR AGUA COMBUSTIBLE



Sierra ofrece una línea completa de 10 y 21 micrones filtros de separación de agua incluyendo cazoleta de drenaje filtros para proteger el motor de inyección de combustible y el carburador

Separadores de agua y combustible de Sierra quitan más del 99,8% de agua emulsionada de la gasolina. Sierra de filtros de 10 micras son más de un 90% de eficiencia en la eliminación de partículas tan pequeñas como 10 micrones. Todos los filtros de flujo 90 @ GPH para alimentar el motor que más consumen. Sierra filtros de 10 micrones se recomiendan para evitar daños sensibles al interior y exterior de los sistemas de inyección de combustible.

Sierra #	Honda #	Descripción
18-7947	17670-ZW1-030GH	Filtro y decantador
18-7948	17670-ZW1-801AH	Filtro y decantador
18-7720	16900-SR3-004	Filtro combustible
18-7786	16900-SA5-004	Kit filtro combustible
18-7785	16010-ST5-993	kit filtro combustible



SHIELDS MARINE HOSE



HIGH STANDARDS MEANS QUALITY ASSURED.

Shields Marine's complete range of hose solutions and accessories are designed to meet the demanding requirements of the marine environment.



ENSAMBLAJE DE LINEA DE COMBUSTIBLE DE LONG. 9'

3/8"
Línea combustible ensamb.

18-81042EP-1 *SILVERADO 4000 Premium* OE# 17700-ZW9-010
17700-ZW9-020



18-80400
TANQUE
CONECTOR

(SE VENDE SEPARADO)



18-80401
CONECTOR
COMBUSTIBLE

18-8005EP-1
BOMBA
COMBUSTIBLE

18-80403
CONECTOR
COMBUSTIBLE



*

*

COMPONENTES DE ENSAMBLAJE LÍNEA DE COMBUSTIBLE

Aplicación bomba Honda: 8, 9.9, 15, 25, 30, 40, 50, 75, 90, 115, 130 HP (2001-02)

* Tanques y motores sólo a modo ilustrativo.



Display Package

18-8002EP-1
18-8002EP-1-10①
BOMBA COMB.
1/4"

18-8004EP-1
18-8004EP-1-10①
BOMBA COMB.
5/16"
bomba gran capacidad

18-8005EP-1
18-8005EP-1-10①
BOMBA COMB.
3/8"
Reemplaza: 174512
bomba gran capacidad



18-38008
CONECTOR COMBUSTIBLE
Reemplaza: 17660-ZV5-902
Para: 3/8" manguera, Use con 18-80406



Display Package

18-80401
CONECTOR COMBUSTIBLE
Hembra conector de manguera, de estilo nuevo, 3/8" manguera, no se intercambiarán con OE's 5/16" conjuntos de manguera. Se acopla con 18-80400, salida del tanque



Display Package

18-80403
CONECTOR COMBUSTIBLE
Conector de manguera de 3/8 hembra con bloqueo rectangular post, no se intercambiarán con OE's 5/16" conjuntos de manguera. Para los modelos de motor: Para uso con nuestro 18-81042 conjunto de manguera de combustible, lado motor. Se acopla con 18-80407



Display Package

18-80400
CONECTOR TANQUE
Reemplaza: 16977-ZV5-A00
Salida del depósito macho, nuevo estilo, 1/4"NPT, latón chapado en níquel. Conector macho, para el tanque de combustible. Se acopla con 18-80401



Display Package

18-80406
CONECTOR COMBUSTIBLE
Reemplaza: 16977-ZV5-900
Macho de salida de depósito, estilo antiguo, 1/4" NPT.



Display Package

18-80407
CONECTOR COMBUSTIBLE
Reemplaza: 17710-ZW9-033
5/16"
Para: BF8-BF130 (2003)
Se acopla con 18-80403, 18-80408



Display Package

18-80408
CONECTOR COMBUSTIBLE
Reemplaza: 17650-ZW9-003
Hembra 5/16" conector rectangular con poste de retención. Se adapta a final de modelo del motor se acopla con 18-80407



Display Package

18-80420
CONECTOR COMBUSTIBLE
Reemplaza: 17650-921-003ZB
Para: BF5/BF8A 2001 y anteriores
Se acopla con 17710-881-00ZA

FILTRO COMB.



18-8226

18-7712

Ref No.	OE No.
18-7712	16910-GB2-005
18-8226	16910-ZV4-015



18-79908
FILTRO COMBUSTIBLE
Reemplaza: 16911-ZY3-010
Para: BF90(2007 & Sup), BF115(1997 & inf, 2002 & Sup), BF130(2002-04), BF135(2004 & sup), BF150(2004 & sup), BF175(2007 & sup), BF200(2002 & sup), BF225(2002 & sup), BF250(1997 & inf)

18-79909
FILTRO COMBUSTIBLE

Reemplaza: 16901-ZY3-003
Para: BF115D LA, BF115D XA, BF115D XCA, BF115DK1 LA, BF115DK1 XA, BF115DK1 XCA, BF135A4 LA, BF135A4 XA, BF135A4 XCA, BF135A5 LA, BF135A5 XA, BF135A5 XCA, BF135A6 LA, BF135A6 XA, BF135A6 XCA, BF135AK0 LA, BF135AK0 XA, BF135AK0 XCA, BF135AK2 LA, BF135AK2 XA, BF135AK2 XCA, BF150A4 LA, BF150 A4 XA, BF150A4 XCA, BF150A5 LA, BF150A5 XA, BF150A4 XCA, BF150A5 LA, BF150A5 XA, BF150A5 XCA, BF150A6 LA, BF150A6 XA, BF150A6 XCA, BF150AK0 LA, BF150AK0 LA, BF150AK0 XA, BF150AK0 XCA, BF175AK1 LA, BF175AK1 XA, BF175AK1 XCA, BF175AK2 LA, BF175AK2 XA, BF175AK2 XCA, BF200A2 LA, BF200A2 XA, BF200A2 XCA, BF200A2 XXA, BF200A2 XXCA, BF200A3 LA, BF200A3 XA, BF200A3 XCA, BF200A3 XXA, BF200A3 XXCA, BF200A4 LA, BF200A4 XA, BF200A4 XCA, BF200A4 XXA, BF200A4 XXCA, BF200A5 LA, BF200A5 XA, BF200A5 XCA, BF200 A5 XXCA, BF200A6 LA, BF200 A6 XA, BF200A6 XCA, BF200 A6 XXA, BF200AK0 LA, BF200AK0 XA, BF200AK0 XCA, BF200AK1 LA, BF200 AK1 XA, BF200AK1 XCA, BF200AK2 LA, BF200AK2 XA, BF200AK2 XCA





18-7657
SENSOR OXIGENO
Reemplaza: 35655-ZY3-013



18-7658
SENSOR OXIGENO
Reemplaza: 35655-ZY9-003



18-7659
SENSOR OXIGENO
Reemplaza: 35668-ZY6-003



NEW
18-32153
SENSOR OXIGENO
Reemplaza: 35655-ZY3-C01, 35655-ZZ5-004
Para: BF40D, BF50D, BF250A (1997 & ant), BF40DK2, BF50DK2, BF225AK1, BF225AK2 (2007 & sup)



18-25200
ARBOL DE LEVAS SENSOR
Reemplaza: 37500-PNB-003
Para: 75 hp MFI



NEW
18-7552
SENSOR, MAP
Reemplaza: 37830-PGK-A01
Para: BF135A 2004-2006, BF135AK0, BF150A 2004-2006, BF150AK0, BF200A 2002-2006, BF200AK0, BF225A 2002-2006, BF225AK0



NEW
18-7558
SENSOR
Reemplaza: 30530-PPL-A01
Para: BF135A 2004-2006, BF150 2004-2006



NEW
18-7559
SENSOR
Reemplaza: 30530-P8F-A01
Para: BF200A 2002-2006, BF200AK0, BF225 2002-2006, BF225AK0



18-7050
KIT CARB
Reemplaza: Honda Kit 1
Para: BF9.9(2000 & inf), BF15(2002 & inf)



18-7051
KIT CARB
Reemplaza: Honda Kit 2
Para: BF9.9(2001 & Sup), BF15(2003 & Sup)

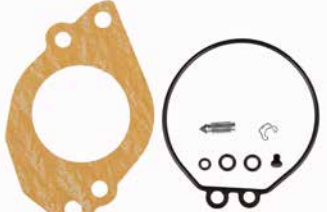

18-7052
KIT CARB
Reemplaza: Honda Kit 3
Para: BF75(1997 & sup), BF90(1997 & sup)

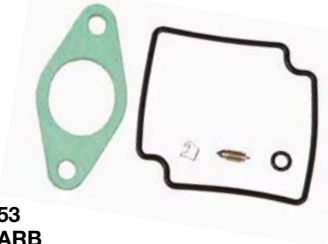

18-7053
KIT CARB
Reemplaza: Honda Kit 4
Para: BF8(2001 & sup), BF9.9(Todos), BF15(Todos), BF20(2003 & sup), BF25(todos), BF30(todos), BF35(1997), BF40(todos), BF45(1997), BF50(todos), BF75(1997 & sup), BF90(1997 & sup)



18-7047
VÁLVULA AGUJA
Reemplaza: 16011-ZV4-005
Para: BF8(2001 & sup), BF9.9(todos), BF15(todos), BF20(2003 & sup), BF25(todos), BF30(todos), BF35(1997), BF40(todos), BF45(1997), BF50(todos), BF75(1997 & sup), BF90(1997 & sup)



18-7048
VÁLVULA AGUJA
Reemplaza: 16011-881-741
Para: BF5(2003 & inf), BF8(todos), BF75(1997 & inf), BF100(1997 & inf)



18-3627
TERMOSTATO
Reemplaza: 19300-881-761
Para: BF5A1, BF5A2, BF5A3, BF5A4, BF5A5, BF5A6, BF5AH, BF5AK, BF5AK0, BF5AM, BF5AW, BF5AX, BF5AY, BF8A3, BF8A4, BF8A5, BF8A6, BF8AH, BF8AK, BF8AK0, BF8AM, BF8AW, BF8AX, BF8AY, BF9.9AH, BF9.9AK, BF9.9AM, BF9.9AW, BF9.9AX, BF9.9AY, BF15A1, BF15A2, BF15AH, BF15AK, BF15AM, BF15AW, BF15AX, BF15AY, BF50F, BF75E, BF75F, BF100E, BF100F 52°C



18-3628
TERMOSTATO
Reemplaza: 19300-ZW9-003
Para: BF8D1, BF8D2, BF8D3BF15D3, BF15D4, BF15D5, BF15D6, BF15DK0, BF20D3, BF20D4, BF20D5, BF20D6, BF20DK0, BF25D4, BF25D5, BF25D6, BF25DK0, BF30D4, BF30D5, BF30D6, BF30DK0, BF40A4, BF40A5, BF40A6, BF40AK0, BF40D, BF50A4, BF50A5, BF50A6, BF50AK0, BF50D, BF60A, BFP60A, BF75DK0, BF90DK0, BF200A2, BF225A2 60°C



18-3629
TERMOSTATO
Reemplaza: 19300-881-741
Para: BF8AM, BF8AW, BF8AX, BF8AY, BF8A3, BF8A4, BF8A5, BF8A6, BF8AK0, BF75, BF75A, BF75B, BF75C, BF75D, BF75E, BF75F, BF75K1, BF75K2, BF75K3, BF75Z, BF100, BF100A, BF100B, BF100C, BF100D, BF100E, BF100F, BF100Z 62°C

① Descuento en tienda en pack de 10 - Precio por pack

18-3630
TERMOSTATO

Reemplaza: 19300-ZV5-043
 Para: BF25A, BF25A1, BF25A2, BF25A3, BF25AW, BF25AX, BF25AY, BF30A, BF30A1, BF30A2, BF30A3, BF30AW, BF30AX, BF30AY, BF35AM, BF40A, BF40A1, BF40A2, BF40A3, BF40AW, BF40AX, BF40AY, BF45AM, BF50A, BF50A1, BF50A2, BF50A3, BF50AW, BF50AX, BF50AY, BF75A1, BF75A2, BF75A3, BF75A4, BF75A6, BF75AT, BF75AW, BF75AX, BF75AY, BF90A1, BF115A1, BF115A2, BF115AX, BF115AY, BF130A1, BF130A2, BF130AX, BF130AY 72°C



18-3031
IMPULSOR

Reemplaza: 19210-ZY3-003
 Para: BF200 & BF225 (2002 & sup)



18-3100
IMPULSOR

Reemplaza: 19210-ZW9-013, 19210-ZW9-003
 Para: BF8D/9.9D eje corto y largo



18-3056
18-3056-10②
IMPULSOR

Reemplaza: 19210-ZW1-003
 Para: 75-90 HP



18-3245
IMPULSOR

Reemplaza: 19210-881-A01, 19210-881-A02, 19210-ZW9-A02
 Para: 5, 7.5, 8, 10 HP



18-32455
IMPULSOR

Reemplaza: 19210-ZW9-A32, 19210-ZW9-A31
 Para: Honda 8 & 9.9 (2001 & sup); Honda 15 & 20 (2003 & sup)



18-3246
IMPULSOR

Reemplaza: 19210-ZV4-013, 19210-ZV4-651
 Para: BF9.9, BF15, AH, AK, AM, AW
 Series # 14ZV40M



18-3247
IMPULSOR

Reemplaza: 19210-ZV4-651
 Para: 8, 9.9, 15 HP



18-3248
IMPULSOR

Reemplaza: 19210-ZV5-003
 Para: 35, 40, 45, 50 HP



18-3249
IMPULSOR

Reemplaza: 19210-ZV7-003
 Para: 25, 30 HP



18-3250
IMPULSOR

Reemplaza: 19210-ZW1-B04
 Para: 75, 90, 115, 130 HP



18-3268
LLAVE IMPULSOR
Reemplaza: 90752-ZV4-650
 Para: BF9.9A, BF15A



18-3269
LLAVE IMPULSOR
Reemplaza: 90752-ZV7-000
 Para: BF25, BF30













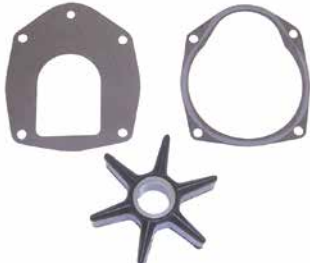



18-3270
LLAVE IMPULSOR
Reemplaza: 90752-ZV5-003
 Para: BF35, BF40, BF45, BF50

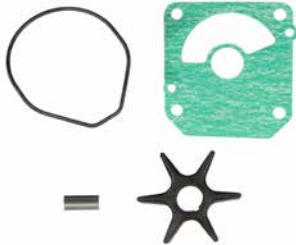

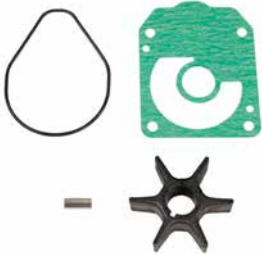
18-3271
LLAVE IMPULSOR
Reemplaza: 90752-ZW1-B02
 Para: BF75-BF90 AX & sup, BF115, BF130



 <p>18-3273 LLAVE IMPULSOR Reemplaza: 90752-ZY3-003 Para: BF200, BF225</p>	 <p>18-3122 PLATINA IMPULSOR Reemplaza: 19231-ZW1-003 Para: 75-90 HP</p>	 <p>18-3187 KIT REPARACIÓN IMPULSOR Reemplaza: 06192-ZW1-305 Para: BF75-90, (1996-98) Incluye impulsor 18-3056</p>
 <p>18-3214 KIT BOMBA AGUA Reemplaza: 19021-ZW1-003 Para: BF 70/BF 90 1996-98 Incluye impulsor 18-3056</p>	 <p>18-3278 KIT SERVICIO BOMBA AGUA Reemplaza: 06192-ZV1-C00 Para: BF5 Incluye impulsor 18-3245</p>	 <p>18-3279 KIT SERVICIO BOMBA DE AGUA Reemplaza: 06192-881-C00 Para: BF8A (USA) Incluye impulsor 18-3245</p>
 <p>18-3280 KIT SERVICIO BOMBA DE AGUA Reemplaza: 06192-ZV4-000 Para: BF9.9A/BF15A Incluye impulsor 18-3247</p>	 <p>18-3281 KIT SERVICIO BOMBA DE AGUA Reemplaza: 06192-ZV7-000 Para: BF25/30 Incluye impulsor 18-3249</p>	 <p>18-3282 KIT SERVICIO BOMBA DE AGUA Reemplaza: 06192-ZV5-003 Para: BF35/45, BF40/50 Incluye impulsor 18-3248</p>
 <p>18-3283 KIT SERVICIO BOMBA DE AGUA Reemplaza: 06192-ZW1-000 Para: BF115/130, BF75/90 AX & despues Incluye impulsor 18-3250</p>	 <p>18-3284 KIT SERVICIO BOMBA DE AGUA Reemplaza: 06192-ZY6-000 Para: BF135 / BF150 Incluye impulsor 18-3250</p>	 <p>18-3285 KIT SERVICIO BOMBA DE AGUA Reemplaza: 06192-ZY3-000 Para: BF200/225 Incluye impulsor 18-3031</p>
 <p>18-2495 JUNTA BOMBA DE AGUA Reemplaza: 19232-ZV4-610 Para: BF9.9A, BF15A</p>	 <p>18-2496 JUNTA BOMBA DE AGUA Reemplaza: 19233-ZV5-000 Para: BF25, BF30</p>	 <p>18-2499 JUNTA BOMBA DE AGUA Reemplaza: 19234-ZY3-000 Para: BF200, BF225</p>

① Referencias acabadas en "D" envasadas - referencia normal no envasada • ② descuento en tienda por pack de 10 - Precio por pack

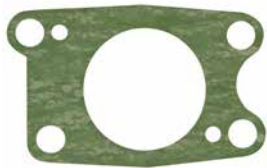

18-2524
JUNTA BOMBA AGUA
Reemplaza: 19232-ZV1-A10
Para: BF5



18-2608
JUNTA BOMBA AGUA
Reemplaza: 19232-881-850
Para: BF8A



18-2609
JUNTA BOMBA AGUA
Reemplaza: 19234-881-850
Para: BF8A



18-0176
JUNTA BOMBA AGUA
Reemplaza: 19242-ZV5-000

Pack. de 2



18-2563
18-2563-9 ①
JUNTA IMPULSOR
Reemplaza: 19232-ZW1-003

Pack. de 2



18-2564
18-2564-9 ①
JUNTA IMPULSOR
Reemplaza: 19234-ZW1-003

Pack. de 2



18-2565
18-2565-9 ①
JUNTA IMPULSOR
Reemplaza: 19242-ZW1-003

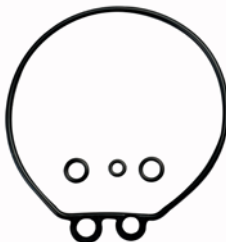

18-2480
CONJUNTO JUNTAS
Reemplaza: 16010-ZV4-005
Para: BF8(2001), BF9.9(2001 & inf),
BF15(2002 & inf), BF25(todos), BF30(todos),
BF35(1997), BF40(todos), BF45(1997),
BF50(todos), BF75(1997-06), BF90(1997-06)



18-2481
CONJUNTO JUNTAS
Reemplaza: 16010-ZW9-003
Para: BF8(2002 & sup), BF9.9(2002 & sup),
BF15(2003 & sup), BF20(2003 & sup)



18-2482
CONJUNTO JUNTAS
Reemplaza: 16010-881-003
Para: BF5(2003 & inf), BF8(2000 & inf, 2003 & sup), BF50(1996 & inf), BF75(1996 & inf), BF100(1996 & inf)



18-2470
JUNTA MONTAJE CARB.
Reemplaza: 16221-ZV4-610
Para: BF9.9 (2000 & inf), BF15 (2002 & inf)



18-2471
JUNTA MONTAJE CARB
Reemplaza: 16221-ZW9-000
BF8(2001 & Sup), BF9.9(2001 & Sup)



18-2472
JUNTA CARB MONTAJE
Reemplaza: 16221-ZW1-000
Para: BF75(1997-06), BF90(1997-06)

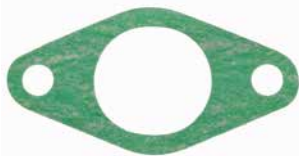

18-2473
JUNTA MONTAJE CARB.
Reemplaza: 16201-881-850
Para: BF8(2000 & inf, 2003 & sup),
BF75(1996 & inf), BF100(1996 & inf)

Pack. de 2



18-2945
18-2945-9 ①
18-29451-9 ①
(Pack. de 50)
JUNTA TORNILLO DRENAJE
Use con 18-2244 tornillo drenaje

 <p>18-0300 JUNTA COLECTOR AD- MISIÓN Reemplaza: 17105-ZY6-000 Para: BF135-BF150</p>	 <p>18-0390 JUNTA COLECTOR AD- MISIÓN Reemplaza: 17105-ZY3-004 Para: BF200-BF225 (2002 y SUP)</p>	 <p>18-0248 JUNTA COLECTOR ADMISIÓN Reemplaza: 17151-ZW5-000</p>
 <p>18-0382 JUNTA CUERPO ACELERADOR Reemplaza: 17109-ZY6-000 Para: BF75-BF150</p>	 <p>18-0396 JUNTA CUERPO ACELERADOR Reemplaza: 17109-ZY3-004 Para: BF200-BF225 (2002 & SUP)</p>	 <p>18-0737 JUNTA CUERPO ACELERADOR Reemplaza: 16176-P0A-004</p>
 <p>18-3288 RETÉN Reemplaza: 91252-ZV1-003 Para: BF5</p>	 <p>18-8298 RETÉN Reemplaza: 91252-935-004 Para: BF8A</p>	 <p>18-8299 RETÉN DE GOMA Reemplaza: 91356-ZY3-003 Para: BF200, BF225</p>
 <p>18-1156 COJINETE MARCHA ADELANTE Reemplaza: 91051-ZW1-003</p>	 <p>18-1157 COJINETE AGUJAS MARCHA ADELANTE Reemplaza: 91057-ZW1-003</p>	 <p>18-1158 COJINETE AGUJAS Reemplaza: 91053-ZW1-003</p>
 <p>18-7909 FILTRO ACEITE Reemplaza: 15400-POH-305PE, 15400-POH-305, 15400-ZJI-004, 15400-PLM-A01PE (Aplicación en la siguiente página)</p>	 <p>18-7913 FILTRO ACEITE Reemplaza: 15400-PFB-014 (Aplicación en la siguiente página)</p>	 <p>18-7911-1 FILTRO ACEITE Reemplaza: 15400-PFB-007 (Aplicación en la siguiente página)</p>

Modelos	AÑO	SS Num.	Reemplaza	Ref No.	Modelos	AÑO	SS Num.	Reemplaza	Ref No.
BF8D, BFP8D	2001-Actual	15400-PFB-004	15400-PFB-014	18-7913	BF50A	1998-Ant.	15400-PJ7-005	15400-PFB-014	18-7913
BF9D, BFP9D	2001-Actual	15400-PM3-004	15400-PFB-014	18-7913	BF25	1999-2005	15400-ZW4-003	15400-PFB-007	18-7911-1
BF15D, BFP15D	2003-Actual	15400-PM3-405	15400-PFB-014	18-7913	BF30	1999-2005	15400-ZW4-003	15400-PFB-007	18-7911-1
BF20D	2003-Actual	15400-PJ7-015	15400-PFB-014	18-7913	BF40	1999-2005	15400-ZW4-003	15400-PFB-007	18-7911-1
BF25A	1998-Ant.	15400-PJ7-005	15400-PFB-014	18-7913	BF50	1999-2005	15400-ZW4-003	15400-PFB-007	18-7911-1
BF30A	1998-Ant.	15400-PJ7-005	15400-PFB-014	18-7913	BF75, BF90	1997-Actual	15400-P0H-305PE	15400-PLM-A01PE	18-7909
BF35AM	1998-Ant.	15400-PJ7-005	15400-PFB-014	18-7913	BF115, BF130	1999-Actual	15400-P0H-305	15400-PLM-A01PE	18-7909
BF40A	1998-Ant.	15400-PJ7-005	15400-PFB-014	18-7913	BF135, BF150	2004-Actual	15400-ZJ1-004	15400-PLM-A01PE	18-7909
BF45AM	1998-Ant.	15400-PJ7-005	15400-PFB-014	18-7913	BF200, BF225	2002-Actual	15400-ZJ1-999AH	15400-PLM-A01PE	18-7909

**Zinc sólo para agua salada
Magnesio es para agua dulce
El aluminio es de agua salobre, o si el barco se utiliza tanto en los entornos de dulce y salada**



18-2448
KIT DRENAJE/LLENADO UNIDAD INF.
• M8 - 1.25 rosca
Para: Yamaha, Nissan/Tohatsu, & Honda unidad inferior



③ 009464
ANODO
Reemplaza: 41109-ZW1-003
BF75-BF90 (1997-98)



② 18-6241
③ 009354
① 18-6011A
ANODO
Reemplaza: 41107-ZW1-003ZA
BF75-BF90 (1997-98)



① 18-6165A
ANODO, TRIM
Reemplaza: 41107-ZV5-00-00
Para: BF25, BF30, BF35, BF45, BF50 (1997-Sup)



① 18-6163A
② 18-6163M
KIT ANODOS
Para: Honda BF90-115



Pack. de 10
18-3200
18-3200-9 ④
ARANDELA SUJECIÓN
Reemplaza: 90508-ZW1-003
Para: 75-90 HP



⑤ 18-3701D 

18-3701
KIT DE TUERCAS
— CONTIENE —
Ref # O.E. # Descripción
18-3200 90508-ZW1-003 Arandela suj.
18-3700 90301-ZW1-003 Tuercas



18-79989
STICKS ARRASTRE
Para: Mayoría fuerabordas 150hp con tilt/trim integral.

① Aluminio ② Magnesio ③ Zinc ④ Precio por pack
⑤ Referencias acabas en "D" envasadas - referencia normal no envasada

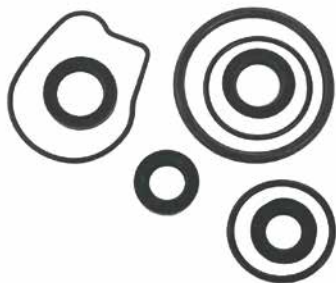

18-8362-1
KIT INFERIOR SELLADO
 Para: Series 14ZV50M



18-8363
KIT INFERIOR SELLADO

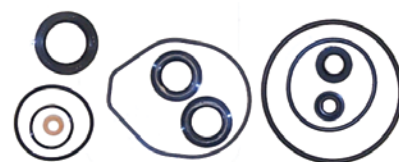

18-8365
KIT INFERIOR SELLADO

Pack. de 5



18-7198
18-7198-9④
ARO
 Reemplaza: 91353-ZW1-003



RETENES ACEITE

Ref No.	Descripción	O.E. No.
18-0522	EJE TRANSM	91254-ZW1-003
18-0583	EJE TRANSM	91251-ZW1-003
18-2002	EJE HÉLICE	91252-ZW1-003
18-2053	EJE HÉLICE	91255-ZW1-003
18-2054	EJE TRANSM	91253-ZW1-003

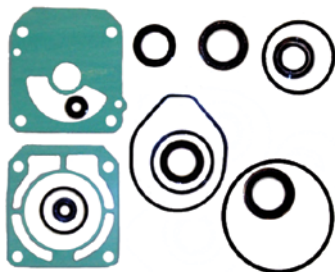

18-8366
KIT SELLADO UNIDAD INF.

APLICACIÓN DEL KIT DE SELLADO DE UNIDAD INFERIOR

HP/Modelo	Ref #
BF9.9, BF15	18-8363
BF35AM, BF45AM, BF40A, BF40AW, BF40AX, BF50A, BF50AW, BF50AX	18-8362-1
BF75, BF90	18-8366
BF115, BF130	18-8365



**THE
 VERY BEST
 PARTS OF
 BOATING**





HONDA

POTENCIA HP	AÑO	NGK	REF.PRONAUTIC	POTENCIA HP	AÑO	NGK	REF.PRONAUTIC
BF 2B 4T		CR5HSB	050605	BF 25/A 4T	1993+	DR7EA	050824
BF 2D 4T	1999+	CR5HSB	050605	BF 25B 4T		DR7EA	050824
BF 2/A 4T	1984+	BMR4A	050841	BF 25D4 4T	2004+	DR7EA	050824
BF 2B 4T		CR5HSB	050605	BF 28 4T		CR5HSB	050605
BF2.3 4T		CR5HSB	050605	BF 28D 4T		CR5HSB	050605
BF 4.5B 4T		BPR5ES	050825	BF 30/A 4T	1994+	DR7EA	050824
BF 5AK		BPR5ES	050825	BF 30D4 4T	2004+	DR7EA	050824
BF 5 4T	1984+	BPR5ES	050825	BF 35/A 4T	1990+	DR7EA	050824
BF 5A 4T		BPR5ES	050825	BF 40B 4T		DR7EA	050824
BF 6B 4T	2003+	DR4HS	050725	BF 40/A 4T	1994+	DR7EA	050824
BF6 4T		DR4HS	050725	BF 45/A 4T	1990+	DR7EA	050824
BF6CH 4T	2004+	CR5EH-9	050890	BF 50/F 4T	1985-1994	BPR5ES	050825
BF 7,5 4T	1977+	DR5HS	050852	BF 50 4T	1986-1994	BPR5ES	050825
BF 8 4T	2001+	CR5EH-9	050890	BF 50/A 4T	1994+	DR7EA	050824
BF 8D 4T		CR5EH-9	050890	BF 70A 4T		DR7EA	050824
BF 8D1 8.0HP 4T	2001+	CR5EH-9	050890	BF 75 4T	2003+	DR7EA	050824
BF 8 4T	1987-2000	DR5HS	050852	BF 75B 4T		DR7EA	050824
BF 8 A/B/C 4T	1990-2000	DR5HS	050852	BF 75E 4T		DR5HS	050852
BF 8B1 4T		CR5EH-9	050890	BF 75A 4T	1995+	DR7EA	050824
BF 9/A 4T		DR5HS	050852	BF 75 4T		DR5HS	050852
BF 9.9 4T	1987-2001	DR5HS	050852	BF 90/A 4T	1995+	DR7EA	050824
BF 9.9 A/B 4T		DR5HS	050852	BF 100E 4T		DR5HS	050852
BF 9.9D1 9.9HP 4T	2001+	CR5EH-9	050890	BF 100 4T		DR5HS	050852
BF 10D 4T	2001+	CR5EH-9	050890	BF 115/A 4T	1998+	DR5HS	050852
BF 10/B1 4T	2001+	CR5EH-9	050890	BF 130A 4T	1998+	DR5HS	050852
BF 15D 4T	2003+	CR5EH-9	050890	BF 135A 4T		IZFR6K11	050726
BF 15B 4T		DR5HS	050852	BF 150A 4T		IZFR6K11	050726
BF 15 4T	1987-1990	DR6HS	050851	BF 175A 4T		IZFR6K11	050726
BF 15A 4T	1996-2002	DR5HS	050852	BF 200A V6	2002+	IZFR6K11	050726
BF 20 4T	1993+	DR7EA	050824	BF 225A V6	2002+	IZFR6K11	050726
BF 20/F 4T	1985+	BMR4A	050841				
BF 20D 4T	2003+	CR5EH-9	050890				



HONDA

POTENCIA HP	CHAMPION	REF.PRONAUTIC
2HP BF2A,D	CJ14	050986
5HP OHC 4 T BF5A	RN11YC4	050970
7.5HP B75	P10Y	050958
8.0HP OHC 4 T BF8A	P10Y	050958
9.9HP BF9.9A	P10Y	050958
15HP OHC 4 T BF15A	P8Y	050964
20HP BF20A	RA6HC	050987
25HP OHC 4 T BF25A	RA8HC	050957
30HP OHC 4 T BF30A	RA8HC	050957
35HP BF35A	RA8HC	050957
40HP OHC 4 T BF40A	RA8HC	050957
45HP BF45A	RA8HC	050957
50HP OHC 4 T BF50A	RA8HC	050957
70HP OHC 4 T BF70A	RA8HC	050957
75HP BF75A	RA8HC	050957
90HP OHC 4 T BF90A	RA8HC	050957
115HP OHC 4 T	RC9MC4	051026
130HP OHC 4 T	RC9MC4	051026
150HP BF150	RC9MC4	051026
BF200, 225	RC9MC4	051026

Johnson/Evinrude Modelo identificación

Fueraborda 1980-1998

Modelo Variación	Estilo	HP	FUNCIÓN DISEÑO	Eje año Longitud	construido
A = Australia B = Bélgica C = Canada H = Hong Kong S = Sud África T = Tracker V = Boat Builder	J = Johnson E = Evinrude C = Commercial V = Quiet Rider	Ejemplo: 20 40 200	AE = Arranque eléctrico - Alaska AR = Arranque Manual - Alaska BA = AC Luz - Arranque manual BE = Belgium Derated - arranq. elect. BF = Belgium Derated - Arranque manual BG = Belgium Derated - Arranque manual BI = Belgium Derated - Arranque manual BR = Euro arranque manual C = Contra rotación CE = Canada Derated - Arranq.elect CR = Canada Derated - Arranq. manual D = Eléctrico remoto DE = Derated - Arranque elect DR = Derated - Arranque manual DT = Derated - Arranque elect/Trim & Tilt E = Arranque elect ER = Arranque elect - Sport Styling ES = Arranque elect- Especial FA = 4-tiempos - Arranque manual FE = 4-tiempos - arranque elect/Remoto FP = Comercial programa Tilt FR = 4-tiempos - Arranque manual FRE = 4-tiempos - Arranque electrico/Remoto FS = FICHT - Trim & Tilt FT = FICHT - Trim & Tilt/Especial G = Estilo especial H = Dirección hidráulica I = FICHT Inyección combustible IE = Italy arranque eléctrico IK = Italy arranque eléctrico J = Jet Drive K = 3-CIL 25/35 KC = Kerosene arranque manual KG = Kerosene/Gasolina KS = Kerosene Arranque manual M = Manual Tilt - Arranque elect MS = Manual Tilt - Arranque elect/Special N = Contra rotación P = Dirección power Q = 3-CIL 25/35 Trim & Tilt R = Arranq. manual RA = Australia arranq.manual RC = Arranq. manual - Comercial/CD Encend. RD = Arranq.manual - Deluxe RE = Eléctrico remoto RP = Comercial con Programa Tilt RS = Arranque manual - Comercial RW = Comercial con Programa Tilt S = Velero - Estilo especial SC = Estilo especial/Contra rotación SE = Arranq. elect. velero No-Tilt SI = Italy Special Derated SL = 60 grados V - Trim & Tilt SP = Estilo especial SR = Arranq. manual - velero - No-Tilt ST = Estilo especial - Trim & Tilt T = Trim & Tilt - Elec. Start TE = Tiller Elec. TR = Trim & Tilt - Sport styling TT = Tiller - Trim & Tilt U = Manual Tilt V = Caja engranajes especial W = 110 grados Angle Drive - Arranq. manual WM = Elec. Comercial - Manual Tilt WMP = Igual que "WM" con bomba cromada WT = Elec. Comercial - Trim & Tilt WTP = Igual que "WT" con bomba cromada	= 15" L = 20" Y = 22.5" X = 25" Z = 30"	I = 1 N = 2 T = 3 R = 4 O = 5 D = 6 U = 7 C = 8 E = 9 S = 0 EX: CS = 1980 ES = 1990 EU = 1997 SC = 2008

Ejemplo: VE70TLEDA - Modelo astillero, Evinrude, 70 HP, Trim & Tilt con arranque eléctrico, 1996 Modelo

Gráfico de identificación de modelo continúa en la página siguiente

Johnson/Evinrude Modelo identificación

FUERABORDAS 1999 Y NUEVOS

Estilo	HP	Función diseño	Long. eje.	Año
J = Johnson E = Evinrude	Example: 20 40 200	3 = 3-CIL (25 or 35 HP) 4 = Motor 4 tiempos B = Pintura azul C = Contra-Rotación con Trim & Tilt D = E-TEC E = Arranque eléctrico con dirección remota F = FICHT Inyección comb G = Pintura grafito J = Jet M = Modelo militar P = Power Trim y Tilt R = Arranque manual con dirección triller S = Tipo especial (Evinrude blanco) T = Tiller dirección TE = Tiller Electrico W = Modelo comercial	= 15" L = 20" Y = 22.5" X = 25" Z = 30"	I = 1 N = 2 T = 3 R = 4 O = 5 D = 6 U = 7 C = 8 E = 9 S = 0 EX: EE = 1999 SC = 2008

Ejemplo: E70PLEEA - Evinrude modelo, 70 HP, Power Trim&Tilt, 20", 1999 modelo

<p style="text-align: right;">①18-5001D Display Package</p>  <p>18-5001 KIT ENCENDIDO Reemplaza: 172525</p> <p style="text-align: center;">— CONTIENE —</p> <table border="1"> <thead> <tr> <th>Ref #</th> <th>Desc.</th> <th>O.E.#</th> <th>Cant.</th> </tr> </thead> <tbody> <tr> <td>18-5200</td> <td>Condensador</td> <td>580256</td> <td>1</td> </tr> <tr> <td>18-5157</td> <td>Conjunto contacto</td> <td>580290</td> <td>2</td> </tr> </tbody> </table>	Ref #	Desc.	O.E.#	Cant.	18-5200	Condensador	580256	1	18-5157	Conjunto contacto	580290	2	<p style="text-align: right;">①18-5002D Display Package</p>  <p>18-5002 KIT ENCENDIDO Reemplaza: 172523</p> <p style="text-align: center;">— CONTIENE —</p> <table border="1"> <thead> <tr> <th>Ref #</th> <th>Desc.</th> <th>O.E.#</th> <th>Cant.</th> </tr> </thead> <tbody> <tr> <td>18-5205</td> <td>Condensador</td> <td>581419</td> <td>2</td> </tr> <tr> <td>18-5156</td> <td>Conjunto contacto</td> <td>580148</td> <td>2</td> </tr> </tbody> </table>	Ref #	Desc.	O.E.#	Cant.	18-5205	Condensador	581419	2	18-5156	Conjunto contacto	580148	2	<p style="text-align: right;">①18-5003D Display Package</p>  <p>18-5003 KIT ENCENDIDO Reemplaza: 172806</p> <p style="text-align: center;">— CONTIENE —</p> <table border="1"> <thead> <tr> <th>Ref #</th> <th>Desc.</th> <th>O.E.#</th> <th>Cant.</th> </tr> </thead> <tbody> <tr> <td>18-5205</td> <td>Condensador</td> <td>581419</td> <td>2</td> </tr> <tr> <td>18-5141</td> <td>Conjunto contacto</td> <td>581207</td> <td>2</td> </tr> </tbody> </table>	Ref #	Desc.	O.E.#	Cant.	18-5205	Condensador	581419	2	18-5141	Conjunto contacto	581207	2
Ref #	Desc.	O.E.#	Cant.																																			
18-5200	Condensador	580256	1																																			
18-5157	Conjunto contacto	580290	2																																			
Ref #	Desc.	O.E.#	Cant.																																			
18-5205	Condensador	581419	2																																			
18-5156	Conjunto contacto	580148	2																																			
Ref #	Desc.	O.E.#	Cant.																																			
18-5205	Condensador	581419	2																																			
18-5141	Conjunto contacto	581207	2																																			
<p style="text-align: right;">①18-5006D Display Package</p>  <p>18-5006 KIT ENCENDIDO Reemplaza: 172522</p> <p style="text-align: center;">— CONTIENE —</p> <table border="1"> <thead> <tr> <th>Ref #</th> <th>Desc.</th> <th>O.E.#</th> <th>Cant.</th> </tr> </thead> <tbody> <tr> <td>18-5199</td> <td>Condensador</td> <td>580321</td> <td>2</td> </tr> <tr> <td>18-5156</td> <td>Conjunto contacto</td> <td>580148</td> <td>1</td> </tr> </tbody> </table>	Ref #	Desc.	O.E.#	Cant.	18-5199	Condensador	580321	2	18-5156	Conjunto contacto	580148	1	<p style="text-align: right;">①18-5011 Display Package</p>  <p>18-5011 KIT ENCENDIDO Reemplaza: 172521</p> <p style="text-align: center;">— CONTIENE —</p> <table border="1"> <thead> <tr> <th>Ref #</th> <th>Desc.</th> <th>O.E.#</th> <th>Cant.</th> </tr> </thead> <tbody> <tr> <td>18-5199</td> <td>Condensador</td> <td>580321</td> <td>1</td> </tr> <tr> <td>18-5156</td> <td>Conjunto cont.</td> <td>580148</td> <td>1</td> </tr> </tbody> </table>	Ref #	Desc.	O.E.#	Cant.	18-5199	Condensador	580321	1	18-5156	Conjunto cont.	580148	1	 <p>18-5141 CONJUNTO CONTACTOS Reemplaza: 581207</p>												
Ref #	Desc.	O.E.#	Cant.																																			
18-5199	Condensador	580321	2																																			
18-5156	Conjunto contacto	580148	1																																			
Ref #	Desc.	O.E.#	Cant.																																			
18-5199	Condensador	580321	1																																			
18-5156	Conjunto cont.	580148	1																																			
 <p>18-5156 CONJUNTO CONTACTO Reemplaza: 580148</p>	 <p>18-5157 CONJUNTO CONTACTO Reemplaza: 580290</p>	 <p>CONDENSADOR 18-5199 Reemplaza: 580321 18-5205 Reemplaza: 581419</p>	 <p>18-5200 CONDENSADOR Reemplaza: 580256</p>																																			

APLICACIONES EN LA SIGUIENTE PÁGINA

① referencias acabadas en "D" envasadas - Referencia normal no envasada

JOHNSON/EVINRUDE APLICACIÓN KIT ENCENDIDO

HP	Año inicial	Año final	Conjunto contacto	Condensador	Kit encendido	HP	Año inicial	Año final	Conjunto contacto	Condensador	Kit encendido
1.2	1986	1990	18-5156	18-5199	18-5011	25	1955	1955	18-5156	18-5199	18-5006
1.5	1968	1970	18-5156	18-5199	18-5011	25	1969	1976	18-5156	18-5205	18-5002
2	1971	1985	18-5156	18-5199	18-5011	28	1962	1964	18-5156	18-5205	18-5002
3	1952	1968	18-5156	18-5199	18-5006	30	1956	1956	18-5156	18-5199	18-5006
3	1989	1990	18-5156	18-5199	18-5006	33	1965	1970	18-5156	18-5205	18-5002
4	1969	1976	18-5156	18-5199	18-5006	35	1958	1959	18-5156	18-5199	18-5006
4	1981	1988	18-5156	18-5199	18-5006	35	1976	1976	18-5141	18-5205	18-5003
5	1965	1968	18-5156	18-5199	18-5006	38	1968	1968	18-5156	18-5199	18-5006
5.5	1954	1964	18-5156	18-5199	18-5006	40	1960	1961	18-5156	18-5199	18-5006
6	1965	1976	18-5156	18-5199	18-5006	40	1962	1973	18-5156	18-5205	18-5002
7.5	1956	1958	18-5156	18-5199	18-5006	40	1974	1976	18-5141	18-5205	18-5003
9.5	1964	1973	18-5156	18-5199	18-5006	40 Comm	1981	1983	18-5141	18-5205	18-5003
10	1950	1963	18-5156	18-5199	18-5006	50	1958	1959	18-5157	18-5200	18-5001
9.9	1970	1970	18-5156	18-5199	18-5006	60	1964	1967	18-5157	18-5200	18-5001
9.9	1974	1976	18-5141	18-5205	18-5003	75	1961	1967	18-5157	18-5200	18-5001
15	1956	1956	18-5156	18-5199	18-5006	80	1966	1967	18-5157	18-5200	18-5001
15	1974	1976	18-5141	18-5205	18-5003	90	1964	1965	18-5157	18-5200	18-5001
18	1956	1961	18-5156	18-5199	18-5006	90	1968	1968	18-5157	18-5200	18-5001
18	1962	1973	18-5156	18-5205	18-5002	100	1966	1966	18-5157	18-5200	18-5001
20	1968	1973	18-5156	18-5205	18-5002						



18-5163
BOBINA ENCENDIDO
Reemplaza: 581130, 763809



18-5170
BOBINA ENCENDIDO
Reemplaza: 583740, 583298



18-5172
BOBINA ENCENDIDO
Reemplaza: 581786, 502881



18-5176
KIT BOBINA ENCENDIDO
Reemplaza: 582106, 582330 582366, 583737, 584561



18-5179
BOBINA ENCENDIDO
Reemplaza: 582508



18-5181
BOBINA ENCENDIDO
Reemplaza: 582995, 584477



18-5192
BOBINA ENCENDIDO
Reemplaza: 581610, 582091, 502888



18-5193
BOBINA ENCENDIDO
Reemplaza: 580740, 582382



18-5194
BOBINA ENCENDIDO
Reemplaza: 582160, 584632, 502890, 581032



18-5196
BOBINA ENCENDIDO
Reemplaza: 581407, 502880

APLICACIÓN COMIENZAN EN LA SIGUIENTE PÁGINA

① Referencias acabas en "D" envasadas - referencias normales no envasadas

JOHNSON/EVINRUDE APLICACIONES DE ENCENDIDO

HP	Año inic.	Año final	Bobina	cant.	HP	Año inic.	Año final	Bobina	cant.	HP	Año inic.	Año final	Bobina	cant.
2	1971	1973	18-5181	1	20	1966	1972	18-5181	2	60	1980	1984	18-5176	2
2	1975	1985	18-5181	1	20	1973	1973	18-5163	1	60	1985	1987	18-5179	3
2	1995	2001	18-5179	1	20	1985	1987	18-5179	2	60	1988	1988	18-5176	3
2.5	1987	1988	18-5170	1	20	1988	1988	18-5176	2	60	1989	2001	18-5179	3
3	1955	1968	18-5181	2	20	1989	1998	18-5179	2	65	1972	1973	18-5194	3
3	1989	1990	18-5181	2	25	1951	1953	18-5181	2	65	1984	1984	18-5176	3
3	1991	1997	18-5170	1	25	1955	1955	18-5181	2	65	1985	1988	18-5179	3
3	1998	2001	18-5179	1	25	1969	1972	18-5181	2	65	1989	1990	18-5176	3
3	2003	2005	18-5179	1	25	1973	1976	18-5163	1	65	1991	2001	18-5179	3
3.3	1995	1997	18-5179	1	25	1973	1976	18-5172	2	70	1974	1975	18-5194	3
4	1969	1976	18-5181	2	25	1977	1984	18-5176	2	70	1979	1984	18-5176	3
4	1977	1980	18-5176	2	25	1985	1987	18-5179	2	70	1985	1987	18-5179	3
4	1981	1988	18-5181	2	25	1988	1988	18-5176	2	70	1988	1988	18-5176	3
4	1986	1987	18-5179	2	25	1989	2005	18-5179	2	70	1989	2001	18-5179	3
4	1987	2001	18-5170	1	28	1962	1964	18-5181	2	75	1975	1975	18-5194	3
4	1988	1988	18-5176	2	28	1986	1996	18-5179	2	75	1979	1984	18-5176	3
4	1989	1996	18-5179	2	28	1995	1998	18-5170	1	75	1985	1987	18-5179	3
4.5	1980	1983	18-5176	2	30	1956	1956	18-5181	2	75	1988	1988	18-5176	3
5	1965	1968	18-5181	2	30	1984	1984	18-5176	2	75	2000	2001	18-5170	2
5	1996	1998	18-5170	1	30	1985	1987	18-5179	2	85	1969	1972	18-5193	1
5	1997	2001	18-5179	2	30	1988	1988	18-5176	2	85	1973	1975	18-5194	3
5.5	1954	1964	18-5181	2	30	1989	2005	18-5179	2	85	1976	1977	18-5192	4
6	1965	1976	18-5181	2	30	1999	2001	18-5170	1	85	1978	1980	18-5176	4
6	1977	1979	18-5176	2	33	1965	1970	18-5181	2	85	1991	1995	18-5179	4
6	1984	1984	18-5176	2	35	1957	1959	18-5181	2	88	1987	1987	18-5179	4
6	1985	1990	18-5179	2	35	1976	1976	18-5172	2	88	1988	1988	18-5176	4
6	1991	2005	18-5170	1	35	1977	1984	18-5176	2	88	1989	1996	18-5179	4
6	1997	2001	18-5179	2	35	1986	1987	18-5179	2	90	1981	1984	18-5176	4
6	2003	2004	18-5179	2	35	1988	1988	18-5176	2	90	1985	1987	18-5179	4
7.5	1954	1958	18-5181	2	35	1989	1994	18-5179	2	90	1988	1988	18-5176	4
7.5	1980	1983	18-5176	2	35	1996	1996	18-5179	2	90	1989	1998	18-5179	4
8	1984	1984	18-5176	2	40	1960	1973	18-5181	2	90	1995	2006	18-5170	2
8	1985	1990	18-5179	2	40	1974	1974	18-5196	2	100	1971	1972	18-5193	1
8	1991	2005	18-5170	1	40	1975	1979	18-5172	2	100	1979	1980	18-5176	4
9.5	1964	1973	18-5181	2	40	1983	1983	18-5172	2	100	1984	1984	18-5176	4
9.9	1974	1976	18-5196	2	40	1984	1984	18-5176	2	100	1985	1997	18-5179	4
9.9	1977	1984	18-5176	2	40	1985	1987	18-5179	2	100	1988	1988	18-5176	4
9.9	1985	1992	18-5179	2	40	1988	1988	18-5176	2	100	1998	2001	18-5170	2
9.9	1993	2001	18-5170	1	40	1989	2005	18-5170	1	105	1997	2001	18-5170	2
10	1949	1952	18-5181	2	40	1999	2001	18-5179	2	105	2003	2003	18-5170	2
10	1953	1953	18-5181	2	45	1986	1992	18-5179	2	110	1986	1987	18-5179	4
10	1954	1963	18-5181	2	45	1992	1997	18-5170	1	110	1988	1988	18-5176	4
10	2003	2007	18-5170	1	48	1987	1987	18-5179	2	110	1989	1989	18-5179	4
14	1988	1988	18-5179	2	48	1988	1988	18-5176	2	112	1994	1996	18-5179	4
14	1989	1989	18-5176	2	48	1989	1996	18-5170	1	115	1969	1970	18-5193	1
15	1953	1953	18-5181	2	50	1971	1975	18-5194	2	115	1973	1975	18-5194	4
15	1955	1956	18-5181	2	50	1979	1984	18-5176	2	115	1976	1977	18-5192	4
15	1965	1968	18-5181	2	50	1985	1987	18-5179	2	115	1978	1984	18-5176	4
15	1974	1976	18-5196	2	50	1988	1988	18-5176	2	115	1985	1985	18-5179	4
15	1977	1984	18-5176	2	50	1989	2005	18-5170	1	115	1990	1998	18-5179	4
15	1985	1992	18-5179	2	50	1995	1998	18-5179	2	115	1995	2006	18-5170	2
15	1993	2007	18-5170	1	55	1978	1984	18-5176	2	120	1985	1987	18-5179	4
18	1957	1972	18-5181	2	55	1985	1992	18-5179	2	120	1988	1988	18-5176	4
18	1973	1973	18-5163	1	55	1992	2005	18-5170	1	120	1989	1994	18-5179	4

APLICACIÓN CONTINUA EN LA SIGUIENTE PÁGINA

JOHNSON/EVINRUDE APLICACIÓN BOBINA ENCENDIDO (Cont.)

HP	Año inic.	Año final	Bobina	cant.	HP	Año inic.	Año final	Bobina	cant.	HP	Año inic.	Año final	Bobina	cant.
125	1971	1972	18-5193	1	150	1985	1991	18-5179	6	185	1989	1990	18-5179	6
125	1989	1990	18-5179	4	150	1988	1988	18-5176	6	185	1992	1994	18-5179	6
125	1992	1998	18-5179	4	150	1991	2006	18-5170	3	200	1976	1978	18-5192	6
130	1995	2001	18-5179	4	155	1984	1984	18-5176	6	200	1979	1983	18-5176	6
135	1973	1975	18-5194	4	155	1985	1985	18-5179	6	200	1986	2001	18-5179	6
135	1976	1976	18-5192	4	155	1987	1987	18-5179	6	200	1999	1999	18-5170	3
135	2000	2001	18-5170	2	155	1988	1988	18-5176	6	225	1986	2001	18-5179	6
140	1977	1977	18-5192	4	155	1989	1992	18-5179	6	225	1999	1999	18-5170	3
140	1978	1984	18-5176	4	175	1977	1978	18-5192	6	235	1978	1978	18-5192	6
140	1985	1987	18-5179	4	175	1979	1983	18-5176	6	235	1979	1984	18-5176	6
140	1988	1988	18-5176	4	175	1985	1991	18-5179	6	235	1985	1985	18-5179	6
140	1989	1994	18-5179	4	175	1991	2006	18-5170	3	250	1991	2001	18-5179	6
150	1978	1978	18-5192	6	185	1984	1984	18-5176	6	275	1985	1988	18-5179	6
150	1979	1984	18-5176	6	185	1985	1985	18-5179	6	300	1985	1995	18-5179	6



18-5753
CAJA ENCENDIDO
Reemplaza: 385391, 581731, 581311
(pack 4)



18-5754
CAJA ENCENDIDO
Reemplaza: 581726
(pack 3)



18-5755
CAJA ENCENDIDO
Reemplaza: 581397, 764708
(pack 2)



18-5756
CAJA ENCENDIDO
Reemplaza: 582056
El mismo que 18-5753 sin Hardware
Pack (1) agujeros



18-5757
CAJA DE ENCENDIDO
Reemplaza: 582057, 581713
El mismo que 18-5754 sin hardware
pack (2) agujeros



18-5758
CAJA DE ENCENDIDO
Reemplaza: 582453, 583380, 582452



18-5759
CAJA ENCENDIDO
Reemplaza: 582125, 581805



18-5760
CAJA ENCENDIDO
Reemplaza: 582138, 582400, 582642, 582556



18-5761
CAJA ENCENDIDO
Reemplaza: 583114



18-5762
CAJA ENCENDIDO
Reemplaza: 582115



18-5763
CAJA ENCENDIDO
Reemplaza: 582285, 583170



18-5764
CAJA ENCENDIDO
Reemplaza: 582261, 586696



18-5765
CAJA ENCENDIDO
Reemplaza: 396141



18-5766
CAJA ENCENDIDO
Reemplaza: 583748



18-5767
CAJA ENCENDIDO
Reemplaza: 584783



18-5768
CAJA ENCENDIDO
Reemplaza: 584908, 5001344



18-5770
CAJA ENCENDIDO
Reemplaza: 584028



18-5771
CAJA ENCENDIDO
Reemplaza: 584032



18-5772
CAJA ENCENDIDO
Reemplaza: 584041



18-5773
CAJA ENCENDIDO
Reemplaza: 584642, 763803



18-5774
CAJA ENCENDIDO
Reemplaza: 585145, 5004532



18-5780
CAJA ENCENDIDO
Reemplaza: 585189, 5004533



18-5781
CAJA ENCENDIDO
Reemplaza: 586661, 584636, 586212, 585114



18-5782
CAJA ENCENDIDO
Reemplaza: 582705, 763793



18-5783
CAJA ENCENDIDO
Reemplaza: 582811, 763794



18-5784
CAJA ENCENDIDO
Reemplaza: 583110



18-5785
CAJA ENCENDIDO
Reemplaza: 585261



18-5794
CAJA ENCENDIDO
Reemplaza: 584489, 584329, 583896, 584331



18-5883
CAJA ENCENDIDO
Reemplaza: 584488

APLICACIONES COMIENZAN EN LA SIGUIENTE HOJA



18-5885
CAJA ENCENDIDO
Reemplaza: 583865
Para: V-6 5800 rpm limite



18-5886
CAJA ENCENDIDO Y SENSOR
Reemplaza: 436367, 584122
Para: Los motores V6 con sensor óptico y funda azul en el módulo de alimentación. No usar con manga larga gris stator.



18-5887
CAJA ENCENDIDO
Reemplaza: 584985
Para: Los motores V6 con sensor óptico y funda gris sobre power pack. No usar con manga negra stator



18-5891
CAJA ENCENDIDO
Reemplaza: 583605
Para: 3 & 6 cil. 6700 rpm limite

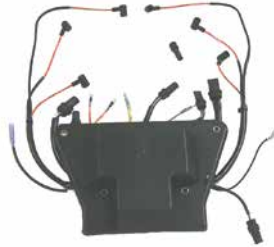

18-5893
CAJA ENCENDIDO
Reemplaza: 586667, 584037, 586217, 583476
Para: V-4 & V-8 6700 rpm limite



18-5884
SENSOR ÓPTICO
Reemplaza: 586343
Para: V-4 & V-6



18-9802
LUZ TIMING
Autoalimentado precisos hasta 10,000 RPM

Modelo	Años	Caja encendido	Modelo	Años	Caja encendido	Modelo	Años	Caja encendido
4	1977-80,1984	18-5758	25	1985	18-5765	48	1987-88	18-5763
4	1993	18-5883	25	1986-88	18-5763	48	1991-93	18-5794
4 DLX	1986-88, 1994-99	18-5763	25	1989-92	18-5794	50	1971-75	18-5755
4.5	1980-84	18-5758	25	1993-95	18-5768	50	1979,1981-84	18-5758
4.5	1986-87	18-5763	25	1996-01	18-5768 ⑩	50	1985	18-5765
5	1984	18-5758	25 COM.	1986-88	18-5764 ⑦	50	1986-88	18-5763
5	1985	18-5765	28	1986-88	18-5763	50	1991-93	18-5794
5	1986-88, 1993-98	18-5763	28	1989-92	18-5794	50 Arranq. manual	1993- 01	18-5768
6	1977-79,1984	18-5758	28	1996-01	18-5768	50 Arranq. elect	1993- 01	18-5785
6	1985	18-5765	30	1984	18-5758	50 (3 cil)	1996-99	18-5780 ⑧
6	1986-88, 1993-01	18-5763	30	1985	18-5765	55	1976-77	18-5755
6.5COM.	1992-99	18-5763	30	1986-88	18-5763	55	1978-82	18-5758
7.5	1980-83	18-5758	30	1989-92	18-5794	55	1991-92	18-5794
8	1993-95	18-5763	30	1993-95	18-5768	60	1970-71	—
9.9,15	1977-84	18-5758	30	1996-01	18-5768 ⑩	60	1980-84	18-5758
9.9,15	1985	18-5765	35	1977-84	18-5758	60	1985	18-5765
9.9,15	1986-88	18-5763	35	1985	18-5765	60	1986-88	18-5762 ⑧
9.9,15	1993-99	18-5767 ②	35	1986-88	18-5763	60	1989-92	18-5766
14	1987	18-5763	35	1989-92	18-5794	60	1993-95	18-5774 ⑧
10/15COM.	1992	18-5763	35	1993-95	18-5768	60	1996-99	18-5780 ⑧
10,15COM.	1993-99	18-5767	40	1982	18-5758	65	1972-73	18-5754 ③
20	1981-84	18-5758	40	1985	18-5765	65	1989-92	18-5766
20	1985	18-5765	40	1986-88	18-5763	65	1993-95	18-5774 ⑧
20	1986-88	18-5763	40	1991-93	18-5794	70	1974-78	18-5754 ③
20	1989-92	18-5794	40 Arranq. manual	1993- 01	18-5768	70	1979-84	18-5760
20	1993-95	18-5768	40 Arranq. eléct	1993- 01	18-5785	70	1985	18-5782 ⑧
20	1996-01	18-5768 ⑩	40 COM.	1986-88	18-5764	70	1986-88	18-5762 ⑧
25	1977-84	18-5758 ④	45	1991-92	18-5794	70	1989-92	18-5766

① 2 cajas encendido por motor
 ② Pida 18-5756 para Cajas encendido sin tapa, y tornillo de montaje
 ③ Pida 18-5757 para cajas encendido sin tapa, y tornillos de montaje

④ Todos los modelos excepto Worktwin, Workhorse y modelo comercial de 1983
 ⑤ Sólo para Babor 1983 modelo STLCT
 ⑥ Sólo para babor 1984 modelos con sufijo que empiece por "S"
 ⑦ 2 cil. sólo

⑧ 3 cil. sólo
 ⑨ Sea Drive Series
 ⑩ Excepto modelos remoto
 ❶ Consulte la imagen
 ❷ Sólo modelos 2 tiempos

Modelo	Años	Caja encendido	Modelo	Años	Caja encendido	Modelo	Años	Caja encendido
70	1993-95	18-5774 ⑧	110	1986-87	18-5784	185	1984	18-5760 ①
70	1996-99	18-5780 ⑧	110	1988	—	185	1990, 1992	18-5893
75	1975-78	18-5754 ③	115	1969-70	—	185	1993-99	18-5781
75	1979-84	18-5760	115	1973-77	18-5753 ②	200	1976-78	18-5754 ③ ①
75	1985	18-5782 ⑧	115	1978-84	18-5759 ①	200	1979-83	18-5760 ①
75	1986-88	18-5762 ⑧	115	1985	18-5783	200	1987	18-5891
85	1969-72	—	120	1986	—	200, 225	1988-92	18-5893
85	1973-77	18-5753 ②	120	1988-99	18-5772	200, 225	1993-99	18-5781
85	1978-80	18-5759 ①	125	1971-72	—	225	1987	18-5891
88, 90	1986-87	18-5784	130	1988-99	18-5772	235	1978	18-5754 ③ ①
88	1988	—	135	1973-76	18-5753 ②	235	1979-84	18-5760 ① ⑤ ⑥
88,90	1989-99 Crossflow	18-5770	140	1977	18-5753 ②	250	1991	18-5893
90	1981-83	18-5759 ①	140	1978-83	18-5759 ①	275	1986-87	—
90	1985	18-5783	140	1986	—	300	1987	—
90	1988	—	140	1988-99	18-5772	300	1991	18-5893
100	1971	—	150	197 -78	18-5754 ③ ①	V-8	1993-99	18-5773
100	19,681,972	—	175	1979-83	18-5760 ①	1.6L	1984 & prior	18-5759 ⑨
100	1979-80	18-5759 ①	175	1986-88	18-5761	1.6L	1985	18-5782
100	1988	—	175	1989-91	18-5885	1.6L	1986-87	18-5784
100, 115	1989-99 Crossflow	18-5770	175	1991-92	18-5886 ⑩	2.0L	1988-99	18-5772
110 (Sólo TCLDF)	1986	18-5783	175	1993-03	18-5887	2.5, 2.6L	1986-88	18-5761 ⑨

- ① 2 cajas encendido por motor
- ② Pida 18-5756 para Cajas encendido sin tapa, y tornillo de montaje
- ③ Pida 18-5757 para cajas encendido sin tapa, y tornillos de montaje

- ④ Todos los modelos excepto Worktwin, Workhorse y modelo comercial de 1983
- ⑤ Sólo para Babor 1983 modelo STLCT
- ⑥ Sólo para babor 1984 modelos con sufijo que empiece por "S"
- ⑦ 2 cil.sólo

- ⑧ 3 cil. sólo
- ⑨ Sea Drive Series
- ⑩ Excepto modelos remotos
- ⑪ Consulte la imagen
- ⑫ Sólo modelos 2 tiempos

CABLES DE BUJÍAS MARINOS DE ALTA CALIDAD

Sierra MAGFORCE protegen tus dispositivos electronicos, de los picos de tensión. Fácil instalación y larga vida.

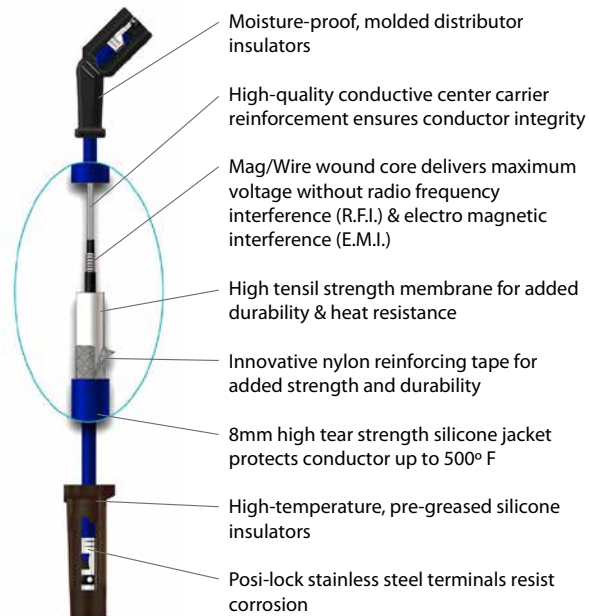

Ref #	OEM #	Descripción	Ref #	OEM #	Descripción
18-8815-1	OMC 582365	4" cable bujías	18-5230-9-1 ①③	Universal	10" cable bujías (pkg de 5)
18-8816-1	OMC 582365	6" cable bujías	18-8839-1	—	90 & 115 hp juego de cables fueraborda 2 - 14" • 2 - 16"
18-5231-1	OMC 582365	9" cable bujías	18-8840-1	—	150 & 175 hp juego cables fueraborda 2 - 14" • 2 - 16"
18-5231-1D ②	OMC 582365	9" cable bujías	18-28090	—	V6 Juego de cables fueraborda
18-8818-1	OMC 582365	12" cable bujías	18-28092	—	V4 Juego de cables fueraborda
18-5229-9-1 ①③	Universal	22" cable bujías (pkg de 5)			

Pack. de 10



18-5224
18-5224-9^①
CABLE TERMINAL ENCENDIDO
 Reemplaza: 510364



18-5225
KIT CABLE BUJÍAS
 Incluye 25 pies cable encendido Hypalon con conductor de cobre y un largo surtido de 3 terminales diferentes para motores Johnson/Evinrude.



18-5226
CABLE ENCENDIDO
 (100'bobina)
 Hypalon
 Reemplaza: 510883, 772584

Pack. de 10



18-5750
18-5750-9^①
TAPA BUJÍAS UNIVERSAL
 Suministro completo con conector terminal
 Reemplaza: 581027, 580339



18-5752
TAPA BUJÍAS UNIVERSAL
 8mm



MP39100
LLAVE ENCENDIDO
 Reemplaza: 386545
 (5 Terminales - 3 Posiciones)



MP39760
LLAVE ENCENDIDO
 Reemplaza: 393301, 508180
 (6 Terminales - Push to Choke - 3 Posiciones)



MP39830
LLAVE ENCENDIDO
 Reemplaza: 386545
 (6 Terminales - Pistol Shaped Key - 3 Posiciones)
 Pollak



MP28890
HOMBRE AL AGUA
 Reemplaza: 176288
 1996-Nuevo



18-1282
CABLE Y CLIP HOMBRE AL AGUA
 Reemplaza: 398602
 Tiller Steer Modelos - Todos



MP28870
MP28872 (Bulk - 100 pc/carton)
CABLE Y CLIP HOMBRE AL AGUA
 Reemplaza: 585134



MP28880
CABLE HOMBRE AL AGUA
 Reemplaza: 432230
 1995-antiguo

① Precio por pack

② Referencias acabadas en "D" envasados - Referencia normal no envasados

③ Use 7mm Núcleo de cobre



MP28900*
CABLE
Reemplaza: 432230
1995-antiguo



18-5877
STATOR
Reemplaza: 584643, 763779
Para: 185-300 HP (1993-2001)



18-5878
STATOR
Reemplaza: 584981, 763759
Para: 150-175 HP (1993-2006)

JOHNSON/EVINRUDE APLICACIONES STATOR			
HP	Año inicial	Año final	Stator
185	1993	1994	18-5877
200	1993	2001	18-5877
225	1993	2001	18-5877
250	1993	2001	18-5877
300	1993	1995	18-5877
150	1993	2006	18-5878
175	1993	2006	18-5878



18-6277
ALOJAMIENTO TILT/TRIM
Reemplaza: 435548
Heavy Duty, 2 cable conexión, Eje plano
(Aro incluido)
Para: OMC V6(1993), Comercial V8 (1993-sup)



18-6823
CABLEADO
Reemplaza: Universal
Convierte 3-cables Tilt y Trim motores a 2-cables



18-6280
ALOJAMIENTO TILT/TRIM
Reemplaza: 437801
Heavy Duty, OMC J Suffijo 40,48,50HP(1992-sup)con 2 cables conexión
(Aro incluido)



18-6281
MOTOR TILT/TRIM
Reemplaza: 438786, 439937, 5005254
(Aro incluido)
Plástico alojamiento Heavy Duty para OMC fuerabordas 75HP-250HP EFI(1998-sup)



18-6285
ALOJAMIENTO TILT/TRIM
Reemplaza: 433226
(Aro incluido)
Heavy Duty OMC (1989-92) M Suffijo 40,48,50HP con 2 cables de conexión y eje hex



18-6756
MOTOR TILT/TRIM
Reemplaza: 172588, 173944
Para: (1982-98) 2 cilindros 2 los motores que han sido encajados con el kit de inclinación 173946.



18-6759
MOTOR TILT/TRIM
Reemplaza: 394176, 391264, 393988, 985237
Diseño nuevo de 2 cables para mayoría de aplicaciones 3,4,6 y 8 cil. Desde 1982 hasta hoy.
(SÓLO MOTOR)
Use 18-7510 Aro (Aro incluido)
Reemplaza: 321163



18-6761
MOTOR TILT/TRIM
Reemplaza: 387277, 582048, 582155, 584107
(Aro incluido)
Diseño de 3 cables para mayoría 3, 4, 6 cilindros fuerabordas a partir de 1981
(Sólo Motor)



18-6762
MOTOR TILT/TRIM
Reemplaza: 172543
Para mayoría 85, 115 & 135 hp aplicaciones v-4 (Motor y depósito)



18-6767-1
MOTOR TILT/TRIM
Reemplaza: 172850, 173564, 173596
Para: 1974 (115 & 135 HP)
Para mayoría de modelos comerciales 45 hp 1989-90,
2 cilindros aplicaciones (1984-88),
3 cilindros aplicaciones (1977-83) y
4 cilindros aplicaciones (1974-77)
(Motor y depósitos)
Para kit reparación 18-6252



18-6780
MOTOR TILT/TRIM
Reemplaza: 438529, 438531, 434496
Para: 90, 115, 200, 225 HP (1991-sup);
120, 140 HP (1991-94); 130 HP (1995-sup)



18-6815
MOTOR TRIM
Reemplaza: Johnson/Evinrude
Para: 2004-09 40-50HP 2006-09 60HP,
2009 25-30HP Evinrude



18-6865
TRIM COMPLETO
Reemplaza: OMC Universal
Para: Motores con 3-ataques Trim Assembly, 115-225HP Johnson/Evinrude motores



18-6252
KIT REPARACIÓN MOTOR TILT & TRIM
Para usar con 18-6767-1
* Incluye escobillas



POWER TRIM

Ref NO.	OE NO.	APLICACIÓN
18-6801	5005114	115-130HP, V4 (2000-09)
18-6802	5005113	135-200HP, V6, 60° (2000-09)
18-6803	5005115/5007662	200-250HP, V6, 90° (2000-09)



**18-5705
POWER TRIM RELÉ**
Reemplaza:
582472, 584416, 586224
5 Terminal • Tirador
Tiro doble • 12 Volt

Contacto	Resistive	Conductive
Abierto	40 Amps	30 Amps
Cerrado	20 Amps	15 Amps



① 18-5801D

Display Package

**18-5801
SOLENOIDE**
Reemplaza: 985064, 586842, 586730

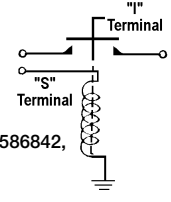

⑥ 18-5823D

Display Package

**18-5823
SOLENOIDE**

Reemplaza: 584580
Para: 9.9 4-tiempos(1995-01), 9.9 (1993 & sup),
15 4-tiempos(1995-01), 15 (1993 & sup),
8 (1996-98),

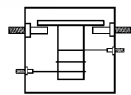

⑥ 18-5833D

Display Package

**18-5833
SOLENOIDE**

Reemplaza: 586774
Para: E40 (2004-07), E50 (2004-06), E60 (2006-07), E75 (2004-07), E90 (2004-07),
E115 (2007), E150 (2007), E175 (2007), E200 (2005-07), E225 (2005-07), E250 (2005-07)

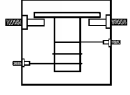

**18-5807
SOLENOIDE**
Reemplaza: 378444,
Prestolite SAW4206

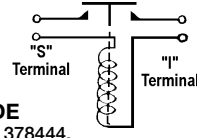

⑥ 18-5808D

Display Package

**18-5808
SOLENOIDE**
Reemplaza: 395419, 582708

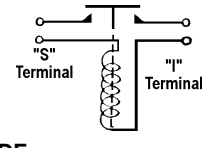

**18-5813
SOLENOIDE**
Reemplaza: 584128

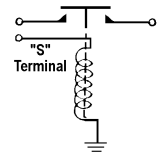

⑥ 18-5814D

Display Package

**18-5814
SOLENOIDE**
Reemplaza: 581528, 172869

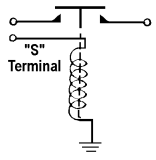

CABLES BATERÍA
Cable con terminales para roscas 3/8".

Ref No.	talla	Color	Calibre	Ref No.	talla	Color	Calibre
BC88523	2'	rojo	4	BC88563	6'	rojo	2
BC88533	2'	negro	4	BC88573	6'	negro	2
BC88543	4'	rojo	2	BC88583	8'	rojo	1
BC88553	4'	negro	2	BC88593	8'	negro	1

JOHNSON/EVINRUDE APLICACIÓN ARRANQUE SOLENOIDE

HP	Año inicial	Año final	Arranque Solenoide	HP	Año inicial	Año final	Arranque Solenoide
9.9	1990	1992	18-5813	33	1968	1970	18-5808
15	1990	1992	18-5813	35	1957	1959	18-5807
18	1957	1959	18-5807	35	1976	1988	18-5808
20	1985	1998	18-5808	35	1991	2001	18-5808
25	1972	2005	18-5808	40	1960	1966	18-5807
25	2009	2009	18-5833	40	1967	1976	18-5808
28	1986	1996	18-5808	40	1984	2005	18-5808
30	1984	2005	18-5808	40	2004	2009	18-5833
30	2009	2009	18-5833	45	1989	1992	18-5808
33	1965	1967	18-5807	48	1987	1996	18-5808

① Sin cambio eléctrico ② Con cambio eléctrico
APLICACIONES CONTINUAN EN LA SIGUIENTE PÁGINA

JOHNSON/EVINRUDE APLICACIONES ARRANQUE SOLENOIDE(CONT.)

HP	Año inicial	Año final	Arranque Solenoide	HP	Año inicial	Año final	Arranque Solenoide
50	1958	1959	18-5807	100	1984	2001	18-5808
50	1971	1975	18-5808	105	1998	2003	18-5808
50	1979	2005	18-5808	110	1986	1989	18-5808
50	2004	2009	18-5833	112	1994	1996	18-5808
55	1968	1969	18-5808	115	1969	1970	18-5808
55	1976	1981	18-5808	115	1973	1985	18-5808
55	1989	1992	18-5808	115	1990	2006	18-5808
55	1996	1997	18-5808	115	2007	2009	18-5833
55	2008	2009	18-5833	120	1985	1994	18-5808
60	1964	1966	18-5807	125	1971	1972	18-5808
60	1967	1971	18-5808	125	1989	1990	18-5808
60	1980	2001	18-5808	125	1992	1998	18-5808
60	2006	2009	18-5833	130	1995	2000	18-5808
65	1968	1968	18-5808	130	2009	2009	18-5833
65	1972	1973	18-5808	135	1973	1976	18-5808
65	1984	2001	18-5808	135	2001	2001	18-5808
65	2008	2009	18-5833	140	1977	1994	18-5808
70	1970	2001	18-5808	150	1978	2006	18-5808
75	1960	1964	18-5807	150	2007	2009	18-5833
75	1965	1965	18-5807 ❶	155	1984	1992	18-5808
75	1965	1965	18-5808 ❷	175	1977	2006	18-5808
75	1975	1988	18-5808	175	2007	2009	18-5833
75	2004	2009	18-5833	185	1984	1985	18-5808
80	1966	1966	18-5807 ❶	185	1989	1994	18-5808
80	1966	1967	18-5808 ❷	200	1976	2001	18-5808
85	1968	1980	18-5808	200	2005	2009	18-5833
85	1991	1995	18-5808	225	1986	2001	18-5808
88	1987	1996	18-5808	225	2005	2009	18-5833
90	1964	1964	18-5807	235	1978	1985	18-5808
90	1965	1965	18-5808	250	1991	2001	18-5808
90	1981	2006	18-5808	250	2005	2009	18-5833
90	2004	2009	18-5833	275	1985	1988	18-5808
100	1966	1968	18-5808	300	1985	1995	18-5808
100	1971	1972	18-5808	300	2008	2009	18-5833
100	1979	1980	18-5808				

❶ Sin cambio eléctrico ❷ con cambio eléctrico

JOHNSON/EVINRUDE APLICACIÓN TRIM RELÉ/SOLENOIDE

HP	Año inicial	Año final	Trim Relé / Solenoide	HP	Año inicial	Año final	Trim Relé / Solenoide
60	1986	2001	18-5705	125	1989	1998	18-5705
65	1991	1995	18-5705	135	1976	1976	18-5814
70	1980	1981	18-5814	140	1977	1981	18-5814
70	1981	2001	18-5705	140	1981	1994	18-5705
75	1980	1981	18-5814	150	1978	1981	18-5814
75	1982	1987	18-5705	150	1981	2006	18-5705
75	2000	2003	18-5705	175	1977	1981	18-5814
85	1976	1980	18-5814	175	1981	2006	18-5705
85	1991	1995	18-5705	185	1984	1985	18-5705
88	1986	1996	18-5705	185	1990	1994	18-5705
90	1981	1981	18-5814	200	1976	1981	18-5814
90	1981	2006	18-5705	200	1981	1983	18-5705
100	1979	1980	18-5814	200	1986	2005	18-5705
100	1984	2005	18-5705	225	1986	2005	18-5705
110	1986	1989	18-5705	235	1978	1981	18-5814
115	1976	1981	18-5814	235	1981	1985	18-5705
115	1981	1985	18-5705	250	1991	2005	18-5705
115	1990	2006	18-5705	275	1985	1988	18-5705
120	1985	1994	18-5705	300	1985	1995	18-5705



18-5708
RECTIFICADOR
 Reemplaza : 582399, 583408
 6-10 AMP

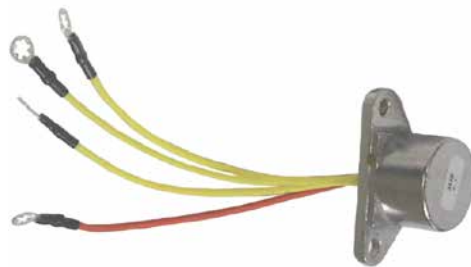

18-5709
RECTIFICADOR
 Reemplaza: 581778
 4-5 AMP



18-5825
REGULADOR/RECTIFICADOR
 Reemplaza: 395204



18-5826
REGULADOR/RECTIFICADOR
 Reemplaza: 584890



18-5827
REGULADOR/RECTIFICADOR
 Reemplaza: 585001, 584476



18-5828
REGULADOR/RECTIFICADOR
 Reemplaza: 585219, 439561



18-5829
REGULADOR/RECTIFICADOR
 Reemplaza: 586048



18-5830
REGULADOR/RECTIFICADOR
 Reemplaza: 586075

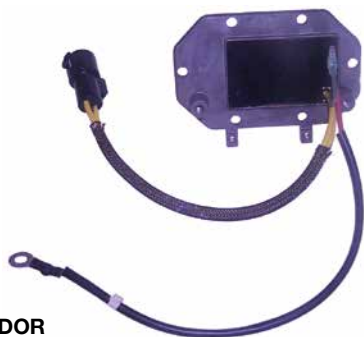

18-5831
REGULADOR/RECTIFICADOR
 Reemplaza: 586271, 584641, 585995



18-5832
REGULADOR/RECTIFICADO
 Reemplaza: 583266, 583689,
 586000, 584424

REGULADOR/RECTIFICADOR APLICACIONES EN LA SIGUIENTE PÁGINA

Modelo	Año	Ref #	Modelo	Año	Ref #
9.9,15	1974-92	18-5709	90	1981-92	18-5708
20	1989-98 ④	18-5709	90-115 60 GRADOS-V4	1996-SUP	18-5830
25	1977-03 (2 CIL) ④	18-5709	100	1971,1979-80,1984-92 ③	18-5708
25/40/50TL/ J ELEC TR	1992	18-5827	115	1973-92	18-5708
25SIK/ SIL/ SIT	1994-1995	18-5827	120/140	1985	18-5832
25/35 3 CIL.	1995-UP	18-5826	125	1971-72	18-5708
28	1989-96	18-5709	135	1974 ⑦	18-5708
30	1989-03 (2 CIL) ④	18-5709	135	1973,1975-76	18-5708
35	1976-93 (2 CIL) ④	18-5709	140	1977-88	18-5708
35JET/ TL/ J ELEC.	1992-1993	18-5827	150	1979-88	18-5708
35JET/ M-TE/ TTL	1993-1995	18-5827	150/175 60 GRADOS-V6	1991-1995	18-5828
35JET/ EL/ TL/ TTL	1996	18-5827	150/175 60 GRADOS-V6	1996-SUP	18-5829
35JET ELEC.	1997	18-5827	155	1984-88	18-5708
40	1974-76,1988-92	18-5709	175	1977-83	18-5708
40/50TE/ EL/ TL/ TTL	1993-1996	18-5827	185	1984-88	18-5708
40/ 50 ELEC. 2 CICLO.	1993-03 (2 CICLO.)	18-5827	185/200/225	1993-1994	18-5831
45	1989-92 COMM	18-5709	185/200/225/200COMM	1990-1992	18-5832
45SS	1989-90	18-5709	200	1976-83	18-5708
48	1989-92	18-5709	200/225	1986-1989	18-5832
50	1971-75	18-5708	200/225/200COMM	1994-1997	18-5831
50	1979-92	18-5709	235	1978-88	18-5708
55	1976-77	18-5708	250/300	1991-1995	18-5831
55	1978-81, 1980-92 ①	18-5709	250	1997	18-5831
60	1970 ⑤, 1971	18-5708	275	1985-1986	18-5832
60	1980-88	18-5709	275/300 (3.6L)	1987	18-5832
60	1989-91 ⑥	18-5708	275/300	1988	18-5832
SST60	1989-90	18-5708	300 (3.6L) — BABOR & EST.	1985-1986	18-5832
60	1992-01	18-5827	300	1989-1990	18-5832
65	1972-73, 1988-91	18-5708	1.8/2.0L V4 "S"	1987-1990	18-5832
65 ELEC.	1992	18-5827	2.7L V6	1986-1987	18-5832
70	1974-91 ②	18-5827	3.0L V6	1988-1990	18-5832
70	1992-01	18-5708	3.0L V6	1993-1998	18-5832
75	1975-88	18-5708	3.6L V8	1987	18-5832
85	1970-80	18-5708	4.0L V8	1989-1990	18-5832
88	1989-92	18-5708	V-4 & V-6 Crossflow con 35 AMP	TODOS	18-5825

① También modelos comerciales

② Sólo modelos 1991 EL & TL

③ Excepto modelos 1992 WTLNE & WTXENE

④ Solo encendido eléctrico

⑤ Sólo modelos D

⑥ Sólo modelos EL & TL

⑦ Sólo modelos 135443, 135483



18-6434

ARRANQUE FUERABORDAS

Reemplaza: 386430, 763454

Para: 9.9,15 HP (1974-92), 8 HP 4 tiempos (1996-98)



18-5640

ARRANQUES FUERABORDAS

Reemplaza: 395207, 387094, 585062, 586288, 778992

Para: 150-235 HP, V6 modelos

**TODOS LOS ARRANQUES SON EN SENTIDO CONTRARIO A LAS AGUJAS DEL RELOJ
APLICACIONES ARRANQUE COMIENZAN EN LA PÁGINA 263**



18-5612
ARRANQUE FUERABORDA
 Reemplaza: 432925, 586287, 586286
 Para: 175 HP modelos (1992)



18-5617
ARRANQUE FUERABORDA
 Reemplaza: 586274, 778995
 Para: 9.9, 15 HP modelos



18-5619
ARRANQUE FUERABORDA
 Reemplaza: 584799, 396235, 391511, 397023,
 586731, 586890
 Para: V6/V8 Looper modelos



18-5624
ARRANQUE FUERABORDA
 Reemplaza: 583482, 585056, 586279
 Para: 20-35 HP models (1989 & sup)



18-5627
ARRANQUE FUERABORDA
 Reemplaza: 583473, 585059, 585459, 778991
 Para: 20-35 HP modelos (1987-93)



18-5628
ARRANQUE FUERABORDA
 Reemplaza: 393570, 585060, 586285, 778994
 Para: 140 HP modelos (1993)

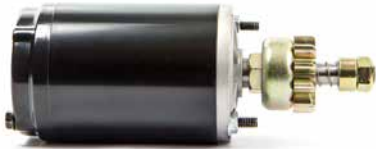

18-5629
ARRANQUE FUERABORDA
 Reemplaza: 392133, 585061, 386591, 586278
 Para: 18-40 HP modelos



18-5630
ARRANQUE FUERABORDA
 Reemplaza: 387684, 585063, 389275, 384163,
 586280, 778993
 Para: 50-60 HP, 2 cil. modelos



18-5631
ARRANQUE FUERABORDA
 Reemplaza: 584818, 586277, 778996
 Para: V-4, 60° modelos (1997 & sup)



18-5632
ARRANQUE FUERABORDA
 Reemplaza: 584980, 586284
 Para: V-4, 60° modelos (1997 & sup)



18-5634
ARRANQUE FUERABORDA
 Reemplaza: 585057, 585051, 385529, 389954,
 586283
 Para: 140 HP modelos (1977)



18-5648
ARRANQUE FUERABORDA
 Reemplaza: 585058, 586281, 386657, 391735,
 585050, 384777
 Para: 70 HP modelos

**TODOS LOS ARRANQUES SON EN SENTIDO CONTRARIO A LAS AGUJAS DEL RELOJ
 APLICACIONES ARRANQUES COMIENZAN EN LA SIGUIENTE PÁGINA**



18-6826
ARRANQUE
Reemplaza: 586768, 587045
Para: 40-90HP E-Tec



18-6863
ARRANQUE
Reemplaza: 584608, 586275
Para: Johnson/Evinrude 9.9-15HP 4-tiempos



18-6945
ARRANQUE
Reemplaza: 5036972
Para: Johnson, Suzuki 25HP 2006-11



18-6250
ARRANQUE FUERABORDA
KIT REPARACIÓN
Prestolite
2 Escobillas



18-6251
ARRANQUE FUERABORDA
KIT REPARACIÓN
Prestolite
4 Escobillas



18-5655
CONJUNTO PIÑONES
Reemplaza: 321648
Vea la siguiente página para aplicaciones adicionales



18-5671
CONJUNTO PIÑONES
Reemplaza: 384781
Vea la siguiente página para aplicaciones adicionales



18-5674
CONJUNTO PIÑONES
Reemplaza: 387683
Vea la siguiente página para aplicaciones adicionales



18-5678
CONJUNTO PIÑONES
Reemplaza: 585269, 586101
Vea la siguiente página para aplicaciones adicionales



18-5679
CONJUNTO PIÑONES
Reemplaza: 585267, 586100
Vea la siguiente página para aplicaciones adicionales



18-5697
KIT ESCOBILLAS Y MUELLES
Reemplaza: 385952
Vea la siguiente página para aplicaciones adicionales

HP	AÑOS	Arranque #	O.E. Ref #	O.E. #	Ens.Transmión ②	O.E. #	Nº de dientes	kit escobillas ②	O.E. #
9.9/ 15	1974-92	—	386430	395264	—	319977	10	ND	ND
9.9/ 15	1993 & SUP	18-5617	586274	395264	—	319977	10	ND	ND
9.9/ 15	1997 & sup 4 tiempos	—	584613	NSS	18-5679 ①	585267	10	18-5697	385952
20 ⑦	1985-88	18-5629	586278	393354	18-5655	321648	11	18-5697	385952
20 hasta 30 ⑦	1993-98	18-5629	586278	393354	18-5655	321648	11	18-5697	385952
25 hasta 35 ⑦	1977-88	18-5629	586278	NSS	18-5655	321648	11	18-5697	385952
20 hasta 30 ⑥	1989-92	18-5627	585059	393354	18-5671 ①	384781	9	18-5697	385952
25 hasta 35	1997-99 3 cilindros	18-5631	586277	586100	NSS ①	NSS	10	18-5697	385952
40-50	1984-88	18-5630	586280	NSS	18-5671 ①	384781	9	18-5697	385952
50	1972	18-5630	586280	NSS	18-5671 ①	585269	9	18-5697	385952
40-50 ①	1989-99	18-5624	586279	NSS	18-5678 ①	585269	9	18-5697	385952
55	1978	18-5630	586280	NSS	18-5678 ①	585269	9	18-5697	385952
60	1985 2 cilindros	18-5630	586280	NSS	18-5678 ①	585269	9	18-5697	385952
50	1985-99 3 cilindros	18-5648	586281	NSS	18-5678 ①	585269	9	18-5697	385952
55	1969	18-5648	586281	NSS	18-5678 ①	585269	9	18-5697	385952
60	1971	18-5648	586281	NSS	18-5671*	384781	9	18-5697	385952
60	1986-01 3 cilindros	18-5648	586281	NSS	18-5678 ①	585269	9	18-5697	385952
65	1985-01 3 cilindros	18-5648	586281	NSS	18-5678 ①	585269	9	18-5697	385952
70, 75	1980-01	18-5648	586281	NSS	18-5678 ①	585269	9	18-5697	385952
85 hasta 115	1973-99 crossflows	18-5634	586283	NSS	18-5679 ①	586100	10	18-5697	385952

**TODOS LOS ARRANQUES CON ROTACIÓN HACIA LA IZQUIERDA
APLICACIONES ARRANQUES CONTINUAN EN LA SIGUIENTE PÁGINA**

HP	AÑOS	Arranque #	O.E. Ref #	O.E. #	Ens.Transmión ②	O.E. #	Nº de dientes	kit escobillas ②	O.E. #
90, 115	1995-99 looper	18-5632	586284	ND	ND	ND	ND	18-5697	385952
120 hasta 140	1985-94	18-5628	586285	NSS	18-5679 ①	586100	10	18-5697	385952
130	1995-99	18-5628	586285	NSS	18-5679 ①	586100	10	18-5697	385952
V-6 Crossflow	1976-92	18-5640	586288	393285	18-5674	387683	8	18-5697	385952
150, 175 60°	1991-99 loopers	18-5612	586286	ND	ND	ND	ND	18-5697	385952
150 a 175 V-6	1997-03	18-5612	586287	NSS	NSS	ND	ND	ND	433850
200 hasta 300	1986-sup std. rotac.	18-5619	586411	397375	ND	ND	10	18-5697	385952

Nota: algunos arranques también sustituyen versiones prestolite, pero los repuestos sirven sólo para bosh. NSS No se vende por separado ⑤ Con 9 dientes en piñones
 * Eje con tuerca ① El kit de ens transm. incluye conjunto de piñones con retén de modelo clip ⑦ Para modelos bosh
 ② Los kits de transmisión, conjuntos, de piñones y escobillas son sólo para arranques bosh.

4-TIEMPOS KITS SISTEMA COMBUSTIBLES



18-7761
KIT RECUPERACIÓN CARBURADOR
 Para: Johnson/Evinrude 4-tiempos 4-6 hp. (2007)



18-7773
KIT RECUPERACIÓN CARBURADOR
 Reemplaza: 5032424
 Para: 25, 30 HP (2000-01) (2004 & sup)

KIT SISTEMA COMBUSTIBLE 2 TIEMPOS



18-7010
KIT CARBURADOR
 Reemplaza: 382050, 382051, 382054



18-7024
KIT CARBURADOR
 Reemplaza: 382053, 382052, 385356, 439075



18-7026
KIT CARBURADOR
 Reemplaza: 382057



18-7042
KIT CARBURADOR
 (sin flotador)
 Reemplaza: 392061, 398729, 396701



18-7222
KIT CARBURADOR
 (con flotador)
 Reemplaza: 392061, 398729, 396701



18-7043
KIT CARBURADOR
 Reemplaza: 382045, 382046, 382047, 382049, 383052, 383067, 398532, 439071, 398514



18-7046
KIT CARBURADOR
 Reemplaza: 390055, 392550, 398526, 435443, 434888, 439076, 433519
 Contiene 18-7038 aguja/asiento





18-7219
KIT CARBURADOR
 Reemplaza: 439073, 431897



18-7221
KIT CARBURADOR
 Reemplaza: 435442, 438996

2-TIEMPOS KITS SISTEMA COMBUSTIBLE

 <p>18-7223 KIT CARBURADOR con aguja y asiento Reemplaza: 398452, 391305, 398453, 439072, 391937</p>	 <p>18-7247 KIT CARBURADOR Reemplaza: 438996, 436852 Para: V4 & V6 (60°) 1988-2001</p>	 <p>18-7248 KIT CARBURADOR Reemplaza: 437327, 439079, 439078, 435676, 435677, 435678, 435752</p>
 <p>18-0871 VÁLVULA DE SERVICIO CON ARO TÓRICO Reemplaza: 175158 Para: Todos Johnson/Evinrude con válvula (excepto 1993 9.9 & 15hp.)</p>	 <p>18-7044 KIT SERVICIO DE VÁLVULA Para: Todos Johnson/Evinrude con válvula (excepto 1993 9.9 & 15 H.P.)</p>	 <p>18-0993 JUNTA Y TAPA Reemplaza: 437228 Para: Todos Johnson/Evinrude con válvula de cebado (excepto 1993 9.9 & 15hp.)</p>

 <p>AGUJA Y ASIENTO</p> <table border="1" style="width: 100%; border-collapse: collapse;"> <thead> <tr> <th style="width: 15%;">Ref #</th> <th style="width: 85%;">Reemplaza</th> </tr> </thead> <tbody> <tr> <td>18-7093</td> <td>396521, 678882, 378895</td> </tr> <tr> <td>18-7094</td> <td>379313, 396522</td> </tr> <tr> <td>18-7038</td> <td>396520, 379312, 387262</td> </tr> </tbody> </table>	Ref #	Reemplaza	18-7093	396521, 678882, 378895	18-7094	379313, 396522	18-7038	396520, 379312, 387262	<p>PACK. DE 10</p>  <p>18-7106 18-7106-9^① EMBALAJE DE AGUA Reemplaza: 307583</p>	 <p>18-7210 FLOTADOR Reemplaza: 382363</p>	<p>PACK. DE 5</p>  <p>18-7296 18-7296-9^① RETENEDOR AJUSTE AGUJA Reemplaza: 315232</p>
Ref #	Reemplaza										
18-7093	396521, 678882, 378895										
18-7094	379313, 396522										
18-7038	396520, 379312, 387262										

① Precio por pack

HP	AÑOS	KIT CARB. SIN FLOTADOR	KIT CARB. CON FLOTADOR	AGUJAS Y ASIENTO	FLOTADOR CARBURADOR
1.5	1970-90	18-7043	—	18-7094	—
2	1970-90	18-7043	—	18-7094	—
3	1952-67	18-7043	—	18-7038	—
3	1968	18-7043	—	18-7094	—
4	1983-89	18-7223	—	18-7094	—
4	1991-93	18-7223	—	18-7094	—
4.5	1982-84, 1987	18-7223	—	18-7094	—
5	1965-67	18-7043	—	18-7094	—
5	1968	18-7024	—	18-7093	—
5	1984-85	18-7223	—	18-7094	—
5.5	1954-67	18-7043	—	18-7094	—
6	1954-79	18-7043	—	18-7094	—
6	1968	18-7024	—	18-7093	—
6	1984-85	18-7223	—	18-7094	—
6, 8	1986-96	18-7219	—	—	—
7.5	1955-58	18-7043	—	18-7094	—
7.5	1982-83	18-7223	—	18-7094	—
8	1984-85	18-7223	—	18-7094	—
9.9	1974-88	18-7223	—	18-7094	—

① Comercial ② También Comercial ③ En producción ④ Corriente cruzada ⑤ Excepto 1995-sup 3 Cilindros Modelos

HP	AÑOS	KIT CARB. SIN FLOTADOR	KIT CARB. CON FLOTADOR	AGUJAS Y ASIENTO	FLOTADOR CARBURADOR
9.9/15	1989-96	18-7219	—	—	—
10	1954-63	18-7043	—	18-7094	—
14	1968 ③	18-7223	—	18-7094	—
15	1955-56	18-7043	—	18-7094	—
15	1974-88	18-7223	—	18-7094	—
18	1957-68	18-7043	—	18-7094	—
18	1969-73	18-7042	18-7222	18-7093	18-7210
20	1957-68	18-7043	—	18-7094	—
20	1969-90	18-7042	18-7222	18-7093	18-7210
20	1991-96	18-7219	—	18-7094	—
25	1954-55	18-7024	—	18-7093	—
SAIL DR	1978-SUP	18-7042	18-7222	18-7093	18-7210
25	1969-95 ⑤	18-7042	18-7222	18-7093	18-7210
28	1962-64	18-7010	—	18-7093	—
28	1976-95	18-7042	18-7222	18-7093	18-7210
30	1956	18-7024	—	18-7093	—
30	1976-SUP	18-7042	18-7222	18-7093	18-7210
33	1965-70	18-7010	—	18-7093	—
35	1957-59	18-7024	—	18-7093	—
35	1959	18-7010	—	18-7093	—
35	1976-95 ⑤	18-7042	18-7222	18-7093	18-7210
40	1960-63, 1971	18-7010	—	18-7093	—
40	1965-70, 1972-78	18-7024	—	18-7093	—
40	1971-90, 1979-92 ①	18-7042	18-7222	18-7093	18-7210
45	1971-97 ②	18-7042	18-7222	18-7093	18-7210
48	1992-97	18-7042	18-7222	18-7093	18-7210
50	1958-59	18-7026	—	18-7093	—
50	1971-97	18-7042	18-7222	18-7093	18-7210
55	1968-69, 1971-97 ②	18-7042	18-7222	18-7093	18-7210
60	1964-67	18-7026	—	18-7093	—
60	1970-97	18-7042	18-7222	18-7093	18-7210
65	1972-97	18-7042	18-7222	18-7093	18-7210
70	1972-97 (3 CIL)	18-7042	18-7222	18-7093	18-7210
75	1960-63	18-7026	—	18-7093	—
75	1975-88	18-7042	18-7222	18-7093	18-7210
80	1966-67	18-7026	—	18-7093	—
85	1968	18-7026	—	18-7093	—
85	1971-79	18-7046	—	18-7093	—
85	1969-70, 1991-93	18-7046	—	18-7038	—
V-4	1969-79	18-7046	—	18-7038	—
V-4	1983-84	18-7046	—	18-7038	—
88,90	1985-95	18-7046	—	18-7038	—
90	1981-82, 1983 ③	18-7046	—	18-7038	—
90	1995-02	18-7247	—	—	—
100	1971, 1980	18-7046	—	18-7038	—
100	1972, 1979	18-7046	—	18-7093	—
100	1998-01	18-7247	—	—	—
105	1999-01	18-7247	—	—	—
115	1969, 1980-95	18-7046	—	18-7038	—
115	1995-02	18-7046	—	18-7093	—
115	1995-02	18-7247	—	—	—
V-6	1976-90 ④	18-7046	—	18-7038	—
115	1983	18-7046	—	18-7038	—
120	1985-90	18-7248	—	18-7094	—
120	1985-90, 1993	18-7248	—	18-7094	—

HP	AÑOS	KIT CARB. SIN FLOTADOR	KIT CARB. CON FLOTADOR	AGUJAS Y ASIENTO	FLOTADOR CARBURADOR
125	1971-72	18-7046	—	18-7093	—
125	1993	18-7248	—	18-7094	—
125C	1989-95	18-7248	—	18-7094	—
135	1973-76	18-7046	—	18-7093	—
140	1977, 1980-83	18-7046	—	18-7038	—
140	1978-79	18-7046	—	18-7093	—
140	1985-90	18-7248	—	18-7094	—
140	1993	18-7248	—	18-7094	—
150	1979-90	18-7046	—	18-7038	—
150	1992-96, 1998-02	18-7247	—	—	—
155	1984-93 ①	18-7046	—	18-7038	—
175	1977-91	18-7046	—	18-7038	—
175	1992-96, 1998-02	18-7247	—	—	—
185	1984	18-7046	—	18-7038	—
185	1989-93	18-7221	—	18-7094	—
200	1976-83	18-7046	—	18-7038	—
200	1986-90	18-7248	—	18-7094	—
200	1992-93	18-7221	—	18-7094	—
225	1986-90, 1992-93	18-7221	—	18-7094	—
235	1978-84	18-7046	—	18-7038	—
250	1991-93	18-7221	—	18-7094	—
275/3.6L	1985-88	18-7221	—	18-7094	—
300	1988, 1991-93	18-7221	—	18-7094	—

① Comercial ② También Comercial ③ En producción ④ Corriente cruzada ⑤ Excepto 1995-Sup 3 Cilindro Modelos

 <p>18-7350 BOMBA COMBUSTIBLE Reemplaza: 397839, 391638, 395091, 397274 Para: 6/8/9.9/15 HP 1981-92 Use kit 18-7823</p>	 <p>18-7351 BOMBA COMBUSTIBLE Reemplaza: 434728, 438562 Para: 9.9/15 HP 1993-2006 Use kit 18-7800</p>	 <p>18-7352 BOMBA COMBUSTIBLE Reemplaza: 438556, 388268, 385781, 394543, 382354, 395713, 398338, 432451, 398387, 433387 Para: 25-55 HP 1976-89 (no-VRO) Use kit 18-7821</p>
 <p>18-7353 BOMBA COMBUSTIBLE Reemplaza: 438555, 433386 Para: 20-30 HP 1990-2000 Use kit 18-7800</p>	 <p>18-7800 KIT BOMBA COMBUSTIBLE Reemplaza: 438616, 433519</p>	 <p>18-7801 KIT BOMBA COMBUSTIBLE Reemplaza: 379777</p>
 <p>18-7820 KIT BOMBA COMBUSTIBLE Reemplaza: 393103</p>	 <p>18-7821 KIT BOMBA COMBUSTIBLE Reemplaza: 398514, 395867</p>	 <p>18-7822 KIT BOMBA COMBUSTIBLE Reemplaza: 432962</p>



18-7823
KIT BOMBA COMBUSTIBLE
Reemplaza: 393088

PACK. DE 2



18-7796
18-7796-9④
VÁLVULA DE COMPROBACIÓN
Reemplaza: 335334
(Ampliada para mostrar detalle)



18-3497
KIT DIAFRAGMA
Reemplaza: 5033372
4-5 HP (2003-06), 6 HP (2005-06)
4-tiempo



18-3498
KIT DIAFRAGMA
Reemplaza: 5036216, 5037584
10-15 HP (2005-07)
4-tiempos



18-3499
KIT DIAFRAGMA
Reemplaza: 5030699
9.9,15 HP (2002-04), 25HP (2004-06),
30HP (2004-07), 40-70 HP (2002-06)
4-tiempos

APLICACIÓN KIT REPARACIÓN BOMBA COMBUSTIBLE

Todos los kits son para no-VRO (TASA VARIABLE) bombas de lubricación

HP	Año inicial	Año final	kit rep. bomb. comb.	HP	Año inicial	Año final	kit rep. bomb. comb.	HP	Año inicial	Año final	kit rep. bomb. comb.
2.5	1987	1988	18-7823	25	2001	2001	18-3497④	50	1990	2012	18-7800
3	1989	1997	18-7823	25	2004	2005	18-3497④	50	AA	AG	18-7800
4	1982	2001	18-7823	28	1962	1963	18-7801	50	1999	2006	18-3497④
4	2003	2007	18-3497④	28	1986	1987	18-7821	55	1983	1984	18-7820
4.5	1982	1987	18-7823	28	1988	1990	18-7822	55	1985	1990	18-7821
5	1982	1983	18-7823	28	1990	1998	18-7800	55	1991	2005	18-7800
5	1985	1993	18-7823	30	1984	1984	18-7820	55	2008	2012	18-7800
5	1996	1998	18-7823	30	1985	1987	18-7821	55	AA	AG	18-7800
5	2003	2007	18-3497④	30	1988	1990	18-7822①	60	1964	1967	18-7801
6	1984	2005	18-7823	30	1990	2005	18-7800②	60	1982	1984	18-7820
6	1987	1987	18-7821	30	2001	2001	18-3497④	60	1985	1985	18-7821
6	2003	2007	18-3497④	30	2004	2007	18-3497④	60	1988	1988	18-7821
7.5	1980	1983	18-7823	35	1958	1959	18-7801	60	2002	2006	18-3497④
8	1982	2005	18-7823	35	1976	1984	18-7820	60	2005	2012	18-7800
8	1987	1987	18-7821	35	1986	1987	18-7821	60	AA	AG	18-7800
9.9	1974	1992	18-7823	35	1988	1990	18-7822	65	1984	1984	18-7820
9.9	1987	1990	18-7821②	35	1990	2001	18-7800	65	1985	1985	18-7800④
9.9	1990	1999	18-7800	40	1960	1964	18-7801	65	1985	1986	18-7821
10	1996	2007	18-7800	40	1971	1976	18-7820	65	1989	1989	18-7821
10	2002	2004	18-3497④	40	1983	1984	18-7820	65	1991	2001	18-7800
10	2005	2007	18-3497④	40	1985	1987	18-7821	65	2008	2012	18-7800
14	1988	1989	18-7823	40	1988	1990	18-7822①	65	AA	AF	18-7800
15	1974	1998	18-7823	40	1990	2012	18-7800②	70	1982	1984	18-7820
15	1987	1990	18-7821②	40	AA	AG	18-7800	70	1998	2006	18-3497④
15	1990	2007	18-7800	40	1999	2006	18-3497④	75	1960	1965	18-7801
15	2002	2004	18-3497④	45	1958	1959	18-7801	75	1982	1984	18-7820
15	2005	2007	18-3497④	45	1986	1990	18-7821	75	2004	2012	18-7800
20	1985	1987	18-7821	45	1991	1997	18-7800	75	AA	AF	18-7800
20	1988	1990	18-7822①	48	1987	1987	18-7821	80	1966	1967	18-7801
20	1990	1998	18-7800②	48	1988	1990	18-7822①	85	1977	1983	18-7820
25	1971	1976	18-7823	48	1990	1996	18-7800②	88	1987	1990	18-7821①
25	1977	1984	18-7820	50	1958	1959	18-7801	88	1990	1996	18-7800②
25	1985	1987	18-7821	50	1982	1984	18-7820	90	1964	1965	18-7801
25	1988	1990	18-7822①	50	1985	1987	18-7821	90	1981	1983	18-7820
25	1990	2005	18-7800②	50	1988	1990	18-7822	90	1997	1998	18-7800

④ Precio por pack

APLICACIONES CONTINUAN EN LA SIGUIENTE PÁGINA

APLICACIÓN KIT REPARACIÓN BOMBA COMBUSTIBLE

Todos los kits son para no-VRO (TASA VARIABLE) bombas de lubricación

HP	Año inicial	Año final	kit rep. bomb. comb.	HP	Año inicial	Año final	kit rep. bomb. comb.	HP	Año inicial	Año final	kit rep. bomb. comb.
90	2004	2012	18-7800	112	1994	1996	18-7800	150	1978	1984	18-7820
90	AA	AF	18-7800	115	1982	1983	18-7820	175	1977	1983	18-7820
100	1966	1966	18-7801	115	1997	1998	18-7800	200	1977	1983	18-7820
100	1989	1990	18-7821	115	2004	2005	18-7800	235	1978	1984	18-7820
100	1996	1997	18-7800	125	1995	1998	18-7800				
105	1997	2003	18-7800	140	1977	1983	18-7820				

④ Precio por pack

APLICACIONES CONTINUAN EN LA PRÓXIMA PÁGINA

APLICACIÓN BOMBA COMBUSTIBLE

HP	Año inicial	Año final	Bomba combustible	HP	Año inicial	Año final	Bomba combustible
6	1988	1991	18-7350	35	1990	1994	18-7353
8	1988	1991	18-7350	35	1996	1996	18-7353
9.9	1981	1992	18-7350	40	1968	1976	18-7352
9.9	1993	1999	18-7351	40	1983	1984	18-7352
10	1997	1998	18-7351	50	1974	1975	18-7352
10	2000	2001	18-7351	50	1979	1984	18-7352
10	2003	2007	18-7351	55	1976	1981	18-7352
15	1981	1998	18-7350	55	1983	1984	18-7352
15	1993	2007	18-7351	60	1980	1984	18-7352
20	1990	1998	18-7353	85	1977	1980	18-7352
25	1977	1984	18-7352	90	1981	1983	18-7352
25	1990	2005	18-7353	90	1997	1998	18-7352
28	1990	1996	18-7353	100	1979	1980	18-7352
30	1984	1984	18-7352	100	1997	1997	18-7352
30	1990	2005	18-7353	115	1977	1983	18-7352
33	1968	1970	18-7352	115	1997	1998	18-7352
35	1976	1984	18-7352	140	1977	1983	18-7352

KITS SEPARADORES AGUA COMBUSTIBLE

KIT FILTROS DE 21 MICRON PARA MOTORES CARBURACIÓN



TIPO KIT	REF #	CAPACIDAD DE FILTRADO	CONTIENE
1/4" Aluminio (Filtro corto)	18-7848-1	21	1 - 18-7844 filtro & 1 18-7853-1 soporte 2 - 18-4256 1/4" TAPONES
1/4" ALUMINIO BONUS PACK FILTRO DE REPUESTO	18-7848-2	21	2 - 18-7844 FILTRO & 1 18-7853-1 SOPORTE 2 - 18-4256 1/4" TAPONES
1/4" ALUMINIO (FILTRO ALTO) FILTRO DE REPUESTO	18-7852-1	21	1 - 18-7845 FILTRO & 1 18-7853-1 SOPORTE 2 - 18-4256 1/4" TAPONES
3/8" ALUMINIO (FILTRO ALTO)	18-7775-1	21	1 - 18-7845 FILTRO & 1 18-7775 SOPORTE 2 - 18-4264 3/8" TAPONES
1/4" ACERO INOXIDABLE (FILTRO ALTO)	18-7777-1	21	1 - 18-7845 FILTRO & 1 18-7777 SOPORTE 2 - 18-4256 1/4" TAPONES
3/8" ACERO INOXIDABLE (FILTER ALTO)	18-7776-1	21	1 - 18-7845 FILTRO & 1 18-7776 SOPORTE 2 - 18-4264 3/8" TAPONES

**- DISEÑO UNIVERSAL-
RECAMBIO DIRECTO PARA MERCURY Y YAMAHA
SOPORTE SEPARADOR DE COMBUSTIBLE/AGUA**



Soporte tipo	Ref #
1/4" acero inox	18-7777
3/8" acero inox	18-7776



Soporte tipo	Ref #
1/4" Aluminio	18-7853-1
3/8" Aluminio	18-7775



**KITS DE FILTRO DE 10 MICRONES
PARA MOTORES
DE INYECCIÓN DE COMBUSTIBLE**



TIPO KIT	Ref #	Micrones	Contenido
1/4" Aluminio (filtro corto)	18-7983-1	10	1 - 18-7944 filtro & 1 18-7853-1 soporte 2 - 18-4256 1/4" tapones
1/4" pack aluminio contiene filtro recambio	18-7983-2	10	2 - 18-7944 filtro & 1 18-7853-1 soporte 2 - 18-4256 1/4" tapones
1/4" Aluminio (filtro largo)	18-7982-1	10	1 - 18-7945 filtro & 1 18-7853-1 soporte 2 - 18-4256 1/4" tapones
1/4" Pack aluminio Contiene filtro recambio	18-7982-2	10	2 - 18-7945 filtro & 1 18-7853-1 soporte 2 - 18-4256 1/4" tapones
1/4" Aluminio (Filtro alta capacidad)	18-7966-1	10	1 - 18-7866 filtro & 1 18-7853-1 soporte 2 - 18-4256 1/4" tapones
3/8" Aluminio (filtro largo)	18-7986-1	10	1 - 18-7945 filtro & 1 18-7775 soporte 2 - 18-4264 3/8" tapones
1/4" Acero inox (filtro largo)	18-7984-1	10	1 - 18-7945 filtro & 1 18-7777 soporte 2 - 18-4256 1/4" tapones
3/8" Acero (filtro largo)	18-7985-1	10	1 - 18-7945 filtro & 1 18-7776 soporte 2 - 18-4264 3/8" tapones



KITS FILTROS DE 10 MICRAS CON CAZOLETA DE DRENAJE

Sierra AquaVue™ permiten el drenaje y alargan la vida útil del filtro. Use the AquaVue™ para fueraborda, instalaciones sobre cubierta. USCG requiere el uso de la cazoleta metálica debajo de la cubierta.

Tipo kit	Ref #	Micrones	Contenido
1/4" Aluminio con cazoleta AquaVue™	18-7932-1	10	1 - 18-7919 filtro & 1 18-7853-1 soporte 1 - 18-7922-1 AquaVue™ cazoleta 2 - 18-4256 1/4" tapones
1/4" Aluminio cazoleta metálica	18-7951	10	1 - 18-7919 filtro & 1 18-7853-1 soporte 1 - 18-7924 cazoleta metálica 2 - 18-4256 1/4" tapones
1/4" Acero inox con cazoleta AquaVue™	18-7937-1	10	1 - 18-7919 filtro & 1 18-7777 soporte 1 - 18-7922-1 AquaVue™ cazoleta 2 - 18-4256 1/4" tapones
1/4" Acero inox con cazoleta metálica metal	18-7938	10	1 - 18-7919 filtro & 1 18-7777 soporte 1 - 18-7924 cazoleta metálica 2 - 18-4256 1/4" tapones

SOPORTE Y KIT - PARA APLICACIONES EN PEQUEÑOS FUERABORDAS Y AGUA DULCE

**18-7774
SOPORTE DE ALUMINIO COMPACTO**



**18-7965-1
KIT SEPARADOR
COMPACTO 10 MICRAS**
Contiene:
1 - 18-7774 soporte
1 - 18-7865 filtro



FILTROS DE RECAMBIO



DISEÑO UNIVERSAL

FILTROS RECAMBIO 10 MICRAS		FILTROS RECAMBIO 21 MICRAS	
Ref No.	Descripción	Ref No.	Descripción
18-7944	Corto - 3.875"	18-7844	corto - 3.875"
18-7945	Largo - 4.35"	18-7845	Largo - 4.35"
18-7866	Gran capacidad - 6"		
18-7865	Compacto 10 Micras		

FILTRO DE RECAMBIO PARA OMC

FILTROS RECAMBIO 10 MICRAS			RECAMBIO FILTROS 21 MICRAS		
Ref No.	Descripción	Reemplaza	Part No.	Descripción	Reemplaza
18-7946	OMC rosca	OMC 502905	18-7846	OMC rosca	OMC 502905
18-7989	Cobra EFI	OMC 502906	18-7789	Cobra EFI	OMC 502906



FILTROS DE RECAMBIO DE 10 MICRAS Y KITS CON CAZOLETAS

FILTRO RECAMBIO			KITS FILTROS Y CAZOLETAS	
Ref No.	Descripción	Reemplaza	Ref No.	Descripción
18-7919	Recambio	Racor S3213	18-7928-1	Filtro & cazoleta AquaVue™ Contiene: 18-7919 filtro, cazoleta 18-7922-1
18-7920	Recambio	OMC 502906 Racor S3214	18-7929	Filtro & cazoleta metálica Contiene: 18-7919 filtro, cazoleta 18-7924
CAZOLETA RECAMBIO <th>Ref No.</th> <th>Descripción</th>			Ref No.	Descripción
			18-7922-1	Cazoleta AquaVue™
18-7924	Cazoleta metálica		18-7941-1	Filtro & cazoleta AquaVue™ contiene: 18-7920 filtro, cazoleta 18-7922-1
			18-7943	Filtro & Cazoleta metálica Contiene: 18-7920 filtro, cazoleta 18-7924



**18-79781
FILTRO COMB.**
Reemplaza: 433190
60° V4 y V6



**18-7953
FILTRO COMB.**
Reemplaza: 5035974
Para: 25HP (2006-07) / 90,115,140
4 tiempos (2005-06)



**18-7716
FILTRO COMB**
Reemplaza: 5032323
Para: Johnson 25 4-tiempos (2004-05),
30 4-tiempos (2004-07), 40/60/70
4-tiempos (2002-06), 90/115/140
4-tiempos (2003-04, 2006), Evinrude
25/30/40/50/70 4-tiempos (2000-01)



**18-7719
FILTRO COMB.**
Reemplaza: 5032238
Para: Johnson 4/5 (2003-07), 6
4-tiempos (2005-07), 10/15 4-tiempos
(2002-07),
40/50/60/70 4-tiempos (2002-06), Evin-
rude 40/50 4-tiempos (2000-01)



**18-7722
FILTRO COMB.**
• 3/8"
Reemplaza: 5005266
Para: E-Tec 40, 50, 60, 75, 90,115, 150, 175 & 200DPL



**18-7826
FILTRO COMB**
Reemplaza: 305185



Filtro combustible en línea

Ref No.	Aplicación
18-7828-1	1/4" pequeña capacidad (Para 1/4" línea comb)
18-7829	1/4" Gran capacidad (Para 1/4" línea comb)
18-7830	5/16" Reemplaza: OMC 398327
18-7831	3/8" Reemplaza: OMC 398319

FUERABORDA – JOHNSON/EVINRUDE (OMC/BRP) - Sistema combustible

LÍNEAS DE COMBUSTIBLE LONGITUD 8'

3/8"
LÍNEA DE COMB.

18-8009EP-1 *SILVERADO 4000 Premium*

OE# 398549



18-8063
CONECTOR
DEPÓSITO
(SE VENDE POR SEPA-
RADO)

18-8092
CONECTOR
COMBUSTIBLE

18-8005EP-1
BOMBA
MANUAL

18-8092
CONECTOR
COMBUSTIBLE

*

*

COMPONENTES DE LA LÍNEA DE COMBUSTIBLE
Para: 2 HP (1 cil.) - 75 HP (3 cil.) (1976-02)

LÍNEAS DE COMBUSTIBLE LONGITUD 8'

3/8"
LÍNEA DE COMB.

18-8014EP-1 *SILVERADO 4000 Premium*

OE# 174509



18-8074
CON. DE MANGUERA
(SE VENDE POR SEPARADO)

18-8005EP-1
BOMBA
MANUAL

18-8092
CONECTOR
COMBUSTIBLE

*

*

COMPONENTES DE LA LÍNEA DE COMBUSTIBLE
Para: Todos V6 & V8 (1976-02)



Display Package

18-8004EP-1
18-8004-10EP-1^①
BOMBA MANUAL

5/16"
Reemplaza: 174511, 775638
Bomba gran capacidad



Display Package

18-8005EP-1
18-8005-10EP-1^①
BOMBA MANUAL

3/8"
Reemplaza: 174512
Bomba gran capacidad



Display Package

**APLICACIÓN CON.
DE MANGUERA**

FILTROS COMB EN LÍNEA

Ref No.	OMC No.	Barb	NPT	Con. Tipo
18-8055	173311	5/16"	1/4"	M
18-8074	173312	3/8"	1/4"	M



Display Package

18-8056
18-8056-10^①
CONECTOR COMB

5/16"
Reemplaza: 174508, 775640
Se acopla con 18-8063



Display Package

18-8063
18-8063-10^①
CONECTOR TANQUE

Reemplaza: 502867, 772681
(1/4" NPT)
Se acopla con 18-8056 & 18-8092



Display Package

18-8072
CODO COMBUSTIBLE

3/8" conexión con 3/8"
Reemplaza: 174177
90°



Display Package

18-8092
CONECTOR COMBUSTIBLE

3/8"
Reemplaza: 176445, 775641
Se acopla con 18-8063



Display Package

18-3290
CODO INDICADOR

Reemplaza: 321886
Rosca de manguera



MANGUERA DE SANGRADO

18-8048 **18-8050**
.090 D.I. x .220 D.E. .0625 D.I. x .190 D.E.



18-8051
MANGUERA COMBUSTIBLE
DOBLE

1/8" D.I.
Reemplaza: 322656
Para Sistemas Presurizados OMC



18-8052
MANGUERA COMBUSTIBLE

3/16" D.I.
Reemplaza: 122838
No-Sistemas Presurizados

**SAE J1527 USCG Type B1-15
SILVERADO 4000**



16-337-0560
5/16" D.I.

16-337-0380
3/8" D.I.

Disponibles bobinas 50'.

* Tanques y motores sólo a modo ilustrativo.

① Pack de 10 - Precio por envase

**PURE FUEL DELIVERS PURE
PERFORMANCE**



SIERRA FILTERS

INDUSTRY LEADER IN 10-MICRON TECHNOLOGY



Increased levels of engine sophistication, coupled with ethanol fuel blends, necessitate the use of a high quality fuel filter. Sierra filters are engineered to offer the ultimate in filtration, separation of water from the fuel supply and provide maximum fuel flow.

www.seastarsolutions.com



SEASTAR
SOLUTIONS®



18-9125
KIT ABRAZADERA
 Reemplaza: 787133, 787145

Ref #	Cant	Johnson/Evinrude #	Oetiker #	Descripción	
18-9141	1	787145	14100082	kit abrazaderas	
Nominal D.E					
Ref #	Cant	Johnson/Evinrude #	Oetiker #	Pulgadas	mm
18-9126-9	10	346930	16700004	3/8"	9.5
18-9127-9	10	348838	16700006	13/32"	10.5
18-9128-9	10	349516	16700007	7/16"	11.3
18-9129-9	10	347107	16700010	1/2"	13.3
18-9130-9	10	347108	16700011	17/32"	13.8
18-9131-9	10	346931	16700012	35/64"	14
18-9132-9	10	346785	16700013	9/16"	14.5
18-9133-9	10	346786	16700016	5/8"	15.7
18-9134-9	10	348839	16700017	11/16"	17
18-9135-9	10	346151	16700024	13/16"	21
18-9136-9	10	346152	16700031	1"	25.6
18-9137-9	10	346153	16700037	1 3/16"	30.1
18-9138-9	10	349759	16700040	1 1/4"	31.6
18-9139-9	10	349729	16700053	1 5/8"	41
18-9140-9	10	346150	16700020	23/32"	18.5

Las abrazaderas vienen en envase de 10 y cada envase está disponible individualmente

Pack. de 10



ABRAZADERAS

Ref No.	Ref. O.E. No.	Gama	Talla
⓪ 18-8020	322652	.538 - .608	8
⓪ 18-8021	911616	.597 - .665	10
⓪ 18-8034	329654	.670 - .780	12
⓪ 18-8200	322653	.360 - .406	2
⓪ 18-8201	124249	.410 - .468	4
⓪ 18-8202	322654	.475 - .536	6
⓪ 18-8203*	329653	.750 - .875	14
⓪ 18-8204*	324825	.875 - .975	19



56507
LOCTITE® PST 6ML
SELLADOR
 Reemplaza: 910048
 (con Teflon®)



18-3001
IMPULSOR
 Reemplaza: 277181, 434424



18-3002
IMPULSOR
 Reemplaza: 375638, 775518



18-3003
IMPULSOR
 Reemplaza: 377178, 775519



18-3006
IMPULSOR
 Reemplaza: 378891, 775521



18-3015
IMPULSOR
 Reemplaza: 396852, 433935, 797407
 Con llave
 Para: 2.5, 3, 4 Ultra, Excel



18-3043
IMPULSOR
 Reemplaza: 389642



18-3044
IMPULSOR
 Reemplaza: 385072



18-3050
18-3050-10①
IMPULSOR
 Reemplaza: 386084



18-3051
IMPULSOR
 Reemplaza: 395289

① Precio por pieza. Para pedir precio por envase añadir -9 a la referencia.

 <p>18-3053-1 IMPULSOR Reemplaza: 396725 Llave de cuña</p>	 <p>18-3055 IMPULSOR Reemplaza: 389589</p>	 <p>18-3059 18-3059-10^① IMPULSOR Reemplaza: 381538, 389289, 394534, 395864, 397131, 435821, 435748, 439948, 5001593 Incluye 18-3299 Llave impulsora</p>	 <p>18-3082 IMPULSOR Reemplaza: 382547 Llave ranura</p>
 <p>18-3083 IMPULSOR Reemplaza: 377230, 777213</p>	 <p>18-3090 IMPULSOR Reemplaza: 387361, 763735</p>	 <p>18-3091 IMPULSOR Reemplaza: 389576</p>	 <p>18-3099 IMPULSOR Reemplaza: 5033112 Para: 4 tiempos 9.9 y 15 HP (2002-sup)</p>
 <p>18-3104-1 IMPULSOR Reemplaza: 432941, 437059, 765350</p>	 <p>18-3366 IMPULSOR Reemplaza: 390286</p>	 <p>18-3368 IMPULSOR Reemplaza: 396809</p>	 <p>18-45312 IMPULSOR Reemplaza: 114812 Para: J/E 2(1993-99), 3(1991-99)</p>
 <p>18-45221 IMPULSOR Reemplaza: 382221 Para: Johnson Evinrude 1.5/2 hp (1967-84)</p>	 <p>18-3102 IMPULSOR PLATINA Reemplaza: 305303</p>	 <p>18-3103 IMPULSOR PLATINA Reemplaza: 303069</p>	 <p>18-3127 IMPULSOR PLATINA Reemplaza 319275</p>
 <p>18-3182 IMPULSOR PLATINA Reemplaza: 317841</p>	 <p>18-3346 ALOJAMIENTO Y PLATINA IMPULSOR Reemplaza: 435027</p>	 <p>18-3359 PLATINA IMPULSOR Reemplaza: 328755</p>	 <p>18-3179 CASQUILLO BOMBA AGUA Reemplaza: 324097</p>

APLICACIONES COMIENZAN EN LA PÁGINA 62

① Pack de 10- Precio por pack



18-3455
CASQUILLO BOMBA DE AGUA
Reemplaza: 340619
Para: 40, 50, 25 Jet, 30 Jet 1995-sup,
E-Tec 40/50/60 HP todos

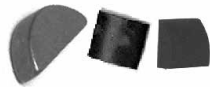

Llave impulsora

Ref No.	Reemplaza	Std. Pkg
18-3295 ③	330619, 344470	3
18-3138 ① ③	334897	2
18-3108	308928	1
18-3299 ③	331107	5
18-3326	300611	1

① Pack de 2 ② Pack de 3



18-3501
DIAFRAGMA & ENSAMBLAJE
Reemplaza: 435957
Para: 8 (1996-97), 10 (1996-97), 15 (1996-97),
40 (1995-97), 50 (1995-97), 55 (1995-97),
60 (1993-96), 65 (1993-96), 70 (1993-96),
120 (1993-94), 125 (1993-95), 130 (1995-96),
140 (1993-94), 250 (1994-95), 300 (1994-95)



18-3358
CASQUILLO BOMBA DE AGUA
Reemplaza: 328751



18-3129
BOMBA AGUA ALOJAMIENTO
Reemplaza: 435673, 438591,
436954, 432955



18-3405
BOMBA AGUA ALOJAMIENTO
Reemplaza: 435959



18-3180
BOMBA AGUA ALOJAMIENTO
Reemplaza: 435390



18-3336
BOMBA AGUA ALOJAMIENTO
Reemplaza: 384087



18-3363
BOMBA AGUA ALOJAMIENTO
Reemplaza: 330560



18-3367
BOMBA AGUA ALOJAMIENTO
Reemplaza: 393632



18-3126
PLATINA DESGASTE
Reemplaza: 321940



18-3178
PLATINA DESGASTE
Reemplaza: 318995



18-3343
PLATINA DESGASTE
Reemplaza: 320981



18-3201
KIT REPARACIÓN IMPULSOR
Reemplaza: 379763

— CONTIENE —

Ref #	Desc.	O.E. #	Cant.
18-3001	Impulsor	277181, 434424	1
NSS	Platina	203132	1



18-3202
KIT REPARACIÓN IMPULSOR

— CONTIENE —

Ref #	Desc.	O.E. #	Cant.
18-3001	Impulsor	277181, 434424	1
18-3102	Impulsor platina	305303	1



18-3203
KIT REPARACIÓN IMPULSOR
Reemplaza: 379766, 379766

— CONTIENE —

Ref #	Desc.	O.E. #	cant.
18-3002	Impulsor	375638	1
18-3103	Impulsor platina	303069	1

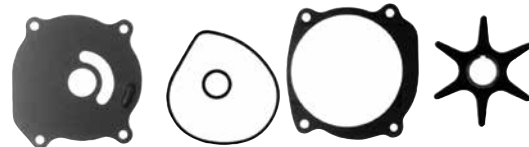

18-3210
KIT REPARACIÓN IMPULSOR

— CONTIENE —

Ref #	Desc.	O.E. #	Cant.
18-3043	Impulsor	389642	1
18-2536	Retén goma	321120	1
18-2557	Junta impulsor	324701, 338484	1
18-7158	Aro	310967, 310585	1

APLICACIONES EMPIEZAN EN LA PÁGINA 62

③ Precio por producto. Para precio por envase poner-9 en la referencia.

①18-3211D



**18-3211
KIT REPARACIÓN IMPULSOR**

— CONTIENE —

Ref #	Desc.	O.E. #	Cant.
18-3059	Impulsor	395864, 397131, 435821	1
18-2536	Retén goma	321120	1
18-2557	Junta impulsor	324701, 338484	1
18-3299	Llave impulsora	331107	1
18-7158	Aro	310967, 310585	1
18-3138	llave impulsora	334897	1



**18-3238
KIT BOMBA AGUA**
Reemplaza: 388891

— CONTIENE —

Ref #	Desc.	O.E. #	Cant.
18-3051	Impulsor	395289	1
18-0446	Junta bomba agua	323311	1
18-0445	Junta bomba agua	323312	1
18-2030	retén aceite	321786	1
18-7105	Aro	311338	2
18-3133	tornillo acero inox	331979	4



**18-3453
KIT BOMBA AGUA**

Con alojamiento
Reemplaza: 5006511
Para: E-Tec 40/50/60 HP Todos



**18-3454
KIT BOMBA AGUA**

con alojamiento
Reemplaza: 438592
Para: 40, 50, 25 Jet, 30 Jet 1995-sup
Incluye impulsor 18-3104-1



**18-3325
KIT BOMBA AGUA**
Reemplaza: 387326

— CONTIENE —

Ref #	Desc.	O.E. #	Cant.
18-7134	Aro tórico	339543	1
18-3108	Llave	308928	1
18-3337	Casquillo	315837	1
18-3083	Impulsor	377230	1
18-3343	Impulsor platina	320981	1
18-2705	Casquillo	315748	1



**18-3327
KIT BOMBA AGUA**

con alojamiento
Reemplaza: 394711, 386697, 391698, 389112, 387610

— CONTIENE —

Ref #	Desc.	O.E. #	Cant.
18-3050	Impulsor	386084	1
18-3180	Alojamiento	435390	1
18-3178	Platina desgaste	318995	1
18-3179	Casquillo bomba de agua	324097	1
18-3329	Casquillo	302497	1
18-2392	Casquillo	327035	1
18-2025	Retén aceite	318972	1
18-7116	Aro	303097	1
18-7139	aro	319085	1
18-3326	Pin	300771	1
18-3369	Tornillo acero inox	319126	4



**18-3376
KIT BOMBA AGUA**
Sin alojamiento
Reemplaza: 384956

— CONTIENE —

Ref #	Desc.	O.E. #	Cant.
18-3083	Impulsor	377230	1
18-3343	Impulsor platina	320981	1
18-3108	llave	308928	1
18-3337	Casquillo	315837	1
18-7134	Aro tórico	339543	1
18-2705	Casquillo	315748	1
18-3136	tornillo (largo)	324430	2
18-3369	Tornillo acero inox	319126	2



**18-3377
KIT BOMBA AGUA**

Sin alojamiento
Reemplaza: 382468

— CONTIENE —

Ref #	Desc.	O.E. #	Cant.
18-3002	Impulsor	375638	1
18-3103	Impulsor platina	303069	1
18-3329	Casquillo tubo de agua	302497	1
18-3326	Pin	300771	1

APLICACIONES EMPIEZAN EN LA PÁGINA 62

① referencias acabadas en "D" envasadas

**18-3378
KIT BOMBA AGUA**

con alojamiento
Reemplaza: 391635, 439077

— CONTIENE —

Ref #	Desc.	O.E. #	Cant.
18-3055	Impulsor	389589	1
18-3343	Impulsor platina	320981	1
18-3336	Alojamiento	384087	1
18-2709	Junta platina desgaste	336530	1
18-3365	Tornillo acero inox	909533	2
18-3369	Tornillo acero inox	319126	2
18-2705	Retén	315748	1
18-3337	Casquillo tubo de agua	315837	1
18-7134	Aro tórico	303059	1



**18-3379
KIT BOMBA AGUA**

Sin alojamiento
Reemplaza: 390381

— CONTIENE —

Ref #	Desc.	O.E. #	Cant.
18-3366	Impulsor	390286	1
18-3352	Impulsor platina	325398	1
18-3354	Junta bomba agua	325399	2
18-3332	Casquillo	304056	1



**18-3380
KIT BOMBA AGUA**

Sin alojamiento
Reemplaza: 390770

— CONTIENE —

Ref #	Desc.	O.E. #	Cant.
18-3055	Impulsor	389589	1
18-3343	Impulsor platina	320981	1
18-2709	Junta platina desgaste	336530	1
18-3365	Tornillo acero inox	909533	2
18-3136	Tornillo acero inox	319126	2
18-2705	Retén	315748	1
18-3337	Casquillo tubo de agua	315837	1
18-7134	Aro tórico	303059	1



**18-3381
KIT BOMBA AGUA**

Sin alojamiento
Reemplaza: 393509

— CONTIENE —

Ref #	Desc.	O.E. #	Cant.
18-3051	Impulsor	395289	1
18-3359	Impulsor platina	328755	1
18-0124	Junta impulsor platina	325537	1
18-3358	Tapa bomba agua	328751	1
18-2539	Retén goma	328753	1
18-3329	Casquillo	302497	1
18-7100	Aro tórico	301877	1
18-7105	Aro tórico	311338	2
18-7146	Aro tórico	554545	1
18-3133	Tornillo acero inox	331979	6



**18-3382
KIT BOMBA AGUA**

Con alojamiento
Reemplaza: 393630

— CONTIENE —

Ref #	Desc.	O.E. #	Cant.
18-3051	Impulsor	395289	1
18-3359	Impulsor platina	328755	1
18-3367	Alojamiento	393632	1
18-3358	Tapa bomba agua	328751	1
18-0124	Junta impulsor platina	325537	1
18-3329	Casquillo	302497	1
18-7100	Aro tórico	301877	1
18-7105	Aro tórico	311338	2
18-7146	Aro tórico	554545	1
18-3133	Tornillo acero inox	331979	6



**18-3383
KIT BOMBA AGUA**

Con alojamiento
Reemplaza: 395270

— CONTIENE —

Ref #	Desc.	O.E. #	Cant.
18-3051	Impulsor	395289	1
18-3363	Alojamiento	330560	1
18-3358	Tapa bomba agua	328751	1
18-3360	Junta impulsor alojamiento	329390	1
18-3329	Casquillo	302497	1
18-3133	Tornillo acero inox	331979	4



**18-3384
KIT BOMBA AGUA**

Sin alojamiento
Reemplaza: 386124

— CONTIENE —

Ref #	Desc.	O.E. #	Cant.
18-7158	Aro	310585	1
18-3108	Llave	308928	1
18-3043	Impulsor	389642	1
18-3182	Impulsor platina	317841	1
18-2026	Retén aceite	321453	1
18-3135	Tornillo	306643	2
18-3136	Tornillo	323626	4
18-2389	Casquillo	314832	2





18-3385
KIT BOMBA AGUA
Sin alojamiento
Reemplaza: 396932

— CONTIENE —

Ref #	Desc.	O.E. #	Cant.
18-3368	Impulsor	396809	1
18-3343	Impulsor platina	320981	1
18-2705	Retén	315748	1
18-7481	Goma retén	324981	1
18-7134	Aro tórico	303059	1
18-3337	Casquillo tubo de agua	315837	1
18-3365	Tornillo acero inoxidable	909533	2
18-3369	Tornillo acero inoxidable	319126	2



18-3387
KIT BOMBA AGUA
Sin alojamiento
Reemplaza: 432956

— CONTIENE —

Ref #	Desc.	O.E. #	Cant.
18-2703	Casquillo	314008	1
18-3053-1	Impulsor	396725	1
18-2705	Retén	315748	1
18-3133	Tornillo	331979	4
18-7174	Aro tórico	326649	1
18-7481	Aro tórico	324981	1
18-2709	Junta platina desgaste	336530	1
18-3126	Platina desgaste	321940	1
18-3127	Impulsor platina	319275	1
18-3138	Chaveta	334897	1
18-3299	Llave	331107	1
18-3153	Tornillo acero inoxidable	908158	1



18-3388
KIT BOMBA AGUA
Sin alojamiento
Reemplaza: 386533, 389143

— CONTIENE —

Ref #	Desc.	O.E. #	Cant.
18-0969	Junta alojamiento impulsor	319586	1
18-3108	Llave acero inoxidable	323950	1
18-2703	Casquillo	314008	1
18-3127	Impulsor platina	319275	1
18-2705	Retén	315748	1
18-3082	Impulsor	382547	1
18-3153	Tornillo acero inox	334597	1
18-2709	Junta platina desgaste	336530	1
18-3133	Tornillo acero inoxidable	331979	4
18-3126	Platina desgaste	321940	1



18-3389
KIT BOMBA COMBUSTIBLE
Con alojamiento
Reemplaza: 436957

— CONTIENE —

Ref #	Desc.	O.E. #	Cant.
18-7481	Aro tórico	324981	1
18-2703	Casquillo	314008	1
18-3053-1	Impulsor	396725	1
18-3127	Impulsor platina	319275	1
18-2705	Retén	315748	1
18-3133	Tornillo acero inox	908158	1
18-3299	Llave	331107	1
18-7174	Aro tórico	326649	1
18-2709	Junta platina desgaste	336530	1
18-3129	Alojamiento	435673	1
18-3138	Chaveta	334897	1
18-3126	Platina desgaste	321940	1



18-3390
KIT BOMBA AGUA
Sin alojamiento
Reemplaza: 395060

— CONTIENE —

Ref #	Desc.	O.E. #	Cant.
18-3059	Impulsor	397131, 435821	1
18-2557	Junta impulsor	324701, 338484	1
18-3299	Chaveta	331107	1
18-7158	Aro tórico	310967, 310585	1
18-3135	Tornillo acero inoxidable	306643	2
18-2703	Casquillo	314008	1
18-2704	Casquillo	320943	1
18-2706	Casquillo	321008	1
18-3136	Tornillo acero inox	323626	4
18-2769	Goma retén	332000	1
18-3133	Tornillo acero inoxidable	331979	4
18-3346	Tapa acoplamiento platina.	435027	1
18-3138	Llave impulsor	334897	1



18-3391
KIT BOMBA AGUA
Con alojamiento
Reemplaza: 395072

— CONTIENE —

Ref #	Desc.	O.E. #	Cant.
18-3346	Tapa y acoplamiento platina.	435027	1
18-2769	Aro tórico	332000	1
18-2557	Junta platina impulsor	338484, 324701	1
18-2704	Casquillo	320943	1
18-3136	Tornillo acero inoxidable	323626	4
18-3299	Llave	331107	1
18-3153	Tornillo acero inox	908158	1

**18-3392
KIT BOMBA AGUA**

Con alojamiento
Reemplaza: 434421

— CONTIENE —

Ref #	Desc.	O.E. #	Cant.
18-3059	Impulsor	395864, 397131, 435821	1
18-3346	Tapa y acoplamiento platina.	435027	1
18-3299	Chaveta	331107	1
18-7158	Aro tórico	310967, 310585	1
18-3135	Tornillo acero inox	306643	2
18-2703	Casquillo	314008	1
18-2704	Casquillo	320943	1
18-2706	Casquillo	321008	1
18-3136	Tornillo acero inox	323626	4
18-2769	Goma retén	332000	1
18-2557	Junta impulsor	324701, 338484	1
18-3133	Tornillo acero inox	331979	4



**18-3393
KIT BOMBA AGUA**

Con alojamiento
Reemplaza: 395073, 388644

— CONTIENE —

Ref #	Desc.	O.E. #	Cant.
18-3043	Impulsor	389642	1
18-2557	Junta impulsor	324701, 338484	1
18-3346	tapa y acoplamiento platina.	435027	1
18-3108	Llave bomba de agua	323950	1
18-0110	Junta alojamiento	324670	1
18-7158	Aro tórico	310967, 310585	1
18-3135	Tornillo acero inox	306643	2
18-2703	Casquillo	314008	1
18-2704	Casquillo	320943	1
18-2706	Casquillo	321008	1
18-3136	Tornillo acero inox	323626	4
18-2769	Aro tórico	332000	1
18-7143	Aro tórico	322501	1
18-3133	Tornillo acero inox	331979	4



**18-3394
KIT BOMBA AGUA**

Sin alojamiento
Reemplaza: 433548

— CONTIENE —

Ref #	Desc.	O.E. #	Cant.
18-7481	Aro tórico	324981	1
18-2708	Casquillo	333758	1
18-2709	Junta platina desgaste	336530	1
18-3104-1	Impulsor	432941	1
18-3138	Chaveta	334897	1
18-2705	Retén	315748	1
18-3133	Tornillo acero inox	331979	4
18-3126	Platina desgaste	321940	1



**18-3399
KIT BOMBA AGUA**

Con alojamiento
Reemplaza: 396933

— CONTIENE —

Ref #	Desc.	O.E. #	Cant.
18-7134	Aro tórico	303059	1
18-3337	Casquillo	315837	1
18-3368	Impulsor	396809	1
18-2709	Junta platina desgaste	336530	1
18-3369	Tornillo (Corto)	319126	2
18-2705	Retén	315748	1
18-3336	Alojamiento	384087	1
18-3365	Tornillo (Largo)	909533	2
18-3343	Platina desgaste	320981	1



18-3400
KIT BOMBA AGUA
 Sin alojamiento
 Reemplaza: 391698



— CONTIENE —

Ref #	Desc.	O.E. #	Cant.
18-3050	Impulsor	386084	1
18-3178	Impulsor platina	318995	1
18-3179	Tapa bomba de agua	324097	1
18-3329	Casquillo	302497	1
18-2392	Casquillo	327035	1
18-2025	Retén aceite	318972	1
18-7116	Aro tórico	303097	1
18-3369	Tornillo	319126	4
18-3326	Pin	300771	1
18-7139	Aro tórico	319085	1

18-3401
KIT BOMBA AGUA
 Sin alojamiento



Reemplaza: 395271, 394394

— CONTIENE —

Ref #	Desc.	O.E. #	Cant.
18-3051	Impulsor	395289	1
18-3360	Junta	329398	1
18-3358	Tapa	328773	1
18-7440-1	Aro tórico	301967	2
18-2013	Retén aceite	321786	1
18-3329	Casquillo	302497	1
18-0108	Junta	324449	1
18-3133	Tornillo acero inox	331979	4

18-3402
KIT BOMBA AGUA
 Sin alojamiento
 Reemplaza: 382296



— CONTIENE —

Ref #	Desc.	O.E. #	Cant.
18-3003	Impulsor	377178	1
18-3102	Impulsor platina	305303	1
18-2891	Junta	303339	1
18-3326	Pin	300771	1
18-3329	Casquillo	302497	1
18-2023	Retén aceite	313282	1

18-3403
KIT BOMBA AGUA
 SIN ALOJAMIENTO
 Reemplaza: 388644



— CONTIENE —

Ref #	Desc.	O.E. #	Cant.
18-7158	Aro tórico	310585	1
18-3108	Llave	308928	1
18-2703	Casquillo	314008	1
18-3135	Tornillo	306643	4
18-2026	Retén	321453	1
18-3136	Tornillo alojamiento	323626	1
18-3043	Impulsor	389642	1
18-3346	Tapa y acomplamiento platina	435027	1
18-2536	Junta	321120	1
18-2704	Casquillo	320943	1

18-3315-2
KIT BOMBA AGUA
 Con alojamiento
 Reemplaza: 435929, 5001595
 Para: 90/115SL (1995-SUP), 120/125ESX (1993-94), 120/130/140/150/175/V-6/V-8 (1993-SUP)



— CONTIENE —

Ref #	Desc.	O.E. #	Cant.
18-2557	Junta	324701	1
18-3405	Alojamiento, WP	435485	1

TORNILLOS ACERO INOXIDABLE

Ref No.	O.E. #	Tamaño
18-3133	330619, 344470	1/4 x 20 x 11/16"
18-3135 ①③	306643	1/8 x 20 x 1/2"
18-3136 ①③	323626	1/4 x 20 x 13/4"
18-3153	908158	1/4 x 20 x 1/2"
18-3365	909533	1/4 x 20 x 1"
18-3369	319126	1/4 x 20 x 1"
18-4276 ②③	324334	1/4 x 20 x 1 1/32"

① Envase estandar de 2 ② Envase estandar de 5

APLICACIONES EMPIEZAN EN LA SIGUIENTE PÁGINA
 ③ Precio por pieza. Para pedir precio por envase -9 a la referencia.

HP	Año	Impulsor	Impulsor platina	Platina y tapa	Tapa	Kit reparación	Kit bomba S/ aloj.	Kit bomba c/aloj.	Kit alojamiento
2 Jr, Colt	1985-90	18-3090	—	—	—	—	—	—	—
2.5	1987-06	18-3015	—	—	—	—	—	—	—
3	1952-78	18-3001	—	—	—	18-3201	—	—	—
3.5	1987-06	18-3015	—	—	—	—	—	—	—
4	1969-72	18-3001	—	—	—	18-3201	—	—	—
4 ⑦	1973-83	18-3001	—	—	—	18-3201	—	—	—
4 ⑧	1976-80	18-3090	—	—	—	—	—	—	—
4 Deluxe	1980-97	18-3091	—	—	—	—	—	—	—
4 Ultra Excel	1987-06	18-3015	—	—	—	—	—	—	—
4.5	1980-97	18-3091	—	—	—	—	—	—	—
5	1965-68	18-3001	—	—	—	—	—	—	—
5 (4-tiempos)	1998-sup	18-3091	—	—	—	—	—	—	—
5.5	1954-64	18-3001	18-3102	—	—	18-3202	—	—	—
6	1952-78	18-3001	18-3102	—	—	18-3202	—	—	—
6	1979	18-3090	—	—	—	—	—	—	—
6	1984-97	18-3091	—	—	—	—	—	—	—
6 (4-tiempos)	1998-sup	18-3091	—	—	—	—	—	—	—
7.5	1954-58	18-3001	18-3102	—	—	18-3202	—	—	—
8 (2-tiempos)	1986-97	18-3091	—	—	—	—	—	—	—
9.5	1964-73	18-3003	18-3102	—	—	—	18-3402	—	—
10	1958-63	18-3003	18-3102	—	—	—	18-3402	—	—
10	1949-57	18-3002	18-3103	—	—	18-3203	18-3377	—	—
9.9/15	1974-sup	18-3050	18-3178	—	18-3179	—	18-3400	18-3327	18-3180
9.9/15 (4-tiempos)	1995-sup	18-3050	18-3178	—	18-3179	—	18-3400	18-3327	18-3180
15,18	1953-65	18-3002	—	—	—	18-3203	18-3377	—	—
20	1966-73	18-3002	—	—	—	18-3203	18-3377	—	—
20	1982-84	18-3051	—	—	18-3358	—	18-3401	18-3383	18-3363
20	1985-sup	18-3051	18-3359	—	18-3358	—	18-3381	18-3382	18-3367
25	1951-55	18-3006	—	—	—	—	—	—	—
25	1969-78	18-3002	18-3103	—	—	18-3203	18-3377	—	—
25	1979-84	18-3051	—	—	18-3358	—	18-3401	18-3383	18-3363
25	1985-sup	18-3051	18-3359	—	18-3358	—	18-3381	18-3382	18-3367
28	1962-64	18-3006	—	—	—	—	—	—	—
28	1978-sup	18-3051	—	—	18-3358	—	18-3401	18-3383	18-3363
30	1951-57	18-3006	—	—	—	—	—	—	—
30	1984-sup	18-3051	18-3359	—	18-3358	—	18-3381	18-3382	18-3367
33	1962-71	18-3006	—	—	—	—	—	—	—
35	1951-57	18-3006	—	—	—	—	—	—	—
35	1958-59	18-3083	—	—	—	—	—	—	—
35	1976-77	18-3006	—	—	—	—	—	—	—
35	1978-79	18-3051	—	—	—	—	18-3238	—	—
35	1980-82	18-3051	N/A	—	18-3358	—	—	18-3382	18-3367
35	1983-sup	18-3051	18-3359	—	18-3358	—	—	—	—
35 Jet	1992-93	18-3104-1	—	—	—	—	18-3394	—	—
40	1960-70	18-3083	—	—	—	—	—	—	—
40	1971-73	18-3006	—	—	—	—	—	—	—
40 Comm.	1981-90	18-3366	18-3352	—	—	—	18-3379	—	—
40	1984-85	18-3055	18-3343	—	—	—	18-3385	18-3399	18-3336
40	1986-88	18-3368	18-3343	—	—	—	18-3385	18-3399	18-3336
40	1989-98	18-3104-1	—	—	—	—	18-3394	—	—
40	1999-sup	18-3053-1	—	—	—	—	18-3394	—	—

① Excepto bombas cromadas

② Excepto modelos SL 1995 y Sup/FFI

③ "S" Sufijo

④ "F" Sufijo

⑤ Excepto 1993-94 25" & 30" V6 & V8

⑦ Para bomba de agua de un solo tubo

⑥ Caja engranajes 90°

HP	Año	Impulsor	Impulsor platina	Platina y tapa	Tapa	Kit reparación	Kit bomba S/ aloj.	Kit bomba c/aloj.	Kit alojamiento
45/55 Comm.	1985	18-3055	—	—	—	—	18-3380	—	18-3336
45/55	1989	18-3368	18-3343	—	—	—	18-3385	18-3399	18-3336
45/55 Comm.	1986-88,	18-3368	—	—	—	—	18-3385	18-3399	18-3336
48	1987-88	18-3368	18-3343	—	—	—	18-3385	18-3399	18-3336
48	1989-96	18-3104-1	18-3127	—	—	—	18-3394	—	—
50	1971-78	18-3083	18-3343	—	—	—	18-3376	—	—
50	1979-85	18-3055	18-3343	—	—	—	18-3380	18-3378	18-3336
50	1986-88	18-3368	18-3343	—	—	—	18-3385	18-3399	18-3336
50	1989-98	18-3104-1	—	—	—	—	18-3394	—	—
55	1968-69	18-3082	—	—	—	—	—	—	—
55	1976-78	18-3083	—	—	—	—	—	—	18-3336
55	1979-85	18-3055	18-3343	—	—	—	18-3380	18-3378	18-3336
60	1964-67	—	—	—	—	—	—	—	—
60	1970-71	18-3082	—	—	—	—	—	—	—
60	1980-85	18-3055	—	—	—	—	18-3380	18-3378	18-3336
60	1986-94	18-3053-1	18-3127	—	—	—	18-3387	18-3389	—
60	1995-sup	18-3053-1	18-3127	—	—	—	18-3387	—	—
65	1968	—	—	—	—	—	—	—	—
65	1972-73	18-3082	—	—	—	—	—	—	—
65 Comm.	1984-94	18-3053-1	18-3127	—	—	—	18-3387	18-3389	—
65 Comm.	1995-sup	18-3053-1	18-3127	—	—	—	18-3387	—	—
70	1974-78	18-3082	18-3127	—	—	—	18-3388	—	—
70	1979-94	18-3053-1	18-3127	—	—	—	18-3387	18-3389	—
70	1995-sup	18-3053-1	18-3127	—	—	—	18-3387	—	—
75	1960-65	—	—	—	—	—	—	—	—
75	1974-78	18-3082	18-3127	—	—	—	18-3388	—	—
75	1979-88	18-3053-1	18-3127	—	—	—	18-3387	18-3389	18-3129
80	1966-67	—	—	—	—	—	—	—	—
85	1968	—	—	—	—	—	—	—	—
85	1969-72	18-3044	18-3182	—	—	—	—	—	—
85	1973-77	18-3043	18-3182	—	—	—	18-3384	—	—
85	1978	18-3043	—	18-3346	—	—	—	18-3393⑦	18-3391
85	1979-95	18-3059	—	18-3346	—	18-3211	18-3390	18-3392	18-3391
90	1964-68	—	—	—	—	—	—	—	—
90	1979-sup	18-3059	—	18-3346	—	18-3211	18-3390	18-3392②	18-3391
90 SL,DI	1995 & SUP	18-3059	—	18-3346	—	18-3211	18-3390	18-3315-2	18-3405
100	1969-72	18-3044	—	—	—	—	—	—	—
100	1979-sup	18-3059	—	18-3346	—	18-3211	18-3390	18-3392	18-3391
100 Comm. ①	1984-sup	18-3059	—	18-3346	—	18-3211	18-3390	18-3392	18-3391
105 Comm.	1998-2001	18-3059	—	18-3346	—	18-3211	18-3390	18-3315-2	18-3405
115	1969-70	18-3044	—	—	—	—	—	—	—
115	1973-76	18-3043	—	—	—	—	18-3384	—	—
115	1977-78	18-3043	—	18-3346	—	—	—	18-3393⑦	18-3391
115	1979-sup	18-3059	—	18-3346	—	18-3211	18-3390	18-3392②	18-3391
115 SL,DL	1995 & SUP	18-3059	—	18-3346	—	18-3211	18-3390	18-3315-2	18-3405
120 25" ④	1993-2000	18-3059	—	18-3346	—	18-3211	18-3390	18-3315-2	18-3405
125	1971-72	18-3044	—	—	—	—	—	—	—
125 ESX 25" ③	1993-94	18-3059	—	18-3346	—	18-3211	18-3390	18-3392	18-3391
125 ESX 25"	1994-95	18-3059	—	18-3346	—	18-3211	18-3390	18-3392	18-3391
125 ESX 25" ④	1993-94	18-3059	—	18-3346	—	18-3211	18-3390	—	—
130	1997 & SUP	18-3059	—	18-3346	—	18-3211	18-3390	18-3315-2	18-3405

① Excepto bombas cromadas

② Excepto modelos SL 1995 & Sup/FFI

③ "S" Sufijo

④ "F" Sufijo

⑤ Excepto 1993-94 25" & 30" V6 & V8

⑦ Para bombas de agua de un solo tubo

⑧ Caja de engranajes 90°

HP	Año	Impulsor	Impulsor platina	Platina y tapa	Tapa	Kit reparación	Kit bomba S/ aloj.	Kit bomba c/aloj.	Kit alojamiento
130 25"	1994-2000	18-3059	—	18-3346	—	18-3211	18-3390	18-3315-1	18-3405
135	1973-75	18-3043	18-3182	—	—	18-3210	18-3384	—	—
135	1976	18-3043	18-3182	—	—	—	—	—	—
135 25"	2001	18-3059	—	18-3346	—	18-3211	18-3390	18-3315-2	18-3405
140	1977-78	18-3043	—	18-3346	—	—	—	18-3393⑦	18-3391
140	1979-sup	18-3059	—	18-3346	—	18-3211	18-3390	18-3392	18-3391
140 25" ④	1993	18-3059	—	18-3346	—	18-3211	18-3390	18-3315-2	18-3405
140 25"	1994-2000	18-3059	—	18-3346	—	18-3211	18-3390	18-3315-2	18-3405
150	1976-78	18-3043	—	18-3346	—	18-3210	—	18-3393⑦	18-3391
150	1979-sup	18-3059	—	18-3346	—	18-3211	18-3390	18-3392	18-3391
150 20"	1993 & SUP	18-3059	—	18-3346	—	18-3211	18-3390	18-3392	18-3391
150 SL 20"	1994-98	18-3059	—	18-3346	—	18-3211	18-3390	18-3315-2	18-3405
150 EL 20"	1996-98	18-3059	—	18-3346	—	18-3211	18-3390	18-3315-2	18-3405
150 25"	1993 & SUP	18-3059	—	18-3346	—	18-3211	18-3390	18-3315-2	18-3405
150 DI	1997 & SUP	18-3059	—	18-3346	—	18-3211	18-3390	18-3315-2	18-3405
150	2000 & SUP	18-3059	—	18-3346	—	18-3211	18-3390	18-3315-2	18-3405
175	1976-78	18-3043	—	18-3346	—	18-3210	—	18-3393⑦	18-3391
175 SL 20"	1994-98	18-3059	—	18-3346	—	18-3211	18-3390	18-3315-2	18-3405
175 EL 20"	1996-98	18-3059	—	18-3346	—	18-3211	18-3390	18-3315-2	18-3405
175 25"	1993 & SUP	18-3059	—	18-3346	—	18-3211	18-3390	18-3315-2	18-3405
175 DI	1997 & SUP	18-3059	—	18-3346	—	18-3211	18-3390	18-3315-2	18-3405
175	2000 & SUP	18-3059	—	18-3346	—	18-3211	18-3390	18-3315-2	18-3405
200	1976-78	18-3043	—	18-3346	—	—	—	18-3393⑦	18-3391
200 Comm.	1990	18-3059	—	18-3346	—	18-3211	18-3390	18-3392	18-3391
200 25" & 30"	1993-97	18-3059	—	18-3346	—	18-3211	18-3390	18-3315-2	18-3405
225 20"	1993 & SUP	18-3059	—	18-3346	—	18-3211	18-3390	18-3392	18-3391
225 25" & 30"	1993-97	18-3059	—	18-3346	—	18-3211	18-3390	18-3315-2	18-3405
235	1978	18-3043	—	18-3346	—	—	—	18-3393⑦	18-3391
235	1979-sup	18-3059	—	18-3346	—	18-3211	18-3390	18-3392	18-3391
V4 Cross 20" & 25"	1993 & SUP	18-3059	—	18-3346	—	18-3211	18-3390	18-3392	18-3391
V4 Loop 20"	1993 & SUP	18-3059	—	18-3346	—	18-3211	18-3390	18-3392	18-3391
V4,V6,V8 ⑤	1982-94	18-3059	—	18-3346	—	18-3211	18-3390	18-3392	18-3391
V6,V8 20"	1993 & SUP	18-3059	—	18-3346	—	18-3211	18-3390	18-3392	18-3391
V6 & V8 25" & 30"	1993 & UP	18-3059	—	18-3346	—	18-3211	18-3390	18-3315-2	18-3405
Sea Drives	1979-Up	18-3059	—	18-3346	—	18-3211	18-3390	18-3392⑥	18-3391

① Excepto Bombas cromadas

② Excepto SL modelos 1995 & Sup/FFI

③ "S" Sufijo

④ "F" Sufijo

⑤ Excepto 1993-94 25" & 30" V6 & V8

⑦ para Bombas de agua con 1 tubo

⑧ Caja engranajes 90°

 <p>18-3563 VALVULA V-6 Crossflow Reemplaza: 321027</p>	 <p>18-3564 VALVULA V-4 Crossflow Reemplaza: 318395</p>	 <p>18-1219 CASQUILLO V-6 Crossflow Reemplaza: 320880</p>	<p>PACK. DE 2</p>  <p>18-1221 18-1221-9① TAPA VALVULA V-4 / V-6 Loop Charge Reemplaza: 330273</p>
 <p>18-3562 TAPA VALVULA V-6 Crossflow Reemplaza: 321222</p>	 <p>18-1243 MUELLE VALVULA V-4 / V-6 Crossflow Reemplaza: 317245</p>	 <p>18-1222 JUNTA TERMOSTATO V-4 / V-6 Loop Charge Reemplaza: 394408</p>	 <p>18-3567 VALVULA GOMA V-6 Crossflow Reemplaza: 321221</p>

① Precio por pack



**18-3565
RETENEDOR**
V-6 Crossflow
Reemplaza: 321220



**18-2391
CASQUILLO**
V-4 Crossflow
Reemplaza: 321692



**18-3500
TERMOSTATO**
Reemplaza: 394409, 434137
Para: 3 cil. (1992 & SUP),
90° Looper (1990-1992)
140°



**18-3544
TERMOSTATO**
Reemplaza: 435491
Para: E100 (2004-06), E110 (04-06), E115 (2002-06), E75 (2002-03), E90 (2002-03), E150 (1991-94), E175 (1991-94), J105 (2003), J115 (2002-06), J150 (1991-92, 1993-94, 2002-06), J175 (1991-92, 1994, 2002-06), J90 (2004-06)



**18-3545
TERMOSTATO 130°**
Reemplaza: 437090
Para: E115 (1997),
E135, E150, E175 (2000-06)



**18-3546
TERMOSTATO 130°**
Reemplaza: 5001036
Para: E200, E225, E250 (2000-05),
J200, J225, J250 (2000-01)



**18-3543
TERMOSTATO 143°**
Reemplaza: 393659, 434841,
378065, 508626, 5005440
Para: 40-250hp E-tech, 6-55hp, Cross V4 &
V6, 9.9 4-tiempos (1994-01), 15 4-tiempos
(1994-01)



**18-3557
TERMOSTATO 143°**
Reemplaza: 396987, 382385



**18-3561
TERMOSTATO**
Reemplaza: 436195
143°



**18-1506
TERMOSTATO 143°**
Reemplaza: 394411
Para: 10/15 (1993-95), 60/125/185 (1989-90),
65 (1987-89), 70/200/225 (1986-90),
120/140/300 (1985-90), 275 (1985-88)



**18-3560
TERMOSTATO**
Reemplaza: 384719
105°
Para mayoría 3 & 4 cil., 1985-90

① 18-3669D Display Package



**18-3669
KIT TERMOSTATO**
— CONTIENE —

Ref #	Descripción	O.E. #
18-3557	Termostato	396987
18-2548	Junta tapa termostato	332108
18-0929	Junta termostato	313416

① 18-3673D Display Package



**18-3673
KIT TERMOSTATO**
V-4 Crossflow
Use termostato 18-3543

① 18-3674D Display Package



**18-3674
KIT TERMOSTATO**
V-6 Crossflow
Use termostato 18-3543



**18-3566
CODO MANGUERA**
Reemplaza: 331894



**18-1507
RETÉN TERMOSTATO**
Reemplaza: 335981
Para: 60° V-4 & V-6



**18-1734
RETÉN TERMOSTATO**
Reemplaza: 334742
Para: OMC termostato aplicación 6, 8, 10, 15,
40, 48, 50 HP (1989-94)

APLICACIÓN EN LA PÁGINA 67

① Referencias acabadas en "D" envasadas - Referencia normal no envasada

Crossflow motor V-4

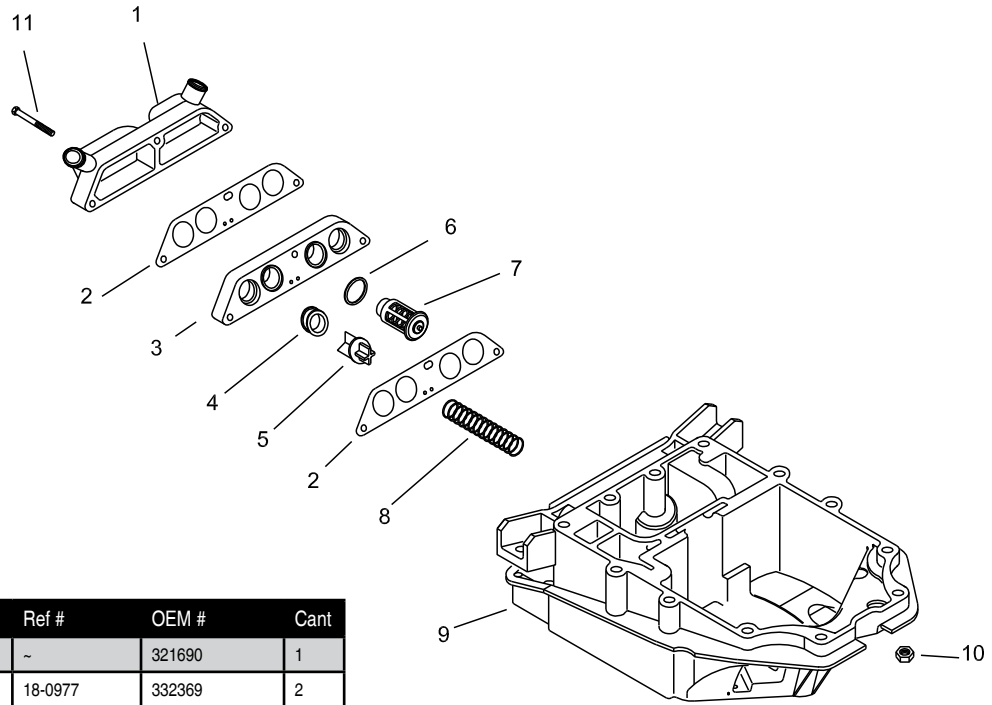

Fig. #	Descripción	Ref #	OEM #	Cant
1	Tapa	~	321690	1
2	Junta	18-0977	332369	2
3	Cuerpo válvula	~	321693	1
4	Casquillo	18-2391	321692	2
5	Válvula	18-3564	318395	2
6	Junta termostato	18-0675	321932	2
7	Termostato	18-3543	434841, 393659	2
8	Muelle	18-1243	317245	2
9	Adaptador	~	331039	1
10	Tuerca	~	306422	4
11	Tapa tornillo	~	305652	3

Crossflow motor V-6

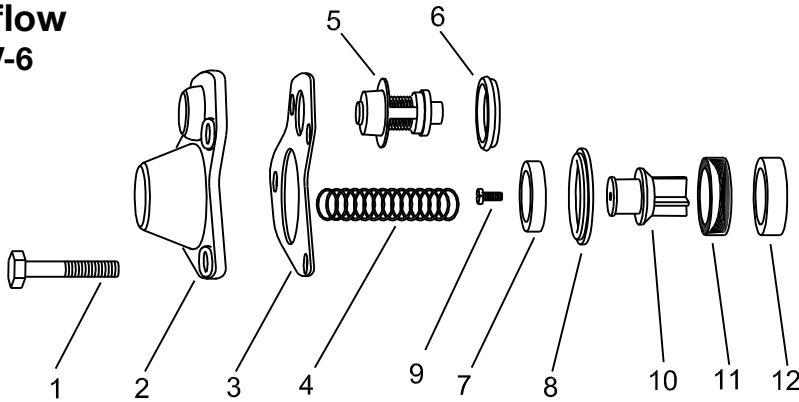

Fig. #	Descripción	Ref #	OEM #	Cant	Fig. #	Descripción	Ref #	OEM #	Cant
1	Tornillos	—	306778	4	7	Retenedor	18-3565	321220	1
2	Tapa	—	321013	1	8	Retén	18-3567	321221	1
3	Junta	18-2546	321184	1	9	tornillo acero inox	18-3135	306643	1
4	Muelle	18-1243	317245	1	10	Válvula	18-3563	321027	1
5	Termostato	18-3543	393659	1	11	Casquillo	18-1219	320880	1
6	Junta termostato	18-0182	310058	1	12	Tapa válvula	18-3562	321222	1

HP	Años	Kit termostato	Termostato	Válvula	Asiento válvula	Válvula diafragma	Válvula retenedor	Tapa válvula	Muelle válvula	Casquillo
5	1965-68, 1986	18-3672 ⑤	18-3543	—	—	—	—	—	—	—
5.5	1959-64	18-3672 ⑤	18-3543	—	—	—	—	—	—	—
6	1965-79, 1986	18-3672 ⑤	18-3543	—	—	—	—	—	—	—
7.5	1980-86	18-3672 ⑤	18-3543	—	—	—	—	—	—	—
8	1986	18-3672 ⑤	18-3543	—	—	—	—	—	—	—
9.5	1964-73	18-3672 ⑤	18-3543	—	—	—	—	—	—	—
9.9	1974-86	18-3672 ⑤	18-3543	—	—	—	—	—	—	—
10	1959-63	18-3672 ⑤	18-3543	—	—	—	—	—	—	—
15	1974-86	18-3672 ⑤	18-3543	—	—	—	—	—	—	—
18	1959-73	18-3672 ⑤	18-3543	—	—	—	—	—	—	—
20	1981-94	18-3672 ⑤	18-3543	—	—	—	—	—	—	—
25 ①	1969-94	18-3672 ⑤	18-3543	—	—	—	—	—	—	—
28	1989-94	18-3672 ⑤	18-3543	—	—	—	—	—	—	—
30	1986-94	18-3672 ⑤	18-3543	—	—	—	—	—	—	—
35	1959, 1976-94	18-3672 ⑤	18-3543	—	—	—	—	—	—	—
40	1960-69	18-3672 ⑤	18-3543	—	—	—	—	—	—	—
45	1989-92 ②	18-3672 ⑤	18-3543	—	—	—	—	—	—	—
50	1971-75, 1979, 1981-86	18-3672 ⑤	18-3543	—	—	—	—	—	—	—
55	1976-92 ③	18-3672 ⑤	18-3543	—	—	—	—	—	—	—
60	1969-70	18-3669 ⑤	18-3557	—	—	—	—	—	—	—
60	1980-86	18-3672 ⑤	18-3543	—	—	—	—	—	—	—
60, 60TTL	1993	—	18-3561	—	—	—	—	—	—	—
65	1971-73	18-3669	18-3557	—	—	—	—	—	—	—
65	1993	—	18-3561	—	—	—	—	—	—	—
65C	1984-86	18-3669	18-3557	—	—	—	—	—	—	—
65 Jet	1994-95	18-3673	18-3543	18-3564	—	—	—	—	18-1243	18-2391
70	1974-86	18-3669	18-3557	—	—	—	—	—	—	—
70,70TTL	1993	—	18-3561	—	—	—	—	—	—	—
75	1978-88	18-3669	18-3557	—	—	—	—	—	—	—
80 Jet	1994-95	18-3673	18-3543	18-3564	—	—	—	—	18-1243	18-2391
85	1978-80	18-3673	18-3543	18-3564	—	—	—	—	18-1243	18-2391
85	1993-95	18-3673	18-3543	18-3564	—	—	—	—	18-1243	18-2391
88	1987-95	18-3673	18-3543	18-3564	—	—	—	—	18-1243	18-2391
90 ④	1983-95	18-3673	18-3543	18-3564	—	—	—	—	18-1243	18-2391
90 Jet	1994	18-3673	18-3543	18-3564	—	—	—	—	18-1243	18-2391
100	1979-80	18-3673	18-3543	18-3564	—	—	—	—	18-1243	18-2391
100	1990-95	18-3673	18-3543	18-3564	—	—	—	—	18-1243	18-2391
100 Comm	1984-95	18-3673	18-3543	18-3564	—	—	—	—	—	—
110	1985-89	18-3673	18-3543	18-3564	—	—	—	—	18-1243	18-2391
112	1994-95	18-3673	18-3543	18-3564	—	—	—	—	18-1243	18-2391
115 ④	1978-95	18-3673	18-3543	18-3564	—	—	—	—	18-1243	18-2391
120	1988-91	—	—	—	—	18-1222	—	18-1221	—	—
140	1978-85	18-3673	18-3543	18-3564	—	—	—	—	18-1243	18-2391
140	1988-91	—	—	—	—	18-1222	—	18-1221	—	—
150	1978-91	18-3672 ⑤	18-3543	18-3563	18-1219	18-3567	18-3565	18-3562	18-1243	18-0182
155	1984-91	18-3672 ⑤	18-3543	18-3563	18-1219	18-3567	18-3565	18-3562	18-1243	18-0182
175	1977-91	18-3672 ⑤	18-3543	18-3563	18-1219	18-3567	18-3565	18-3562	18-1243	18-0182
185	1984-85	18-3672 ⑤	18-3543	18-3563	18-1219	18-3567	18-3565	18-3562	18-1243	18-0182
200	1977-83	18-3672 ⑤	18-3543	18-3563	18-1219	18-3567	18-3565	18-3562	18-1243	18-0182
200	1988-93	—	—	—	—	18-1222	18-3565	18-1221	—	—
225	1988-93	—	—	—	—	18-1222	18-3565	18-1221	—	—
235	1978-85	18-3672 ①	18-3543	18-3563	18-1219	18-3567	18-3565	18-3562	18-1243	18-0182

① Todos los modelos 1989-91 excepto DR & DT

② Comercial

③ También comercial

④ Excepto modelos 60°

⑤ Para kit termostato completo incluyendo juntas y muelles usar 18-3674



LOS AROS PISTÓN TAMBIÉN SE SUMINISTRAN POR SEPARADO

KIT PISTONES
(VER TABLA PARA USOS ESPECÍFICOS)

HP	Cil.	Medida	Pistón	OEM Ref No.	Aro pistón	OEM Ref No.	OEM Ref No.	Clips	OEM Ref No.
9.9/15	2	2.188 / std.	—	397487	18-3931	386279	N/D	—	325262
9.9/15	2	2.218 / .030	—	396574	18-3933	386280	N/D	—	325262
9.9/15	2	2.188 / std.	18-4061	387660	18-3931	386279	N/D	—	325262
9.9/15	2	2.218 / .030	18-4062	387661	18-3933	386280	N/D	—	325262
25-35	2	3.000 / std.	18-4107	392621	18-3910	396377	320954	18-4290 ①	317831
25-35	2	3.020 / .020	—	N/D	18-3911	396378	320954	18-4290 ①	317831
25-35	2	3.030 / .030	—	396576	18-3912	396379	320954	18-4290 ①	317831
35-60	2 & 3	3.187 / std.	—	391798	18-3913	391170, 434107	322188	18-4290 ①	317831
35-60	2 & 3	3.207 / .020	—	N/D	18-3914	N/D	322188	18-4290 ①	317831
35-60	2 & 3	3.217 / .030	—	396581	18-3915	391416, 434109	322188	18-4290 ①	317831
60-75	3	3.000 / std.	18-4124	387284	18-3910	396377	320954	18-4290 ①	317831
60-75	3	3.020 / .020	18-4114	387285	18-3911	396378	320954	18-4290 ①	317831
60-75	3	3.030 / .030	18-4104	396583	18-3912	396379	320954	18-4290 ①	317831
50-70	3	3.187 / std.	18-4063	394461	18-3913	391170, 434107	322188	18-4290 ①	317831
50-70	3	3.217 / .030	18-4064	398483	18-3915	391416, 434109	322188	18-4290 ①	317831

KIT PISTONES SIERRA V-4/V-6
(VER TABLA PARA USOS ESPECÍFICOS)

Modelo/HP	Cil.	Medida	Pistón	OEM Ref #	Aro pistón	OEM Ref #	Bulón	OEM Ref #	Clips	OEM Ref #
85-300	4 & 6	3.5	18-4120	393271, 393924	18-3904	394930	18-4280	327861	18-4290 ①	317831
85-300	4 & 6	3.52	18-4110	—	18-3906	396503, 385662	18-4280	327861	18-4290 ①	317831
85-300	4 & 6	3.53	18-4100	396585, 396588	18-3905	396504	18-4280	327861	18-4290 ①	317831
150-235	4 & 6	3.625	18-4123	392455	18-3907	390509	18-4280	327861	18-4290 ①	317831
150-235	4 & 6	3.645	18-4113	N/D	—	N/D	18-4280	327861	18-4290 ①	317831
150-235	4 & 6	3.655	—	396587	18-3908	390510	18-4280	327861	18-4290 ①	317831

Loopers

120-300	4 & 6	3.685 (babor)	18-4065	432072, 432969	18-3975	431870	N.S.S.	—	18-4292	326765
120-300	4 & 6	3.685 (estribor)	18-4066	432073, 432970	18-3975	431870	N.S.S.	—	18-4292	326765
120-300	4 & 6	3.715 (babor)	18-4067	432077, 433003	—	431844	N.S.S.	—	18-4292	326765
120-300	4 & 6	3.715 (estribor)	18-4068	432078, 433004	—	431844	N.S.S.	—	18-4292	326765
120-300	4 & 6	3.500 (babor)	—	393566	18-3904	394930	18-4280	327861	18-4290 ①	317831
120-300	4 & 6	3.500 (estribor)	—	391481	18-3904	394930	18-4280	327861	18-4290 ①	317831
120-300	4 & 6	3.520 (babor)	—	N/D	18-3906	396503, 385662	18-4280	327861	18-4290 ①	317831
120-300	4 & 6	3.520 (estribor)	18-4111	N/D	18-3906	396503, 385662	18-4280	327861	18-4290 ①	317831
120-300	4 & 6	3.530 (babor)	18-4102	393612	18-3905	396504	18-4280	327861	18-4290 ①	317831
120-300	4 & 6	3.530 (estribor)	18-4101	391653	18-3905	396504	18-4280	327861	18-4290 ①	317831
185, 200-225	6	3.5995 (babor)	estándar 18-4190	436860	18-3901	436254	—	—	—	—
185, 200-225	6	3.5995 (estribor)	estándar 18-4079	436859	18-3901	436254	—	—	—	—
185, 200-225	6	3.5995 (babor)	0.02 18-4195	439015	—	439538	—	—	—	—
185, 200-225	6	3.5995 (estribor)	0.02 18-4086	439516	—	439538	—	—	—	—

① Precio por pieza. Para pedir envasado añada 9 a la referencia.

PISTÓN EN LINEA & APLICACIÓN AROS

HP	Año	Cil	Medida Estand	Pistón estand.	.020 OS Pistón	.030 OS Pistón	Aros estand	Aros .020 OS	Aros .030 OS
5/6/8/7.5	1986-95	2	1.937	18-4069	—	—	18-3972	—	—
9.9/15	1974-80	2	2.188	18-4061	—	18-4062	18-3931	—	18-3933
9.9/15	1981-93	2	2.188	—	—	—	18-3931	—	18-3933
10	1988-90	2	2.188	—	—	—	18-3931	—	18-3933
14	1988-90	2	2.188	—	—	—	18-3931	—	18-3933
15 4-tiempos	1995-UP	2	2.188	—	—	—	18-3931	—	18-3933
18 Jet	1995-98	2	3	18-4107	—	—	18-3910	18-3911	18-3912
20	1981-99	2	3	18-4107	—	—	18-3910	18-3911	18-3912
25	1977-80	2	3	—	—	—	18-3910	18-3911	18-3912
25	1981-96	2	3	18-4107	—	—	18-3910	18-3911	18-3912
25	1983-93	2	3.187	—	—	—	18-3913	18-3914	18-3915
28	1986-96	2	3	18-4107	—	—	18-3910	18-3911	18-3912
28 Jet	1995-96	2	3.187	—	—	—	18-3913	18-3914	18-3915
30	1984-98	2	3	18-4107	—	—	18-3910	18-3911	18-3912
35	1976-80	2	3	—	—	—	18-3910	18-3911	18-3912
35	1981-92	2	3	18-4107	—	—	18-3910	18-3911	18-3912
35	1986-87	2	3.187	—	—	—	18-3913	18-3914	18-3915
35 Jet	1990-98	2	3.187	—	—	—	18-3913	18-3914	18-3915
40	1975-83	2	3.187	—	—	—	18-3913	18-3914	18-3915
40	1984-98	2	3.187	—	—	—	18-3913	18-3914	18-3915
40 Comm.	1981-97	2	3.187	—	—	—	18-3913	18-3914	18-3915
45 Comm.	1985-92	2	3.187	—	—	—	18-3913	18-3914	18-3915
45SS	1987-90	2	3.187	—	—	—	18-3913	18-3914	18-3915
48	1987-97	2	3.187	—	—	—	18-3913	18-3914	18-3915
50	1981-95	2	3.187	—	—	—	18-3913	18-3914	18-3915
50	1995-98	3	3.187	18-4063	—	18-4064	18-3913	18-3914	18-3915
55	1976-79	2	3.187	—	—	—	18-3913	18-3914	18-3915
55 Comm.	1980-95	2	3.187	—	—	—	18-3913	18-3914	18-3915
60	1980-85	2	3.187	—	—	—	18-3913	18-3914	18-3915
60 (49 CID Modelo)	1986-88	3	3	18-4124	18-4114	18-4104	18-3910	18-3911	18-3912
60	1986-98	3	3.187	18-4063	—	18-4064	18-3913	18-3914	18-3915
65, 65 Comm.	1972-73	3	3	—	—	—	18-3910	18-3911	18-3912
49 CID Modelo	1984-86	3	3	18-4124	18-4114	18-4104	18-3910	18-3911	18-3912
65	1987-95	3	3.187	18-4063	—	18-4064	18-3913	18-3914	18-3915
65 Jet	1991-95	4	3.5	18-4120	18-4110	18-4100	18-3904	18-3906	18-3905
70	1974-75	3	3	—	—	—	18-3910	18-3911	18-3912
70	1976-85	3	3	18-4124	18-4114	18-4104	18-3910	18-3911	18-3912
70	1986-94	3	3.187	18-4063	—	18-4064	18-3913	18-3914	18-3915
75	1975	3	3	—	—	—	18-3910	18-3911	18-3912
75	1976-88	3	3	18-4124	18-4114	18-4104	18-3910	18-3911	18-3912

PISTONES JOHNSON/EVINRUDE (para aplicaciones V-4, V-6 y V-8 Aplicaciones)

HP	Cil	Año	Medida. estand	ESTÁNDAR		.020° OS		.030° OS		Aros estand	Aros .020 OS	Aros .030 OS	Juego cojinetes
				babor	estribor	babor	estribor	babor	estribor				
65 Jet	4	1991-95	3.5	18-4120	18-4120	18-4110	18-4110	18-4100	18-4100	18-3904	18-3906	18-3905	18-1386
80 Jet	4	1991-96	3.5	18-4120	18-4120	18-4110	18-4110	18-4100	18-4100	18-3904	18-3906	18-3905	—
85	4	1979-80, 1991-95	3.5	18-4120	18-4120	18-4110	18-4110	18-4100	18-4100	18-3904	18-3906	18-3905	18-1386
88	4	1987-95	3.5	18-4120	18-4120	18-4110	18-4110	18-4100	18-4100	18-3904	18-3906	18-3905	18-1386
90	4	1981-98	3.5	18-4120	18-4120	18-4110	18-4110	18-4100	18-4100	18-3904	18-3906	18-3905	18-1386
100 ①	4	1979-97	3.5	18-4120	18-4120	18-4110	18-4110	18-4100	18-4100	18-3904	18-3906	18-3905	18-1386
110	4	1986-90	3.5	18-4120	18-4120	18-4110	18-4110	18-4100	18-4100	18-3904	18-3906	18-3905	18-1386
115	4	1974-77	3.5	18-4120	18-4120	18-4110	18-4110	18-4100	18-4100	18-3904	18-3906	18-3905	—
115	4	1978-98	3.5	18-4120	18-4120	18-4110	18-4110	18-4100	18-4100	18-3904	18-3906	18-3905	18-1386

① Excepto modelos 1991 60° V

PISTONES JOHNSON/EVINRUDE (para aplicaciones V-4, V-6 y V-8) (Cont.)

HP	Cil	Año	Medida. estand	ESTÁNDAR		.020" OS		.030" OS		Aros estand	Aros .020 OS	Aros .030 OS	Juego cojinetes
				babor	estribor	babor	estribor	babor	estribor				
120	4	1985-87	3.5	—	—	—	18-4111	18-4102	18-4101	18-3904	18-3906	18-3905	—
120	4	1988-94	3.685	18-4065	18-4066	—	—	18-4067	18-4068	18-3975	—	—	—
125 Comm.	4	1992-95	3.685	18-4065	18-4066	—	—	18-4067	18-4068	18-3975	—	—	—
130	4	1995-98	3.685	18-4065	18-4066	—	—	18-4067	18-4068	18-3975	—	—	—
135	4	1974-76	3.5	18-4120	18-4120	18-4110	18-4110	18-4100	18-4100	18-3904	18-3906	18-3905	—
140	4	1977	3.5	18-4120	18-4120	18-4110	18-4110	18-4100	18-4100	18-3904	18-3906	18-3905	—
140	4	1978-84	3.5	18-4120	18-4120	18-4110	18-4110	18-4100	18-4100	18-3904	18-3906	18-3905	18-1386
140	4	1985-87	3.5	—	—	—	18-4111	18-4102	18-4101	18-3904	18-3906	18-3905	—
140	4	1988-94	3.685	18-4065	18-4066	—	—	18-4067	18-4068	18-3975	—	—	—
1600CC	4	1988	3.5	18-4120	18-4120	18-4110	18-4110	18-4100	18-4100	18-3904	18-3906	18-3905	18-1386
150	6	1973-77	3.5	18-4120	18-4120	18-4110	18-4110	18-4100	18-4100	18-3904	18-3906	18-3905	—
150	6	1978-91	3.5	18-4120	18-4120	18-4110	18-4110	18-4100	18-4100	18-3904	18-3906	18-3905	—
155 Comm.	6	1984-92	3.5	18-4120	18-4120	18-4110	18-4110	18-4100	18-4100	18-3904	18-3906	18-3905	—
175	6	1977-83	3.5	18-4120	18-4120	18-4110	18-4110	18-4100	18-4100	18-3904	18-3906	18-3905	—
175	6	1986-91	3.625	18-4123	18-4123	18-4113	18-4113	—	—	18-3907	—	18-3908	—
185	6	1984-85	3.5	18-4120	18-4120	18-4110	18-4110	18-4100	18-4100	18-3904	18-3906	18-3905	—
185	6	1990-93	—	—	—	—	—	—	—	—	—	—	18-1389
185 Looper	6	1993-94	3.5995	18-4190	18-4079	18-4195	18-4086	—	—	—	—	—	—
200	6	1976-83	3.5	18-4120	18-4120	18-4110	18-4110	18-4100	18-4100	18-3904	18-3906	18-3905	18-1389
200	6	1985-87	3.5	—	—	—	18-4111	18-4102	18-4101	18-3904	18-3906	18-3905	—
200 ①	6	1988-93	3.685	18-4065	18-4066	—	—	18-4067	18-4068	18-3975	—	—	18-1389
200-225 Looper	6	1993-01	3.5995	18-4190	18-4079	18-4195	18-4086	—	—	—	—	—	—
225	6	1985-87	3.5	—	—	—	18-4111	18-4102	18-4101	18-3904	18-3906	18-3905	18-1389
225	6	1988-93	3.685	18-4065	18-4066	—	—	18-4067	18-4068	18-3975	—	—	18-1389
235	6	1980-85	3.625	18-4123	18-4123	18-4113	18-4113	—	—	18-3907	—	18-3908	—
250/300	6	1990-93	3.685	18-4065	18-4066	—	—	18-4067	18-4068	18-3975	—	—	—
2500CC	6	1988	3.5	18-4120	18-4120	18-4110	18-4110	18-4100	18-4100	18-3904	18-3906	18-3905	—
250	6	1988-92	3.685	18-4065	18-4066	—	—	18-4067	18-4068	18-3975	—	—	—
275	8	1988-92	3.685	18-4065	18-4066	—	—	18-4067	18-4068	18-3975	—	—	—
275	8	1985-87	3.5	—	—	—	18-4111	18-4102	18-4101	18-3904	18-3906	18-3905	—
300	8	1988-92	3.685	18-4065	18-4066	—	—	18-4067	18-4068	18-3975	—	—	—
300/3.6L	8	1985-87	3.5	—	—	—	18-4111	18-4102	18-4101	18-3904	18-3906	18-3905	—



Serie Eagle 60°

HP	Cil.	Medida	Piston	OE No.	Aro Pistón	OE No.
90-175	4 & 6	3.600 (babor)	—	436242	18-4088	436353
90-175	4 & 6	3.600(estribor)	—	436243	18-4088	436353
90-175	4 & 6	3.620 (babor)	—	N/D	—	N/D
90-175	4 & 6	3.620 (estribor)	—	N/D	—	N/D
90-175	4 & 6	3.630 (babor)	—	439519	—	436354

Pistón serie eagle OMC V-4/V-6 60°

H.P.	Año	CIL.	MEDIDA. ESTANDAR	STANDARD		.020"O.S.		.030"O.S.		STD.
				(BABOR)	(ESTRIBOR)	(BABOR)	(ESTRIBOR)	(BABOR)	(ESTRIBOR)	AROS
90-175	1991-2000	4 & 6	3.600		—		—		—	18-4088

PISTONES OMC SEA DRIVE

H.P.	AÑO	CIL.	STD. BORE	ESTANDAR		.020"O.S.		.030"O.S.		STD.	.020" O.S.	.030" O.S.
				(BABOR)	(ESTRIBOR)	(BABOR)	(ESTRIBOR)	(BABOR)	(ESTRIBOR)	AROS	AROS	AROS
1.6L	1983-89	4	3.500	18-4120	18-4120	18-4110	18-4110	18-4100	18-4100	18-3904	18-3906	18-3905
1.8L	1987	4	3.500	—	—	—	18-4111	18-4102	18-4101	18-3904	18-3906	18-3905
2.5L	1982, 1984-85	6	3.500	18-4120	18-4120	18-4110	18-4110	18-4100	18-4100	18-3904	18-3906	18-3905
2.6L	1982-86	6	3.625	18-4123	18-4123	18-4113	18-4113	—	—	18-3907	—	18-3908
2.7L	1987	6	3.500	—	—	—	18-4111	18-4102	18-4101	18-3904	18-3906	18-3905
3.6L	1987	8	3.500	—	—	—	18-4111	18-4102	18-4101	18-3904	—	18-3905

LOS FABRICANTES RECOMIENDAN EL CAMBIO DE LAS BIELAS

 <p>TORNILLOS BIELA</p> <table border="1" style="width: 100%; border-collapse: collapse;"> <thead> <tr> <th>Ref #</th> <th>OE#</th> <th>Aplicación</th> </tr> </thead> <tbody> <tr> <td>18-4075</td> <td>308186</td> <td>Para V-4 & V-6 Motores Cross-flow</td> </tr> <tr> <td>18-4075-9①②</td> <td>308186</td> <td>Para V-4 & V-6 Para motores Crossflow</td> </tr> <tr> <td>18-4076</td> <td>330081</td> <td>Para motores V-4 Looper</td> </tr> </tbody> </table>	Ref #	OE#	Aplicación	18-4075	308186	Para V-4 & V-6 Motores Cross-flow	18-4075-9①②	308186	Para V-4 & V-6 Para motores Crossflow	18-4076	330081	Para motores V-4 Looper	 <p>18-1752 BIELA Reemplaza: 394462 Para: 40HP (1999-01), 50HP (1995-98), 60HP (1989-01), 70HP (1986-01)</p>	 <p>18-1753 BIELA Reemplaza: 395861 Para: 30HP (1999-01), 40 HP (1985-02), 45HP (1986-87, 1990-97), 48HP (1987-96), 50HP (1985-02), 55HP (1985-93, 1999-01), 60 HP (1985)</p>
Ref #	OE#	Aplicación												
18-4075	308186	Para V-4 & V-6 Motores Cross-flow												
18-4075-9①②	308186	Para V-4 & V-6 Para motores Crossflow												
18-4076	330081	Para motores V-4 Looper												
 <p>18-4148-1 BIELA Reemplaza: 394488, 5004705 Para motores V-4 Looper y algunas aplicaciones V-6</p>	 <p>18-4712 CAMISA PISTÓN Reemplaza manguito recto con puertos cortados en ID - 3.1875 • OD - 3.453 • Pared - 0.125 • Longitud - 5.556</p>	 <p>18-1352 COJINETE CENTRAL Reemplaza: 378252</p>												
 <p>18-1353 COJINETE CENTRAL Reemplaza: 387041</p>	 <p>18-1360 COJINETE BIELA Reemplaza: 396041</p>													

APICACIONES EMPIEZAN EN LA SIGUIENTE PÁGINA

① PRECIO POR PACK

② Pack de 12



18-1361
COJINETE BIELA
Reemplaza: 387787

18-1296
COJINETE AGUJAS
Reemplaza: 386014
0.750 O.D. x 0.570 I.D. x 0.620 H
Para: 9.9-15 HP



18-1374
COJINETE DE AGUJAS
Reemplaza: 395627



18-1376
COJINETE DE AGUJAS
Reemplaza: 434844



18-1377
COJINETE CENTRAL PRINCIPAL
Reemplaza: 320499



18-1378
COJINETE BIELA
Reemplaza: 388344



18-4040
AGUJAS
(18 agujas)
Reemplaza: 387142, 387139
(extremo de cigüeñal)
(Debe reutilizar la jaula)

JUEGO COJINETES

18-1386
Contiene

Ref No.	Tipo cojinete	OE No.	Can
18-1353	Principal	387041	1
18-1377	Principal	320499	1
18-1374	Pasador	395627	4
18-1395	Inf	385503	1
18-1361	Extr. cig varilla	387787	4

18-1389
Contiene

Ref No.	Tipo cojinete	OE No.	Cant
18-1353	Principal	387041	2
18-1377	Principal	320499	2
18-1376	Pasador	434844	6
18-1396	Inf	390641	1
18-1360	Varilla	396041	4

COJINETES



Ref #	Reemplaza:	Descripción
18-1391	330854	Cojinete cigüeñal inferior
18-1393	393896	Cojinete cigüeñal superior
18-1395	385503	Cojinete cigüeñal inferior
18-1396	390641	Cojinete cigüeñal inferior

H.P.	Año	Camisa	Bielra	Tornillo Biela	Cojinete agujas.	Cojinete biela Completo	Cojinete biela solo	Cojinete central principal	Cojinete cigüeñal	Cojinete sup cigüeñal	Cojinete inf Cigüeñal	Juego de Cojinetes
2 CILINDROS												
9.9	1974-83	-	-	-	-	-	-	-	-	-	-	-
9.9	1974-83	-	-	-	-	-	-	-	-	-	-	-
9.9	1974-80	-	-	-	-	-	-	-	-	-	-	-
9.9	1981-83	-	-	-	-	-	-	-	-	-	-	-
9.9	1986-92	-	-	-	-	-	-	-	-	-	-	-
9.9	1984-97	-	-	-	-	-	-	-	-	-	-	-
9.9	1998	-	-	-	-	-	-	-	-	-	-	-
14 Comm	1988-89	-	-	-	-	-	-	-	-	-	-	-
15	1974-83	-	-	-	-	-	-	-	-	-	-	-
15	1984-97	-	-	-	-	-	-	-	-	-	-	-
15 Comm	1994	-	-	-	18-1296	-	-	-	-	-	-	-
18	1960-68	-	-	-	-	-	18-4040	-	-	-	-	-
18	1970-73	-	-	-	-	-	18-4040	-	-	-	-	-
18 Jet	1996-97	-	-	-	18-1374	18-1378	-	-	-	18-1393	18-1391	-
20	1981-84	-	-	-	18-1374	18-1378	18-4040	-	-	-	18-1391	-
20	1985-97	-	-	-	18-1374	18-1378	-	-	-	18-1393	18-1391	-

APLICACIONES CONTINUAN EN LA PÁGINA SIGUIENTE

H.P.	Año	Camisa	Biela	Tornillo Biela	Cojinetes agujas	Cojinete bielas. Completo	Cojinete bielas. Solo	Cojinete central principal.	Cojinete cigüeñal	Cojinete sup cigüeñal	Cojinete inf cigüeñal	Juego de cojinetes
25	1970-76	-	-	-	-	-	18-4040	-	-	-	-	-
25	1977	-	-	-	-	18-1378	18-4040	-	-	-	18-1391	-
25	1978-80	-	-	18-4075	-	18-1378	18-4040	-	-	-	18-1391	-
25	1981-84	-	-	-	18-1374	18-1378	18-4040	-	-	18-1391	18-1391	-
25 ①	1985-97	-	-	-	-	-	-	-	-	18-1393	18-1391	-
25	1985-97	-	-	18-4075	18-1374	18-1378	-	-	-	-	-	-
25 Comm	1982-84	-	-	-	18-1374	18-1378	18-4040	-	-	-	18-1391	-
25 Comm	1985-97	-	-	-	18-1374	18-1378	-	-	-	18-1393	18-1391	-
28	1987-97	-	-	-	18-1374	18-1378	-	-	-	18-1393	18-1391	-
30	1981-93	-	-	18-4075	18-1374	18-1378	18-4040	-	-	-	-	-
30	1984-1992	-	-	18-4075	-	18-1378	18-4040	-	-	-	-	-
30	1985-97	-	-	-	18-1374	18-1378	18-4040	-	-	18-1393	18-1391	-
30	1984	-	-	-	-	18-1378	18-4040	-	-	-	18-1391	-
33	1965-69	-	-	-	-	18-1378	18-4040	-	-	-	-	-
33	1970	-	-	-	-	18-1378	18-4040	-	-	-	-	-
35	1976-80	-	-	-	-	18-1378	18-4040	-	-	-	18-1391	-
35	1981-84	-	-	18-4075	18-1374	-	18-4040	-	-	-	18-1391	-
35	1985-97	-	-	-	18-1374	18-1378	-	-	-	18-1393	18-1391	-
35	1976-1993	-	-	18-4075	18-1374	18-1378	-	-	-	-	-	-
35	1977	-	-	18-4075	-	-	-	-	-	-	-	-
35	1978-1980	-	-	18-4075	-	18-1378	18-4040	-	-	-	18-1391	-
35	1981-1993	-	-	18-4075	18-1374	18-1378	-	-	-	18-1393	18-1391	-
40	1984-92	18-4712	-	18-4075	18-1374	18-1378	-	18-1352	-	-	18-1391	-
40	1961-70	-	-	-	-	-	18-4040	-	-	-	-	-
40	1971-73	-	-	-	-	18-1378	18-4040	-	-	-	-	-
40	1974-76	-	-	-	-	18-1378	18-4040	18-1352	-	-	18-1154	-
40	1984-86	-	-	-	18-1374	18-1378	-	18-1352	-	18-1372	18-1154	-
40	1987-97	-	-	-	18-1374	18-1378	-	18-1352	-	-	18-1154	18-1389
40	1983	-	-	18-4075	-	-	-	18-1352	-	-	18-1154	-
40 Comm	1982-83	-	-	-	-	18-1378	-	18-1352	-	-	-	-
40 Comm	1984-85	-	-	-	-	18-1378	-	18-1352	-	18-1372	-	-
40 Comm	1989-90	-	-	-	-	18-1378	-	18-1352	-	-	-	-
40 Comm	1994	-	-	-	18-1374	18-1378	-	18-1352	-	-	-	-
40 Comm	1995-97	-	-	-	18-1374	-	-	18-1352	-	-	-	-
45 Comm	1985-86	-	-	-	18-1374	18-1378	-	18-1352	-	18-1372	-	-
45 Comm	1987-94	-	-	-	18-1374	18-1378	-	18-1352	-	18-1372	-	-
45 Comm	1995-97	-	-	-	18-1374	-	-	18-1352	-	-	-	-
45 Comm	1987	-	-	-	18-1374	18-1378	-	18-1352	-	-	18-1154	-
45ss	1987-90	-	-	-	18-1374	18-1378	-	18-1352	-	18-1372	-	-
48	1987	18-4712	-	-	18-1374	18-1378	-	18-1352	-	18-1372	-	-
48	1987-92	18-4712	-	18-4075	18-1374	18-1378	-	18-1352	-	-	-	-
48	1988-96	-	-	-	18-1374	18-1378	-	18-1352	-	-	-	-
50	1979-83	18-4712	-	18-4075	18-1374	18-1378	18-4040	18-1352	-	18-1372	-	-
50	1979-86	-	-	-	18-1374	18-1378	-	18-1352	-	18-1372	-	-
50	1981-93	18-4712	-	18-4075	18-1374	18-1378	-	18-1352	-	-	-	-
50②	1987-97	-	-	-	18-1374	18-1378	-	18-1352	-	-	-	-
50③	1995-97	-	-	-	18-1374	18-1378	-	18-1352	-	-	-	-
55	1968-69	-	-	-	-	18-1378	18-4040	18-1352	-	-	-	-
55	1976-81	-	-	-	18-1374	18-1378	18-4040	18-1352	-	18-1372	-	-
55 Comm	1982	-	-	-	18-1374	18-1378	18-4040	18-1352	-	18-1372	-	-
55 Comm	1983-86	-	-	-	18-1374	18-1378	-	18-1352	-	18-1372	-	-
55 Comm	1987-94	-	-	-	18-1374	18-1378	-	18-1352	-	-	-	-
55 Comm	1995-97	-	-	-	18-1374	18-1378	-	18-1352	-	-	-	-
55	1978-93	18-4712	-	18-4075	-	-	-	-	-	-	-	-
60	1980-85	18-4712	-	18-4075	18-1374	18-1378	-	18-1352	-	18-1372	-	-
60	1964-67,70-71	-	-	-	-	18-1378	18-4040	18-1352	-	-	-	-
60	86-90	-	-	-	18-1374	18-1378	-	18-1352	-	18-1372	-	-
60	1991-93	-	-	-	18-1374	18-1378	-	18-1352	-	-	-	-
60	1994-97	-	-	-	18-1374	-	-	18-1352	-	-	-	-
SST-60	1989-90	-	-	-	18-1374	18-1378	-	18-1352	-	18-1372	-	-
3 CILINDROS												
60	1985	-	-	18-4075	18-1374	18-1378	18-4040	18-1352	-	18-1372	-	-
60	1986-90	-	-	-	18-1374	18-1378	18-4040	18-1352	-	18-1372	-	-
60	1986-88	-	-	18-4075	18-1374	18-1378	18-4040	18-1352	-	18-1372	-	-
60	1989-92	-	-	18-4075	18-1374	18-1378	18-4040	18-1352	-	-	-	-
65	1968	-	-	-	-	18-1378	18-4040	18-1352	-	-	-	-
65	1972-73	-	-	-	-	18-1378	18-4040	18-1352	-	18-1372	-	-
65 Comm	1984	-	-	-	18-1374	18-1378	18-4040	18-1352	-	18-1372	-	-
65 Comm	1985-90	-	-	-	18-1374	18-1378	18-4040	18-1352	-	18-1372	-	-
65 Comm	1991-93	-	-	-	18-1374	18-1378	18-4040	18-1352	-	-	-	-
65 Comm.	1994-97	-	-	-	18-1374	18-1378	18-4040	18-1352	-	-	-	-
65	1984-86	-	-	18-4075	18-1374	18-1378	18-4040	18-1352	-	18-1372	18-1154	-
70	1976-85	-	-	18-4075	18-1374	18-1378	18-4040	18-1352	-	18-1372	18-1154	-
70	1974-75	-	-	-	-	18-1378	18-4040	18-1352	-	18-1372	-	-
70	1976-90	-	-	-	18-1374	18-1378	18-4040	18-1352	-	18-1372	18-1154	-

① Excepto Modelos "D"

② Modelos dos cilindros

③ Modelos tres cilindros

④ Modelos 90 grados

⑤ Modelos 60 grados

⑥ Modelos motores no incluyen cojinetes superiores kits V-4, V-6 & V-8

APLICACIONES CONTINUAN EN LA SIGUIENTE PÁGINAS

H.P.	Año	Camisa	Biela	Tornillo Biela	Cojinete Agujas	Cojinete biela Completo	Cojinete biela Solo	Cojinete central Principal	Cojinete cigüeñal	Cojinete sup cigüeñal	Cojinete inf cigüeñal	Juego de Juntas
70	1976-84	-	-	18-4075	18-1374	18-1378	18-4040	18-1352	-	18-1372	18-1154	-
70	1985-90	-	-	-	18-1374	18-1378	18-4040	18-1352	-	18-1372	18-1154	-
70	1991-93	-	-	-	18-1374	18-1378	18-4040	18-1352	-	-	-	-
70	1994-97	-	-	-	18-1374	-	-	18-1352	-	-	-	-
75	1960-65	-	-	-	-	18-1378	18-4040	18-1352	-	-	-	-
75	1975	-	-	-	-	18-1378	18-4040	18-1352	-	18-1372	18-1154	-
75	1976-84	-	-	18-4075	18-1374	18-1378	18-4040	18-1352	-	18-1372	18-1154	-
75	1982-88	-	-	18-4075	18-1374	18-1378	18-4040	18-1352	-	18-1372	18-1154	-
75	1985-88	-	-	-	18-1374	18-1378	18-4040	18-1352	-	18-1372	18-1154	-
75 ⑥	1976-88	-	-	18-4075	18-1374	18-1378	18-4040	18-1352	-	18-1372	18-1154	-
V-4 CROSSFLOW												
65JET	1992-95	-	-	18-4075	18-1374	18-1361	18-4040	18-1353	18-1377	-	18-1395	18-1386
80	1966- 67	-	-	-	-	18-1378	18-4040	18-1352	-	-	-	-
80JET	1993-97	-	-	18-4075	18-1374	18-1361	18-4040	18-1353	18-1377	-	18-1395	18-1386
80JET	1992-97	-	-	-	18-1374	181361	18-4040	18-1353	18-1377	-	18-1395	18-1386
85	1968-72	-	-	-	-	18-1378	18-4040	18-1352	-	-	18-1154	-
85	1973	-	-	-	18-1374	18-1378	18-4040	18-1352	-	-	18-1395	-
85	1974-78	-	-	-	18-1374	18-1361	18-4040	18-1352	-	-	18-1395	-
85 ⑥	1979-80	-	-	18-4075	18-1374	18-1361	18-4040	18-1353	18-1377	-	18-1395	18-1386
85 ⑥	1991-95	-	-	-	18-1374	18-1361	18-4040	18-1353	18-1377	-	18-1395	18-1386
85	1979-80,92	-	-	18-4075	18-1374	18-1361	18-4040	18-1353	18-1377	-	18-1395	18-1386
85TTL	1992-95	-	-	18-4075	18-1374	18-1361	18-4040	18-1353	18-1377	-	18-1395	18-1386
88	1987-91	-	-	18-4075	18-1374	18-1361	18-4040	18-1353	18-1377	-	18-1395	18-1386
88 ⑥	1987-96	-	-	18-4075	18-1374	18-1361	18-4040	18-1353	18-1377	-	18-1395	18-1386
88	1987-92	-	-	18-4075	18-1374	18-1361	18-4040	18-1353	18-1377	-	18-1395	18-1386
88	1993	-	-	18-4075	18-1374	18-1361	18-4040	18-1353	18-1377	-	18-1395	18-1386
88	1992-96	-	-	18-4075	18-1374	18-1361	18-4040	18-1353	18-1377	-	18-1395	18-1386
90	1981-86	-	-	18-4075	18-1374	18-1361	18-4040	18-1353	18-1377	-	18-1395	18-1386
90	1986-91	-	-	18-4075	18-1374	18-1361	18-4040	18-1353	18-1377	-	18-1395	18-1386
90	1992-94	-	-	18-4075	18-1374	18-1361	18-4040	18-1353	18-1377	-	18-1395	18-1386
90 ⑥ ④	1981-97	-	-	18-4075	18-1374	18-1361	18-4040	18-1353	18-1377	-	18-1395	18-1386
90 ④	1981-97	-	-	18-4075	18-1374	18-1361	18-4040	18-1353	18-1377	-	18-1395	18-1386
90 ⑤	1995-97	-	-	18-4075	18-1374	18-1361	18-4040	18-1353	18-1377	-	18-1395	18-1386
90JET ⑥	1994-95	-	-	18-4075	18-1374	18-1361	18-4040	18-1353	18-1377	-	18-1395	18-1386
90	1981-92	-	-	18-4075	18-1374	18-1361	18-4040	18-1353	18-1377	-	18-1395	18-1386
90	1993	-	-	18-4075	18-1374	18-1361	18-4040	18-1353	18-1377	-	18-1395	18-1386
100	1966- 68	-	-	-	-	18-1378	18-4040	18-1352	-	-	18-1154	-
100	1971- 72	-	-	-	-	18-1378	18-4040	18-1352	-	-	18-1154	-
100 ⑥	1979-80	-	-	18-4075	18-1374	18-1361	18-4040	18-1353	18-1377	-	18-1395	18-1386
100	1984-85	-	-	18-4075	18-1374	18-1361	18-4040	18-1353	18-1377	-	18-1395	18-1386
100	1986-91	-	-	18-4075	18-1374	18-1361	18-4040	18-1353	18-1377	-	18-1395	18-1386
100 ⑥	1990-94	-	-	18-4075	18-1374	18-1361	18-4040	18-1353	18-1377	-	18-1395	18-1386
100 Comm ⑥	1984-97	-	-	18-4075	18-1374	18-1361	18-4040	18-1353	18-1377	-	18-1395	18-1386
100	1979-81,92	-	-	18-4075	18-1374	18-1361	18-4040	18-1353	18-1377	-	18-1395	18-1386
100	1992-97	-	-	18-4075	18-1374	18-1361	18-4040	18-1353	18-1377	-	18-1395	18-1386
100	1993	-	-	18-4075	18-1374	18-1361	18-4040	18-1353	18-1377	-	18-1395	18-1386
100 Comm	1984-87,89-92	-	-	18-4075	18-1374	18-1361	18-4040	18-1353	18-1377	-	18-1395	18-1386
100 Comm.	1993	-	-	18-4075	18-1374	18-1361	18-4040	18-1353	18-1377	-	18-1395	18-1386
110 ⑥	1986-89	-	-	18-4075	18-1374	18-1361	18-4040	18-1353	18-1377	-	18-1395	18-1386
112 ⑥	1994- 96	-	-	-	18-1374	18-1361	18-4040	18-1353	18-1377	-	18-1395	18-1386
115	1969-70	-	-	-	-	18-1378	18-4040	18-1352	-	-	18-1154	-
115	1973	-	-	18-4075	18-1374	18-1378	18-4040	18-1352	-	-	18-1395	-
115	1974-78	-	-	18-4075	18-1374	18-1361	18-4040	18-1352	-	-	18-1395	-
115 ⑥ ④	1990-97	-	-	-	18-1374	18-1361	18-4040	18-1353	18-1377	-	18-1395	18-1386
115 ⑥	1979-85	-	-	18-4075	18-1374	18-1361	18-4040	18-1353	18-1377	-	18-1395	18-1386
115	1991-92	-	-	18-4075	18-1374	18-1361	18-4040	18-1353	18-1377	-	18-1395	18-1386
115	1990-91	-	-	18-4075	18-1374	18-1361	18-4040	18-1353	18-1377	-	18-1395	18-1386
115	1993	-	-	18-4075	18-1374	18-1361	18-4040	18-1353	18-1377	-	18-1395	18-1386
115	1992-94	-	-	18-4075	18-1374	18-1361	18-4040	18-1353	18-1377	-	18-1395	18-1386
115 ④	1990-97	-	-	-	18-1374	18-1361	18-4040	18-1353	18-1377	-	-	-
115 ⑤	1995-97	-	-	-	-	18-1361	18-4040	18-1353	18-1377	-	-	-
115JET ⑥	1994-97	-	-	-	18-1374	18-1361	18-4040	18-1353	18-1377	-	18-1395	18-1386
115C	1984	-	-	18-4075	18-1374	18-1361	18-4040	18-1353	18-1377	-	18-1395	18-1386
120 ⑥	1985-94	-	-	-	18-1376	18-1360	-	18-1353	18-1377	-	18-1396	-
125	1971-72	-	-	-	-	18-1378	18-4040	18-1352	-	-	-	-
125 Comm ⑥	1989-95	-	-	-	18-1376	18-1360	-	18-1353	18-1377	-	18-1396	-
125Esx ⑥	1991-94	-	-	-	18-1376	18-1360	-	18-1353	18-1377	-	18-1396	-
130 ⑥	1994-97	-	-	-	18-1376	18-1360	-	18-1353	18-1377	-	18-1396	-
135	1973	-	-	-	18-1374	18-1378	18-4040	18-1352	-	-	18-1395	-
135	1974-76	-	-	18-4075	18-1374	18-1361	18-4040	18-1352	-	-	18-1395	-
140	1977-78	-	-	18-4075	18-1374	18-1361	18-4040	18-1352	-	-	18-1395	-
140	1979	-	-	18-4075	-	-	-	-	-	-	-	-
140 ⑥	1979-84	-	-	-	18-1374	18-1361	18-4040	18-1353	18-1377	-	18-1395	18-1386
140 ⑥	1985-94	-	-	-	18-1376	18-1360	-	18-1353	18-1377	-	18-1396	-
140	1977-84	-	-	18-4075	18-1374	18-1361	18-4040	18-1353	18-1377	-	18-1395	18-1386

① Excepto modelos "D"

② Modelos 2 cilindros

③ Modelos 3 cilindros

④ Modelos 90 grados

⑤ Modelos 60 grados





⑥ Modelos motores V-4, V-6 & V-8 no incluyen cojinetes superiores en kit

H.P.	Año	Camisa	Biela	Tornillo Biela	Cojinete Agujas	Cojinete biela. Completo	Cojinete biela. solo	Cojinete central principal.	Cojinete cigüeñal	Cojinete sup cigüeñal	cojinete inf cigüeñal	Juego de Juntas
1600CC	1988	-	-	18-4075	-	-	-	-	-	-	-	-
1.6L	-	-	-	18-4075	-	-	-	-	-	-	-	-
V-6 CROSSFLOW												
150 ⑥	1978-91	-	-	-	18-1374	18-1361	18-4040	18-1353	18-1377	-	18-1395	-
150 ⑤	1991-97	-	-	-	-	18-1361	18-4040	18-1353	-	-	-	-
150 Comm ⑤	1993-95	-	-	-	-	18-1361	18-4040	18-1353	-	-	-	-
150	1978-85	-	-	18-4075	18-1374	18-1361	18-4040	18-1353	18-1377	-	18-1395	-
150	1978-88	-	-	18-4075	18-1374	18-1361	18-4040	18-1353	18-1377	-	18-1395	-
150	1986-91	-	-	18-4075	18-1374	18-1361	18-4040	18-1353	18-1377	-	-	-
150	1989-91	-	-	18-4075	18-1374	18-1361	18-4040	18-1353	18-1377	-	-	-
155 Comm	1984-85	-	-	18-4075	18-1374	18-1361	18-4040	18-1353	18-1377	-	18-1395	-
155 Comm ⑥	1984-92	-	-	-	18-1374	18-1361	18-4040	18-1353	18-1377	-	18-1395	-
155 Comm	1986-91	-	-	18-4075	-	-	-	-	-	-	-	-
175 ⑥	1977-91	-	-	-	18-1374	18-1361	18-4040	18-1353	18-1377	-	18-1395	-
175 ⑤	1991-97	-	-	-	-	18-1361	18-4040	18-1353	-	-	-	-
175	1977-83	-	-	18-4075	18-1374	18-1361	18-4040	18-1353	18-1377	-	-	-
175	1986-90	-	-	18-4075	18-1374	18-1361	18-4040	18-1353	18-1377	-	-	-
175	1977-83,85	-	-	18-4075	18-1374	18-1361	18-4040	18-1353	18-1377	-	-	-
185 ⑥	1984-85	-	-	18-4075	18-1374	18-1361	18-4040	18-1353	18-1377	-	18-1395	18-1389
185	1990	-	18-4148-1	18-4076	-	-	-	-	-	-	-	-
185 ⑥	1990-94	-	-	-	18-1376	18-1360	-	18-1353	18-1377	-	18-1396	18-1389
185	1990-93	-	18-4148-1	18-4076	-	-	-	-	-	-	-	-
185	1992-94	-	18-4148-1	18-4076	-	-	-	-	-	-	-	-
200 ⑥	1976-83	-	-	18-4075	18-1374	18-1361	18-4040	18-1353	18-1377	-	18-1395	18-1389
200	1986-97	-	-	-	18-1376	18-1360	-	18-1353	18-1377	-	18-1396	-
200 Comm	1990	-	18-4148-1	18-4076	-	-	-	-	-	-	18-1396	-
200 Comm	1990-94	-	-	-	18-1376	18-1360	-	18-1353	18-1377	-	-	-
200	1976-83	-	-	18-4075	18-1374	18-1361	18-4040	18-1353	18-1377	-	18-1395	-
200C	1990	-	-	18-4076	18-1376	18-1360	-	18-1353	18-1377	-	18-1396	-
200	1986-91	-	-	18-4076	-	-	-	-	-	-	-	-
200	1986-93	-	-	18-4076	-	-	-	-	-	-	-	-
225 ⑥	1986-97	-	-	-	18-1376	18-1360	-	18-1353	18-1377	-	18-1396	18-1389
235 ⑥	1978-85	-	-	18-4075	18-1374	18-1361	18-4040	18-1353	18-1377	-	18-1395	-
235	1978-79	-	-	18-4075	18-1374	18-1361	18-4040	18-1353	18-1377	-	-	-
235	1980-85	18-4718	-	18-4075	18-1374	18-1361	18-4040	18-1353	18-1377	-	-	-
250	1991-95	-	-	-	18-1376	18-1360	-	18-1353	18-1377	-	18-1396	-
250	1997	-	-	-	18-1376	18-1360	-	18-1353	18-1377	-	18-1396	-
275	1985-88	-	-	-	18-1376	18-1360	-	18-1353	18-1377	-	18-1396	-
3.6L	1985-87	-	-	-	18-1376	18-1360	-	18-1353	18-1377	-	18-1396	-
300	1988-95	-	-	-	18-1376	18-1360	-	18-1353	18-1377	-	18-1396	-
2500CC	1988	-	-	-	-	-	-	-	-	-	-	-
2.5L	1982,84-85	-	-	-	-	-	-	-	-	-	-	-
2.6L	1982-86	18-4718	-	-	-	-	-	-	-	-	-	-
V-4 LOOPER												
120	1985	-	-	18-4076	18-1376	18-1360	-	18-1353	18-1377	-	18-1396	-
120	1985-94	-	-	18-4076	18-1376	18-1360	-	18-1353	18-1377	-	18-1396	-
125	1985-94	-	-	18-4076	18-1376	18-1360	-	18-1353	18-1377	-	18-1396	-
140	1985-94	-	-	18-4076	18-1376	18-1360	-	18-1353	18-1377	-	18-1396	-
1.8L	ALL	-	-	18-4076	-	-	-	-	-	-	-	-
V-6 LOOPER												
225	1986-91	-	-	18-4076	18-1376	18-1360	-	18-1353	18-1377	-	18-1396	-
225	1986-93	-	-	18-4076	18-1376	18-1360	-	18-1353	18-1377	-	18-1396	-
2.7L	1987	-	-	18-4076	-	-	-	-	-	-	-	-
275	1985-88	-	-	18-4076	18-1376	18-1360	-	18-1353	18-1377	-	18-1396	-
300	1985-95	-	-	18-4076	18-1376	18-1360	-	18-1353	18-1377	-	18-1396	-

- ① Excepto modelos "D"
- ② Modelos 2 cilindros

- ③ Modelos tres cilindros
- ④ Modelos 90 grados

- ⑤ Modelos 90 grados
- ⑥ Modelos motores V-4, V-6 & V-8 no incluyen cojinetes en los kits

<p>18-4329 KIT RETENES CIGÜEÑAL Para: 20-35 HP</p>  <table border="1" style="width: 100%; border-collapse: collapse; margin-top: 10px;"> <thead> <tr> <th>HP</th> <th>Años</th> <th>HP</th> <th>Años</th> </tr> </thead> <tbody> <tr> <td>20</td> <td>1981-89</td> <td>30</td> <td>1984-89</td> </tr> <tr> <td>25</td> <td>1977-89</td> <td>35</td> <td>1976-89</td> </tr> <tr> <td>28</td> <td>1986-88</td> <td></td> <td></td> </tr> </tbody> </table>	HP	Años	HP	Años	20	1981-89	30	1984-89	25	1977-89	35	1976-89	28	1986-88			<p>18-4330 KIT RETENES CIGÜEÑAL Para: 40-75 HP</p> 	<p>18-4331 KIT RETENES CIGÜEÑAL Para: Crossflow V-4 - V-6</p> 
HP	Años	HP	Años															
20	1981-89	30	1984-89															
25	1977-89	35	1976-89															
28	1986-88																	
<p>18-4332 KIT RETENES CIGÜEÑAL Para: 9.9 - 15 HP</p> 	<p>18-8355 KIT RETENES CIGÜEÑAL Para:</p> <table border="1" style="width: 100%; border-collapse: collapse; margin-top: 10px;"> <thead> <tr> <th>Año</th> <th>Modelo/HP</th> <th>Año</th> <th>Modelo/HP</th> </tr> </thead> <tbody> <tr> <td>1990</td> <td>20-30AC, TE, E/ 20-35R/25COMM.</td> <td>1993-96</td> <td>20-35R/25/30TE/ 20-30E</td> </tr> <tr> <td>1991-92</td> <td>25/28/32R, TE, RE</td> <td>1994-96</td> <td>20-30AC,E/ 25COMM./28</td> </tr> </tbody> </table>	Año	Modelo/HP	Año	Modelo/HP	1990	20-30AC, TE, E/ 20-35R/25COMM.	1993-96	20-35R/25/30TE/ 20-30E	1991-92	25/28/32R, TE, RE	1994-96	20-30AC,E/ 25COMM./28	<p>18-1286 RETÉN SUPERIOR Reemplaza: 336232 Para: 60° & EFI 90-115HP & 150-175HP</p> 				
Año	Modelo/HP	Año	Modelo/HP															
1990	20-30AC, TE, E/ 20-35R/25COMM.	1993-96	20-35R/25/30TE/ 20-30E															
1991-92	25/28/32R, TE, RE	1994-96	20-30AC,E/ 25COMM./28															



***18-7895**
FILTRO ACEITE
 Reemplaza: 778888, 5035703
 200/225 (2004-05)



***18-7896**
FILTRO ACEITE
 Reemplaza: 778886, 5033539
 90-115 EFI (2003-05)



***18-7897**
FILTRO ACEITE
 Reemplaza: 778887, 5033919
 140 EFI (2003-05)



18-7903
FILTRO ACEITE
 Reemplaza: 5033102, 763364
 9.9-15HP (2002-07)



***18-7915-1**
FILTRO ACEITE
 Reemplaza: 778885, 5031411
 25-70 HP (1998-2005)



***18-7916**
FILTRO ACEITE
 Reemplaza: 434839
 9.9 & 15 HP modelos desde (1995-2001)
 OMC



18-70936
MANGUITO (CABEZA DE CILINDRO, ESTRIBOR)
 Reemplaza: 340975, 321724
 Para: 90 (1994-95), 100 (1996-97), 115 (1994-97), E88 (1996), E90 (1996-98),
 E100 (1996-97), E112 (1996), E115 (1996-98), J88 (1996), J90 (1996-98), J100
 (1997-98), J112 (1996), J115 (1996-98)



18-70937
MANGUITO (CABEZA DE CILINDRO, ESTRIBOR)
 Reemplaza: 340976
 Para: 90 (1994-95), 100 (1996-97), 115 (1994-97), E88 (1996), E90 (1996-98),
 E100 (1996-97), E112 (1996), E115 (1996-98), J88 (1996), J90 (1996-98), J100
 (1997-98), J112 (1996), J115 (1996-98)

— CONTIENE —

Ref #	Desc.	O.E. #	Cant.
18-0933	Junta silenciador	314115	1
18-0935	Junta base	314322	1
18-0951	Junta carburador	317305	1
18-2543	Junta	318609	1
18-0118	Junta carburador	325092	3
18-2913	Junta tapa escape	318609	2
18-2938	Junta tapa escape	331917	1
18-2548	Junta termostato	332108	1
18-2865	Junta adaptador	313763	1
18-0929	Junta termostato	313416	1

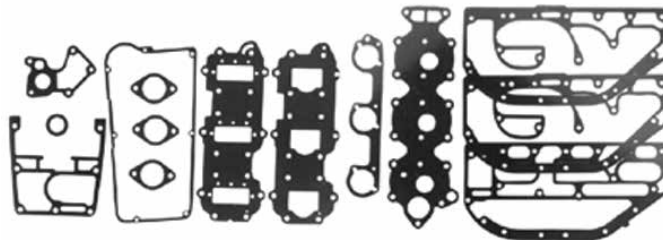

18-4300
KIT JUNTAS MOTOR
 Reemplaza: 385416, 439084

— CONTIENE —

Ref #	Desc.	O.E. #	Cant.
18-2876	Junta tapa	307133	4
18-2866	Junta tapa escape	317914	2
18-0953	Junta	317951	1
18-0117	Junta platina escape	317995	1
18-0955	Junta tapa escape	318156	1
18-2873	Junta tapa cilindro estribor	318335	2
18-0957	Junta adaptador	318373	1
18-2867	Junta colector	319174	1
18-2864	Junta adaptador	321727	1
18-0991	Junta platina	321907	4
18-0134	Junta carburador	327707	2
18-2857	Junta silenciador	386573,	
	a junta carburador	319771	2

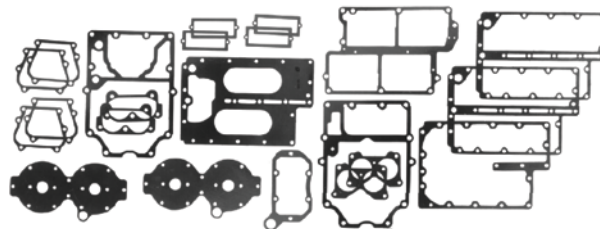

18-4301
KIT JUNTAS MOTOR
 Reemplaza: 388602

APLICACIONES COMIENZAN EN LA PÁGINA 83

* Válvula de anti-drenaje de retorno

Elimina los arranques en seco, la válvula evita que el aceite retorne al cárter durante el apagado del motor.

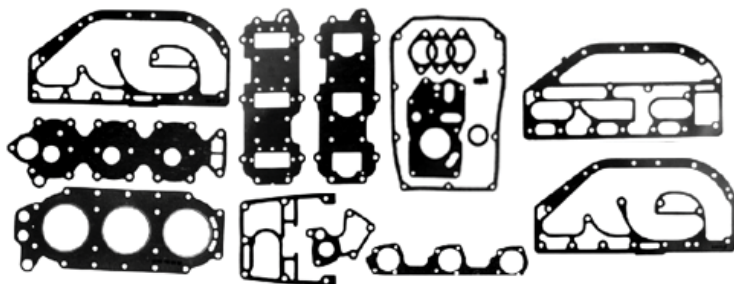

18-4302
KIT JUNTAS MOTOR
Reemplaza: 390078

- CONTIENE -			
Ref #	Desc.	O.E. #	Cant.
18-2960	Juntas culata	313413	1
18-2865	Junta adaptador	313763	1
18-0951	Junta carburador	317305	1
18-2543	Junta	318609	1
18-0989	Junta silenciador	321794	1
18-0118	Junta carburador	325092	3
18-0102	Junta colector escape	323469	1
18-2913	Junta tapa escape	331916	2
18-2938	Junta tapa escape	331917	1
18-2548	Junta tapa termostato	332108	1
18-0975	Junta carburador	333008	1

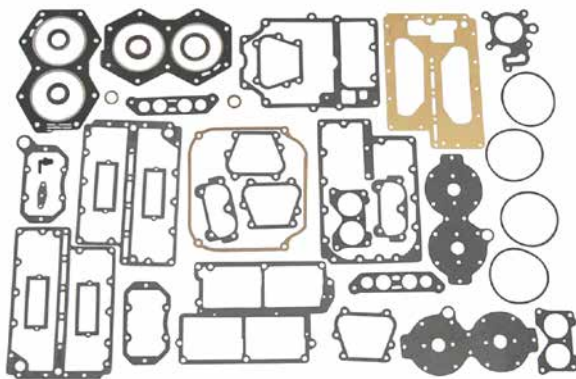

18-4303-1
KIT JUNTAS MOTOR
Reemplaza: 389556, 391300, 439085

- CONTIENE -			
Ref #	Desc.	O.E. #	Cant.
18-0850	Junta montaje bomba combustible	303615	1
18-2876	Junta tapa	307133	4
18-2866	Junta tapa escape	317914	2
18-0953	Junta	317951	1
18-0117	Junta platina escape	317995	1
18-2873	Junta	318335	2
18-2074	Retén	0339620	1
18-2956	Juntas culata	318358	2
18-2867	Junta colector	319174	1
18-2857	Junta silenciador	386573, 319771	2
18-0985	Junta silenciador	321722	1
18-2864	Junta adaptador	321727	1
18-0991	Junta platina	321907	4
18-2547	Junta tapa	322858	1
18-0102	Junta colector escape	323469	1
18-0134	Junta platina	326926	1
18-0977	Junta termostato	332369	2

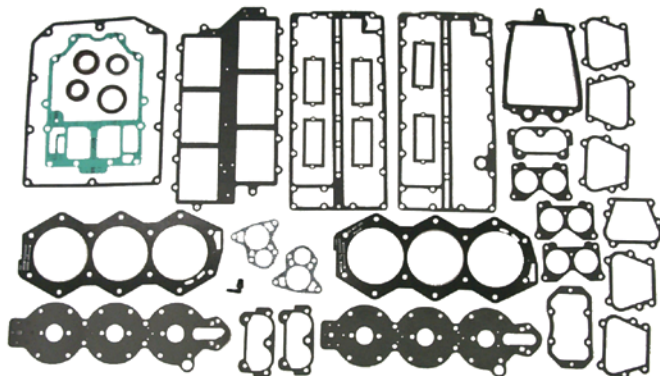

18-4304-1
KIT JUNTAS MOTOR
Reemplaza: 391988

- CONTIENE -			
Ref #	Desc.	O.E. #	Cant.
18-2549	Junta platina escape	321543	1
18-2876	Junta tapa	307133	6
18-2544	Junta tapa de escape	321028	2
18-2545	Junta platina de escape	321182	1
18-0979	Junta silenciador	321183	1
18-2546	Junta termostato	321184	2
18-0991	Junta platina	321907	6
18-2547	Junta tapa	322858	1
18-0995	Junta adaptador	323222	1
18-0134	Junta carburador	327707	3
18-0148	Junta colector	329718	1
18-2964	Junta culata	320745, 335360, 7667792	1
18-2550	Junta culata	323214	1
18-2857	Junta silenciador	386573, 319771	1
18-2001	Retén aceite	330137	1
18-2074	Retén aceite	0339620	2
18-8307	Retén aceite	331103	1



18-4305
KIT JUNTAS MOTOR
Reemplaza: 393433, 437806, 439083
Para: sólo modelos 2 cilindros

- CONTIENE -			
Ref #	Desc.	O.E. #	Cant.
18-0851	Junta	329826	1
18-0850	Junta montaje bomba combustible	303615	1
18-0941	Junta tapa	315538	1
18-0118	Junta carburador	325092	2
18-0120	Junta tapa escape	325211	1
18-0128	Junta montaje culata	326468, 351018	1
18-3802	Junta culata	327795, 335359	1
18-0136	Junta montaje culata	328283	1
18-0157	Junta	330698	1
18-0154	Junta	-	1
18-0159	Junta	330909	1
18-0983	Junta carburador	321497	1
18-0182	Junta termostato	310058	1
18-0963	Junta colector	335633	1

— CONTIENE —

Ref #	Desc.	O.E. #	Cant.
18-0850	Junta montaje bomba combustible	303615	1
18-0122	Junta platina	325260	1
18-0961	Junta carburador	318932	1
18-0967	Junta tapa	319332	1
18-0112	Junta montaje culata	324717	1
18-0959	Junta platina	318924	1
18-2907	Junta alojamiento adaptador	325721	1
18-2905	Junta tapa	329920	1
18-2853	Junta tapa escape	318925	2
18-2963	Junta culata	330818	1
18-2879	Junta filtro	331363, 3388761	

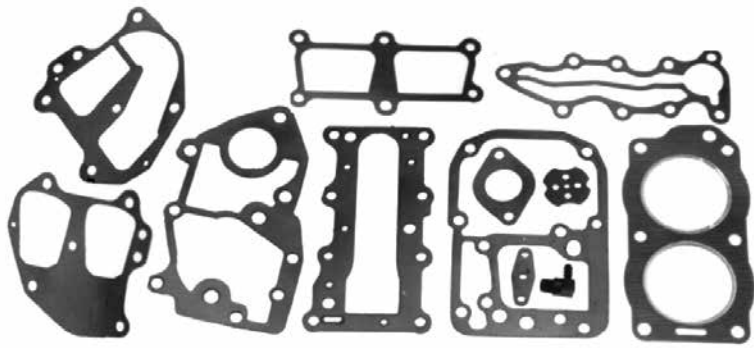

18-4306
KIT JUNTAS MOTOR
Reemplaza: 394546

— CONTIENE —

Ref #	Desc.	O.E. #	Cant.
18-0850	Junta montaje combustible	303615	1
18-0971	Junta	319661	1
18-0981	Junta platina	321479	1
18-0106	Junta colector escape	324323	2
18-0118	Junta carburador	325092	1
18-2862	Junta platina	321573, 326260	1
18-0126	Junta tapa de escape	326264	1
18-2852	Junta inferior bloque	330621	1
18-3803	Junta culata	329419, 765012	1

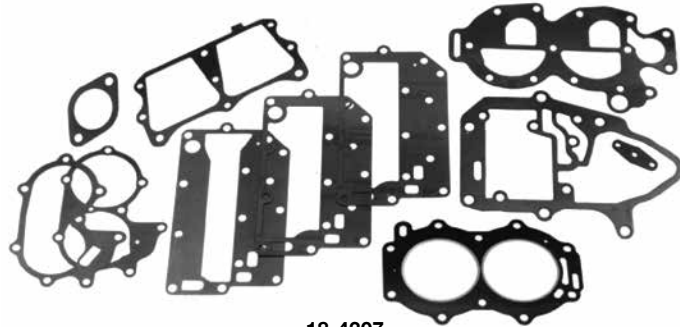

18-4307
KIT JUNTAS MOTOR
Reemplaza: 433941, 392567, 392615, 389206

— CONTIENE —

Ref #	Desc.	O.E. #	Cant.
18-0991	Junta platina	321907	6
18-0995	Junta adaptador	323222	1
18-0134	Junta carburador	327707	3
18-0148	Junta colector	329718	1
18-0979	Junta silenciador	321183	1
18-0945	Junta salida escape	336430	1
18-0927	Junta tapa escape	393561	1
18-2544	Junta tapa	321028	2
18-2546	Junta termostato	321184	2
18-2547	Junta tapa	322858	1
18-2550	Junta culata	323214	1
18-2857	Junta silenciador	386573, 319771	1
18-2876	Junta tapa	307133	6
18-7416	Aro tórico	329380	1
18-7417	Aro tórico	329381	1
18-3801	Juntas culata	325647, 335361	2

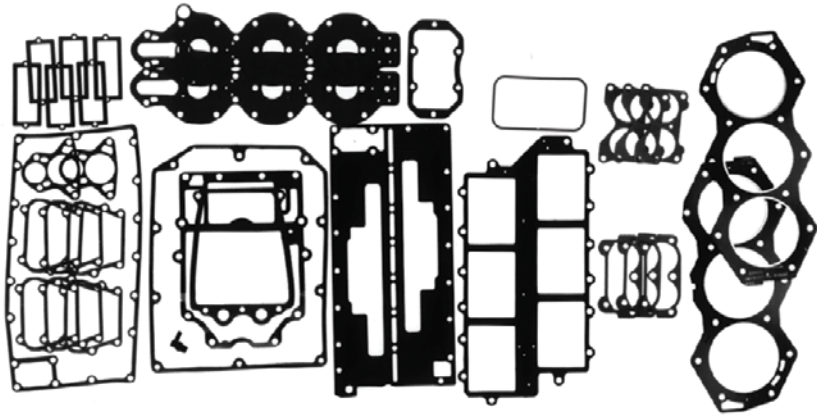

18-4309
KIT JUNTAS MOTOR
Reemplaza: 394885, 434381

— CONTIENE —

Ref #	Desc.	O.E. #	Cant.
18-0142	Junta colector	328622	1
18-0155	Junta montaje rectificador	330412	2
18-0138	Junta adaptador	328590	1
18-0140	Junta	328604	2
18-2074	Retén aceite	0339620	1
18-2075	Retén aceite	0353076	1
18-7418	Retén aceite	326741	4
18-3837	Junta culata	328623	2
18-0978	Junta tapa	331598	2

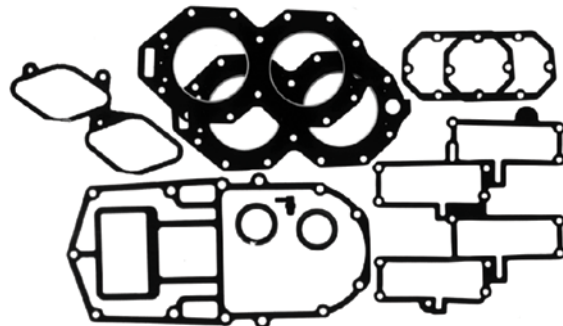

18-4310
KIT JUNTAS MOTOR
Reemplaza: 396750

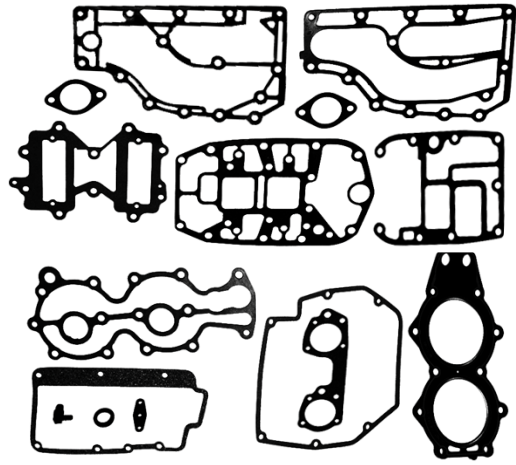

18-4318
KIT JUNTAS MOTOR
Reemplaza: 390076

— CONTIENE —

Ref #	Desc.	O.E. #	Cant.
18-0963	Junta colector	335633	1
18-0850	Junta montaje rectificador	303615	1
18-0118	Junta carburador	325092	2
18-0983	Junta carburador	321497	1
18-3802	Junta culata	327795, 335359	1
18-0941	Junta tapa	315538	1
18-0157	Junta	330698	1
18-0128	Junta montaje culata	326468, 351018	1
18-0136	Junta montaje culata	328283	1
18-1224	Junta tapa de escape	315869	1
18-1218	Junta tapa de escape	315868	1
18-0182	Retén	310058	1

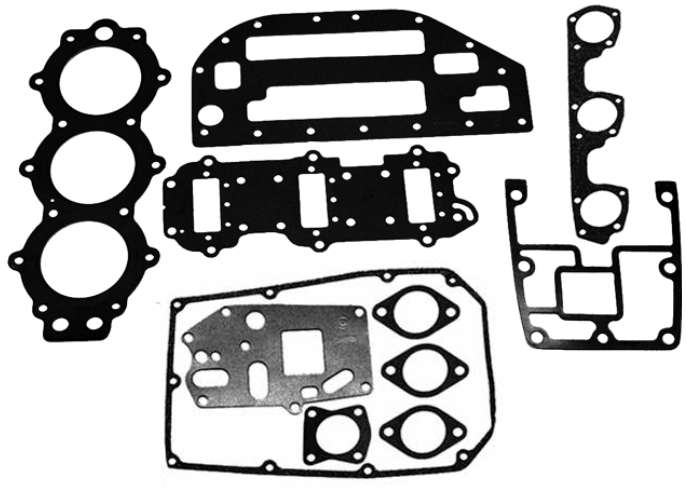

18-4321
KIT JUNTAS MOTOR
Reemplaza: 398047, 438904

— CONTIENE —

Ref #	Desc.	O.E. #	Cant.
18-0118	Junta carburador	325092	3
18-0989	Junta silenciador	321794	1
18-0975	Junta carburador	333008	1
18-3836	Junta culata	329836	1
18-1202	Junta tapa termostato	329830	1
18-1205	Junta adaptador	329828	1
18-1207	Junta colector escape	329833, 343863	1
18-1212	Junta colector	326926	1
18-1219	Casquillo	320880	1
18-1221	Junta retenedor	330273	1

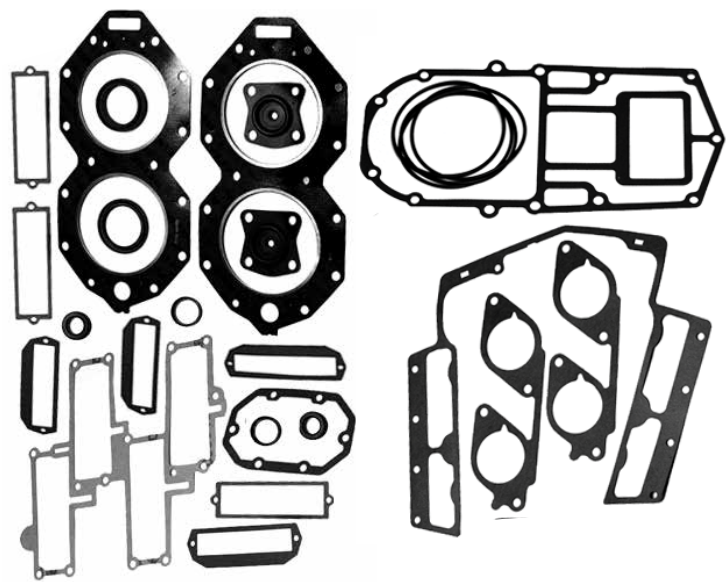

18-4322
KIT JUNTAS MOTOR
Reemplaza: 432570

— CONTIENE —

Ref #	Desc.	O.E. #	Cant.
18-0987	Junta colector	332319	2
18-0142	Junta colector	328622	1
18-2074	Retén	0339620	1
18-2075	Retén	0353076	1
18-0130	Junta caja	332266	4
18-7418	Aro tórico	326741	4
18-0155	Junta montaje rectificador	330412	1
18-3866	Junta culata	328623, 340115	2
18-0138	Junta adaptador	328590	1
18-0144	Junta caja	328626	4
18-1221	Junta retenedor	330273	2
18-1219	Casquillo	320880	2
18-1222	Junta termostato	394408	2

— CONTIENE —

Ref #	Desc.	O.E. #	Cant.
18-0130	Junta caja	332266	6
18-3839	Juntas culatas	334726, 333670	2
18-0161	Junta colector	331532	1
18-0155	Junta montaje rectificador	330412	1
18-0142	Junta colector	328622	1
18-0987	Junta colector	332319	3
18-0978	Junta tapa	331598	1
18-0965	Junta adaptador	333879	1
18-7418	Aro tórico	326741	4
18-2074	Retén	0339620	1
18-2075	Retén	0353076	2
18-1222	Junta termostato	394408	2
18-1221	Junta retenedor	330273	2
18-1219	Casquillo	320880	2
18-0412	Junta termostato	337068	2

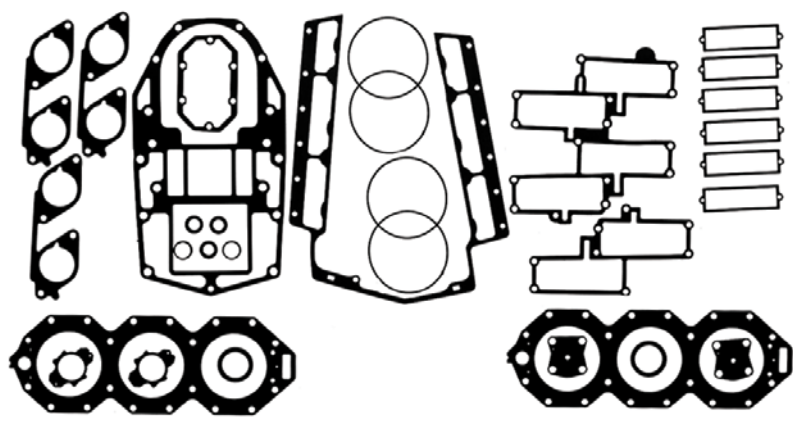

18-4323
KIT JUNTAS MOTOR
Reemplaza: 436891

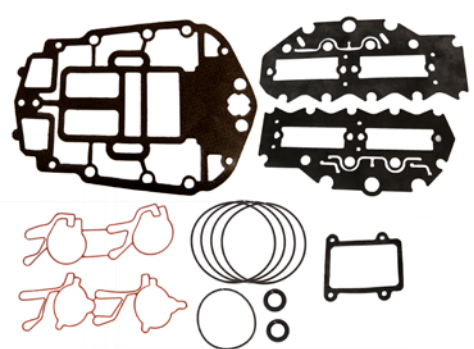

18-4402
KIT JUNTAS MOTOR
Reemplaza: 437779, 439559
Para: 90 V4 60 grados (1995-00), 115 V4 60 grados (1995-00)

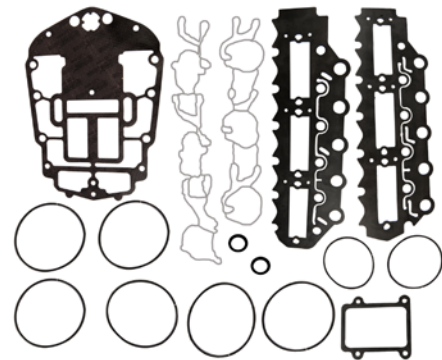

18-4406
KIT JUNTAS MOTOR
Reemplaza: 437155
Para: 150 60 grados (1991-00), 175 60 grados (1991-00)

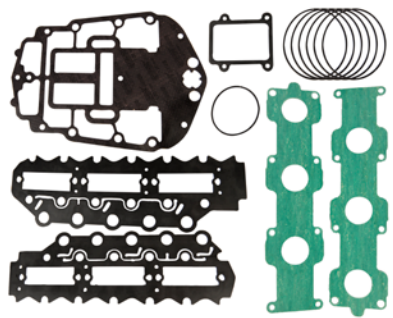

18-4420
KIT JUNTAS MOTOR
Reemplaza: 439202
Para: 150 Ficht FFI, 175 Ficht FFI

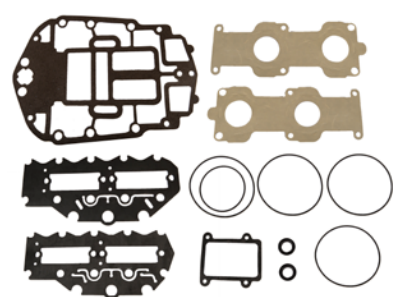

18-4421
KIT JUNTAS MOTOR
Reemplaza: 5000400
Para: 90 Ficht FFI, 115 Ficht FFI, 135 Ficht FFI

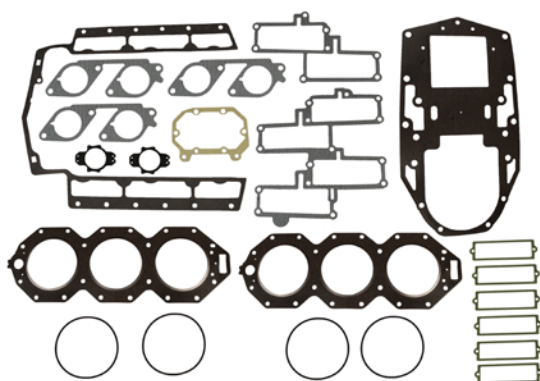

18-4428
KIT JUNTAS MOTOR
Reemplaza: 437725
Para: 200 BB (1993 & sup), 225 BB (1993 & sup), 225 Ficht FFI (1999 & sup), 250 solo Carb (2000)

APLICACIÓN EN LA SIGUIENTE PÁGINA 83

<p>Pack. de 2</p>  <p>18-2884 18-2884-9① JUNTA CULATA Reemplaza: 313782</p>	<p>Pack. de 2</p>  <p>18-2885 18-2885-9① JUNTA CULATA Reemplaza: 303438</p>	<p>Pack. de 2</p>  <p>18-2888 18-2888-9① JUNTA CULATA Reemplaza: 332010, 326953</p>
 <p>18-2950 JUNTA CULATA Reemplaza: 309612, 766870</p>	 <p>18-2951 JUNTA CULATA Reemplaza: 304720</p>	 <p>18-2952 JUNTA CULATA Reemplaza: 203034</p>
 <p>18-2954 JUNTA CULATA Reemplaza: 319633</p>	 <p>18-2956 JUNTA CULATA Reemplaza: 318358</p>	 <p>18-2957 JUNTA CULATA Reemplaza: 307069</p>
 <p>18-2958 JUNTA CULATA Reemplaza: 315539</p>	 <p>18-2959 JUNTA CULATA Reemplaza: 306048</p>	 <p>18-2960 JUNTA CULATA Reemplaza: 313413</p>
 <p>18-2961 JUNTA CULATA Reemplaza: 329103</p>	 <p>18-2962 JUNTA CULATA Reemplaza: 322332</p>	 <p>18-2963 JUNTA CULATA Reemplaza: 330818, 320533, 318914</p>

① Precio envasado

 <p>18-2964 JUNTA CULATA Reemplaza: 320745, 335360, 766779</p>	 <p>18-3800 JUNTA CULATA Reemplaza: 325273</p>	 <p>18-3801 JUNTA CULATA Reemplaza: 325647, 335361</p>
 <p>18-3802 JUNTA CULATA Reemplaza: 320658, 327795, 335359</p>	 <p>18-3803 JUNTA CULATA Reemplaza: 324324, 329419, 765012 Para: solo 2 cilindros modelos</p>	 <p>18-3836 JUNTA CULATA Reemplaza: 329836</p>
 <p>18-3837 JUNTA CULATA Reemplaza: 328623</p>	 <p>18-3838 JUNTA CULATA Reemplaza: 331211</p>	 <p>18-3839 JUNTA CULATA Reemplaza: 333670, 334726</p>
 <p>18-3841-2 JUNTA CULATA Reemplaza: 203130</p>	 <p>18-3898 JUNTA CULATA Reemplaza: 332819</p>	 <p>18-3866 JUNTA CULATA Reemplaza: 340115, 333549 Para: V-4 Loop Charge</p>
 <p>18-3895 JUNTA CULATA Reemplaza: 332816</p>	 <p>18-3896 JUNTA CULATA Reemplaza: 332817</p>	 <p>18-0491 JUNTA CULATA Reemplaza: 346007 Para: 200 Ficht FFI (1999-01), 225 (2000-04), 250 (2000-04), 3.3L (2000-04)</p>
 <p>18-0492 JUNTA CULATA Reemplaza: 340919, 345257 Para: 200 BB (1993 & sup), 225 BB (1993 & sup), 225 Ficht FFI (1999 & sup) 250 Carb solo (2000)</p>	<p>PACK. DE 12</p>  <p>18-7110 18-7110-9① ARO TÓRICO Reemplaza: 335523 3.960 D.E x 0.103 H Para: 90/115 HP (1995-98), 100 HP (1998), 105 HP (1997-98), 150/175 HP (1991-97) 90 Ficht FFI, 115 Ficht FFI, 135 Ficht FFI, 150 Ficht FFI, 175 Ficht FFI, 90 V4 60 grados(1995-00), 115 V4 60 grados (1995-00), 150 60 grados(1991-00), 175 60 grados (1991-00)</p>	

① Precio envasado

JUNTA CULATA/APLICACIÓN JUEGO JUNTAS

HP	Año	Junta Culata	Junta culata inferior	Juego de juntas	HP	Año	Junta Culata	Junta culata inferior	Juego de Juntas
1.5	1968-70	18-2884	—	—	65 Comm.	1987-95	18-3836	—	18-4321
2, Colt, Jr.	1971-90	18-2884	—	—	65 Jet	1991-95	18-2956 ①	18-3898 ①	18-4303-1
2.5,3,4,4.5, Ultra, Excel 4	1981-93	18-2888	—	—	70	1974-76	18-2960	18-3895	18-4300 ⑨
3	1957-68	18-3841-2	—	—	70	1977-85	18-2960	18-3895	18-4302
4	1969-80	18-3841-2	—	—	70	1986-97	18-3836	—	18-4321
4.5	1980	18-3841-2	—	—	75	1960-65	18-2959 ①	—	—
5	1965-68	18-2961	—	—	75	1975	18-2960	18-3895	18-4300 ⑨
5	1984-95	18-3800	—	—	75	1977-88	18-2960	18-3895	18-4302
5.5	1957-58	18-2885	—	—	80	1966-67	18-2959 ①	—	—
5.5	1959-64	18-2961	—	—	80 Jet	1991-96	18-2956 ①	18-2956 ①	18-4303-1
6	1965-79	18-2961	—	—	85	1968-72	18-2959 ①	—	—
6	1984-95	18-3800	—	—	85	1979-80,91-95	18-2956 ①	18-3898 ①	18-4303-1
6.5 Comm.	1989-90	18-3800	—	—	88	1987-95	18-2956 ①	18-3898 ①	18-4303-1
7.5	1957-58	18-2952	—	—	90	1964-65	18-2959 ①	—	—
7.5	1980-93	18-3800	—	—	90	1981-95	18-2956 ①	18-3898 ①	18-4303-1
8	1984-95	18-3800	—	—	100	1966-72	18-2959 ①	—	—
9.5	1964-73	18-2950	—	—	100 ③	1979-95	18-2956 ①	18-3898 ①	18-4303-1
9.9	1974-92	18-2963	—	18-4306 ②	1600CC	1988	18-2956 ①	18-3898 ①	18-4303-1
10 Comm.	1989-90	18-2963	—	18-4306	110	1986-89	18-2956 ①	18-3898 ①	18-4303-1
14	1988-90	18-2963	—	18-4306	115	1969-70	18-2959 ①	—	—
15	1974-92	18-2963	—	18-4306 ④	115	1973-77	18-2956 ①	18-3898 ①	—
18	1959-73	18-2962	—	—	115	1978-95	18-2956 ①	18-3898 ①	18-4303-1
18 Jet	1995-98	18-3803	—	18-4307	120	1985-87	18-3837 ①	—	18-4310
20	1981-99	18-3803	—	18-4307	120	1988-94	18-3866 ①	—	18-4322
25	1969-76	18-2962	—	—	125 Comm.	1992-95	18-3866 ①	—	18-4322
25	1977-78	18-2954	—	—	130	1995-98	18-3866 ①	—	18-4322
25 ⑤	1979-03	18-3803	—	18-4307	135	1973-76	18-2956 ①	18-3898 ①	18-4301
28	1986-96	18-3803	—	18-4307	140	1977	18-2956 ①	18-3898 ①	18-4301
30 ⑤	1984-03	18-3803	—	18-4307	140	1978-84	18-2956 ①	18-3898 ①	18-4303-1
33	1965-70	18-2951	—	—	140	1985-87	18-3837 ①	—	18-4310
35	1957-58	18-2951	—	—	140	1988-94	18-3866 ①	—	18-4322
35	1976-78	18-2954	—	—	150	1973-91	18-2964 ①	18-3896 ①	18-4304-1
35	1979-88	18-3803	—	18-4307	155 Comm.	1984-92	18-2964 ①	18-3896 ①	18-4304-1
35 ⑥	1987	18-3802	—	18-4305	2500CC	1988	18-2964 ①	18-3896 ①	18-4304-1
40	1960-80	18-2957	—	—	175	1977-83	18-2964 ①	18-3896 ①	18-4304-1
40 Comm.	1981-90	18-2957	—	18-4324	175	1986-91	18-3801 ①	18-3897 ①	18-4309
40	1984-97	18-3802	—	18-4305	185	1984-85	18-2964 ①	18-3896 ①	18-4304-1
40 Comm.	1994-97	18-3802	—	18-4305	185	1990-93	18-3839 ①	—	18-4323
45 Comm.	1985-97	18-3802	—	18-4305	200	1976-83	18-2964 ①	18-3896 ①	18-4304-1
45SS	1987-90	18-3802	—	—	200	1986-87	18-3838 ①	—	—
48	1987-97	18-3802	—	18-4305	200 ③	1988-93	18-3839 ①	—	18-4323
50	1958-59	—	—	—	225	1986-87	18-3838 ①	—	—
50	1971-75	18-2958	—	18-4305 ⑦	225	1988-93	18-3839 ①	—	18-4323
50	1979-80	18-3802	—	18-4318	235	1978-79	18-2964 ①	18-3896 ①	—
50	1981-97	18-3802	—	18-4305	235	1980-85	18-3801 ①	18-3897 ①	18-4309
55	1968-69	18-2960	18-3895	—	275/3.6L	1985-87	18-3840 ①	—	—
55	1977-79	18-3802	—	18-4318	OMC SEA DRIVE				
55	1980-97	18-3802	—	18-4305	HP	Año	Junta Culata	Junta culata inferior	Juego de juntas
55	1995	18-3802	—	—	1.6L	1983-90	18-2956	18-3898 ①	18-4303-1
60	1970-71	18-2960	18-3895	—	1.8L	1987	18-3837	-	-
60	1980-85	18-3802	—	18-4305	2.0L	1988-90	18-3866 ①	-	18-4322
60	1986-88	18-2960	18-3895	18-4302	2.5L	1982,84-85	18-2964	18-3896 ①	18-4304-1
60	1989-97	18-3836	—	18-4321	2.6L	1982-86	18-3801 ①	18-3897 ①	-
SST60	1989-90	18-3836	—	—	2.7L	1987	18-3838	-	-
65	1968	—	—	—	3.0L	1988-90	18-3839	-	-
65	1972-73	18-2960	18-3895	18-4300 ⑨	3.6L	1987	18-3840	-	-
65 Comm.	1984-86	18-2960	—	18-4302					

① Requiere dos juntas culata por motor

② Sólo modelos con sufijo G y H 1976

③ También modelos comerciales

④ Sólo modelos con sufijo 1976 A











⑤ Sólo para modelos 2 cilindros





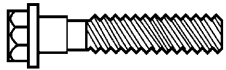







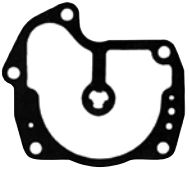

⑥ Sólo modelos con sufijo D

⑦ Se requiere junta culata 18-29585 para completar el juego





















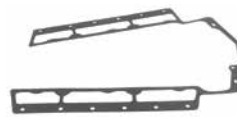
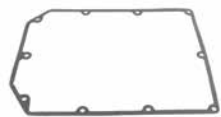

⑨ Junta culata no disponible en el juego de juntas

TORNILLOS ACERO INOXIDABLE

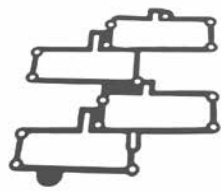















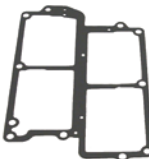
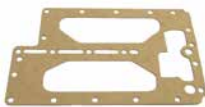
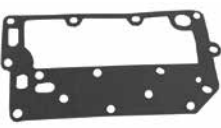
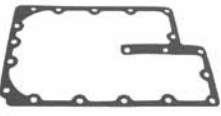

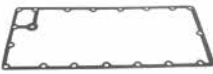

 <p>18-3133 Reemplaza: 331979 1/4" x 20 x 1 1/16" HEXAGONAL Para: motores arranque, alojamientos bomba de agua y unidades jet-drive</p>	<p>Pack. de 2</p>  <p>18-3135 18-3135-9① Reemplaza: 306643 1/8" x 20 x 1/2" RANURA Para: Ánodos para partes inferiores, tapas encendido y alojamiento bombas de agua</p>	<p>Pack. de 2</p>  <p>18-3136 18-3136-9① Reemplaza: 323626 1/4" x 20 x 1 3/4" HEXAGONAL CON BASE PLANA Para: Alojamiento bombas de agua, tapas escape, colectores, bobinas de encendido</p>	 <p>18-3153 Reemplaza: 908158 1/4" x 20 x 1/2" HEX Para: Ánodos parte inferior soporte cojinetes. Tapas 45 HP y superiores cobra, tapa motor inferior 5 HP</p>
 <p>18-3365 Reemplaza: 909533 1/4" x 20 x 1" HEXAGONAL CON BASE PLANA Para: Tapas volante e interiores y mas</p>	 <p>18-3369 Reemplaza: 302325 1/4" x 20 x 1" HEXAGONAL Para: Impulsor alojamiento, bobina encendido, tapa escape, abrazaderas de starter</p>	<p>Pack. de 5</p>  <p>18-4276 18-4276-9① Reemplaza: 324334 1/4" x 20 x 1 1/32" HEXAGONAL BASE PLANA Para: bomba agua, tapa escape, bobinas de encendido, colectores</p>	<p>TIPO CABEZA</p>  <p>HEXAGONAL C/ BASE PLANA</p>  <p>HEXAGONAL</p>  <p>RANURA</p>  <p>FILLISTER</p>

<p>Pack. de 2</p>  <p>18-0118 18-0118-9① JUNTA CARBURADOR Reemplaza: 325092</p>	<p>Pack. de 2</p>  <p>18-0134 18-0134-9① V-4 & V-6 JUNTA CARBURADOR Reemplaza: 327707</p>	<p>Pack. de 2</p>  <p>18-0961 18-0961-9① JUNTA MONTAJE CARBURADOR Reemplaza: 318932</p>	 <p>18-0437 JUNTA TAPA Reemplaza: 334353</p>	 <p>18-0626 JUNTA TAPA Reemplaza: 334043</p>
 <p>18-1241 JUNTA TAZA FLOTADOR Y AGUJA</p>	 <p>18-2579 JUNTA FLOTADOR Reemplaza: 338882</p>	 <p>18-2582 JUNTA CARBURADOR Reemplaza: 338813</p>	 <p>18-8352 JUNTA CARBURADOR Reemplaza: 332253</p>	<p>Pack. de 2</p>  <p>18-2890 18-2890-9① JUNTA FLOTADOR Reemplaza: 331203, 338886, 302994</p>
<p>Pack. de 2</p>  <p>18-2893 18-2893-9① JUNTA FLOTADOR Reemplaza: 303750</p>	<p>Pack. de 2</p>  <p>18-2903 18-2903-9① JUNTA FLOTADOR Reemplaza: 332696, 338880</p>	<p>Pack. de 2</p>  <p>18-2906 18-2906-9① JUNTA FLOTADOR Reemplaza: 333418, 333884, 338884 V-4, V-6</p>	<p>Pack. de 2</p>  <p>18-2908 18-2908-9① JUNTA FLOTADOR Reemplaza: 331499, 338878</p>	<p>Pack. de 2</p>  <p>18-0850 18-0850-9① JUNTA BOMBA COMBUSTIBLE Reemplaza: 303615</p>





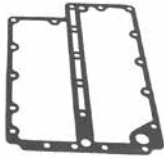





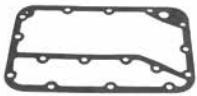

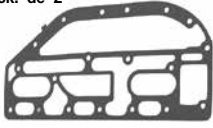



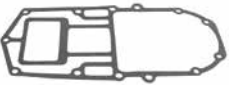

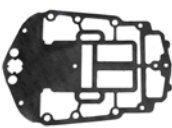
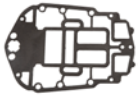

① Precio por pack

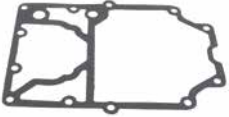

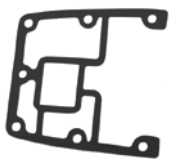
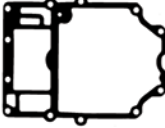

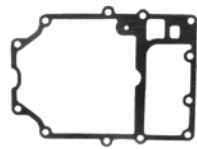



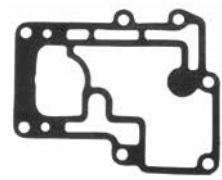
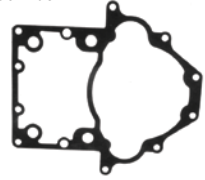
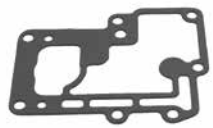

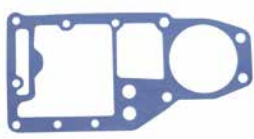









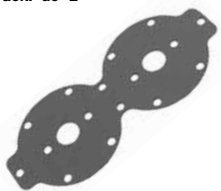

<p>Pack. de 2</p>  <p>18-2879 18-2879-9① JUNTA BOMBA COM-BUSTIBLE Reemplaza: 331363, 338876, 312634</p>	<p>Pack. de 2</p>  <p>18-2900 18-2900-9① JUNTA BOMBA COM-BUSTIBLE Reemplaza: 332694, 338879, 312679</p>	<p>Pack. de 2</p>  <p>18-2889 18-2889-9① JUNTA FILTRO Reemplaza: 302675</p>	<p>Pack. de 2</p>  <p>18-2892 18-2892-9① JUNTA FILTRO Reemplaza: 303355</p>	 <p>18-0140 JUNTA Reemplaza: 328604</p>
 <p>18-0157 JUNTA Reemplaza: 330698</p>	 <p>18-0159 JUNTA Reemplaza: 330909</p>	 <p>18-0933 JUNTA Reemplaza: 314115 70/75 HP</p>	 <p>18-0935 JUNTA BASE Reemplaza: 314322 70/75 HP</p>	<p>Pack. de 2</p>  <p>18-0975 18-0975-9① JUNTA CARBURADOR Reemplaza: 333008 3 Cil.</p>
 <p>18-0978 JUNTA A TAPA Reemplaza: 331598 Para: 185, 200 & 225 H.P., V-6</p>	 <p>18-0979 JUNTA SILENCIADOR Reemplaza: 321183 V-6</p>	<p>Pack. de 2</p>  <p>18-0983 18-0983-9① JUNTA Reemplaza: 321497</p>	 <p>18-0985 JUNTA SILENCIADOR Reemplaza: 321722 V-4</p>	 <p>18-0989 JUNTA SILENCIADOR Reemplaza: 321794 3 Cil.</p>
<p>Pack. de 2</p>  <p>18-2857 18-2857-9① JUNTA SILENCIADOR Reemplaza: 386573, 319771</p>	<p>Pack. de 2</p>  <p>18-0122 18-0122-9① 9.9 & 15 HP JUNTA Reemplaza: 325260</p>	<p>Pack. de 2</p>  <p>18-0130 18-0130-9① JUNTA CAJA Reemplaza: 332266 Para: V-4, V-6 & V-8</p>	 <p>18-0142 JUNTA COLECTOR Reemplaza: 328622</p>	<p>Pack. de 2</p>  <p>18-0144 18-0144-9① JUNTA CAJA Reemplaza: 328626 Para: 120-140 H.P V-4</p>
 <p>18-0148 JUNTA COLECTOR Reemplaza: 329718 V-6</p>	 <p>18-0161 JUNTA COLECTOR INFERIOR Reemplaza: 331532 Para: V-6</p>	 <p>18-0951 JUNTA Reemplaza: 317305 3 Cil.</p>	<p>Pack. de 2</p>  <p>18-0959 18-0959-9① JUNTA PLATINA Reemplaza: 318924 9.9 & 15 HP</p>	<p>Pack. de 2</p>  <p>18-0963 18-0963-9① JUNTA COLECTOR DOBLE Reemplaza: 335633</p>

① Precio por pack











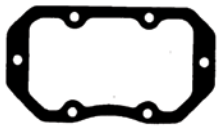









<p>Pack. de 2</p>  <p>18-0981 18-0981-9^① JUNTA PLATINA Reemplaza: 321479 25 & 35 HP</p>	<p>Pack. de 2</p>  <p>18-0987 18-0987-9^① JUNTA CUERPO DE ACELERACIÓN Reemplaza: 332319</p>	<p>Pack. de 2</p>  <p>18-0991 18-0991-9^① JUNTA PLATINA Reemplaza: 321907 V-4/V-6</p>	<p>Pack. de 2</p>  <p>18-0973 18-0973-9^① JUNTA CARBURADOR Reemplaza: 315052 V-4 Incluye montaje carburador: 100, 115, 125, 135, 140, 150, 175, 200, 235(1977-79), 85 (1969-79)</p>	
 <p>18-1212 JUNTA COLECTOR Reemplaza: 326926 Para: 3 cil.</p>	<p>Pack. de 2</p>  <p>18-2862 18-2862-9^① JUNTA PLATINA Reemplaza: 321573, 326260 25/35 HP</p>	<p>Pack. de 2</p>  <p>18-2867 18-2867-9^① JUNTA COLECTOR Reemplaza: 319174 Para: V-4</p>	<p>Pack. de 2</p>  <p>18-0102 JUNTA COLECTOR ESCAPE Reemplaza: 323469 V-4</p>	<p>Pack. de 2</p>  <p>18-0106 18-0106-9^① JUNTA COLECTOR ESCAPE Reemplaza: 324323 25/35</p>
 <p>18-0117 JUNTA PLATINA ESCAPE Reemplaza: 317955 V-4</p>	 <p>18-0120 JUNTA PLATINA ESCAPE Reemplaza: 325211</p>	<p>Pack. de 2</p>  <p>18-0126 18-0126-9^① JUNTA TAPA ESCAPE Reemplaza: 326264</p>	 <p>18-0927 JUNTA TAPA ESCAPE 235 HP Reemplaza: 393561</p>	<p>Pack. de 2</p>  <p>18-0999-9^① JUNTA ESCAPE Reemplaza: 323459 V-4</p>
 <p>18-0945 JUNTA ESCAPE EXTERIOR Reemplaza: 336430, 323217</p>	 <p>18-0955 JUNTA TAPA ESCAPE Reemplaza: 318156 V-4</p>	 <p>18-1207 JUNTA COLECTOR ESCAPE Reemplaza: 329833, 343863</p>	 <p>18-1218 JUNTA TAPA ESCAPE Reemplaza: 315868</p>	 <p>18-1224 JUNTA TAPA ESCAPE Reemplaza: 315869</p>
<p>Pack. de 2</p>  <p>18-2545 18-2545-9^① JUNTA PLATINA ESCAPE Reemplaza: 321182 V-6</p>	<p>Pack. de 2</p>  <p>18-2549 18-2549-9^① JUNTA TAPA ESCAPE Reemplaza: 321435 V-6</p>	<p>Pack. de 2</p>  <p>18-2853 18-2853-9^① JUNTA TAPA ESCAPE Reemplaza: 318925 9.9/15 HP</p>	<p>Pack. de 2</p>  <p>18-2866 18-2866-9^① JUNTA TAPA ESCAPE Reemplaza: 317914 V-4</p>	<p>Pack. de 2</p>  <p>18-2870 18-2870-9^① JUNTA TAPA ESCAPE Reemplaza: 305176</p>

① Precio por pack

<p>Pack. de 2</p>  <p>18-2871 18-2871-9① JUNTA TAPA ESCAPE Reemplaza: 304762</p>	<p>Pack. de 2</p>  <p>18-2886 18-2886-9① JUNTA TAPA ESCAPE Reemplaza: 203171</p>	<p>Pack. de 2</p>  <p>18-2913 18-2913-9① JUNTA TAPA ESCAPE Reemplaza: 331916, 319097 3 Cil.</p>	<p>Pack. de 2</p>  <p>18-2938 18-2938-9① JUNTA TAPA ESCAPE Reemplaza: 331917 3 Cil.</p>	 <p>18-1285 JUNTA ENTRADA BABOR Reemplaza: 335403 Para: V6 60° Eagle series 150-175HP (1991-00)</p>
 <p>18-0112 JUNTA BASE MOTOR Reemplaza: 324717 9.9 & 15 HP</p>	 <p>18-0128 JUNTA BASE MOTOR Reemplaza: 326468, 351018</p>	 <p>18-0136 JUNTA BASE MOTOR Reemplaza: 328283</p>	 <p>18-0138 JUNTA BASE MOTOR Reemplaza: 328590</p>	 <p>18-0690 JUNTA BASE Reemplaza: 347205 Para: 200 BB (1993 & sup), 200 Ficht FFI (1999-01), 225 BB (1993 & sup), 225 Ficht FFI (1999 & sup), 225 (2000-04), 250 sólo Carb (2000), 250 (2000-04), 3.3L (2000-04)</p>
 <p>18-0691 JUNTA BASE Para: 150 Ficht FFI, 175 Ficht FFI</p>	 <p>18-0692 JUNTA BASE Reemplaza: 339601 Para: 90 V4 60 grados (1995-00), 90 Ficht FFI, 1150V4 60 grados (1995-00), 115 Ficht FFI, 135 Ficht FFI, 150 60 grados (1991-00), 175 60 grados (1991-00)</p>	 <p>18-0693 JUNTA ADMISIÓN Reemplaza: 336227 Para: 135(2005-06), 150(1991-98), 150(1991-06), 175(1991-06)</p>	 <p>18-0694 JUNTA ADMISIÓN Reemplaza: 336226 Para: 135(2005-06), 150(1991-05), 175(1991-05)</p>	 <p>18-0695 JUNTA ADMISIÓN Reemplaza: 336389 Para: 90(1995-06), 115(1995-06), 100(1998-01, 2005)</p>
 <p>18-0696 JUNTA ADMISIÓN Reemplaza: 336388 Para: 90(1995-06), 100(1998-01, 2005), 115(1995-06)</p>	 <p>18-0957 JUNTA BASE MOTOR Reemplaza: 318373</p>	 <p>18-0965 JUNTA Reemplaza: 333879</p>	 <p>18-0995 JUNTA BASE MOTOR Reemplaza: 323222 V-6</p>	<p>Pack. de 2</p>  <p>18-1205 18-1205-9① JUNTA TAPA Reemplaza: 329828</p>
<p>Pack. de 2</p>  <p>18-2550 18-2550-9① JUNTA BASE MOTOR Reemplaza: 323214 V-6</p>	<p>Pack. de 2</p>  <p>18-2852 18-2852-9① JUNTA BASE MOTOR Reemplaza: 330621 25/35 HP</p>	<p>Pack. de 2</p>  <p>18-2864 18-2864-9① JUNTA BASE MOTOR Reemplaza: 321727 V-4</p>	<p>Pack. de 2</p>  <p>18-2865 18-2865-9① JUNTA BASE MOTOR Reemplaza: 313763 3 Cil.</p>	<p>Pack. de 2</p>  <p>18-2868 18-2868-9① JUNTA BASE MOTOR Reemplaza: 310137 35/40 HP</p>
<p>Pack. de 2</p>  <p>18-2877 18-2877-9① JUNTA Reemplaza: 314421 18/25 HP</p>	<p>Pack. de 2</p>  <p>18-2878 18-2878-9① JUNTA Reemplaza: 319710 25/35</p>	<p>Pack. de 2</p>  <p>18-2894 18-2894-9① JUNTA ALOJAMIENTO ESCAPE Reemplaza: 304314</p>	<p>Pack. de 2</p>  <p>18-2898 18-2898-9① JUNTA ALOJAMIENTO ESCAPE Reemplaza: 309956 V-4</p>	<p>Pack. de 2</p>  <p>18-2901 18-2901-9① JUNTA ALOJAMIENTO ESCAPE Reemplaza: 313065, 306205 5, 5.5, 6 HP</p>

<p>Pack. de 2</p>  <p>18-2904 18-2904-9 ① JUNTA PLATINA ESCAPE Reemplaza: 319348 28, 33, 40 HP</p>	<p>Pack. de 2</p>  <p>18-2907 18-2907-9 ① JUNTA ALOJAMIENTO ESCAPE Reemplaza: 325721</p>	<p>Pack. de 2</p>  <p>18-0967 18-0967-9 ① JUNTA Reemplaza: 319332 9.9 & 15 HP</p>	 <p>18-0971 JUNTA Reemplaza: 319661 25 & 35 HP</p>	
<p>Pack. de 2</p>  <p>18-2876 18-2876-9 ① BYPASS COVER GASKET Reemplaza: 307133</p>	<p>Pack. de 2</p>  <p>18-0941 JUNTA Reemplaza: 315538 50/55 HP</p>	<p>Pack. de 2</p>  <p>18-2543 18-2543-9 ① JUNTA Reemplaza: 318609 3 Cil.</p>	 <p>18-0892 MANGUERA Reemplaza: 322411</p>	<p>Pack. de 2</p>  <p>18-2544 18-2544-9 ① JUNTA Reemplaza: 321028 V-6</p>
<p>Pack. de 2</p>  <p>18-2856 18-2856-9 ① JUNTA Reemplaza: 319665 25/35 HP</p>	<p>Pack. de 2</p>  <p>18-3899 JUNTA TAPA AGUA Reemplaza: 327674 Para: 20, 25, 25C, 30, 35</p>	<p>Pack. de 2</p>  <p>18-2872 18-2872-9 ① JUNTA CILINDRO BABOR Reemplaza: 307257, 318334 V-4</p>	<p>Pack. de 2</p>  <p>18-2873 18-2873-9 ① JUNTA Reemplaza: 318335 V-4</p>	<p>Pack. de 2</p>  <p>18-2905 18-2905-9 ① JUNTA TAPA AGUA Reemplaza: 329920 9.9, 15 HP</p>
 <p>18-3360 JUNTA ALOJAMIENTO IMPULSOR Reemplaza: 329390 20-25 HP</p>	<p>Pack. de 2</p>  <p>18-0182 18-0182-9 ① JUNTA TERMOSTATO Reemplaza: 310058</p>	 <p>18-0397 JUNTA TERMOSTATO Reemplaza: 318917</p>	<p>Pack. de 2</p>  <p>18-0412 18-0412-9 ① JUNTA TERMOSTATO Reemplaza: 337068</p>	 <p>18-0426 JUNTA TERMOSTATO Reemplaza: 305196</p>
<p>Pack. de 2</p>  <p>18-0441 18-0441-9 ① JUNTA TERMOSTATO Reemplaza: 329076</p>	<p>Pack. de 2</p>  <p>18-0929 18-0929-9 ① JUNTA TERMOSTATO Reemplaza: 313416 3 Cil.</p>	 <p>18-0675 JUNTA TERMOSTATO Reemplaza: 321932 V-4</p>	<p>Pack. de 2</p>  <p>18-0977 18-0977-9 ① JUNTA TERMOSTATO Reemplaza: 332369 V-4</p>	<p>Pack. de 2</p>  <p>18-1202 18-1202-9 ① JUNTA TERMOSTATO Reemplaza: 329830</p>

① Precio por pack

 <p>18-1222 JUNTA TERMOSTATO Reemplaza: 394408</p>	<p>Pack. de 2</p>  <p>18-2547 18-2547-9 ① JUNTA PASO DE AGUA Reemplaza: 322858 V-4/V-6</p>	<p>Pack. de 2</p>  <p>18-2548 18-2548-9 ① JUNTA TERMOSTATO Reemplaza: 332108 3 Cil.</p>	<p>Pack. de 2</p>  <p>18-2546 18-2546-9 ① JUNTA TERMOSTATO Reemplaza: 321184 V-6</p>	<p>Pack. de 2</p>  <p>18-0124 18-0124-9 ① JUNTA IMPULSOR PLATINA Reemplaza: 325537</p>
<p>Pack. de 2</p>  <p>18-0445 18-0445-9 ① JUNTA BOMBA AGUA Reemplaza: 323312 35HP</p>	<p>Pack. de 2</p>  <p>18-0446 JUNTA BOMBA AGUA Reemplaza: 323311 35HP</p>	<p>Pack. de 2</p>  <p>18-0969 18-0969-9 ① JUNTA ALOJAMIENTO IMPULSOR Reemplaza: 319586</p>	<p>Pack. de 5</p>  <p>18-2536 18-2536-9 ① RETÉN ALOJAMIENTO IMPULSOR Reemplaza: 321120 V-4, V-6</p>	<p>Pack. de 5</p>  <p>18-2539 18-2539-9 ① RETÉN GOMA Reemplaza: 328753</p>
<p>Pack. de 2</p>  <p>18-2557 18-2557-9 ① JUNTA IMPULSOR Reemplaza: 324701, 338484 V-4, V-6, V-8</p>	<p>Pack. de 2</p>  <p>18-2709 18-2709-9 ① JUNTA PLATINA DESGASTE Reemplaza: 336530</p>	<p>Pack. de 2</p>  <p>18-0679 JUNTA TERMOSTATO Reemplaza: 311145</p>	<p>Pack. de 2</p>  <p>18-7428 18-7428-9 ① ARO TÓRICO Reemplaza: 307103</p>	<p>Pack. de 2</p>  <p>18-7481 18-7481-9 ① ARO TÓRICO Reemplaza: 324981</p>
<p>Pack. de 2</p>  <p>18-0155 18-0155-9 ① JUNTA MONTAJE RECTI- FICADOR Reemplaza: 330412</p>	<p>Pack. de 2</p>  <p>18-0851 18-0851-9 ① JUNTA Reemplaza: 329826</p>	<p>Pack. de 2</p>  <p>18-0953 18-0953-9 ① JUNTA Reemplaza: 317951 V-4/V-6</p>	<p>Pack. de 2</p>  <p>18-0110 18-0110-9 ① JUNTA Reemplaza: 324670</p>	<p>Pack. de 2</p>  <p>18-0313 JUNTA VARILLA Reemplaza: 352165 Para: E-Tec 75/90/115/150/ 175/200/225/250 HP</p>
<p>Pack. de 2</p>  <p>18-0882 18-0882-9 ① JUNTA VARILLA Reemplaza: 304764</p>	<p>Pack. de 2</p>  <p>18-2855 18-2855-9 ① JUNTA TAPA Reemplaza: 314082</p>	<p>Pack. de 2</p>  <p>18-2874 18-2874-9 ① JUNTA TAPA SOLENOIDE Reemplaza: 314876 V-4</p>	<p>Pack. de 2</p>  <p>18-2880 18-2880-9 ① JUNTA TAPA PLATINA Reemplaza: 304023</p>	<p>Pack. de 2</p>  <p>18-0108 18-0108-9 ① JUNTA CAJA ENGRANAJES Reemplaza: 324449</p>

 <p>18-0540 RETÉN GOMA Reemplaza: 320936</p>	<p>Pack. de 2</p>  <p>18-0949 18-0949-9① JUNTA TAPA Reemplaza: 316499</p>	 <p>18-2537 RETÉN GOMA Reemplaza: 324937</p>	<p>Pack. de 2</p>  <p>18-2869 18-2869-9① JUNTA ALOJA- MIENTO ESCAPE Reemplaza: 305312</p>	<p>Pack. de 2</p>  <p>18-2891 18-2891-9① JUNTA ALOJAMIENTO COJINETE Reemplaza: 303339 6HP</p>
 <p>18-8353 RETÉN ACEITE Reemplaza: 320961</p>	 <p>18-1219 CASQUILLO Reemplaza: 320880</p>	 <p>18-2389 CASQUILLO Reemplaza: 314832</p>	 <p>18-2391 CASQUILLO Reemplaza: 321692</p>	 <p>18-2392 CASQUILLO Reemplaza: 327035</p>
<p>Pack. de 2</p>  <p>18-2703 18-2703-9① CASQUILLO Reemplaza: 314008</p>	 <p>18-2704 CASQUILLO Reemplaza: 320943</p>	<p>Pack. de 2</p>  <p>18-2706 18-2706-9① CASQUILLO Reemplaza: 321008</p>	<p>Pack. de 2</p>  <p>18-2708 18-2708-9① CASQUILLO Reemplaza: 333758</p>	 <p>18-3329 CASQUILLO Reemplaza: 302497 9.9-35 HP</p>
 <p>18-3332 CASQUILLO Reemplaza: 304026</p>	 <p>18-3337 CASQUILLO Reemplaza: 315837 40-50 HP</p>	<p>Pack. de 2</p>  <p>18-1221 18-1221-9① JUNTA RETENEDOR Reemplaza: 330273</p>	 <p>18-2532 RETÉN TAPA Reemplaza: 305762 2 Cil.</p>	 <p>18-2534 RETÉN 40" Reemplaza: 309044 Material equivalente a la bobina # 309044 0.1005 D.E.</p>
 <p>18-7963 ARO TÓRICO Reemplaza: 331353</p>	<p>Pack. de 2</p>  <p>18-2705 18-2705-9① RETÉN ACEITE Reemplaza: 315748</p>	<p>Pack. de 2</p>  <p>18-2769 18-2769-9① RETÉN GOMA Reemplaza: 332000</p>	<p>Pack. de 2</p>  <p>18-0917 JUNTA MOTOR TILT Reemplaza: 311508</p>	 <p>18-8372 RETÉN Reemplaza: 323582 Para: 5 & 7.5 HP (1978-83) fuera bordas</p>

① Precio por pack

Pack. de 2



18-2881
18-2881-9^④
JUNTA ALOJAMIENTO
 Reemplaza: 332403,125530
 Para: 6 Gallon tanque combustible

Pack. de 2



18-2887
18-2887-9^④
JUNTA TANQ. COMB.
 Reemplaza: 302557



18-4904
ARRANQUE UNIVERSAL, CUERDA Y MANETA
 (Usa 9/64" cuerda)
 maneta: 18-4901

CUERDA STARTER



18-4911
 5/32" x 200'
 Reemplaza: 322236, 772577

18-4913
 3/16" x 200'
 Reemplaza: 316705, 772578

18-4914
 1/8" x 200'
 Reemplaza: 316706, 772579



18-1505
ENGRANAJES
 Reemplaza: 318940
 Para: 9.9 - 15HP
 (1974-1992)



18-6501
MUELLE DE ARRANQUE
 Reemplaza: 395460, 307573



18-6503
MUELLE DE ARRANQUE
 Reemplaza: 318944



18-6509
MUELLE DE ARRANQUE
 Reemplaza: 326877



18-6511
MUELLE DE ARRANQUE
 Reemplaza: 312932



18-6522
MUELLE DE ARRANQUE
 Reemplaza: 323653, 338534

H.P.	AÑOS	MUELLE ARRANQUE	H.P.	AÑOS	MUELLE ARRANQUE	H.P.	AÑOS	MUELLE ARRANQUE	H.P.	AÑOS	MUELLE ARRANQUE
2	1969-80	18-6511	4.5	1980-90	18-6511	10	1950-63	18-6501	18	1968-73	18-6501
3	1954-68	18-6501	5.5	1954-68	18-6501	12	1980-92	18-6522	20	1956-73, 85-97	18-6501
4 ^①	1969-92	18-6511	7.5	1954-68	18-6501	12	1956-68	18-6501	28	1969-92	18-6501
4 ^②	1969-80	18-6511	9.9	1980-92	18-6522	15	1979-92	18-6522	25	1969-05	18-6501
4 ^③	1981-92	18-6509	9.9	1974-78	18-6503	15	1956-68	18-6501	30	1984-05	18-6501
			10	1980-92	18-6522	15	1974-78	18-6503	35	1976-94	18-6501
① Sólo nmodelos1992 4D			③ Todos 4D								
② Excepto 4D											

PACK. DE 3



18-6513
18-6513-9^④
UÑA ARRANQUE
 Reemplaza: 203698

PACK. DE 2



18-6512
18-6512-9^④
UÑA ARRANQUE
 Reemplaza: 330525

HP	Años	Uña	HP	Años	Uña	HP	Años	Uña
2	1971-88	18-6513	18	1957-73	18-6513	30	1984-90	18-6512
Jr/Colt	1990	18-6513	20	1981-90	18-6512	35	1976-77	18-6513
3	1957-67	18-6513	25	1969-76	18-6513	35	1978-90	18-6512
4	1978-90	18-6513	25	1977	18-6513	45	1958-59	18-6513
5.5	1957-64	18-6513	25	1978-90	18-6512	50	1958-89	18-6513
7.5	1957-76	18-6513	25C	1982-90	18-6512	60	1964-66	18-6513
10	1957-62	18-6513	30	1957-61	18-6512	75	1960-65	18-6513
						80	1966	18-6513

④ Precio por envase

- 78 — Gear Housing Seal Kit 18-2658
- 77 — Water Pump Repair Kit W/ HOUSING 18-3382

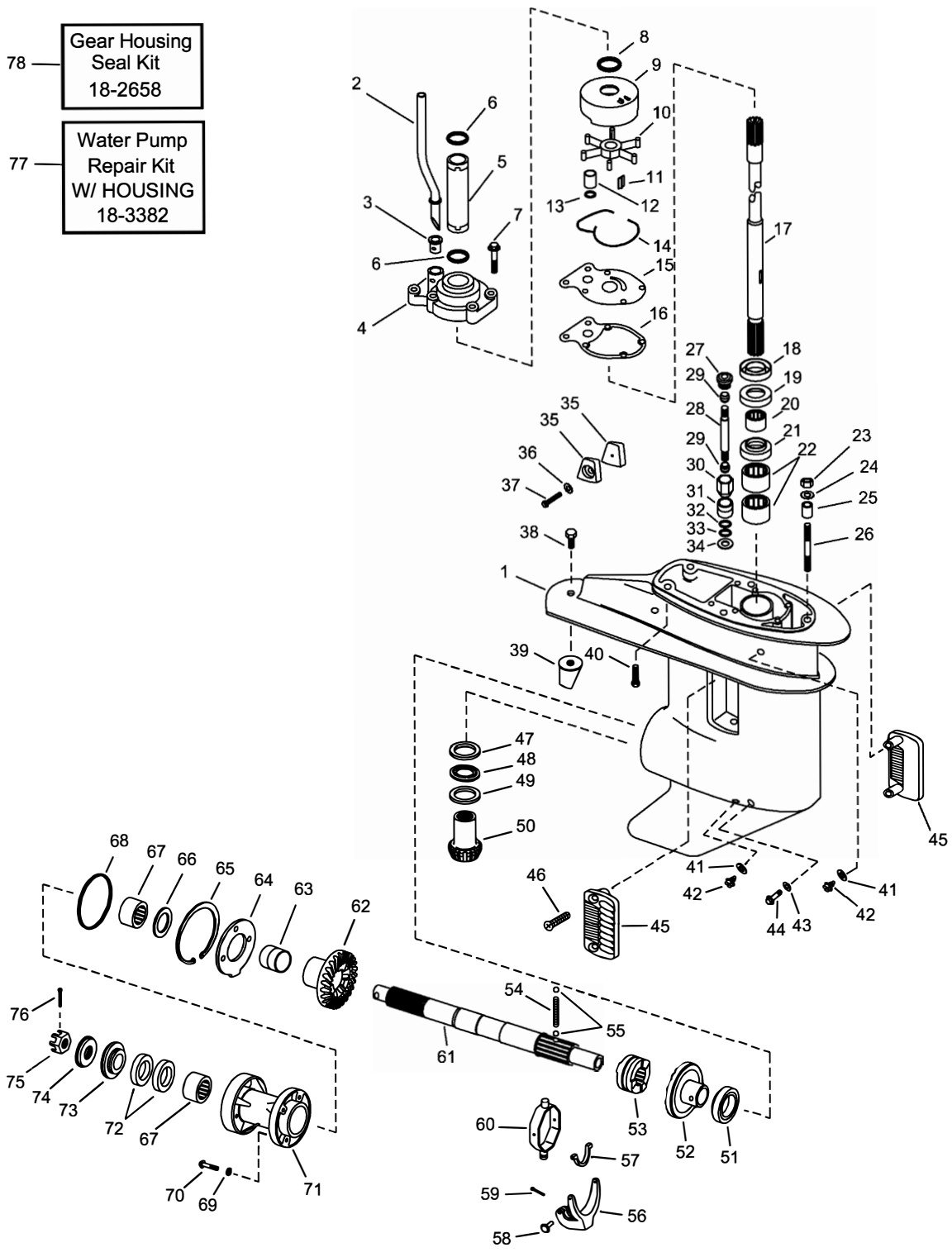

Lista completa de caja de engranajes en la página 102

Fig #	Descripción	Ref #	O.E.M. #	Cant.	Fig #	Descripción	Ref #	O.E.M. #	Cant.
1	Engranajes alojamiento	—	434030	1	46	Tornillo	—	325539	2
2	Tubo agua	—	395339	1	47	Arandela de empuje superior	—	327716	1
3	Casquillo	18-3329	302497	1	48	Cojinete empuje	—	388027	1
4	Alojamiento bomba de agua	18-3367	393632	1	49	Arandela de empuje	—	330441	1
5	Tubo, Extensión	—	326692	1	50	Engranaje	18-1288	328313	1
6	Aro tórico	18-7105	311338	2	51	Cojinete empuje	—	386186	1
7	Tornillo, bomba agua alojamiento	—	328725	6	52	engranaje empuje	18-1287	392475	1
8	Aro tórico	18-7146	554545	1	53	Desplazable	18-1290	337020	1
9	Alojamiento impulsor	18-3358	328751	1	54	Muelle	—	327070	1
10	Impulsor	18-3051	395289	1	55	Bola retención	18-2243	316506	2
11	Llave, bomba de agua	18-3295	344470	1	56	Horquilla leva	—	337019	1
12	Cojinete	—	328754	1	57	Desplazable	—	438311	1
13	Aro	18-7100	301877	1	58	Pivote	—	302504	1
14	Retén goma	18-2539	328753	1	59	Pasador, palanca de cambio	—	303049	1
15	Platina desgaste	18-3359	328753	1	60	Acoplamiento	—	390023	1
16	Junta, bomba de agua	18-0124	325537	1	61	Eje hélice	—	439143	1
17	Eje (15")	—	341635	1	62	Engranaje reverso	18-1289	327655	1
	Eje (20")	—	341636	1	63	Cojinete, engranaje reverso	—	319635	1
18	Eje retén (superior)	18-2065	332261	1	64	Retenedor platina	—	319746	1
19	Eje retén (inferior)	18-2033	321938	1	65	Aro retenedor	—	319747	1
20	Cojinete, eje	—	386473	1	66	Arandela	—	319684	1
21	Collar, alojamiento	—	322018	1	67	Cojinete	—	437288	2
22	Cojinete, Piñon	—	437288	2	68	Aro tórico	18-7108	338518	1
23	Tuerca, alojamiento	—	306422	1	69	Retén	18-7475	332584	2
24	Arandela	—	301250	1	70	Tornillo	—	319743	2
25	Cojinete	—	319785	1	71	Cojinete diablo	—	433428	1
26	Pasador	—	320173	1	72	Retén	18-2026	321453	2
27	Conector	—	325624	1	73	Espaciador	18-4229	319890	1
28	Varilla	—	331479	1	74	Espaciador	18-4232	323943	1
29	Retén	—	325625	2	75	Pasador	18-3707	319891	1
30	Tuerca	—	331465	1	76	kit juntas alojamiento	18-3743	320785	1
31	Eje cambio	—	326361	1	77	kit bomba agua	18-3382	393639	1
32	Aro tórico	18-7180	303347	1	78	kit juntas alojamiento	18-2658	396351	1
33	Aro tórico	18-7100	301877	1					
34	Arandela	18-0189	321738	1					
35	Kit anodo	—	434029	1					
36	Arandela de cierre	—	304454	1					
37	Tornillo	—	333677	1					
38	Tornillo	—	329217	1					
39	Anodo	—	336203	1					
40	Tornillo	—	328333	4					
41	Junta tornillo drenaje	18-4248	311598	2					
42	Tornillo	18-2387	307551	2					
43	Retén	18-7475	332584	1					
44	Pasador	—	308376	1					
45	Rejilla entrada de agua	—	336202, 336206	2					

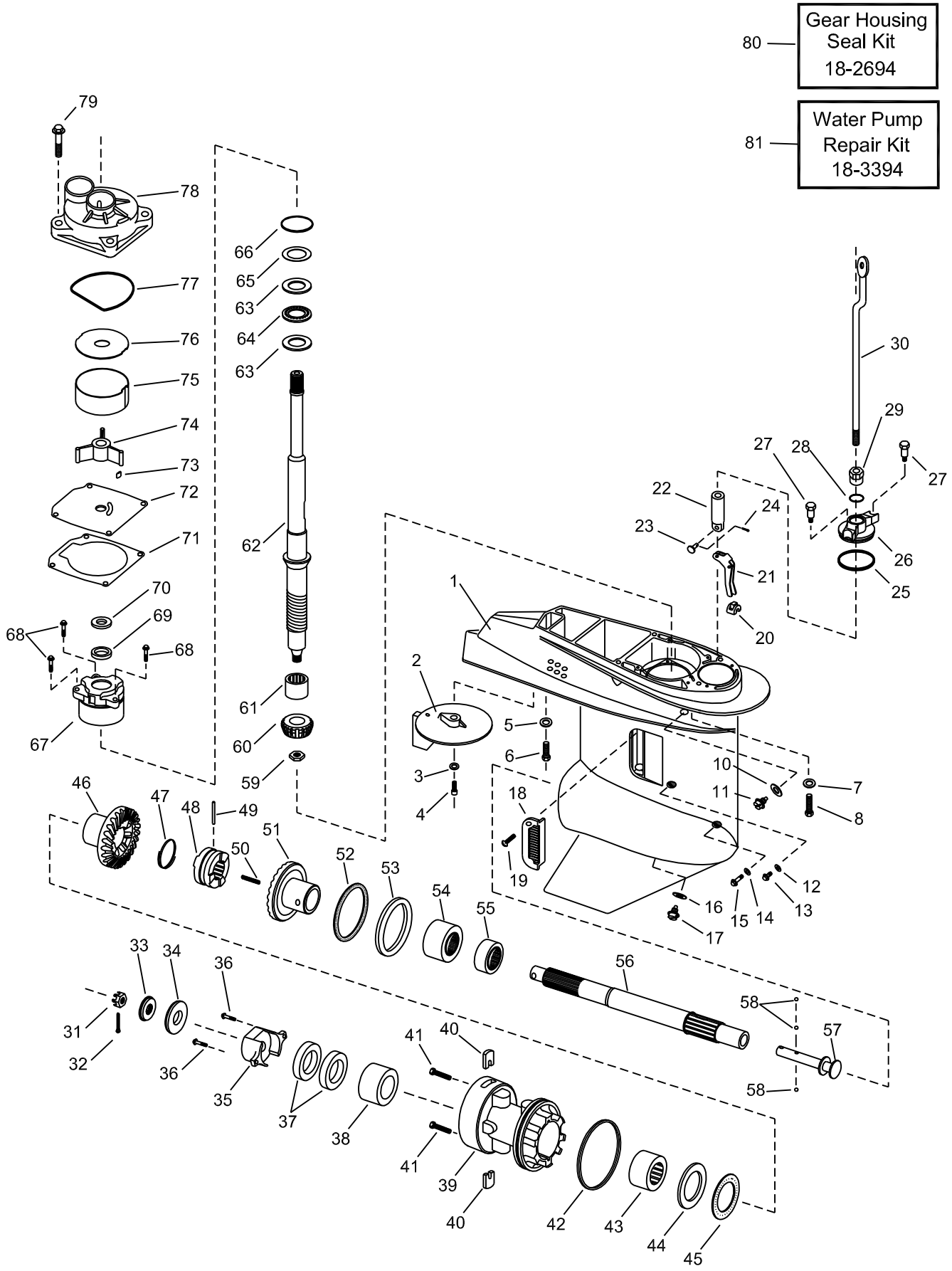

Lista completa de caja de engranajes en la página 102

Fig #	Descripción	Ref #	O.E.M. #	Cant.	Fig #	Descripción	Ref #	O.E.M. #	Cant.
1	Engranajes alojamiento	—	435275	1	47	Muelle	18-2398	320311	1
2	Anodo	—	340539	1	48	Embrague	18-2308	332491	1
3	Arandela, Anodo	—	330266	1	49	Pasador	—	320310	1
4	Tornillo, Anodo retenedor	—	330930	1	50	Muelle	—	332484	1
5	Arandela	—	330265	1	51	Set engranajes	18-2310	397627	1
6	Tornillo	—	313697	1	52	Cojinete empuje	18-1364	397538	1
7	Arandela	—	330266	4	53	Arandela empuje	18-0197	333725	1
8	Tornillo	—	305282	4	54	Cojinete	18-1351	382407	1
10	Aro tórico	18-4253-9	336982	1	55	Cojinete empuje, Engranaje avance	18-1369	432264	1
11	tornillo drenaje superior	18-1236	309243	1	56	Eje hélice	18-2288	439138	1
12	Retén	18-7475	332584	1	57	Eje	—	332503	1
13	Tornillo	—	324852	1	58	Bola retención	18-2243	316506	3
14	Aro tórico, tornillo	18-7109	317178	1	59	Tuerca piñón	—	313339	1
15	Tornillo, palanca de cambio	—	333770	1	60	Set engranajes	18-2310	397627	1
16	Junta,tornillo drenaje	18-4248	311598	1	61	Cojinete piñón	18-1356	382343	1
17	tapón llenado inferior	18-2378	318544	1	62	Transmisión (std)	—	433066	1
18	Rejilla entrada de agua	—	332494	2		Transmisión (larga)	18-1721	433067	1
19	Tornillo	—	325539	2	63	Arandela, empuje	18-0201	333771	2
20	Cuna	—	332507	1	64	Cojinete empuje, Driveshaft	18-1368	398901	1
21	Palanca	—	332492	1	65	Arandela (.003)	—	313273	AR
22	Conector	—	332508	1		Arandela (.004)	—	313274	AR
23	Pasador conector	—	302504	1		Arandela (.005)	—	313275	AR
24	Pasador	—	306376	1		Arandela (.006)	—	313276	AR
25	Aro tórico	—	338522	1		Arandela (.007)	—	313277	AR
26	Tapa	18-1729	434588	1	66	Aro tórico, Engranaje aloj.	18-7173	310327	1
27	Tornillo	—	316037	2	67	Tapa	—	435274	1
28	Aro tórico	18-7137	318372	1	68	Tornillo, Retención de transm.	—	317624	3
29	Cojinete	—	333780	1	69	Retén inferior	18-2059	321466	1
30	Barra (std.)	—	332509	1	70	Retén superior	18-2064	332205	1
	Barra larga	—	332510	1	71	Junta impulsor	18-2709	336530	1
31	Tuerca	18-3705	314503	1	72	Impulsor platina	NSS	341038	1
32	Pasador	18-3742	314502	1	73	LLave impulsor	18-3138	334897	1
33	Espaciador	18-4228	315810	1	74	Impulsor	18-3104-1	432941	1
34	Arandela, hélice	18-4230	320305	1	75	Insert	NSS	324980	1
35	Anodo, Cojinete alojamiento	—	398873	1	76	Casquillo alojamiento	18-3126	321940	1
36	Tornillo, Anodo retenedor	—	328694	2	77	Retén, goma	18-7481	324981	1
37	Retén aceite, Prop eje	18-2060	321467	2	78	Alojamiento, W/P	18-3129	438544	1
38	Cojinete aguja	18-1355	386765	1	79	Tornillo, bomba agua alojamiento	18-3369	302325	4
39	Cojinete	18-1708	432276	1	80	Kit retén alojamiento engr.	18-2694	433550	1
40	Retenedor	18-1343	332495	2	81	Kit reparación bomba agua	18-3394	433548	1
41	Tornillos	—	328744	2					
42	Aro tórico, Cojinete alojamiento	18-7172	553126	1					
43	Cojinete, Aguja	18-1354	386764	1					
44	Arandela empuje, engr.reverso	18-0196	332514	1					
45	Cojinete empuje, Engr. reverso	18-1363	397537	1					
46	Engranaje, Reverso	18-2309	332489	1					

AR Se requiere

NSS No se vende por separado

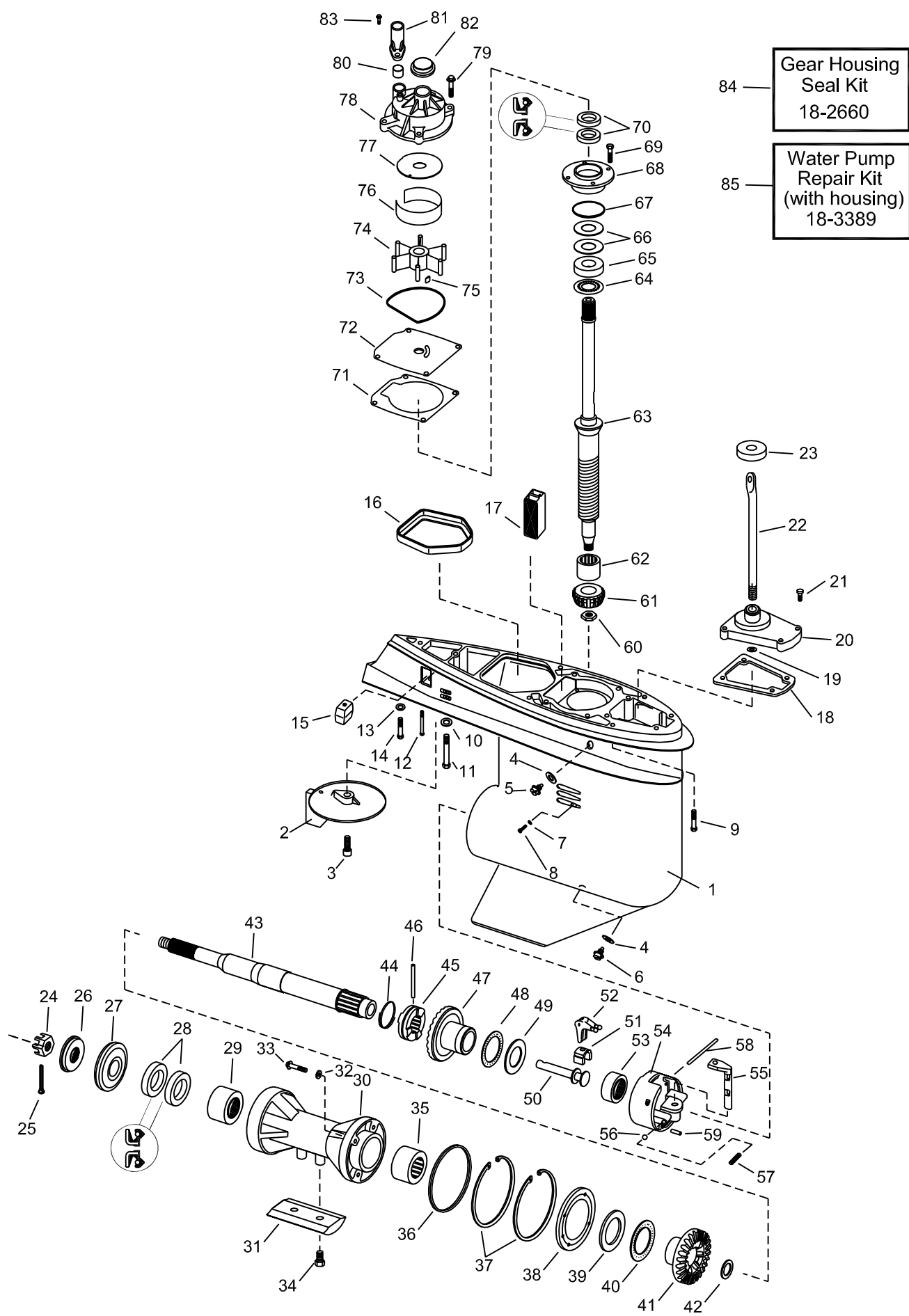

Lista completa de caja de engranajes en la página 102

Fig #	Descripción	Ref #	O.E.M. #	Cant.	Fig #	Descripción	Ref #	O.E.M. #	Cant.
1	Alojamiento engranajes	—	392478	1	43	Eje hélice	18-2250	439185, 439131	1
2	Trim Tab	—	318544	1					
3	Tornillo timón de deriva	—	313715	1	44	Piñones	18-2399	324369	1
4	Aro tórico	18-7145	333572	2	45	Desplazable	18-2209	318303	1
5	Tapón llenado superior	18-2387	307551	1	46	Pasador	18-1714	313448	1
6	Tornillo drenaje	18-2378	318544	1	47	Juego engranaje avante	18-2207	397338	1
7	Retén	18-7475	332584	1	48	Cojinete de empuje	18-1371	385043	1
8	Tornillo	—	324852	1	49	Arandela empuje	18-0198	324766	1
9	Tornillo	—	308843	4	50	Eje corto	—	326668	1
10	Arandela	—	306314	1	51	Acoplamiento	18-3766	334163	1
11	Tornillo largo caja engranajes	—	313697	1	52	Palanca	—	324037	1
12	Tornillo, Anodo	—	328096	1	53	Cojinete alojamiento	NSS	NSS	
13	Arandela	—	306470	1	54	Ensamblaje alojamiento cojinete	—	391365	1
14	Tornillo corto caja de engranajes	—	306503	1	55	Varilla de cambio	—	326670	1
15	Anodo	18-6024	436745	1	56	Bola retención	—	327345	1
16	Retén, Escape	18-2537	324937	1	57	Muelle	—	911961	1
17	Rejilla entrada de agua	—	314175	1	58	Pasador	—	320145	1
18	Junta alojamiento, varilla cambio	18-2855	314082	1	59	Pasador	18-3765	331880	1
19	Aro tórico, varilla de cambio	18-7137	318372	1	60	Tuerca piñon	—	313339	1
20	Alojamiento varilla de cambio	—	388651	1	61	engranaje piñon	NSS	NSS	
21	Tornillo alojamiento bomb.agua	18-3133	302325	4	62	Cojinete piñon	18-1356	382343	1
22	Varilla de cambio	—	327337	1	63	Eje transom	—	437376	1
23	Casquillo	18-2706	321008	1	64	Cojinete empuje	—	317230	1
24	Tuerca hélice	18-3705	314503	1	65	Arandela empuje	18-1367	385068	1
25	Pasador	18-3742	314502	1	66	Arandela (.003)	18-2232	323889	AR
26	Espaciador	18-4228	315810	1	66	Arandela (.004)	18-2233	323890	AR
27	Arandela empuje	18-4222	127084, 318841	1	66	Arandela (.005)	18-2234	317232	AR
28	Retén salida	18-8326	330137	1	67	Aro tórico cojinete alojamiento	18-7128	313754	1
28	Cojinete retén	18-2001	342787	1	68	Alojamiento eje	—	385087	1
29	Cojinete (Aft)	18-1350	379504	1	69	Tornillo	—	909386	4
30	Ensamblaje	—	434391	1	70	Retén	18-8325	342786	1
31	Anodo	—	306470	1	71	Junta bomba agua	18-2709	336530	1
32	Retén	18-7475	332584	4	72	Platina impulsor	18-3127	341038	1
33	Tornillo	18-2379	320041	4	73	Retén alojamiento bomba agua	18-7481	324981	1
34	Tornillo	—	127466	2	74	Impulsor	18-3053-1	396725	1
35	Cojinete	18-1351	382407	1	75	Chaveta	18-3138	334897	1
36	Aro tórico, alojamiento cojinete	18-7127	313446	1	76	Casquillo alojamiento	—	321940	1
37	Aros	—	313445	2	77	Platina	18-3126	324980	1
38	Platina	—	313453	1	78	Alojamiento bomba agua	18-3129	435673	1
39	Arandela empuje larga, Engranaje reverso	18-0193	313447	1	79	Tornillo alojamiento bomba agua	18-3133	302325	1
40	Cojinete empuje, engr. reverso	18-1366	382408	1	80	Casquillo	18-2703	314008	1
41	Engranaje reverso	18-2208	318304	1	81	Guía tubo de agua	—	319276	1
42	Arandela empuje corta, Engranaje reverso	—	316484	1	82	Casquillo	18-2705	342786	1
					83	Tornillo	18-3153	908158	1
					84	Kit retén alojamiento engranaje	18-2660	396349	1
					85	Kit reparación bomba de agua, Completo	18-3389	432955	1

AR Se requiere

NSS No se vende por separado

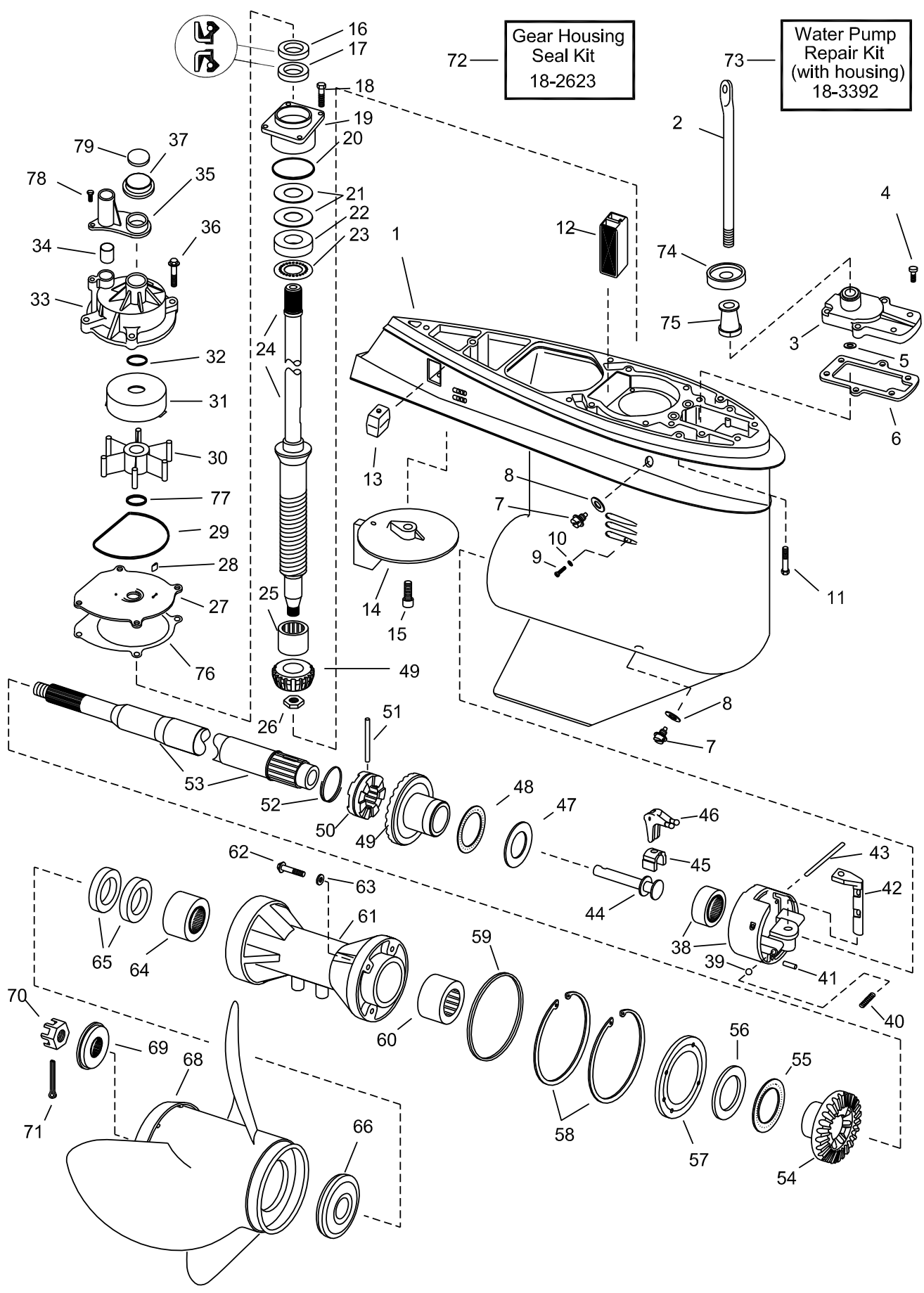

Lista completa de caja de engranajes en la página 102

Fig #	Descripción	Ref #	O.E.M. #	Cant.	Fig #	Descripción	Ref #	O.E.M. #	Cant.
1	Caja engranajes alojamiento	—	431642	1	43	Pasador	—	320145	1
2	Barra (larga)	—	332120	1	44	Eje cambio	18-3763	322941	1
	Barra (extra-larga)	—	332121	1	45	Cuna	18-3766	334163	1
3	Tapa	—	388618	1	46	Palanca	—	324037	1
4	Tornillo	18-3369	302325	6	47	Arandela empuje	18-0198	324766	1
5	Aro tórico	18-7137	318372	1	48	Arandela empuje	18-1371	385043	1
6	Junta	18-0110	324670	1	49	Set engranajes	18-2218	398035	1
7	Tornillo drenaje magnético	18-2378	318544	1	50	Embrague	18-2220	323664	1
8	Aro tórico	18-7145	333572	1	51	Pasador	18-1714	313448	1
9	Tornillo	—	324852	1	52	Muelle	18-2399	324369	1
10	Aro tórico	18-7475	332584	1	53	Eje hélice	18-2252	387818	1
11	Tornillo, caja engranajes aloj.	—	331999	5	54	Engranaje reverso	18-2219	333077	1
12	Rejilla entrada de agua	—	323466	1	55	Cojinete empuje, engr. reverso	18-1366	382408	1
13	Anodo	18-6024	393023	1	56	Arandela empuje, engr. reverso	18-0195	314731	1
14	Anodo	—	327640	1	57	Platina retenedor/Cojinete aloj.	—	314732	1
15	Tornillo	—	313715	1	58	Aros retenedores	—	313445	2
16	Retén aceite, superior	18-2061	329922	1	59	Aros tóricos cojinetes aloj	18-7127	313446	1
17	Retén aceite, inferior	18-2062	329923	1	60	Cojinete	18-1351	382407	1
18	Tornillo, caja engranajes aloj.	—	317624	4	61	Cojinete alojamiento	—	397087	1
19	Cojinete alojamiento	—	397493	1	62	Tornillo	18-2377	316563	4
20	Aro tórico cojinete alojamiento	18-7130	314728	1	63	Aro tórico	18-7475	332583	1
21	Arandela .003	18-2229	323362	AR	64	Cojinete (Aft)	18-1350	379504	1
	Arandela .004	18-2230	323361	AR	65	Retén aceite, eje hélice	18-2001	330137	2
	Arandela .005	18-2231	314745	AR	66	Arandela empuje	18-4222	318841	1
22	Arandela empuje, Piñón	18-0200	327656	1	68	Hélice	—	Various	1
23	Cojinete empuje, Piñón	18-1365	387656	1	69	Espaciador	18-4228	315810	1
24	Eje transmisión (largo)	—	394613	1	70	Tuerca	18-3705	314503	1
	Eje transmisión (x-largo)	—	394614	1	71	Pasador, Tuerca	18-3742	314502	1
25	Cojinete, Piñón	18-1357	384195	1	72	Kit retén alojamiento engranajes	18-2623	396354	1
26	Tuerca, Piñón	18-3719	314730	1	73	Kit reparación bomba agua			
27	Platina desgaste	18-3346	330380	1			18-3392	395062	1
28	Chaveta	18-3299	331107	1	74	Casquillo	18-2706	321008	1
29	Retén alojamiento impulsor	18-7963	331353	1	75	Espaciador	—	321122	1
30	Impulsor	18-3059	395864	1	76	Junta, Impulsor aloj. platina	18-2557	324701	1
31	Tapa impulsor	18-3346	330379	1	77	Aro tórico	—	302035	1
32	Aro tórico, eje transmisión	18-2769	332000	1	78	Tornillo, tapa impulsor	18-3135	306643	2
33	bomba agua alojamiento	18-3130	395040	1	79	Aro tórico	18-7158	310585	1
34	Casquillo tubo agua	18-2703	314008	1					
35	Tapa bomba	—	321159	1					
36	Tornillo impulsor alojamiento	—	328715	4					
37	Casquillo	18-2704	320943	1					
38	Cojinete alojamiento ensamblaje	—	391365	1					
39	Bola retención	—	327345	1					
40	Muelle	—	326666	1					
41	Pasador alojamiento	18-3765	331880	1					
42	Varilla retención	—	323946	1					

AR Se requiere

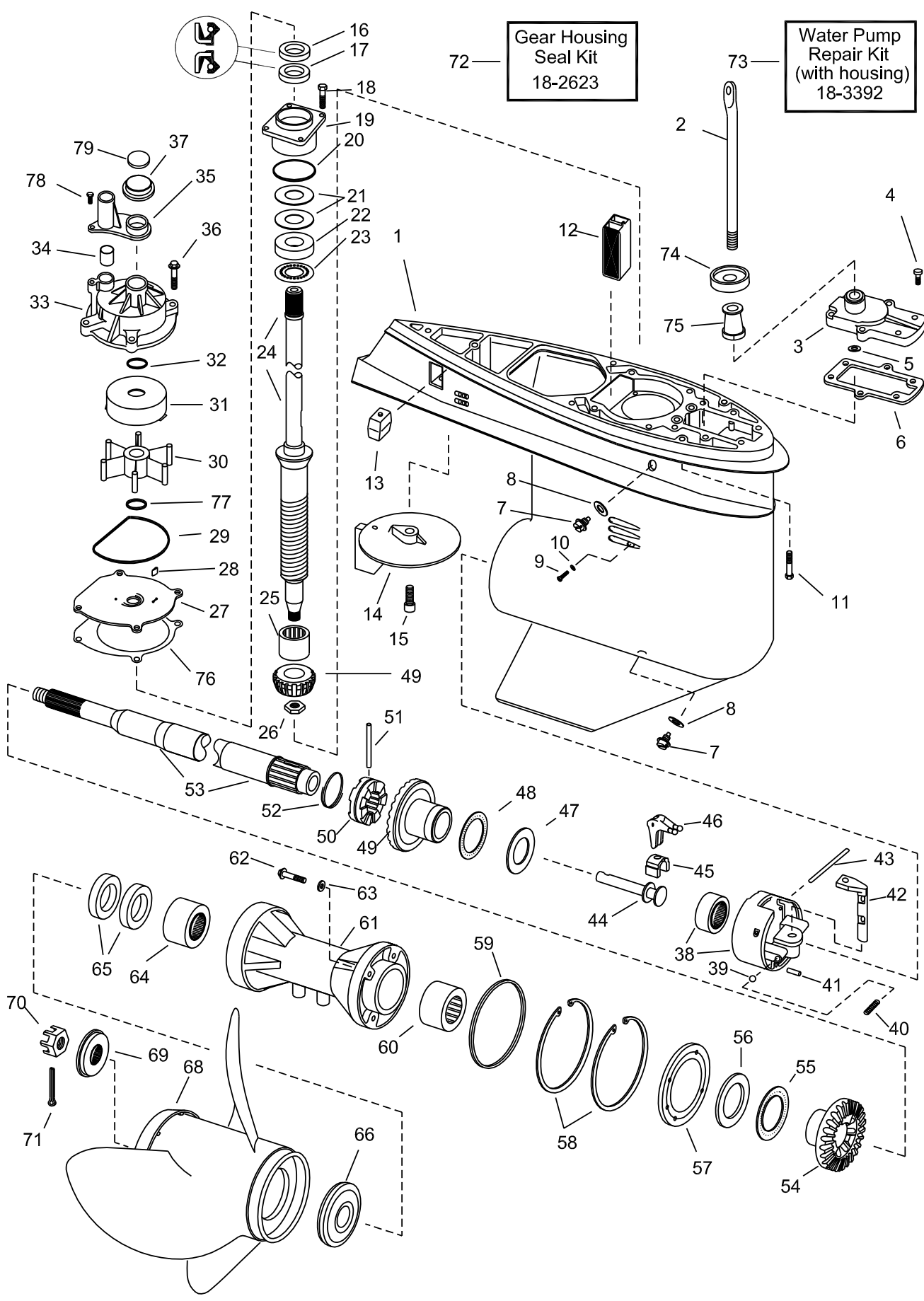

Lista completa de caja de engranajes en la página 102

Fig #	Descripción	Ref #	O.E.M. #	Cant.	Fig #	Descripción	Ref #	O.E.M. #	Cant.
1	Caja engranajes	—	438050	1	43	Pasador	—	328825	1
2	Barra (largo)	—	324407	1	44	Eje cambio	18-3763	322941	1
2	Barra (x-largo)	—	324408	1	45	Cuna	18-3766	334163	1
3	Tapa & barra	—	435482	1	46	Palanca	18-3762	322938	1
4	Tornillo tapa	18-3369	302325	6	47	Arandela empuje	18-0199	327669	1
5	Aro tórico	18-7137	318372	1	48	Cojinete empuje	18-1370	389042	1
6	Junta	18-0110	324670	1	49	Set engranajes	NSS	435020	1
7	Tornillo drenaje magnético	18-2378	318544	2	50	Embrague	18-2216	337774	1
8	Aro tórico	18-7145	333572	2	51	Pasador	18-1714	313448	1
9	Tornillo	—	324852	1	52	Muelle retenedor	18-2399	324369	1
10	Aro tórico	18-7120	307853	1	53	Eje hélice	18-2187	395209	1
11	Tornillo,caja engr. aloj.	—	320741	5	54	Engranaje reverso	NSS	910994	1
12	Rejilla entrada de agua	—	321123	1	55	Cojinete empuje, engr.reverso	18-1366	382408	1
13	Anodo	18-6024	393023	1	56	Arandela empuje, engr.reverso	18-0195	314731	1
14	Anodo	—	327640	1	57	Platina retenedora/Cojinete aloj.	—	321174	1
15	Tornillo,Trim tab	—	313715	1	58	Aros retenedores	—	321171	2
16	Retén aceite, superior	18-2061	329922	1	59	Aro tórico , Cojinete alojamiento	18-7133	305123	1
17	Retén aceite, inferior	18-2062	329923	1	60	Cojinetes	18-1351	382407	1
18	Tornillo,caja engranajes aloj.	—	316534	4	61	Cojinete alojamiento	—	397094	1
19	Cojinete alojamiento	—	438963	1	62	Tornillo retenedor	18-2377	316563	4
20	Aro tórico, Cojinete alojamiento	18-7130	314728	1	63	Aro tórico	18-7109	317178	1
21	Arandela .003	18-2229	323362	AR	64	Cojinete (Aft)	18-1158	387247	1
21	Arandela .004	18-2230	323361	AR	65	Retén aceite, eje hélice	18-2002	320862	2
21	Arandela .005	18-2231	314745	AR	66	arandela empuje	18-4223	333592	1
22	arandela empuje, Piñón	18-0200	327656	1	68	Hélice	—	various	1
23	Cojinete empuje, Piñón	18-1365	387665	1	69	Espaciador	18-4231	320570	1
24	Drive Shaf (long)	see app chart	435755	1	70	Tuerca, Hélice	18-3708-1	398042	1
24	Drive Shaft (x-long)	see app chart	435756	1	71	Pasador, tuerca Prop	18-3741	306394	1
25	Cojinete, Piñón	18-1117	387817	1	72	Kit retén engranajes alojamiento	18-2623	396353	1
26	Tuerca, piñón	18-3719	314730	1	73	Kit reparación bomba agua	18-3392	434421	1
27	Cup & Plate Assembly	18-3346	330380	1					
28	Chaveta	18-3299	331107	1	74	Casquillo	18-2706	321008	1
29	Retén, alojamiento impulsor	18-7963	331353	1	75	Espaciador	—	321122	1
30	Impulsor	18-3059	397131	1	76	Junta,Impulsor platina aloj.	18-2557	324701	1
31	Montaje Vaso & Platina	18-3346	330379	1	77	Aro tórico	18-7158	310585	1
32	Aro tórico	18-7158	310585	1	78	tornillo, tapa impulsor	18-3135	306643	2
33	Alojamiento, bomba de agua	18-3130	395040	1	79	Aro tórico	18-7158	310585	1
34	Casquillo, tubo de agua	18-2703	314008	1					
35	Tapa bomba	—	321159	1					
36	Tornillo, impulsor alojamiento	18-3136	323626	4					
37	Casquillo	18-2704	320943	1					
38	Cojinete alojamiento	—	389455	1					
39	Bola retención	18-1501	160084	1					
40	Muelle retención	18-1502	911962	1					
41	Pasador alojamiento	18-3765	331880	1					
42	Retenedor	—	323946	1					

AR Se requiere



18-4840^②
TRANSMISIÓN COMPLETA
PARTE INFERIOR
 Reemplaza: 435277
 Para: 40/48/50hp c/20" Eje (1989-92)



18-4841^②
TRANSMISIÓN COMPLETA
PARTE INFERIOR
 Reemplaza: 435276
 Para: 40/48/50hp c/15" Eje (1989-92)



18-4843^②
TRANSMISIÓN COMPLETA PARTE
INFERIOR
 Reemplaza: 435279
 Para: 40/48/50hp c/15" Eje (1993 y sup)

Pack. de 5



18-2377
18-2377-9^①
TORNILLO DE
DRENAJE
 Reemplaza: 316563

Pack. de 4



18-2379
18-2379-9^①
TORNILLO UNIDAD
INFERIOR
 Reemplaza: 320041



18-4826
TORNILLO
 Reemplaza: 331999

Pack. de 5



18-4253-9^①
18-42531-9^①
 (PACK. DE 50)
TORNILLO DRENAJE
ARO TÓRICO
 Reemplaza: 336982
 Use con 18-1236 tornillo drenaje

Pack. de 5



18-4248
18-4248-9^①
18-42481-9^①
 (PACK. DE 50)
ARANDELA
 (Plastico)
 Reemplaza: 311598
 Use con 18-2387 tornillo drenaje

Pack. de 2



18-2945
18-2945-9^①
18-29451-9^①
 (Pack. de 50)
JUNTA TORNILLO
DRENAJE
 Reemplaza: 307552



18-1236
TORNILLO DRENAJE
 Reemplaza: 309243
 Para: 40-50 HP (1989-97)
 Cobra



18-2387
18-23871-9^①
 (Pack. de 50)
TORNILLO
 Cabeza con ranura



18-4255
E-TEC TORNILLO
DRENAJE
 Reemplaza: 307551
 Cabeza allen

Display
Package



18-2378
18-23781-9^①
 (Pack. de 50)
TORNILLO DRENAJE
MAGNÉTICO
 Cabeza con ranura

^① Precio por pack

^② Todas las colas de las anteriores fotos deben pintarse.



18-4249
TORNILLO DRENAJE
MAGNÉTICO E-TEC
Reemplaza: 318544
Cabeza allen



18-3708-1
TUERCA
Reemplaza: 398042



Pack. de 5

TUERCA HÉLICE

REF #	O.E. #
18-3705 ^②	314503
18-3706 ^②	318971
18-3707 ^②	319891



Pack. de 10

PASADORES

REF #	O.E. #	DIMEN.
18-3735 ^②	5030087	5/32" X 1 3/8"
18-3740 ^②	302804	3/32" X 1"
18-3741 ^②	309955	1/8" X 1 3/4"
18-3742 ^②	314502	1/8" X 1 1/4"
18-3743 ^②	320785	1/8" X 3/4"
18-3744 ^②	552906	3/32" X 3/4"



^③18-3715D Display Package

18-3715
KIT TUERCAS
Reemplaza: 175266
– CONTIENE –

Ref #	O.E. #	Descripción
18-3708-1	398042	Tuerca hélice
18-3741	309955	Pasador
18-4231	320570	Espaciador



^③18-3716D Display Package

18-3716
KIT TUERCAS HÉLICE
Reemplaza: 175267
– CONTIENE –

Ref #	O.E.#	Descripción
18-3705	314503	Tuerca hélice
18-3742	314502	Pasador
18-4228	315810	Espaciador



^③18-3717D Display Package

18-3717
KIT TUERCAS HÉLICE
Reemplaza: 175268
– CONTIENE –

Ref #	O.E. #	Descripción
18-3707	319891	Tuerca hélice
18-3743	320785	Pasador
18-4232	323943	Espaciador



18-3753
KIT TUERCA HÉLICE
Reemplaza: 5005034
Para: 40-130 (2001 & sup)



18-3768
TUERCA
Reemplaza: 911751
Para: Cobra: 115 (1994-97),
232 (1987-90), 252 (1986), 262 (1989),
302 (1987)



18-4222
ARANDELA EMPUJE
Reemplaza: 318841, 127084



18-4223
ARANDELA EMPUJE
Reemplaza: 333592



18-4228
ESPACIADOR
Reemplaza: 315810



18-4229
ARANDELA EMPUJE
Reemplaza: 319890



18-4230
ARANDELA EMPUJE
Reemplaza: 320305



18-4231
ESPACIADOR
Reemplaza: 320570



18-4232
ESPACIADOR
Reemplaza: 323943

APLICACIONES EN LA SIGUIENTE PÁGINA

① Precio por pack ② Precio por pieza. Para pedir envasado añadir-9 a la referencia.
③ Referencias con D envasadas. Referencias normales no envasadas

JOHNSON/EVINRUDE						
HP	Año	Espaciador anterior hélice	Arandela posterior hélice	Tuerca hélice	Pasador	Kit Tuerca
9.9/15	1974-75	—	—	18-3706	18-3740	—
9.9/15	1976-99	—	—	18-3706	18-3744	—
20	1984-90	18-4229	18-4232	18-3707	18-3743	18-3717
20/30/35	1991-99	—	18-4232	18-3707	18-3743	18-3717
25 ⑥	1991	—	18-4232	18-3707	18-3743	18-3717
25 ⑦	1991	18-4232	18-4228	18-3705	18-3742	18-3716
25 ⑧	1992	—	18-4232	18-3707	18-3743	18-3717
25/30	1984-90	18-4229	18-4232	18-3707	18-3743	18-3717
35	1976-90	18-4229	18-4232	18-3707	18-3743	18-3717
40 ① ④	1984-99	18-4230	18-4228	18-3705	18-3742	18-3716
40 Comm	1996-97	18-4222	18-4228	18-3705	18-3742	18-3716
40 Comm	1998-99	—	18-4228	18-3705	18-3742	18-3716
45 Comm ②	1986-97	—	18-4228	18-3705	18-3742	18-3716
48 ①	1987-96	18-4230	18-4228	18-3705	18-3742	18-3716
50/60 TTL	1996-98	18-4222	18-4228	18-3705	18-3742	18-3716
50 ②	1971-74	18-4222	18-4228	18-3705	18-3742	18-3716
50 ① ④	1975-99	18-4230	18-4228	18-3705	18-3742	18-3716
50 EL&DT	1996-98	—	18-4228	18-3705	18-3742	18-3716
50 Comm ②	1977-79	18-4222	18-4228	18-3705	18-3742	18-3716
55	1968-69	18-4222	18-4228	18-3705	18-3742	18-3716
55 ①	1976-79	18-4230	18-4228	18-3705	18-3742	18-3716
55 Comm ②	1980-97	18-4222	18-4228	18-3705	18-3742	18-3716
55 Comm	1998-99	—	18-4228	18-3705	18-3742	18-3716
60/70 ④	1996-99	—	18-4228	18-3705	18-3742	18-3716
60	1970-71, 1986-95	18-4222	18-4228	18-3705	18-3742	18-3716
60 ①	1980-85	18-4230	18-4228	18-3705	18-3742	18-3716
65	1972-73	18-4222	18-4228	18-3705	18-3742	18-3716
65 Comm	1984-95	18-4222	18-4228	18-3705	18-3742	18-3716
65 Comm	1996-99	—	18-4228	18-3705	18-3742	18-3716
70	1974-95	18-4222	18-4228	18-3705	18-3742	18-3716
75 ②	1975-84	18-4222	18-4228	18-3705	18-3742	18-3716
75 ①	1975-85	18-4230	18-4228	18-3705	18-3742	18-3716
Formula E	1986-90	18-4230	18-4228	18-3705	18-3742	18-3716
Sprint	1986-90	18-4230	18-4228	18-3705	18-3742	18-3716
85	1969-80, 1995	18-4222	18-4228	18-3705	18-3742	18-3716
88/90	1981-95	18-4222	18-4228	18-3705	18-3742	18-3716
88	1996	—	18-4228	18-3705	18-3742	18-3716
90 ① ④	1996-99	—	18-4228	18-3705	18-3742	18-3716
90 ②	1996	—	18-4231	18-3708-1	—	—
90 V-4 ④	1997-99	—	18-4228	18-3705	18-3742	18-3716
90 V-4 ② ④	1997	18-4223	18-4231	18-3708-1	—	—
90 FSX/ FPX ④	1998-99	18-4223	18-4231	18-3708-1	—	—
100	1979-80	18-4222	18-4228	18-3705	18-3742	18-3716
100 ⑨	1988-94	18-4222	18-4228	18-3705	18-3742	18-3716
100 ⑩	1992	—	18-4231	18-3708-1	—	—
100 Comm ④	1996, 1998	—	18-4228	18-3705	18-3742	18-3716
100 Comm	1995-97, 1999	18-4223	18-4231	18-3708-1	—	—
100 Comm ③	1984-90	18-4223	18-4231	18-3708-1	18-3741	18-3715
110	1986-89	18-4222	18-4228	18-3705	18-3742	18-3716
112	1996	—	18-4228	18-3705	18-3742	18-3716
115	1973-94	18-4222	18-4228	18-3705	18-3742	18-3716
115 ① ④	1996-99	—	18-4228	18-3705	18-3742	18-3716
115 ②	1996	—	18-4231	18-3708-1	—	—
115 V-4 ④	1997-99	—	18-4228	18-3705	18-3742	18-3716
115 V-4 ② ④	1997	18-4223	18-4231	18-3708-1	—	—
115 FSX/ FPX ④	1998-99	18-4223	18-4231	18-3708-1	—	—
120 ③	1985	18-4223	18-4231	18-3708-1	18-3741	18-3715

APLICACIONES CONTINUAN EN LA SIGUIENTE PÁG.

① Modelos equipados con caja de engranajes pequeña.

② Modelos equipados con caja de engranajes grande

③ Modelos equipados con caja engr. V-6

④ Para hélice de 3 palas

⑤ Use 18-4222 para hélices 4 palas

⑥ Todos modelos excepto DR, DE & DT

⑦ Sólo modelos DR, DE & DT

⑧ Excepto modelos RSU, RSLU, RWENB, RWLENB

⑨ Excepto modelos 1992 WTLNE, WTXNENE

⑩ Modelos WTLNE, WTXNENE

⑪ 1992 ES models only

⑫ Except 1992 ESX models

⑬ Sólo modelos 1992 TL

⑭ Sólo modelos 1992 CX, TX

JOHNSON/EVINRUDE						
HP	Año	Espaciador Anterior hélice	Arandela Posterior hélice	Tuerca Hélice	Pasador	Kit Tuerca
120	1986-94	18-4222	18-4228	18-3705	18-3742	18-3716
125 ①	1971-94	18-4222	18-4228	18-3705	18-3742	18-3716
125 ②	1992	—	18-4231	18-3708-1	—	—
125 Comm	1991	—	18-4231	18-3708-1	18-3741	18-3715
125 Comm	1992-96	18-4223	18-4231	18-3708-1	—	—
130	1995-99	18-4223	18-4231	18-3708-1	—	—
135	1973-76	18-4222	18-4228	18-3705	18-3742	18-3716
140	1977-84	18-4222	18-4228	18-3705	18-3742	18-3716
140 ③	1985	18-4223	18-4231	18-3708-1	18-3741	18-3715
140 ⑥	1986-94	18-4222	18-4228	18-3705	18-3742	18-3716
140 ③	1990	18-4223	18-4231	18-3708-1	18-3741	18-3715
140 ④	1992	—	18-4231	18-3708-1	—	—
150	1978-90	18-4223	18-4231	18-3708-1	18-3741	18-3715
150	1991-95	—	18-4231	18-3708-1	18-3741	18-3715
150 ④	1996-99	18-4223	18-4231	18-3708-1	—	—
155 Comm	1984-90	18-4223	18-4231	18-3708-1	18-3741	18-3715
155 Comm	1991-95	—	18-4231	18-3708-1	18-3741	18-3715
175	1977-90	18-4223	18-4231	18-3708-1	18-3741	18-3715
175	1992	—	18-4231	18-3708-1	—	—
175 ④	1993-99	18-4223	18-4231	18-3708-1	—	—
185	1984-85	18-4223	18-4231	18-3708-1	18-3741	18-3715
185 Comm ④	1991-95	—	18-4231	18-3708-1	18-3741	18-3715
200	1976-90	18-4223	18-4231	18-3708-1	18-3741	18-3715
200/225 ④	1991-95	—	18-4231	18-3708-1	18-3741	18-3715
200/225 ④	1996-99	18-4223	18-4231	18-3708-1	—	—
225	1986-90	18-4223	18-4231	18-3708-1	18-3741	18-3715
235	1978-85	18-4223	18-4231	18-3708-1	18-3741	18-3715
250/300	1991	18-4223 ⑤	18-4231	18-3708-1	18-3741	18-3715
250/300	1992	—	18-4231	18-3708-1	—	—
250/300 ④	1993-95	18-4223	18-4231	18-3708-1	—	—
250	1996-99	18-4223	18-4231	18-3708-1	—	—
2.6L	1984-85	18-4223	18-4231	18-3708-1	18-3741	18-3715
275	1986	18-4223	18-4231	18-3708-1	18-3741	18-3715
3.6L	1986-90	18-4223	18-4231	18-3708-1	18-3741	18-3715

OMC SEA DRIVE						
V4	1982-90	18-4222	18-4228	18-3708-1	18-3742	18-3715
V6	1982-90	18-4223	18-4231	18-3708-1	18-3741	18-3715
V8	1987, 1989-90	18-4223	18-4231	—	—	—

- | | | |
|--|--|----------------------------|
| ① Modelos equipados con caja de engranajes pequeña | ⑥ Todos los modelos excepto DR, DE & DT | ① Sólo modelos 1992 ES |
| ② Modelos equipados con caja de engranajes grande | ⑦ Sólo modelos DR, DE & DT | ② Except modelos 1992 ESX |
| ③ Modelos equipados con caja engr. V-6 | ⑧ Excepto modelos RSU, RSLU, RWENB, RWLENB | ③ Sólo modelos 1992 TL |
| ④ Para hélices de 3 palas | ⑨ Excepto 1992 modelos WTLNE, WTXNENE | ④ Sólo modelos 1992 CX, TX |
| ⑤ Use 18-4222 para hélices de 4-palas | ⑩ Modelos WTLNE, WTXNENE | |

 <p>18-8304 RETÉN ACEITE Reemplaza: 321830</p>	 <p>18-0195 ARANDELA EMPUJE Engranaje delantero y posterior Reemplaza: 314731 Para: 45-60 HP - 2 Cil, 3 Cil, V-4 & V-6</p>	 <p>18-0197 ARANDELA EMPUJE Engranaje delantero Reemplaza: 333725 Para: 40-55 HP - 1989-1995</p>	 <p>18-0198 ARANDELA EMPUJE Engranaje delantero Reemplaza: 324766 Para: 3 Cil, V-4 & V-6</p>
 <p>18-0200 ARANDELA EMPUJE EJE TRANSMISIÓN Reemplaza: 327656 Para: V-4 & V-6</p>	 <p>18-0201 ARANDELA EMPUJE Eje transmisión Reemplaza: 333771 Para: 40-60 HP - 1990-1995</p>	 <p>18-1117 COJINETE Reemplaza: 387817</p>	 <p>18-1154 COJINETE A BOLAS Reemplaza: 377139</p>



18-1158
COJINETE A RODILLOS
Reemplaza: 387247



18-1161
COJINETE AGUJAS
Reemplaza: 983891



18-1299
COJINETE
Reemplaza: 433503
Para: motores V4 & V6 60°



18-1344
COJINETE AGUJAS
Ref. # J-1812
Para: Tapa cojinete eje 18-4807
(OE# 439476)



18-1350
COJINETE AGUJAS
Reemplaza: 379504



18-1351
COJINETE AGUJAS
Reemplaza: 382407



18-1354
COJINETE AGUJAS
Reemplaza: 386764



18-1355
COJINETE AGUJAS
Reemplaza: 386765



18-1356
COJINETE AGUJAS
(PIÑÓN)
Reemplaza: 382343



18-1357
COJINETE AGUJAS
(PIÑÓN)
Reemplaza: 384195



18-1363
COJINETE EMPUJE
Reemplaza: 397537



18-1364
COJINETE EMPUJE
Reemplaza: 397538



18-1365
COJINETE EMPUJE
Reemplaza: 387656



18-1366
COJINETE EMPUJE
Reemplaza: 382408



18-1367
COJINETE EMPUJE
Reemplaza: 385068



18-1368
COJINETE EMPUJE
Reemplaza: 398901



18-1369
COJINETE EMPUJE
Reemplaza: 432264



18-1370
COJINETE DE EMPUJE
Reemplaza: 389042



18-1371
COJINETE DE EMPUJE
Reemplaza: 385043

HP	Año	Cojinete Empuje	Cojinete piñón delantero	Cojinete Posterior	Cojinete Empuje	Cojinete empuje rev	Cojinete eje.hel.del	Cojinete Eje he.po.	Cojinete
25D	1989-95	18-1368	18-1356	18-1354	18-1355	18-1364	18-1363	18-1369	18-1351
35	1987	—	—	18-1354	18-1355	—	—	—	—
40	1984-88	—	—	18-1354	18-1355	—	—	—	—
40	1989-Sup	18-1368	18-1356	18-1354	18-1355	18-1364	18-1363	18-1369	18-1351
45 Comm	1985-Sup	—	18-1367	18-1356	18-1351	18-1350	18-1371	18-1366	—
48	1987-88	—	—	18-1354	18-1355	—	—	—	—
48	1989-96	18-1368	18-1356	18-1354	18-1355	18-1364	18-1363	18-1369	18-1351
50	1973-74	18-1367	18-1356	18-1351	18-1350	18-1366	18-1366	—	—
50	1975	—	—	18-1354	18-1355	—	—	—	—
50	1979-88	—	—	18-1354	18-1355	—	—	—	—
50	1989-Sup	18-1368	18-1356	18-1354	18-1355	18-1364	18-1363	18-1369	18-1351
50 ①	1995-Sup	18-1367	18-1356	18-1351	18-1350	18-1371	18-1366	—	—
55	1976-81	—	—	18-1354	18-1355	—	—	—	—
55 ②	1980-82	18-1367	18-1356	18-1351	18-1350	18-1366	18-1366	—	—
55 Comm	1983-Up	—	18-1367	18-1356	18-1351	18-1350	18-1371	18-1366	—
60 ②	1980-81	18-1367	18-1356	18-1351	18-1350	18-1366	18-1366	—	—
60	1980-85	—	—	18-1354	18-1355	—	—	—	—
60 ③	1986-87	—	—	18-1354	18-1355	—	—	—	—
60 ④	1986-97	18-1367	18-1356	18-1351	18-1350	18-1371	18-1366	—	—
65	1973	18-1367	18-1356	18-1351	18-1350	18-1371	18-1366	—	—
65 Comm	1984-97	—	18-1367	18-1356	18-1351	18-1350	18-1371	18-1366	—
70 ④	1974-97	18-1367	18-1356	18-1351	18-1350	18-1371	18-1366	—	—
70 ③	1979-85	—	—	18-1354	18-1355	—	—	—	—
75 ④	1975-88	18-1367	18-1356	18-1351	18-1350	18-1371	18-1366	—	—
75 ③	1979-87	—	—	18-1354	18-1355	—	—	—	—
85	1973-80	18-1365	18-1357	18-1351	18-1350	18-1371	18-1366	—	—
85	1991-95	18-1365	18-1357	18-1351	18-1350	18-1371	18-1366	—	—
88	1987-96	18-1365	18-1357	18-1351	18-1350	18-1371	18-1366	—	—
90	1981-97	18-1365	18-1357	18-1351	18-1350	18-1371	18-1366	—	—
100	1979-80	18-1365	18-1357	18-1351	18-1350	18-1371	18-1366	—	—
100	1990-94	18-1365	18-1357	18-1351	18-1350	18-1371	18-1366	—	—
100 Comm	1984-90	—	18-1365	18-1117	18-1351	18-1158	18-1370	18-1366	—
100 Comm ⑧	1989-90	—	18-1365	18-1357	18-1351	18-1350	18-1371	18-1366	—
100 Comm	1991-93	—	18-1365	18-1117	18-1351	—	18-1370	18-1366	—
110	1986-89	18-1365	18-1357	18-1351	18-1350	18-1371	18-1366	—	—
112	1994-95	18-1365	18-1357	18-1351	18-1350	18-1371	18-1366	—	—
115	1973-85	18-1365	18-1357	18-1351	18-1350	18-1371	18-1366	—	—
115	1990-95	18-1365	18-1357	18-1351	18-1350	18-1371	18-1366	—	—
120	1985	18-1365	18-1117	18-1351	18-1158	18-1370	18-1366	—	—
120	1986-92	18-1365	18-1357	18-1351	18-1350	18-1371	18-1366	—	—
125 Comm ⑤	1989-90	—	18-1365	18-1117	18-1351	18-1158	18-1370	18-1366	—
125 Comm ⑥	1989-90	—	18-1365	18-1357	18-1351	18-1350	18-1371	18-1366	—
125 Comm	1991-94	—	18-1365	18-1117	18-1351	—	18-1370	18-1366	—
125	1992	18-1365	18-1357	18-1351	18-1350	18-1371	18-1366	—	—
135	1973-76	18-1365	18-1357	18-1351	18-1350	18-1371	18-1366	—	—
140	1977-84	18-1365	18-1357	18-1351	18-1350	18-1371	18-1366	—	—
140	1985	18-1365	18-1117	18-1351	18-1158	18-1370	18-1366	—	—
140	1986-92	18-1365	18-1357	18-1351	18-1350	18-1371	18-1366	—	—
140 TX	1988-90	18-1365	18-1117	18-1351	18-1158	18-1370	18-1366	—	—
140 TX	1991-92	18-1365	18-1117	18-1351	—	18-1370	18-1366	—	—
150	1978-90	18-1365	18-1117	18-1351	18-1158	18-1370	18-1366	—	—
150	1991-95	18-1365	18-1117	18-1351	—	18-1370	18-1366	—	—
150 Comm	1993-95	—	18-1365	18-1117	18-1351	—	18-1370	18-1366	—
155 Comm	1984-90	—	18-1365	—	18-1351	18-1158	—	18-1366	—
155 Comm ⑤	1989-90	18-1365	18-1117	18-1351	18-1158	18-1370	18-1366	—	—
155 Comm ⑦	1989-90	18-1365	18-1117	18-1351	18-1158	18-1370	18-1366	—	—
175	1977	18-1365	18-1117	18-1351	18-1158	—	18-1366	—	—
175	1978-90	18-1365	18-1117	18-1351	18-1158	18-1370	18-1366	—	—
175	1991-97	18-1365	18-1117	18-1351	—	18-1370	18-1366	—	—
185	1984-85	18-1365	18-1117	18-1351	18-1158	18-1370	18-1366	—	—
185	1990	18-1365	18-1117	18-1351	18-1158	18-1370	18-1366	—	—
185	1992-94	18-1365	18-1117	18-1351	—	18-1370	18-1366	—	—
200	1976-77	18-1365	18-1117	18-1351	18-1158	—	18-1366	—	—
200	1978-90	18-1365	18-1117	18-1351	18-1158	18-1370	18-1366	—	—
200	1991-97	18-1365	18-1117	18-1351	—	18-1370	18-1366	—	—
200 Comm	1990-91	—	18-1365	18-1117	18-1351	18-1158	18-1370	18-1366	—
225	1986-90	18-1365	18-1117	18-1351	18-1158	18-1370	18-1366	—	—
225	1991-97	18-1365	18-1117	18-1351	—	18-1370	18-1366	—	—
235	1978-85	18-1365	18-1117	18-1351	18-1158	18-1370	18-1366	—	—

① Modelos 3 cilindros

③ Modelos 15" Transom

⑤ Modelos WTP

⑦ Sólo modelos WTA

② Modelos cuerda arranque

④ Modelos 20" Transom

⑥ Modelos ESX

⑧ Sólo modelos con prefijo "S"

EJES FUERABORDAS



18-1723
EJE INFERIOR
 Reemplaza: 346004
 Para: V4 60° incluye: E100, E115, E75, E 90, J115 & J90



18-2277
EJE INFERIOR
 Reemplaza: 335722



18-2279
EJE INFERIOR
 Reemplaza: 335679



18-9219
EJE INFERIOR
 Reemplaza: 335677



18-1722
EJE TRANSMISIÓN
 Reemplaza: 438399
 Para: 20" Modelos, 40-50HP (1997-99)



18-1721
EJE TRANSMISIÓN
 Reemplaza: 433067
 Para: 20" Modelos, 40-50(1989-92)



18-2327
EJE SUPERIOR
 Reemplaza: 436234



18-2326
EJE SUPERIOR
 Reemplaza: 436232



18-2330
EJE SUPERIOR
 (Extra Largo)
 Reemplaza: 436235



18-1732
EJE INFERIOR
 Reemplaza: 338504
 Para: V4 & V6 eje transmisión



18-2093
RETÉN
 Reemplaza: 319664, 333096, 398051
 Para: 20 - 35 HP(1977-95) retén para eje hélice 18-2026, eje transmisión 18-2033, cárter superior 18-8351

HP	Año	Eje Inferior	Eje superior	Eje Superior (Extra Largo)	HP	Año	Eje Inferior	Eje superior	Eje (Extra Largo)
85 TTL	1991	18-2277	—	—	140 TX	1990-91	18-9219	—	—
85 TTL	1992-95	18-2277	18-2326	—	140 TL	1991-94	18-2277	18-2326	—
88	1991	18-2277	—	—	140 TX	1992-94	18-9219	—	—
88	1992-96	18-2277	18-2326	—	150	1990	18-9219	—	—
90	1991	18-2277	—	—	150	1991	18-9219	—	—
90	1992-97	18-2277	18-2326	—	150	1992-97	18-9219	18-2327	18-2330
90 ① ②	1995-96	—	18-2327	—	150 Comm	1993-95	18-9219	18-2327	18-2330
90 ② ③	1995-96	18-9219	—	18-2330	155 Comm	1990	18-2279③	—	—
90 ②	1997	18-2277	18-2326	—	155 Comm ⑤	1990	18-9219	—	—
100	1991	18-2277	—	—	155 Comm	1991	18-9219	—	—
100	1992-94	18-2277	18-2326	—	155 Comm	1992	18-9219	18-2326	—
100 Comm	1991	18-9219	—	—	175	1990	18-9219	—	—
100 Comm	1992-97	18-9219	18-2326	—	175	1991	18-9219	—	—
112	1994-96	18-2277	18-2326	—	175	1992-97	18-9219	18-2327	18-2330
115	1991	18-2277	—	—	185	1990	18-9219	—	—
115	1992-97	18-2277	18-2326	—	185	1991	18-9219	—	—
115 ① ②	1995-96	—	18-2327	—	185	1992-94	18-9219	18-2326	—
115 ② ③	1995-96	18-9219	—	18-2330	200	1990	18-9219	—	—
115 ②	1997	18-2277	18-2326	—	200	1991	18-9219	—	—
120	1991-93	18-2277	—	—	200	1992-97	18-9219	18-2326	—
120 ④	1993	18-9219	—	—	200 Comm	1990	18-9219	—	—
120 TL	1994	18-2277	18-2326	—	225	1990	18-9219	—	—
120 TX	1994	18-9219	—	—	225	1991	18-9219	—	—
125 Comm	1991-95	18-9219	18-2326	—	225	1992-97	18-9219	18-2326	—
125	1992-93	18-2277	—	—	250	1991-95	18-2279	—	—
125 ④	1993	18-9219	—	—	250	1997	18-2279	—	—
125	1994	18-2277	18-2326	—	300	1990	18-2279	—	—
130	1995-97	18-9219	18-2326	—	300	1991-95	18-2279	—	—

① 20" Modelos ② Modelos 60 grados V ③ 25" Modelos ④ F Sólo sufijo F ⑤ Sólo modelos WTP

18-1725
EJE HÉLICE
Reemplaza: 436834
Para: V4 60HP



18-2187
EJE HÉLICE
Reemplaza: 395209, 391472



18-2250
EJE HÉLICE
Reemplaza: 387879



18-2251
EJE HÉLICE
Reemplaza: 435022, 433017, 436740



18-2252
EJE HÉLICE
Reemplaza: 387818, 436888



18-2355
EJE HÉLICE
Reemplaza: 386659
Para: 35, 40, 48, 50, 55, 60, 70, 75 HP 2 & 3 cil. fuerabordas (1975-1987)



18-2288
EJE HELICE
Reemplaza: 397541, 439138





18-1287
ENGRANAJE Y CASQUILLO
 Reemplaza: 392475
 Para: 25-35HP (1975-88)



18-1291
JUEGO DE ENGRANAJES
 Para: Comercial V4 caja de engranajes
 — CONTIENE —

Ref #	Desc.	O.E.#
NSS	Engranaje avance	435123
NSS	Engranaje reverso	336574
18-2216	Trinquete	337774



18-1292
JUEGO DE ENGRANAJES
 Para: Último modelo V-6 150-225 H.P. con engr. de reverso largo
 — CONTIENE —

Ref #	Desc.	O.E.#
NSS	engranaje avance	5004216
NSS	engranaje reverso	336561



18-1293
JUEGO DE ENGRANAJES
 Para: 20HP (1984-98), 25HP(1985-02),
 30HP (1984-02) 35HP (1984-01)
 — CONTIENE —

Ref #	Desc.	O.E.#
18-1287	Engranaje avance	392475
18-1289	Engranaje reverso	327655
18-1288	Piñón	328313
18-1290	Trinquete	337020



18-1288
ENGRANAJE PIÑÓN
 Reemplaza: 328313
 Para: 25-35HP (1984-96)



18-2207
JUEGO DE ENGRANAJE REVERSO
 Reemplaza: 397338
 Incluye: engranajes avance y piñón



18-2208
ENGRANAJE REVERSO
 Reemplaza: 318304



18-2209
TRINQUETE DESLIZANTE
 Reemplaza: 318303



18-2210
JUEGO DE ENGRANAJES
 — CONTIENE —

Ref #	Desc.	O.E.#
18-2207	Engranaje avance	397338
18-2208	Engranaje reverso	318304
18-2209	Trinquete deslizante	318303



18-2216
TRINQUETE DESLIZANTE
 Reemplaza: 337772, 337774, 334516,
 336562, 910995



18-2217
JUEGO DE ENGRANAJES
 — CONTIENE —

Ref #	Desc.	O.E.#
NSS	Engranaje avance	435020
NSS	Engranaje reverso	910994
18-2216	Trinquete deslizante	337772



18-2218
JUEGO DE ENGRANAJES AVANCE
 Reemplaza: 434063, 989966,
 985050, 436746
 Incluye: Engranaje avance y piñón



18-2219
ENGRANAJE REVERSO
 Reemplaza: 333077, 317838, 340490



18-2220
EMBRAGUE
 Reemplaza: 323664, 320630



18-2221
JUEGO ENGRANAJE
 — CONTIENE —

Ref #	Desc.	O.E.#
18-2218	Engranaje avance	434063
18-2219	Engranaje reverso	333077
18-2220	Trinquete deslizante	323664



18-2287
EMBRAGUE
Reemplaza: 319895



18-2289
JUEGO ENGRANAJES
Reemplaza: 397128, 433570
No se vende por separado



18-2308
EMBRAGUE
Reemplaza: 332491



18-2309
ENGRANAJE REVERSO
Reemplaza: 332489



18-1290
EMBRAGUE
Reemplaza: 337020
Para: 25-35HP (1992-98)

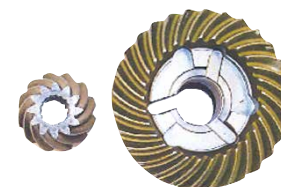

18-2310
JUEGO DE ENGRANAJES AVANCE
Reemplaza: 397627
Incluye: engranaje avance y piñón



18-2315
JUEGO DE ENGRANAJE
– CONTIENE –

Ref #	Desc.	O.E.#
18-2310	juego engranaje avance	397627
18-2309	Engranaje reverso	332489
18-2308	trinquete deslizante	332491



18-2290
JUEGO ENGRANAJE
– CONTIENE –

Ref #	Desc.	O.E.#
NSS	juego engranajes avance	435020, 434026, 983141, 391289
NSS	engranaje reverso	336561
18-2216	trinquete deslizante	337774, 334516, 336562, 910795, 337772



18-1729
TAPA
Reemplaza: 434588
Para: 40HP (1993-02), 48HP (1993-96), 50HP (1993-02)



18-1500
REJILLA ADMISIÓN
Reemplaza: 337778
Para: 100, 120, 125, 140, 150, 175, 200, 225 (1993) (OMC Cobra & V-6)



18-79989
STICKS ARRASTRE
Para: Mayoría de fuerabordas de mas de 150hp con tilt/trim.



18-1343
COJINETE RETENEDOR
Reemplaza: 333957
Para: 100, 120, 125, 140, 150, 175, 200, 225, (1988-92) (Cobra)



18-4807
TAPA COJINETE EJE
Reemplaza: 439476
Para cambio cojinete use 18-1355



18-3766
BASE CAMBIO
Reemplaza: 334163
Para: V-4/V-6, Cobra, Stringer



18-71102
KIT REP. CAVA CONTROL
Para: OMC 397272 + 390610

Pack. de 2



18-2243
18-2243-9^①
BOLA DE RETENCIÓN
 Reemplaza: 316506
 9.9 - 35 HP



18-2398
MUELLE TRINQUETE
 Reemplaza: 320311
 Para: 2 & 3 CIL.



18-2399
MUELLE TRINQUETE
 Reemplaza: 324369
 Para: V-4 & V-6

① Precio por pack

TODOS LOS ENGRANAJES MARCHA AVANTE INCLUYEN PIÑONES

HP	Año	Modelo	Eje Hélice	Juego Engranajes	Engranaje empuje	Engranaje reverso	Embrague
20	1985-95	TODOS		18-1293	18-1287 ⑥	18-1289	18-1290
25	1985-95	TODOS		18-1293	18-1287 ⑥	18-1289	18-1290
25D	1989-95	TODOS	18-2288	18-2315	18-2310	18-2309	18-2308
30	1984-96	TODOS		18-1293	18-1287 ⑥	18-1289	18-1290
35	1984-94	TODOS ⑥		18-1293	18-1287⑥	18-1289	18-1290
35	1987	AE, AR, AT	—	18-2289	—	—	18-2287
40	1984-88	TODOS	—	18-2289	—	—	18-2287
40	1989-97	TODOS	18-2288	18-2315	18-2310	18-2309	18-2308
48	1987-88	TODOS	—	18-2289	—	—	18-2287
48	1989-96	TODOS	18-2288	18-2315	18-2310	18-2309	18-2308
50	1975	TODOS	—	—	—	—	18-2287
50	1979-88	TODOS	—	18-2289	—	—	18-2287
50	1989-97	2 Cil.	18-2288	18-2315	18-2310	18-2309	18-2308
50	1997	3 Cil.	18-2250	—	18-2207	18-2208	18-2209
55	1976-78	TODOS	—	—	—	—	18-2287
60	1980-85	Arranque eléctrico	—	18-2289	—	—	18-2287
60	1986-87	⑥	18-2250	18-2210	18-2207	18-2208	18-2209
60 ⑧	1986-87	3 Cil.	—	—	—	—	18-2287
60	1988-97	TODOS	18-2250	18-2210	18-2207	18-2208	18-2209
65	1984	TODOS	18-2250	18-2210	18-2207	18-2208	18-2209
65	1987	TODOS	18-2250	18-2210	18-2207	18-2208	18-2209
65	1990-91	TODOS	18-2250	18-2210	18-2207	18-2208	18-2209
65 COMM	1985-97	TODOS	18-2250	18-2210	18-2207	18-2208	18-2209
65 COMM Remote	1992-95	TODOS	18-2250	18-2210	18-2207	18-2208	18-2209
65 COMM Rope	1992-95	TODOS	18-2250	18-2210	18-2207	18-2208	18-2209
70	1975	①	N/D	18-2210	18-2207	18-2208	18-2209
70	1976	TODOS	N/D	18-2210	18-2207	18-2208	18-2209
70	1977-85	⑥	18-2250	18-2210	18-2207	18-2208	18-2209
70 ⑧	1979-85	TODOS	—	—	—	—	18-2287
70	1986-97	TODOS	18-2250	18-2210	18-2207	18-2208	18-2209
70TTL	1992-95	TODOS	18-2250	18-2210	18-2207	18-2208	18-2209
75 ⑧	1975-87	TODOS	—	—	—	—	18-2287
75	1976	⑥	N/D	18-2210	18-2207	18-2208	18-2209
75	1977	⑥	18-2250	18-2210	18-2207	18-2208	18-2209
75	1978-80	⑥	18-2250	18-2210	18-2207	18-2208	18-2209
75	1982-87	⑥	18-2250	18-2210	18-2207	18-2208	18-2209
75	2000-01	FPX & FX	18-2251	18-1291	—	—	18-2216
85	1973-77	TODOS	—	—	—	18-2219	—
85	1978-80	TODOS	18-2252	18-2221	18-2218	18-2219	18-2220
85	1991-95	TODOS	18-2252	18-2221	18-2218	18-2219	18-2220
88	1987-96	TODOS	18-2252	18-2221	18-2218	18-2219	18-2220
90	1981-98 ⑨	TODOS	18-2252	18-2221	18-2218	18-2219	18-2220
90	1995-01	25" Transoms	18-2251	18-1291	—	—	18-2216
90	1999	TODOS	18-1725	18-2221	18-2218	18-2219	18-2220
100	1979-80,90-95	TODOS	18-2252	18-2221	18-2218	18-2219	18-2220
100 COMM	1984-90	TODOS	18-2187	—	—	—	18-2216
100 COMM	1989-90,1998	③	18-2252	18-2221	18-2218	18-2219	18-2220
100 COMM	1993-01	TODOS	18-2251	18-1291	—	—	18-2216
105 JET	1992	TODOS	18-2251	18-2217	—	—	18-2216
105	1997-99	TODOS	18-2251	18-1291	—	—	18-2216
105 COMM	2000-01	TODOS	18-2251	18-1291	—	—	18-2216
110	1986-89	TODOS	18-2252	18-2221	18-2218	18-2219	18-2220
112	1994-96	TODOS	18-2252	18-2221	18-2218	18-2219	18-2220
115	1973-76	TODOS	—	—	—	18-2219	—
115	1977	TODOS	18-2252	—	—	18-2219	18-2220
115	1978-85, 1990-98	TODOS	18-2252	18-2221	18-2218	18-2219	18-2220
115	1995-01	25" Transoms	18-2251	18-1291	—	—	18-2216
115	1999	20" 60 Grados V4	18-2252	18-2221	18-2218	18-2219	18-2216
115	1999	25" 60 Grados V4	18-2251	—	—	—	18-2216
120	1985	TODOS	—	—	—	—	18-2216
120	1986-92	TODOS	18-2252	18-2221	18-2218	18-2219	18-2220
120	1993-94	TL & TX ⑩	18-2252	18-2221	18-2218	18-2219	18-2220
120	1993-94	TX ⑩	18-2251	18-1291	—	—	18-2216
125 COMM	1989-90	④	18-2252	18-2221	18-2218	18-2219	18-2220

① Modelos sólo con suf. "E" ⑤ Todos los modelos excepto "ESX"
 ② Modelos sólo con "WTP" ⑥ 20" Sólo Transom
 ③ Modelos sólo con pref. "S"
 ④ Sólo Modelos "ESX"

⑦ 1993 Modelos "ESX" sólo con sufijo "F"
 ⑧ Excepto 1999 modelos "FCX"
 ⑨ Excepto 1998 modelos "FSX"
 ⑩ Modelos sólo con sufijo "F"

⑪ Modelos sólo con sufijo "S"
 ⑫ Para engranajes reversos con 6 enganches
 ⑬ Excepto modelos AE, AR & AT
 ⑭ Piñón 18-1288 se vende por separado

TODOS LOS ENGRANAJES MARCHA AVANTE INCLUYEN PIÑONES

HP	Año	Modelo	Eje hélice	Juego Engranajes	Engranaje Empuje	Engranaje Reverso	Embrague
125 COMM	1989-90	⑤	18-2187	—	—	—	18-2216
125 COMM	1992-94, 1996	⑤	18-2251	—	—	—	18-2216
125	1991	②	18-2251	—	—	—	18-2216
125	1991-95	④ ⑨	18-2252	18-2221	18-2218	18-2219	18-2220
125	1993-95	⑥	18-2251	18-1291	—	—	18-2216
125	1996-98	TODOS	18-2251	18-1291	—	—	18-2216
130	1995-01	TL & TX & 25"	18-2251	18-1291	—	—	18-2216
135	2001	TODOS	18-2251	18-1291	—	—	18-2216
140	1977	TODOS	18-2252	—	—	—	18-2220
140	1978-84, 1986-87	TODOS	18-2252	18-2221	18-2218	18-2219	18-2220
140	1985	TODOS	18-2187	—	—	—	18-2216
140	1988-94	⑦	18-2252	18-2221	18-2218	18-2219	18-2220
140	1988-90	TX	18-2187	—	—	—	18-2216
140	1993-94	TX ⑥	18-2251	18-1291	N/D	N/D	18-2216
150	1978-79	TODOS	—	—	—	—	18-2216 ⑧
150	1980-87	CHECK O.E.	18-2187	18-2217	—	—	18-2216
150	1988-89,90	TODOS	18-2187	18-2217	—	—	18-2216
150	1991-99 ①	TODOS	18-2251	18-2290	—	—	18-2216
150	2004	TODOS	18-2251	18-1292	N/D	N/D	18-2216
150 COMM	1993-96	TODOS	18-2251	18-2290	—	—	18-2216
155 COMM	1984-88	TODOS	18-2187	—	—	—	18-2216
155 COMM WTP	1986-88	TODOS	18-2187	—	—	—	18-2216
155 COMM WTL & WTX	1989-90	TODOS	18-2187	—	—	—	18-2216
155 COMM	1989-90	②	18-2187	18-2217	—	—	18-2216
155 COMM	1991-92	TODOS	18-2251	18-2290	—	—	18-2216
175	1977	TODOS	—	N/D	N/D	N/D	18-2220
175	1978-83	TODOS	—	—	—	—	18-2216
175	1985-90	TODOS	18-2187	18-2217	—	—	18-2216
175/185	1991-99 ①	TODOS	18-2251	18-2290	—	—	18-2216
185	1984-85	TODOS	18-2187	18-2217	—	—	18-2216
200	1979-86	TODOS	—	18-2217	—	—	18-2216
200	1988-90	TODOS	18-2187	18-2217	—	—	18-2216
200	1991-99	TODOS	18-2251	18-2290	—	—	18-2216
200	2002-03	TODOS	18-2251	18-1292	N/D	N/D	18-2216
220	1987	TODOS	18-2187	18-2217	—	—	18-2216
225	1986-87	TODOS	—	18-2217	—	—	18-2216
225	1988-89	TODOS	18-2187	18-2217	—	—	18-2216
225	1991-99	TODOS	18-2251	18-2290	—	—	18-2216
225	2002-04	TODOS	18-2251	18-1292	N/D	N/D	18-2216
235	1979-85	TODOS	—	18-2217	—	—	18-2216
250	1991-99	TODOS	18-2251	—	—	—	18-2216
250	2002-03	TODOS	18-2251	18-1292	N/D	N/D	18-2216
275	1985-88	TODOS	18-2251	—	—	—	18-2216
3.6L	1985-87	TODOS	18-2251	—	—	—	18-2216
300	1988-95	TODOS	18-2251	—	—	—	18-2216

- ② Modelos sólo con "WTP"
- ③ Modelos sólo con prefijo "S"
- ④ Sólo modelos "ESX"
- ⑤ Todos modelos exc. "ESX"
- ⑥ 20" sólo Transom
- ⑦ Todos modelos excepto 140TX
- ⑧ 15" Modelos
- ⑨ 1993 Modelos "ESX" sólo suf. "F"
- ① Excepto 1999 modelos "FCX"
- ② Excepto 1998 modelos "FSX"
- ③ Modelos sólo con suf. "F"
- ④ Modelos sólo con suf. "S"
- ⑤ Para engranajes reverso con 6 enganches
- ⑥ Excepto modelos AE, AR & AT
- ⑦ Piñón 18-1288 se vende por separado

EJES Y ENGRANAJES

HP	Año	Modelo	Eje hélice	Juego engranajes	Engranaje	Engranaje reverso	Embrague
1.6	1990 ①	TODOS	18-2252	18-2221	18-2218	18-2219	18-2220
2	1990 ②	TODOS	18-2187	—	—	—	18-2216
2	1990 ①	TODOS	18-2187	—	—	—	18-2216
3	1990 ①	TODOS	18-2187	18-2217	—	—	18-2216
3	1990	TODOS	18-2187	18-2217	—	—	18-2216
4	1990	TODOS	18-2187	—	—	—	18-2216
1.6	1989	TODOS	18-2252	18-2221	18-2218	18-2219	18-2220
2	1989	TODOS	18-2187	—	—	—	18-2216
3	1989	TODOS	18-2187	18-2217	—	—	18-2216
4	1989	TODOS	18-2187	—	—	—	18-2216
1.6	1988	TODOS	18-2252	18-2221	18-2218	18-2219	18-2220
2	1988	TODOS	18-2187	—	—	—	18-2216
3	1988	TODOS	18-2187	18-2217	—	—	18-2216
1.6	1987	TODOS	18-2252	18-2221	18-2218	18-2219	18-2220
1.8	1987	TODOS	18-2252	18-2221	18-2218	18-2219	18-2220
2.7	1987	TODOS	18-2187	18-2217	—	—	18-2216
3.6	1987	TODOS	18-2187	—	—	—	18-2216
1.6	1986	TODOS	18-2252	18-2221	18-2218	18-2219	18-2220
2.6	1986	TODOS	18-2187	18-2217	—	—	18-2216
1.6 V-4	1985 ③	TODOS	18-2252	18-2221	18-2218	18-2219	18-2220
2.6 V-6	1985 ④	TODOS	18-2187	—	—	—	18-2216
2.5/2.6	1985 ③	TODOS	18-2187	—	—	—	18-2216
1.6 V-4	1984 ③	TODOS	18-2252	18-2221	18-2218	18-2219	18-2220
2.6 V-6	1984 ④	TODOS	18-2187	—	—	—	18-2216
2.5/2.6	1984 ③	TODOS	18-2187	—	—	—	18-2216
1.6	1983	TODOS	18-2252	18-2221	18-2218	18-2219	18-2220
2.6	1983	TODOS	N/D	—	—	—	18-2216
2.5/2.6	1982	TODOS	—	—	—	—	18-2216

- ① Sólo modelos con suf. "E"
- ② Sólo modelos con "WTP"
- ③ Sólo modelos con prefijo "S"
- ④ Sólo modelos "ESX"

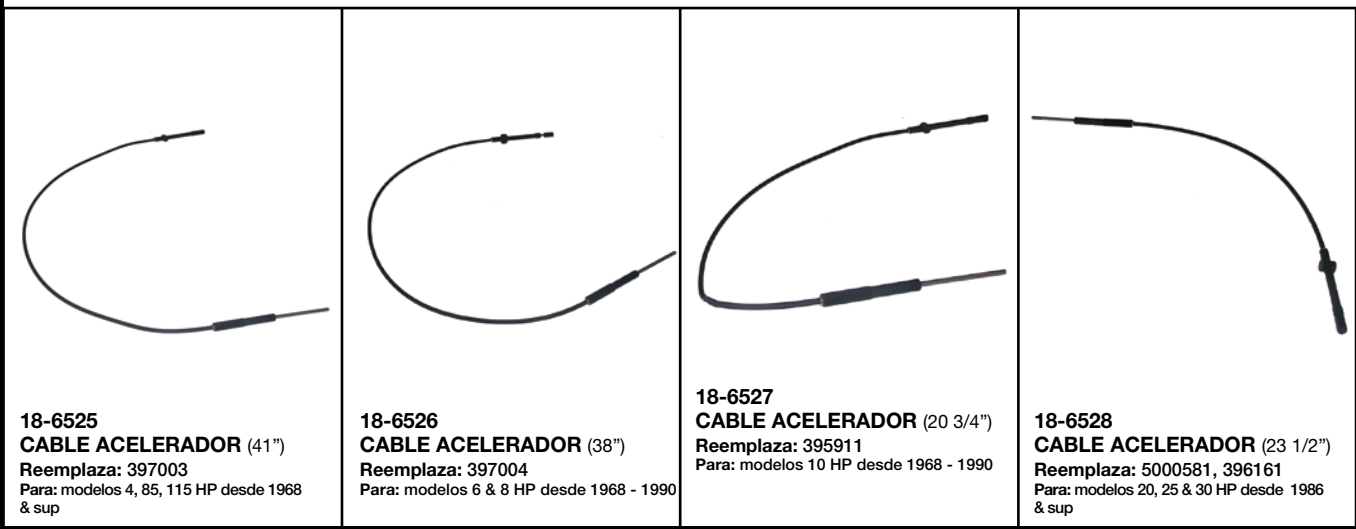

APLICACIÓN CABLE ACELERADOR

HP	AÑO INICIO	AÑO FINAL	CABLE ACELERADOR	HP	AÑO INICIO	AÑO FINAL	CABLE ACELERADOR
4	1987	1996	18-6525	25	1986	1989	18-6528
6	1985	1990	18-6526	25	1999	2005	18-6528
8	1985	1990	18-6526	30	1986	1989	18-6528
9.9	1986	1992	18-6527	30	1999	2005	18-6528
14	1988	1989	18-6526	35	1986	1989	18-6528
15	1986	1992	18-6527	85	1991	1995	18-6525
20	1986	1989	18-6528	115	1994	1995	18-6525

ARANDELAS

Ref #	Desc.	O.E. #	D.I.	Ref #	Desc.	O.E. #	D.I.
18-2224 ^③	.003 Arandela	320166	1.58	18-2230	.004 Arandela	323361	1.24
18-2225 ^③	.004 Arandela	320167	1.56	18-2231	.005 Arandela	314745	1.24
18-2226 ^③	.005 Arandela	320168	1.53	18-2232	.003 Arandela	323889	1.22
18-2227 ^③	.006 Arandela	320169	1.53	18-2233	.004 Arandela	323890	1.22
18-2228	.007 Arandela	320170	1.53	18-2234 ^{① ③}	.005 Arandela	317232	.22

HP	Año	0.003 Arandela	0.004 Arandela	0.005 Arandela	0.006 Arandela	0.007 Arandela
60	1980-1987	18-2224	18-2225	18-2226	18-2227	18-2228
60	1988-95	18-2232	18-2233	18-2234	—	—
60SST	1989-1990	18-2224	18-2225	18-2226	18-2227	18-2228
60TTL	1992	18-2232	18-2233	18-2234	—	—
65C	1984-91,93-95	18-2232	18-2233	18-2234	—	—
65C	1992	18-2232	18-2233	18-2234	—	—
70	1975-76	18-2232	18-2233	18-2234	—	—
70	1977-85	18-2224	18-2225	18-2226	18-2227	18-2228
70	1986-95	18-2232	18-2233	18-2234	—	—
70TTL	1992	18-2232	18-2233	18-2234	—	—
75	1975-1988	18-2224	18-2225	18-2226	18-2227	18-2228

① Envase estándar de 2 ② Incluye 1 cada uno 18-2229, 18-2230 & 18-2231

③ Precio por pieza. Para pedir envasado añadir -9 a la referencia

APLICACIONES CONTINUAN EN LA SIGUIENTE PÁGINA

HP	Año	0.003 Arandela	0.004 Arandela	0.005 Arandela	0.006 Arandela	0.007 Arandela
85	1975-79	18-2229	18-2230	18-2231	—	—
85	1980,91	18-2229	18-2230	18-2231	—	—
85TTL	1992-95	18-2229	18-2230	18-2231	—	—
88	1987-95	18-2229	18-2230	18-2231	—	—
90	1981-95	18-2229	18-2230	18-2231	—	—
100	1979	18-2229	18-2230	18-2231	—	—
100	1980,90-95	18-2229	18-2230	18-2231	—	—
100C	1984-87,89-95	18-2229	18-2230	18-2231	—	—
100PLY	1989	18-2229	18-2230	18-2231	—	—
105JET	1992-93	18-2229	18-2230	18-2231	—	—
110	1986-89	18-2229	18-2230	18-2231	—	—
115	1980-85,90-95	18-2229	18-2230	18-2231	—	—
115	1975-79	18-2229	18-2230	18-2231	—	—
120	1985-95	18-2229	18-2230	18-2231	—	—
125, 125C	1989-95	18-2229	18-2230	18-2231	—	—
125ESX	1989-90	18-2229	18-2230	18-2231	—	—
125WTPL	1990	18-2229	18-2230	18-2231	—	—
135	1975-76	18-2229	18-2230	18-2231	—	—
140	1977-79	18-2229	18-2230	18-2231	—	—
140	1980-95	18-2229	18-2230	18-2231	—	—
150	1979-95	18-2229	18-2230	18-2231	—	—
150C	1986-91,95	18-2229	18-2230	18-2231	—	—
155C	1984-87,89-95	18-2229	18-2230	18-2231	—	—
175	1977	18-2229	18-2230	18-2231	—	—
175	1978-88,90-95	18-2229	18-2230	18-2231	—	—
185	1984-85,90-95	18-2229	18-2230	18-2231	—	—
200	1976-77	18-2229	18-2230	18-2231	—	—
200	1978-83,86-95	18-2229	18-2230	18-2231	—	—
200C	1990	18-2229	18-2230	18-2231	—	—
225	1986-93	18-2229	18-2230	18-2231	—	—
235	1978-85	18-2229	18-2230	18-2231	—	—
1600cc	1988	18-2229	18-2230	18-2231	—	—
2500cc	1988	18-2229	18-2230	18-2231	—	—

① Envase estándar 2 ② Incluye 1 cada uno 18-2229, 18-2230 & 18-2231

③ Precio por pieza. Para pedir envasado añadir -9 a la referencia

Zinc es sólo para aplicaciones en agua salada.
 Magnesio es sólo para aplicaciones en agua dulce.
 Aluminio es tanto para agua dulce como para agua salada.



③ 025757
ÁNODO
 Reemplaza: 433580
 Para: 60-225 (1991-93)



③ 009322
 ① 18-6017A
 ② 18-6100
ÁNODO
 Reemplaza: 173029, 123009
 (1981-91) 9.9-115 HP



009322
ÁNODO
 Reemplaza: 327606
 1983-89 2HP



③ 025339
 ① 18-6024A
ÁNODO
 Reemplaza: 393023, 436745
 (1982-87) 60-300 HP
 Para uso con caja engranajes



③ 18-6025
ÁNODO
 Reemplaza: 433458, 398331
 (1987-92) 60-300HP



② 009319
ÁNODO
 Reemplaza: 392462
 Para escape alojamiento,
 2 & 3 Cil. (1984-99)



③ 025756
 ① 18-6095A
ÁNODO
 Reemplaza: 431708
 (1988-90) 45-300 HP



③ 009368
ÁNODO
 Reemplaza: 976669
 (1969-89)
 Kit para V4 & V6



③ 009318
ÁNODO
 Reemplaza: 392123
 (1982-98) 40-300 HP

① Aluminio ② Magnesio ③ Zinc

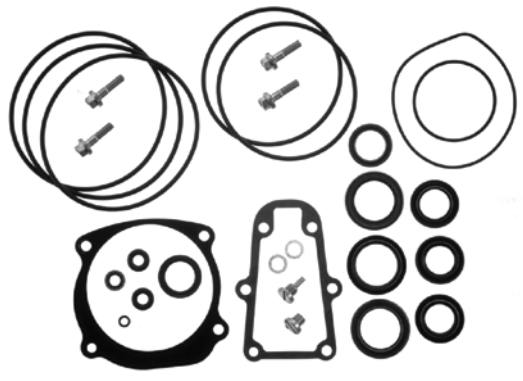

18-2623
KIT RETENES UNIDAD INFERIOR
 Reemplaza: 439141

— CONTIENE —

Ref #	Desc.	O.E. #	Cant.
18-0110	Junta	314082	1
18-2001	Retén	330137	2
18-2002	Retén	320862	2
18-2026	Retén	321453	2
18-2061	Retén	329922	1
18-2062	Retén	329923	1
18-2377	Tornillo	316563	4
18-2378	Tornillo drenaje magnético	318544	1
18-2536	Aro tórico	315788	1
18-2557	Junta impulsor	338484	1
18-4248	Arandela	311598	2
18-7109	Aro tórico	317178	1
18-7120	Aro tórico	307853	1
18-7127	Aro tórico	313446	1
18-7130	Aro tórico	314728	1
18-7133	Aro tórico	305123	2
18-7137	Aro tórico	318372	2
18-7142	Aro tórico	322119	1
18-7144	Aro tórico	333572	3
18-7145	Aro tórico	332584	1
18-7475	Arandela	328743	4
18-8300	Retén	341280	1
18-8301	Retén	341281	1

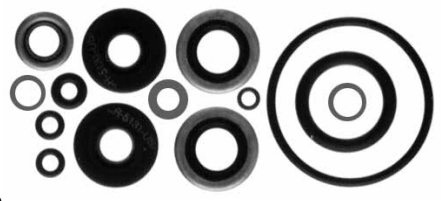

18-2656
KIT DE RETENES UNIDAD INFERIOR
 Reemplaza: 396350

18-2657
KIT RETENES UNIDAD INFERIOR
 Reemplaza: 396352

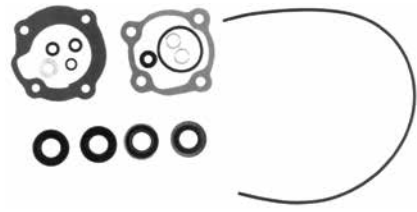

— CONTIENE —

Ref #	Desc.	O.E. #	Cant.
18-2025	Retén aceite	318971	1
18-2028	retén aceite	321480	2
18-2029	Retén aceite	321481	2
18-4248	Arandela	311598	2
18-7100	Aro tórico	301877	1
18-7104	Aro tórico	308627	1
18-7120	Aro tórico	307853, 322598	1
18-7139	Aro tórico	319085	1
18-7145	Aro tórico	333572	2

— CONTIENE —

Ref #	Desc.	O.E. #	Cant.
18-0882	Junta	304764	1
18-0108	Junta inferior caja engranajes	324449	1
18-3360	Junta alojamiento impulsor	329390	1
18-7411	Aro tórico	—	1
18-2027	Retén aceite	321459	2
18-2031	Retén aceite	321787	1
18-2063	Retén aceite	330327	1
18-4248	Arandela	311598	2
18-7100	Aro tórico	301877	1
18-7145	Aro tórico	333572	2
18-7475	Aro Quad	332583	1

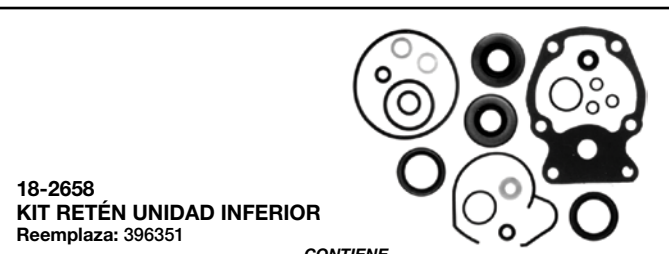

18-2658
KIT RETÉN UNIDAD INFERIOR
Reemplaza: 396351

- CONTIENE -

Ref #	Desc.	O.E. #	Cant.
18-0124	Junta impulsor platina	325537	1
18-2026	Retén aceite	321453	2
18-2033	Retén aceite	321928	1
18-2065	Retén aceite	332261	1
18-2539	Retén goma	328753	1
18-4248	Arandela	311598	2
18-7100	Aro tórico	301877	1
18-7105	Aro tórico	311338	2
18-7108	Aro tórico	313893	1
18-7109	Aro tórico	317178	3
18-7145	Aro tórico	333572	2
18-7146	Aro tórico	554545	1
18-7180	Aro tórico	303347	1
18-2030	Retén aceite	321786	1
18-2027	Retén aceite	321459	1

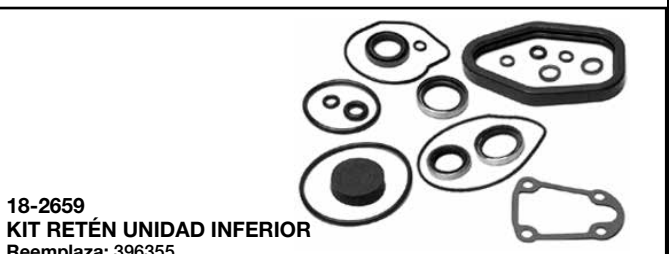

18-2659
KIT RETÉN UNIDAD INFERIOR
Reemplaza: 396355

- CONTIENE -

Ref #	Desc.	O.E. #	Cant.
18-0969	Junta impulsor alojamiento	319586	1
18-2059	Retén aceite	321466	1
18-2060	Retén aceite	321467	2
18-2064	Retén aceite	332205	1
18-2532	Retén	305762	1
18-2537	Retén goma	324937	1
18-2855	Junta tapa	314082	1
18-4248	Arandela	311598	2
18-7115	Aro tórico	302588	1
18-7120	Aro tórico	307853	1
18-7137	Aro tórico	318372	1
18-7140	Aro tórico	320303	1
18-7145	Aro tórico	333572	2
18-7475	Aro quad	332584	3



18-2660
KIT RETÉN UNIDAD INFERIOR
Reemplaza: 396349

- CONTIENE -

Ref #	Desc.	O.E. #	Cant.
18-2059	Retén aceite	321466	1
18-2064	Retén aceite	332205	1
18-2537	Retén goma	324937	1
18-2855	Junta tapa	314082	1
18-4248	Arandela	311598	2
18-7120	Aro tórico	307853	1
18-7127	Aro tórico	313446	1
18-7128	Aro tórico	313754	1
18-7137	Aro tórico	318372	1
18-7145	Aro tórico	333572	2
18-7475	Aro quad	332584	4
18-7174	Aro tórico	910582, 326649	1
18-2001	Retén aceite	330137	2

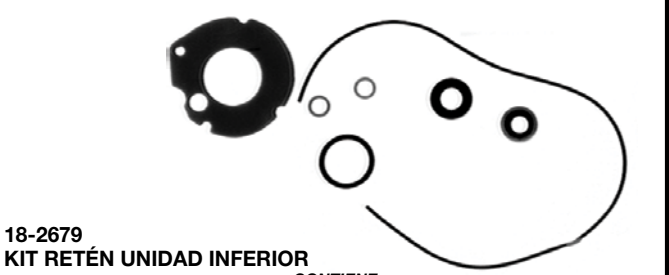

18-2679
KIT RETÉN UNIDAD INFERIOR

- CONTIENE -

Ref #	Desc.	O.E. #	Cant.
18-2022	Retén aceite	303345	1
18-2035	Retén aceite	327031	1
18-2891	Junta alojamiento cojinete	303339	1
18-4248	Arandela	311598	2
18-7100	Aro tórico	301877	1
18-7117	Aro tórico	303360	1
18-7120	Aro tórico	307853	1
18-2534	Retén	309044	1

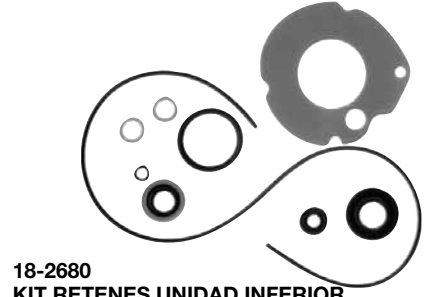

18-2680
KIT RETENES UNIDAD INFERIOR

- CONTIENE -

Ref #	Desc.	O.E. #	Cant.
18-2023	Retén aceite	313282	1
18-2035	Retén aceite	327031	1
18-2891	Junta alojamiento cojinete	303339	1
18-4248	Arandela	311598	2
18-7100	Aro tórico	301877	1
18-7117	Aro tórico	303360	1
18-7120	Aro tórico	307853	1
18-2534	Retén	309044	1



18-2681
KIT RETENES UNIDAD INFERIOR

- CONTIENE -

Ref #	Desc.	O.E. #	Cant.
18-2023	Retén aceite	313282	1
18-2024	Retén aceite	314167	1
18-2891	Junta alojamiento cojinete	303339	1
18-4248	Arandela	311598	2
18-7100	Aro tórico	301877	1
18-7117	Aro tórico	303360	1
18-7120	Aro tórico	307853	1
18-2534	Retén	309044	1

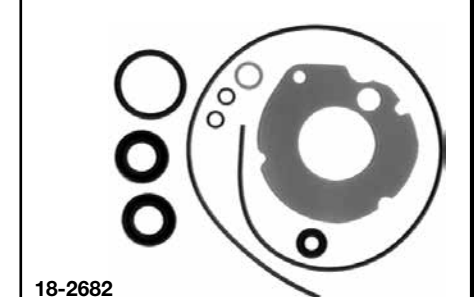

18-2682
KIT RETENES UNIDAD INFERIOR

- CONTIENE -

Ref #	Desc.	O.E. #	Cant.
18-2022	Retén aceite	303345	2
18-2891	Junta alojamiento cojinete	303339	1
18-4248	Arandela	311598	2
18-7100	Aro tórico	301877	1
18-7117	Aro tórico	303360	1
18-7120	Aro tórico	307853	1
18-2534	Retén	309044	1



18-2683
KIT RETENES UNIDAD INFERIOR

- CONTIENE -

Ref #	Desc.	O.E. #	Cant.
18-2023	Retén aceite	313282	2
18-2891	Junta alojamiento cojinete	303339	1
18-4248	Arandela	311598	2
18-7100	Aro tórico	301877	1
18-7117	Aro tórico	303360	1
18-7120	Aro tórico	307853	1
18-2534	Retén	309044	1



18-2684
KIT RETÉN UNIDAD INFERIOR

- CONTIENE -

Ref #	Desc.	O.E. #	Cant.
18-0882	Junta	304764	1
18-2032	Retén aceite	321788	1
18-4248	Arandela	311598	2
18-7100	Aro tórico	301877	1
18-7120	Aro tórico	307853	1
18-2031	Retén aceite	321787	1
18-2534	Retén	309044	1



18-2685
KIT RETÉN UNIDAD INFERIOR

- CONTIENE -

Ref #	Desc.	O.E. #	Cant.
18-2030	Retén aceite	321786	3
18-2031	Retén aceite	321787	1
18-4248	Arandela	311598	2
18-7100	Aro tórico	301877	1
18-7112	Aro tórico	302493	1
18-7120	Aro tórico	307853	1
18-2534	Retén	309044	1
18-0882	Junta	304764	1



18-2686
KIT RETÉN UNIDAD INFERIOR

— CONTIENE —

Ref #	Desc.	O.E. #	Cant.
18-0882	Junta	304764	1
18-2005	Retén aceite	313284	1
18-2021	Retén aceite	302564	1
18-4248	Arandela	311598	2
18-7100	Aro tórico	301877	1
18-7115	Aro tórico	302588	1
18-7120	Aro tórico	307853, 322598	1



18-2687
KIT RETÉN UNIDAD INFERIOR

— CONTIENE —

Ref #	Desc.	O.E. #	Cant.
18-2005	Retén aceite	313284	1
18-4248	arandela	311598	2
18-7120	Aro tórico	307853, 322598	1
18-7152	Aro tórico	307082	1
18-2027	Retén aceite	321459	1
18-7143	Aro tórico	322501	1
18-0173	Retén aceite	313283	1
18-7428	Retén goma	307103	1



18-2688
KIT RETÉN UNIDAD INFERIOR

— CONTIENE —

Ref #	Desc.	O.E. #	Cant.
18-2027	Retén aceite	321459	2
18-2855	Junta alojamiento	314082	1
18-4248	Arandela	311598	2
18-7100	Aro tórico	301877	1
18-7109	Aro tórico	317178	4
18-7127	Aro tórico	313446	1
18-7128	Aro tórico	313754	1
18-2001	Retén aceite	330137	2
18-7129	Aro tórico	314491	1

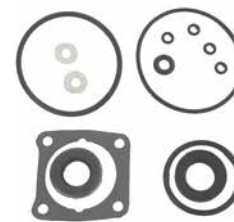

18-2689
KIT RETÉN UNIDAD INFERIOR

— CONTIENE —

Ref #	Desc.	O.E. #	Cant.
18-0173	Retén aceite	313283	1
18-0174	Retén aceite	326716	1
18-0886	Junta alojamiento	307099	1
18-4248	Arandela	311598	2
18-7115	Aro tórico	302588	1
18-7118	Aro tórico	305242	1
18-7120	Aro tórico	307853, 322598	4
18-7152	Aro tórico	307082	1
18-7428	Aro tórico	307103	1

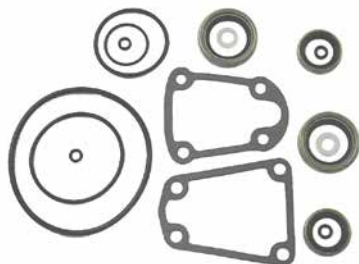

18-2690
KIT RETÉN UNIDAD INFERIOR

— CONTIENE —

Ref #	Desc.	O.E. #	Cant.
18-2855	Junta alojamiento	314082	1
18-2874	Junta tapa solenoide	314876	1
18-4248	Arandela	311598	2
18-7120	Aro tórico	307853, 322598	4
18-7127	Aro tórico	313446	1
18-7129	Aro tórico	314491	1
18-7130	Aro tórico	314728	1
18-7126	Aro tórico	313340	1

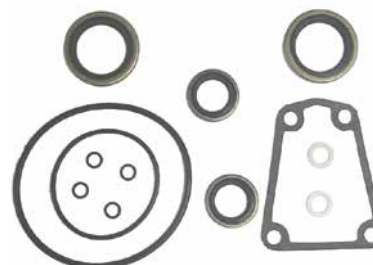

18-2691
KIT RETÉN UNIDAD INFERIOR

— CONTIENE —

Ref #	Desc.	O.E. #	Cant.
18-2874	Junta tapa solenoide	314876	1
18-4248	Arandela	311598	2
18-7109	Aro tórico	317178	4
18-7127	Aro tórico	313446	1
18-2001	Retén aceite	330137	2
18-7130	Aro tórico	314728	1
18-2059	Retén aceite	321466	2

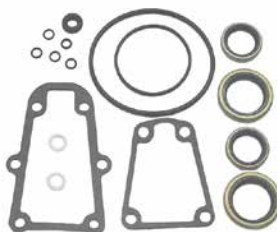

18-2692
KIT RETÉN UNIDAD INFERIOR

— CONTIENE —

Ref #	Desc.	O.E. #	Cant.
18-0110	Junta alojamiento	324670	1
18-2026	Retén aceite	321453	2
18-2874	Junta tapa solenoide	314876	1
18-4248	Arandela	311598	2
18-7109	Aro tórico	317178	4
18-7120	Aro tórico	322598	1
18-7127	Aro tórico	313446	1
18-7130	Aro tórico	314728	1
18-7137	Aro tórico	318372	1
18-2001	Retén aceite	330137	2



18-2694
KIT RETÉN UNIDAD INFERIOR
Reemplaza: 433550

— CONTIENE —

Ref #	Desc.	O.E. #	Cant.	Ref #	Desc.	O.E. #	Cant.
18-2709	Junta platina desgaste	336530	1	18-7481	Retén	315788	1
18-7115	Aro tórico	302588	1	18-2708	Retén	333758	1
18-7127	Aro tórico	313446	1	18-2059	Retén aceite	321466	2
18-7120	Aro tórico	307853, 322598	1	18-2018	Retén aceite	0767970	2
18-7172	Aro tórico	553126	1	18-2064	Retén aceite	332205	1
18-7137	Aro tórico	318372	1	18-2705	Retén	315748	1
18-7475	Aro tórico	332584	1	18-4248	Arandela	311598	1
				18-7173	Aro tórico	310327, 910582	1



18-8383
KIT RETENES
 Reemplaza: 5000309
 Para: E-Tec 40, 50, 60 HP



18-8384
KIT RETENES
 Reemplaza: E-Tec
 5006373
 Para: E-Tec 75/90/115/150/175/200/225/250 HP



18-8387
KIT RETENES UNIDAD INFERIOR
 Reemplaza: 5007987
 Para: E-Tec 15, 25, 30 (2010 & sup)



18-8337
KIT RETENES UNIDAD INFERIOR
 Reemplaza: 5031456
 Para: 40/50 HP 4 tiempos (1999-2003)
 — CONTIENE —

Ref #	Desc.	O.E. #	Cant.
18-0461	Junta bomba agua	—	1
18-7151	Aro tórico	—	1
18-7413	Aro tórico	303191	2
18-8331	Junta	—	3
18-8334	Retén	—	1
18-8345	Retén	—	2



18-74108
KIT RETÉN ALOJAMIENTO ENGR.
 Reemplaza: 5030973
 Para: Johnson Evinrude 60/70 4-Tiempos

APLICACIÓN KITS RETENES CADA DE CAMBIO

Modelo	Año	kit retén	Modelo	Año	Kit retén		
5.5	⑧	1955-67	18-2679	85	1991-95	18-2623	
6	⑧	1955-67	18-2679	88	1985-sup	18-2623	
6	⑨	1967-68	18-2680	90 (Elect.)	1964-65	18-2689	
6	⑩	1968-79	18-2681	90 (V-4)	1973-83	18-2692	
7.5	⑧	1955-67	18-2679	90	1985-sup	18-2623	
9.5 (Sufijo M)		1964-67	18-2682	100 (eje largo)	1971-72	18-2691	
9.5 (Sufijo B)		1967-73	18-2683	100 (V-4)		1973-83	18-2692
9.9/15		1974-Sup	18-2656	100 (Comm)		1984-90	18-2623
9.9/15 (4 tiempos)		1974-Sup	18-2656	100 (Comm)		1991-95	18-2623
10		1958-67	18-2682	100	③	1991-92	18-2623
18		1958-73	18-2684	110 (V-4)		1973-83	18-2692
20		1966-73	18-2684	110		1985-89	18-2623
20		1979-82	18-2684	115 (eje corto)	1969-71	18-2690	
20		1985-Sup	18-2658	115 (V-4)		1973-83	18-2692
25		1955-59	18-2686	115		1985-Sup	18-2623
25		1968-78	18-2684	120		1985	18-2623
25		1979-82	18-2685	120		1986-92	18-2623
25		1984	18-2657	120		1993	18-2623
25		1985-Sup	18-2658	125 (eje largo)		1971-72	18-2691
25	①	1990-95	18-2694	125	④	1991-92	18-2623
25 (Comm)		1985-Sup	18-2657	125		1993	18-2623
28		1962-70	18-2686	125 (Comm)		1991-93	18-2623
28		1985-98	18-2657	135 (V-4)		1973-83	18-2692
30		1955-59	18-2686	140 (V-4)		1973-83	18-2692
30		1976-95	18-2658	140		1985	18-2623
33		1962-70	18-2686	140	⑤	1986-92	18-2623
35		1955-59	18-2686	140	⑥	1992-93	18-2623
35		1977-92	18-2658	140	⑦	1992-95	18-2623
40 (cambio manual)		1960-73	18-2686	150 (V-6)		1978-86	18-2623
40 (cambio eléctrico)		1962-70	18-2687	150	⑦	1991	18-2623
40		1976-88	18-2659	150		1991-95	18-2623
40		1989-Sup	18-2694	155 (Comm)		1984-90	18-2623
48		1976-88	18-2659	155 (Comm)		1991-93	18-2623
48		1989-96	18-2694	175 (V-6)		1977-86	18-2623
50		1971-74	18-2688	175	②	1991	18-2623
50		1976-88	18-2659	175	⑦	1992	18-2623
50		1989-Sup	18-2694	175		1991-95	18-2623
50 (3 cil.)		1995-Sup	18-2660	185		1991-93	18-2623
55		1968-69	18-2690	200 (V-6)		1976-86	18-2623
55		1976-88	18-2659	200		1991-95	18-2623
60 (Manual/Elect.)		1960-68	18-2689	225		1991-95	18-2623
60		1970-71	18-2690	235 (V-6)		1977-86	18-2623
60 (2 cil.)		1976-88	18-2659	V-8	⑦	1985-91	18-2623
60 (3 cil.)		1978-Sup	18-2660	250 (V-8)		1991-95	18-2623
65 (Manual/Elect.)		1960-68	18-2689	300 (V-8)		1991-95	18-2623
65		1978-Sup	18-2660				
70		1978-Sup	18-2660				
75 (Manual/Elect.)		1960-68	18-2689				
75		1978-91	18-2660				
75 (Caja engranajes)		1976-88	18-2659				
V-4		1978-84	18-2623				
85 (Manual/Elect.)		1968	18-2689				
85 (Eje pequeño)	1969-71	18-2690					
85 (Eje largo)	1971-72	18-2691					
85 (V-4)		1973-83	18-2692				

- ① Sólo sufijos "D"
- ② Sólo modelos "GL" & "EX"
- ③ Modelos 1992 excepto WTLNE, WTXENE
- ④ Sólo modelos 1992 ESX
- ⑤ Sólo modelos 1992 TL
- ⑥ Solo modelos CX
- ⑦ 1992 Contra rotación
- ⑧ 1967 sólo sufijo "D"
- ⑨ 1967 sólo sufijo "S"
1968 sólo sufijo "C"
- ⑩ 1968 sólo sufijos "A" & "R"
- Modelos TX y contra la rotación



18-2595
JUEGO DE JUNTAS
 Reemplaza: 982132

18-2595 APLICACIÓN DE JUEGO DE JUNTAS

HP	AÑOS	HP	AÑOS	HP	AÑOS
85	1978-80	120	1985-90	200	1976-90
88	1987-90	125	1989-90	225	1986-90
90	1981-90	140	1977-90	235	1978-85
100	1979-90	150	1978-90	275	1985-90
100C	1984-89	155C	1984-90	3.6L	1985-90
110	1986-89	175	1977-90	300	1985-90
115	1978-90	185	1984-90		

RETÉN ACEITE



Ref #	O.E. #	Medida eje	Dimensiones (pulg)		Ref #	O.E. #	Medida eje	Dimensiones (pulg)	
			D.E.	Ancho				D.E.	Ancho
18-0173	313283	0.795	1.320	0.307	18-2059	321466	0.750	1.126	0.200
18-0174	326716	0.750	1.382	0.242	18-2060	321467	1.000	1.375	0.250
18-0542	321831, 315288	0.750	1.253	0.186	18-2061	329922	0.822	1.375	0.195
18-0543	321895,	1.540	1.926	0.243	18-2062	329923	0.875	1.375	0.207
	313507				18-2063	330327	0.625	1.124	0.188
18-0559	332585	0.285	0.357	0.940	18-2064	332205	0.730	1.130	0.194
18-2000	309989	1.375	2.000	0.313	18-2065	332261	0.625	1.375	0.195
18-2001	330137	1.125	1.624	0.250	18-2066	911019	1.000	1.375	0.435
18-2002	320862	1.188	1.692	0.250	18-2067	911685	2.000	2.509	0.315
18-2005	313284	0.625	1.128	0.250	18-2068	911701	0.500	0.905	0.250
18-2012	310599	1.000	1.499	0.250	18-2068	915702	0.500	0.905	0.250
18-2016	313992	1.187	1.875	0.250	18-2068	916058	0.500	0.905	0.250
18-2018	305987	1.000	1.375	0.250	18-2068	3853655	.500	.905	.250
18-2020	310649	2.500	3.000	0.250	18-2071	981195	1.500	2.125	0.250
18-2021	302564	0.750	1.375	0.250	18-2072	981196	1.750	2.502	0.250
18-2022	303345	0.554	1.000	0.375	18-2073	981268	1.625	2.502	0.250
18-2023	313282	0.554	1.062	0.312	18-2074	339620	1.625	2.125	0.250
18-2024	314167	0.425	0.937	0.312	18-2075	0353076	1.562	2.062	0.300
18-2025	318972	0.500	0.875	0.250	18-8300	341280	0.866	1.378	0.280
18-2026	321453	0.875	1.250	0.188	18-8301	341281	1.220	1.693	0.280
18-2027	321459	0.625	1.125	0.250	18-8304	321830	20.37mm	31.8mm	6.35mm
18-2028	318973	0.500	1.250	0.188	18-8307	331103	1.100	1.628	0.448
18-2029	321481	0.687	1.250	0.250	18-8325	342786	28mm	41.5mm	7/11
18-2030	321786	0.625	1.125	0.188	18-8326	342787	18mm	29mm	8/12
18-2031	321787	0.625	1.125	0.312		911795			
18-2032	321788	0.500	1.000	0.188	18-8349	3852548	1.375	2.186	0.500
18-2033	321928	0.625	1.375	0.250	18-8350	328603	1.100	1.690	0.320
18-2034	324639	0.437	0.937	0.188	18-8351	321504, 308500	1.110	1.570	0.320
18-2035	327031	0.425	0.875	0.313	18-8367	334950	1.250	1.687	0.250
18-2058	313353	1.938	2.438	0.250					

APLICACIÓN RETÉN ACEITE

HP	AÑOS	EJE HÉLICE	CANT.	EJE TRANSMISIÓN	CANT.	CÁRTER SUPERIOR	CANT.	CÁRTER SUPERIOR	CANT.
1.5,2,2.5,3	1958-68	-	1	18-2035	1	-	-	-	-
1.5,2	1968-90	18-2035	1	18-2035	1	-	-	-	-
2.5,4	② 1973-80	18-2035	1	18-2035	2	-	-	-	-
2.5	1987	18-2034	2	18-2035	2	-	-	-	-
2.5,4	② 1981-95	-	1	18-2035	2	-	-	-	-
3 Weedless	1958-68	18-2035	1	-	-	-	-	-	-
3,4,6 Weedless	1968-82	18-2024	1	18-2024	1	-	-	-	-
4	1981-90	18-2034	2	-	-	-	-	-	-
4	1984, 1986-95	-	-	18-2034	2	-	-	-	-
4.5,7.5	1980-87	-	1	18-2034	2	-	-	-	-
5.5,5.6,7.5	① 1957-64	18-2022	1	18-2035	1	-	-	-	-
5.6,8	1980-87	-	-	18-2034	2	-	-	-	-
6	1965-67	-	1	18-2023	1	-	-	-	-
6	1968-79	18-2023	1	18-2024	1	-	-	-	-
9.5	1964-73	18-2022	1	18-2022	1	-	-	-	-
9.9	1974-83	18-2029	1	18-2028	1	18-8304	-	18-0542	1
9.9	1984-95	18-2029	1	18-2028	1	18-8304	-	18-0542+18-2032	1
10	1957-58	18-2005	1	18-2032	1	-	-	-	-
10	1959-63	18-2022	1	18-2022	1	-	-	-	-

① 1968 Modelos 5802M,3M,6802C,3C

② Caja de engranajes estándar

APLICACIONES RETÉN ACEITE (Cont.)

HP	AÑOS	EJE HÉLICE	CANT.	EJE HÉLICE	CANT.	PARTE SUP. CIGÜENAL	CANT.	PARTE SUP. CIGÜENAL	CANT.
10	1981	18-2023 (interior)	1	-	-	18-8304	-	18-0542	1
10	1989	18-2031+18-2027	1	18-2063+18-2027	1	18-8304	-	18-0542+18-2032	1
14	1988-90	18-2031+18-2027	1	18-2063+18-2027	1	18-8304	-	18-0542+18-2032	1
15	1974-83	18-2029	2	18-2028	1	18-8304	-	18-0542	1
15	1984-95	18-2029	2	18-2028	1	18-8304	-	18-0542+18-2032	1
18	1957	18-2005	1	18-2032	1	18-2060	1	-	-
18	1958-73	18-2005	1	18-2032	1	18-2018	1	-	-
20	1981-82	18-2031+18-2030	1	18-2030	1	18-8351	-	-	-
20	1983	18-2031+18-2030	1	18-2027+18-2030	1	18-8351	-	-	-
20	1984	18-2025+18-2027	1	18-2063+18-2030	1	18-8351	-	-	-
20	1985-86	18-2026	1	18-2033	1	18-8350	-	-	-
20	1987-95	18-2026	1	18-2033+18-2065	1	18-8350	-	-	-
25	1969-76	18-2005	1	18-2032	1	18-2018	1	-	-
25	1977-78	18-2005	1	18-2032	1	18-8351	-	-	-
25	1979-82	18-2031+18-2030	1	18-2030	1	18-8351	-	-	-
25	1983	18-2031+18-2030	1	18-2027+18-2030	1	18-8351	-	-	-
25	1984	18-2031+18-2027	1	18-2063+18-2030	1	18-8351	-	-	-
25	1985-86	18-2026	1	18-2033	2	18-8351	-	-	-
25	1987-95	18-2026	1	18-2033+18-2065	1	18-8351	-	-	-
25C	1982	18-2030	1	18-2030	1	18-8351	-	-	-
25C	1983	18-2031+18-2027	1	18-2027+18-2030	1	18-8350	-	-	-
25C	1984-90	18-2031+18-2027	1	18-2063+18-2027	1	18-8350	-	-	-
28	1962-64	18-2021	1	18-2005	1	18-8351	-	-	-
28	1987-90	18-2031+18-2027	1	18-2063+18-2027	1	18-8350	-	-	-
30	1984-86	18-2026	1	18-2033	1	18-8350	-	-	-
30	1987-95	18-2026	1	18-2033 (interior)	1	18-8350	-	-	-
33	1965-76	18-2021	1	18-2005	1	18-8351	-	-	-
35	1957-59	18-2021	1	18-2005	1	18-2018	1	-	-
35	1976	18-2026	1	18-2027	2	18-8351	-	-	-
35	1977-86	18-2026	2	18-2033	2	18-8351	-	18-2093	-
35	1987-90	18-2026	2	18-2033 (interior)	1	18-8350	-	18-2093	-
40	1960-61	18-2021	1	18-2005	1	18-2018	1	-	-
40	1962-73	18-2021	1	18-2005	1	18-8351	-	-	-
40	1974-76	18-2021	1	18-2029	1	18-0543	1	18-2001	1
40C	1981-86	18-2021	1	18-2029	2	18-0543	1	18-2001	2
40	1984-85	18-2060	2	18-2059	2	18-0543	1	18-2001	1
40 (AR,AE,AT)	1988	18-2001	1	18-2063+18-2027	1	18-0543	1	18-8307	-
40	1986-89	18-2060	2	18-2064+18-2059	1	18-0543	1	18-8307	-
45C	1985	18-2001	2	18-2063+18-2027	1	18-0543	1	18-8307	-
45C	1986	18-2001	2	18-2064+18-2059	1	18-0543	1	18-8307	-
45C	1987	18-2001	2	18-2063+18-2027	1	18-0543	1	18-8307	-
45C	1988-94	18-2001	2	18-2063+18-2027	1	18-0543	1	18-2001	-
45C	1995	18-2001	2	18-2064+18-2059	1	18-0543	1	-	-
48	1988-95	18-2060	2	18-2064+18-2059	1	18-0543	1	18-2063 (interior)	1
50	1971-74	18-2001 (Manual)	2	18-2027	2	18-0543	1	18-2001	1
50	1975	18-2060	2	18-2059	1	18-0543	1	18-2001	1
50	1979	18-2001	2	18-2027	2	18-0543	1	18-2001	1
50	1980	18-2060	2	18-2059	1	18-0543	1	18-2001	1
50/60 (arranq.man)	1981-83	18-2001	2	18-2027	1	18-0543	1	18-2001	1
50/60 (Electrico)	1981-83	18-2060	2	18-2059	1	18-0543	1	18-2001	1
50/60	1984-85	18-2060	2	18-2059	1	18-0543	1	18-2001	1
50/60 caja engr. pequeña	1986-87	18-2060	2	18-2064+18-2059	1	18-0543	1	18-2001	1
50/60 caja eng.grande	1986-87	18-2001	2	18-2064+18-2059	1	18-0543	1	18-2001	1
50/60	1988-89	18-2001	2	18-2064+18-2059	1	18-0543	1	18-2001	1
50	1990-95	18-2060	2	18-2064+18-2059	1	18-0543	1	18-2063 (interior)	1
55	1968-69	18-2012	2	18-2059	2	18-0543	1	18-2001	1
55	1976-77	18-2060	2	18-2059	2	18-0543	1	18-2001	1
55	1978	18-2059	1	18-2059	2	18-0543	1	18-2001	1
55	1979-83	18-2001	2	18-2027	1	18-0543	1	18-2001	1
55 (Electrico)	1980-83	18-2012	2	18-2059	2	18-0543	1	18-2001	1
55C	1984	18-2001	2	18-2063+18-2027	1	18-0543	1	18-2001	1
55C	1985	18-2001	2	18-2063	1	18-0543	1	18-2001	1
55C	1986	18-2001	2	18-2064+18-2059	1	18-0543	1	18-8307	-
55C	1987-94	18-2001	2	18-2063+18-2027	1	18-0543	1	18-8307	-
55C	1995	18-2001	2	18-2064+18-2059	1	18-0543	1	-	-
60 (Manual Shift)	1964-68	18-0173	1	18-0174	1	-	-	-	-
60	1970	18-2012	1	18-2059	2	18-0543	1	18-2001	1
60 (3 Cilindro)	1971	18-2001	2	18-2059	2	18-0543	1	18-2001	1
60 (manual)	1980-83	18-2001	2	18-2027	2	18-0543	1	18-2001	1

FUERABORDA – JOHNSON/EVINRUDE (OMC/BRP) - Retén aceite

APLICACIÓN RETÉN ACEITE (Cont.)

HP	AÑOS	EJE HÉLICE	CANT.	EJE TRANSMISIÓN	CANT.	PARTE SUP. CIGÜEÑAL	CANT.	PARTE. INF. CIGÜEÑAL	CANT.
60 (Electrico)	1980-83	18-2001	2	18-2059	2	18-0543	1	18-2001	1
60	1984-85	18-2060	2	18-2059	2	18-0543	1	18-2001	1
60SST	1989	18-2060	2	18-2064+18-2059	1	18-0543	1	18-2001	1
60SST	1990	18-2060	2	18-2064+18-2059	1	18-0543	1	18-8307	-
60 (3 Cilindros)	1987-95	18-2001	2	18-2064+18-2059	1	18-0543	1	18-8307	-
65 (Manual)	1968	18-0173	1	18-0174	1	18-0543	1	-	-
65 (3 Cilindros)	1972-73	18-2001	2	18-2059	2	18-0543	1	18-2001	1
65C	1984-85	18-2001	2	18-2059	2	18-0543	1	18-2001	1
65C	1986-89	18-2001	2	18-2064+18-2059	1	18-0543	1	18-2001	1
70 (caja engr. grande)	1974-85	18-2001	2	18-2059	2	18-0543	1	18-2001	1
70 (Caja engr. grande)	1986-95	18-2001	2	18-2064+18-2059	1	18-0543	1	18-8307	-
70 Caja engr. pequeña)	1977-85	18-2060	2	18-2059	2	18-0543	1	18-8307	-
75 (Manual)	1960-62	18-0173	1	18-0174	1	-	-	-	-
75 (caja engr. grande)	1975-84	18-2001	2	18-2059	2	18-0543	1	18-2001	1
75 (caja engr. grande)	1986-87	18-2001	2	18-2064+18-2059	1	18-0543	1	18-8307	-
75 (caja engr. pequeña)	1975-84	18-2060	2	18-2059	2	18-0543	1	18-2001	1
80	1966-68	18-0173	1	18-0174	1	-	-	-	-
85	1969-70	18-2012	2	18-2059	2	18-2074	1	18-2001	1
85	1971-72	18-2001	2	18-2059	2	18-2074	1	18-2001	1
85	1973-80	18-2001	2	18-2026	2	18-2074	2	18-2001	1
88	1987-94	18-2001	2	18-2061+18-2062	1	18-2074	2	18-8307	-
90	1981-83	18-2001	2	18-2026	2	18-2074	2	18-2001	1
90	1984-94	18-2001	2	18-2061+18-2062	1	18-2062	1	18-8307	-
90 Seadrive	1985-90	18-2001	2	18-2061+18-2062	1	18-2074	2	18-2001	1
100	1971-72	18-2001	2	18-2059	2	18-2074	1	18-2001	1
100	1979-80	18-2001	2	18-2026	2	18-2074	2	18-2001	1
100C	1984-90	18-2002	2	18-2061+18-2062	1	18-2074	2	18-8307	-
110	1986-88	18-2001	2	18-2061+18-2062	1	18-2074	2	18-2001	1
115	1969-70	18-2012	2	18-2059	2	18-2074	1	18-2001	1
115	1973-83	18-2001	2	18-2026	2	18-2074	1	18-2001	1
115	1984-85	18-2001	2	18-2061+18-2062	1	18-2074	2	18-2001	1
115	1990-94	18-2001	2	18-2061+18-2062	1	18-2074	2	18-8307	-
120	1985	18-2002	2	18-2061+18-2062	1	18-2074	2	18-2075	2
120	1986-88	18-2001	2	18-2061+18-2062	1	18-2074	2	18-2075	2
120	1989	18-2002	2	18-2061+18-2062	1	18-2074	2	18-2075	2
120	1990-94	18-2001	2	18-2061+18-2062	1	18-2074	2	18-2075	2
125	1971-72	18-2001	2	18-2059	2	18-2074	1	18-2001	1
125C	1989	18-2002	2	18-2061+18-2062	1	18-2074	2	18-2075	1
125C (ESX modelos)	1989	18-2001	2	18-2061	1	18-2062	1	18-2075	1
135	1973-76	18-2001	2	18-2026	2	18-2074	2	18-2001	1
140	1977-83	18-2001	2	18-2026	2	18-2074	2	18-2001	1
140	1984	18-2001	2	18-2026	2	18-2074	2	18-2001	1
140	1985	18-2002	2	18-2061+18-2062	1	18-2074	2	18-2075	2
140	1986-94	18-2001	2	18-2061+18-2062	1	18-2074	2	18-2075	2
140TX	1989	18-2002	1	18-2061+18-2061	1	18-2074	2	18-2075	2
150	1978-83	18-2002	2	18-2026	2	18-2074	2	18-2075	2
150	1984	18-2002	2	18-2061+18-2062	1	18-2074	2	18-2075	2
150	1985-90	18-2002	2	18-2061+18-2062	1	18-2074	2	18-8307	-
155C	1984-85	18-2002	2	18-2061+18-2062	1	18-2074	2	18-2001	1
155C	1986-90	18-2002	2	18-2061+18-2062	1	18-2074	2	18-8307	-
175	1977-85	18-2002	2	18-2026	2	18-2074	2	18-2001	1
175	1986-90	18-2002	2	18-2061+18-2062	1	18-2074	2	18-8307	-
185	1984-85	18-2002	2	18-2061+18-2062	1	18-2074	2	18-2001	1
185	1990	18-2002	2	18-2061+18-2062	1	18-2074	2	18-2075	1
200	1976-83	18-2002	2	18-2026	2	18-2074	2	18-2001	1
200	1984-85	18-2002	2	18-2061+18-2062	1	18-2074	2	18-8307	-
200,225	1986-90	18-2002	2	18-2061+18-2062	1	18-2074	2	18-2075	2
235	1978-83	18-2002	2	18-2026	2	18-2074	2	18-2001	1
235	1984-85	18-2002	2	18-2061+18-2062	1	18-2074	2	18-2001	1
275	1985-88	18-2002	2	18-2061+18-2062	1	18-2074	2	18-2075	2

APLICACIÓN RETÉN ACEITE - ALOJAMIENTO EJE TRANSMISIÓN

HP	Años	Sierra Retén aceite	Cant.	Desc.	HP	Años	Sierra Retén aceite	Cant.	Desc.
5/6/6.5/8 ①	1987-90	18-2034	1	EH,L	75/80/85	1961-68	18-2060	1	PS
45/55 ①	1990	18-2063	1	EH A	90/100	1964-68	18-2060	1	PS
50/60/65	1958-68	18-2060	1	PS					

① También modelos comerciales
PS Pivote

EH A Alojamiento escape a adaptador
EH,L Eje transmisión a alojamiento de escape

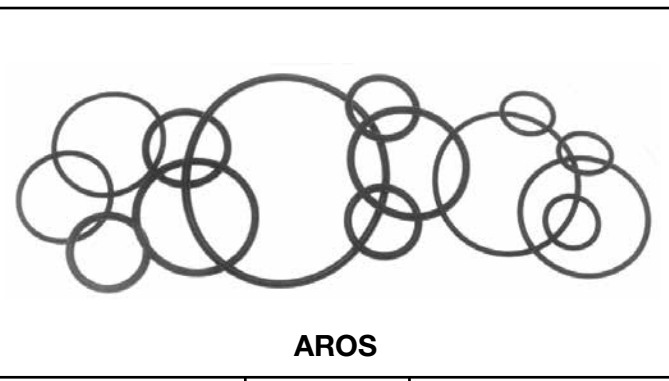

AROS

Ref #	O.E. #	Dimensiones (pulg)	
		D.I.	Ancho
18-7100 ②⑤	301877	.245	.155
18-7101 ②⑤	305739	.250	.065
18-7102 ②⑤	307450	.430	.065
18-7103 ②⑤	308624	.924	.103
18-7104 ②⑤	308627	2.210	.135
18-7105 ②⑤	311338	.750	.065
18-7107 ②⑤	313175	4.750	.135
18-7108 ②⑤	313893	2.550	.100
18-7108 ②⑤	338518	2.550	.100
18-7109 ②⑤	317178	.214	.048
18-7111 ①	301824	.197	.113
18-7112 ①	302493	1.170	.135
18-7114 ②	302540	1.000	.135
18-7115 ①	302588	1.735	.135
18-7116 ①	303067	.360	.100
18-7117 ①	303360	1.060	.135
18-7118 ②⑤	305242	.300	.135
18-7120 ①	307853	.215	.065
18-7121 ①	308621	3.100	.135
18-7123 ①	308876	2.235	.100
18-7126 ①	313340	1.690	.100
18-7127 ①	313446	3.315	.135
18-7128 ①	313754	1.835	.100
18-7129 ②⑤	314491	.970	.065
18-7130 ①	314728	2.125	.100
18-7133 ②⑤	305123	3.780	.135
18-7133 ②⑤	322119	3.780	.135
18-7134 ②⑤	303059	.500	.100
18-7135 ①	310584	.750	.135
18-7137 ②⑤	318372	0.320	.155
18-7138 ②⑤	318717	1.500	.210
18-7139 ②⑤	319085	1.080	.210
18-7140 ②⑤	320303	2.750	.135
18-7141 ②⑤	321117	.180	.065
18-7142 ②	322119,	3.940	.135
18-7143 ②⑤	322501, 331188	1.310	.100
18-7144 ②⑤	326849	4.250	.135
18-7145 ②⑤	333572	.250	.100
18-7146 ②⑤	554545	1.120	.100
18-7150 ③⑤	303598	.225	.115
18-7150 ③⑤	331380	.225	.115
18-7150 ③⑤	334913	.225	.115
18-7152 ②⑤	307082	2.625	.135
18-7153 ②⑤	911851	.862	.103
18-7153 ②⑤	3852565	.862	.103
18-7155 ②⑤	305270	1.620	.135
18-7156 ②⑤	309731	1.185	.100
18-7158 ②⑤	310967	.740	.100
18-7158 ②⑤	310585	.740	.100
18-7162 ②⑤	302337	2.025	.135
18-7164 ②⑤	302537	1.375	.100
18-7165 ②⑤	304174	.500	.065
18-7167 ②⑤	310414	3.625	.135
18-7168 ②⑤	202893	.370	.065
18-7169 ②⑤	911686	3.500	.135
18-7170 ②⑤	307239	1.359	.139
18-7172 ②⑤	553126	3.250	.135
18-7173 ②⑤	310327	1.875	.135
18-7174 ②⑤	910582	.620	.100
18-7174 ②⑤	326649	.620	.100
18-7178 ②⑤	320140	.920	.135
18-7180 ②⑤	303347	.445	.090
18-7198 ②⑤	308626	1.430	.100
18-7400 ②⑤	908194	4.000	.100
18-7401 ②⑤	908383	2.485	.100
18-7403 ②⑤	909316	1.500	.100
18-7404 ②⑤	909747	.300	.100
18-7406 ②⑤	911311	0.250	.065
18-7407 ②⑤	911700	4.125	.135
18-7407 ⑤	3852531	4.125	.135
18-7408 ②⑤	911718	1.060	.100
18-7409 ②⑤	911871	1.175	.100
18-7411 ②⑤	321921	1.237	.103
18-7413 ②⑤	303191	.301	.070
18-7416 ②⑤	329380	.612	.103
18-7417 ②⑤	329381	.362	.103
18-7418 ②⑤	326741	4.484	.139
18-7440-1 ④	301967	.799	.103
18-7457 ①	319662	1.799	.103
18-7461 ①	308458	1.612	.103
18-7475 ①⑤	332584	.250	.065
18-7477 ■ ②⑤	909048	.480	.100
18-7510 ⑤	321163	2.750	.070

① ENV. DE 1 ② ENV. DE 5 ③ ENV. DE 10 ④ ENV. DE 2 ■ Indica aros quad
 ⑤ Precio por pieza. Para pedir envasado añadir -9 a la referencia.

BLOQUE MOTOR

HP	AÑOS	AROS	CANT	DESC
5.5	1959	18-7180	1	L C
9.5	1964-73	18-7156	1	U C
18	1957-72	18-7114	1	CCH
18/25	1957-76	18-7164	1	LL C
20/25 ①	1977,79-90	18-7174	1	L C
20/25	1990-95	18-7146	1	CCH O
25/35	1957,69-76	18-7114	1	CCH
25/18	1971-76	18-7164	1	U C
25 ⑥	1989-90	18-7123	1	CCH
25 ⑥	1989-90	18-7457	1	U C
25/35	1978	18-7134	1	L C
28	1962-64	18-7164	1	LL C
28/30/35	1976-77,79-90	18-7174	1	L C
28/30/35	1990-95	18-7146	1	CCH O
33/35/40	1957-75	18-7164	1	LL C
35	1987	18-7128	1	U C
35	1987	18-7123	1	CCH
40/45 ①	1976,81-95	18-7123	1	CCH
40) ①	1976,81-95	18-7128	1	U C
45/45SS ①	1985-95	18-7128	1	U C
45SS/48	1987-95	18-7123	1	CCH
48/50/55 ①	1971-95	18-7128	1	U C
50	1958-59	18-7133	1	CCH
50/55 ①	1968-90	18-7123	1	CCH
55/60	1968-71	18-7117	1	CCH O
60/65/75/80	1960-68	18-7133	2	CCH
60/SST60	1970-71,81-95	18-7128	1	U C
60/SST60	1970-95	18-7123	1	CCH
60/SST60	1989-90	18-7158	1	L C
65 ①	1972-73,85-95	18-7123	1	CCH
65 ①	1972-73,85-95	18-7128	1	U C
65/70 ①	1989-90	18-7158	1	L C
70	1974-90	18-7123	1	CCH
70	1974-90	18-7128	1	U C
75	1975-88	18-7128	1	U C
75	1975-88	18-7123	1	CCH
V-4	1969-71	18-7117	1	CCH O
85)	1968-80	18-7133	4	CCH
88/90/100 ①	1964,81-95	18-7133	4	CCH
100	1966	18-7120	4	CCHS
110/115	1969-95	18-7133	4	CCH
125/135/140	1971-84	18-7133	4	CCH
150/155/175 ①	1977-90	18-7133	4	CCH
200/235/185	1976-85	18-7133	4	CCH

CCH S Tornillo cigüeñal L C Parte inferior cigüeñal LL C Parte larga cigüeñal ① Sólo modelos comerciales	CCH O Cabeza externa cigüeñal U C Parte superior cigüeñal CCH Cabeza cigüeñal ⑥ 89 Modelos DR, DE, DT
---	--

POWERHEAD

HP	AÑOS	AROS	CANT	DESC
4	1969-90	18-7111	1	FC
5 hasta 300 ①	1957-90	18-7111	2	FC
20/25/30	1984-86	18-7101	1	EPMV
35/40	1984-86	18-7101	1	EPMV
45 ①	1986-87	18-7101	1	EPMV
50	1985-86	18-7101	1	EPMV
55 ①	1986-88	18-7101	1	EPMV
60/65/70 ①	1985-86	18-7101	1	EPMV
75	1983-86	18-7101	1	EPMV
V-4/6 ①	1980-86	18-7101	1	EPMV
200/225	1986-88	18-7115	1	EPP
V-8	1985-86	18-7115	1	EPP

① También modelos comerciales EPMV Válvula manual	FC Conector combustible EPP Bomba eléctrica
--	--

POWER TILT Y TRIM

HP	AÑOS	AROS	CANT	DESC
35/40/45 ①	1986-89	18-7168	1	LA
45SS	1988-90	18-7134	1	TEC
45SS	1988	18-7141	4	OL
50/55/60 ①	1981-89	18-7168	1	LA
60/70/75	1981-90	18-7174	2	MVS,L
60/70/75	1981-90	18-7141	4	OL
60/70/75	1981-90	18-7165	2	MVS,S
60/70/75	1981-90	18-7102	1	FP
70/75	1981	18-7174	1	TR
V-4/6 ①	1977-79	18-7168	3	RV
V-4/6 ①	1977-90	18-7174	1	TR
V-4/6/8	1977-90	18-7174	2	MVS,L
V-4/6/8 ①	1977-90	18-7102	1	FP
V-4/6/8 ①	1977-90	18-7165	2	MVS,S
V-4/6/8 ①	1977-90	18-7141	4	OL
85	1976-79	18-7168	1	LA
115/135	1974-77	18-7168	1	LA
200	1976	18-7168	3	RV
200/300	1990	18-7168	3	RV

① También modelos comerciales TEC Tapa final trim a barra LA Línea montaje RV Válvula alivio	MVS,L Asiento válvula colector largo MVS,S Asiento válvula colector pequeño TR Barra trim OL Línea aceite
---	--

DIRECCIÓN

HP	AÑOS	Aros	Cant	DESC
60/70/75	1981-90	18-7168	4	CP
V-4/6/8	1980-90	18-7168	4	CP
V-6/8	1986-90	18-7129	2	SC
V-6/8	1986	18-7135	3	PVHT

CP Pistón control bomba RV Válvula alojamiento bomba SV Válvula	SC Cilindro PVHT Retén pistón a válvula
---	--

ALOJAMIENTO EJE TRANSMISIÓN

HP	AÑOS	AROS	CANT	DESC
2.5	1987-88	18-7101	1	SS
4 ③	1981-90	18-7101	1	SS
4 ②	1984,86-90	18-7168	1	K&S
4 ④	1984,86-90	18-7146	2	SB
4.5	1980-84,86-87	18-7168	1	K&S
4.5	1980-87	18-7146	2	SB
4.5	1980	18-7146	1	EHC
5	1984-90	18-7168	1	K&S
5	1984-90	18-7146	2	SB
6	1984-90	18-7168	1	K&S
6	1984-90	18-7146	2	SB
6.5 ①	1989-90	18-7168	1	K&S
6.5 ①	1989-90	18-7146	2	SB
7.5	1980-83	18-7146	2	SB
7.5	1980-83	18-7168	1	K&S
7.5	1980	18-7146	1	EHC
8	1984-90	18-7146	2	SB
8	1984-90	18-7168	1	K&S
28	1962-64	18-7115	1	SB
33	1965-70	18-7115	1	SB
35	1959	18-7114	1	PS
40	1960-70	18-7102	1	SS
40	1961-70	18-7114	1	PS
40 ⑤	1971-76,81-90	18-7115	1	SB
45SS	1987,88	18-7115	1	SB
60	1964-67	18-7180	4	SA
65	1968	18-7180	4	SA
75	1960-61,64-65	18-7180	4	SA
80	1966-67	18-7180	4	SA

ALOJAMIENTO EJE DE TRANSMISIÓN (Cont.)					CAJA DE ENGRANAJES (Cont.)				
HP	AÑOS	AROS	CANT	DESC	HP	AÑOS	AROS	CANT	DESC
85	1968	18-7180	4	SA	25	⑥ 1989-90	18-7137	1	SR
90	1964-65	18-7180	4	SA	28/33	1962-63,65-67	18-7165	1	WT E
100	1966-68	18-7180	4	SA	28/33	1962-70	18-7134	1	DS CC
① Comercial ② Sólo modelos "RD" ③ Sólo modelos "BR" "RL" "RC" "RE" ④ Sólo modelos "R" "RD" ⑤ '82-'90 Comercial EHC tapa alojamiento escape					K&S Soporte PS Pivote SS Pasador SA Amortiguador SB Soporte				
CAJA DE ENGRANAJES									
HP	AÑOS	AROS	CANT	DESC	HP	AÑOS	AROS	CANT	DESC
1.5/2	1968-90	18-7173	1	PBH	25	⑥ 1989-90	18-7137	1	SR
2/2.5/4	1988-90	18-7145	1	D&F S	28/33	1962-70	18-7134	1	DS CC
3/4	1957-79	18-7168	1	DS CC	28/33/35	1962-70	18-7115	1	PBH
3/4 caja engr. estánd.	1964-80	18-7173	1	PBH	28	1963-64	18-7100	1	SR
4	☆ 1981-95	18-7162	1	PBH	28	1987-95	18-7475	1	SR PP
4 RD Modelos	1984,86-95	18-7118	1	SR	30/35/33	1965-70,84-85	18-7120	1	SR PP
4.5	1980-87	18-7118	1	SR	30/33	1965-95	18-7100	1	SR
5/5.5	1957-68	18-7180	1	DS BH	30/35	1976-86	18-7109	2	PBH S
5	1965-68	18-7173	1	PBH	30/35	① 1976-95	18-7108	1	PBH
5/6/108	1984-95	18-7118	1	SR	30/35	1976-95	18-7105	2	IH S
5/6/6.5/8 6.5 HP Comm	1988-95	18-7145	2	D&F S	30/35	① 1983-95	18-7180	1	SR S
5/6/108	1989-95	18-7168	1	WT E	30	1984-90	18-7146	1	IH
5.5/6	1957-79	18-7100	1	SR	30/35	1986-95	18-7475	1	SR PP
5.5/6/7.5	1957-79	18-7117	1	PBH	30/35	① 1986-95	18-7100	1	IH
5.5	1964	18-7120	1	SR PP	30/35	① 1987-95	18-7145	2	D&F S
6/7.5	1957-79	18-7180	1	DS BH	35	1957-58	18-7165	1	WT E
6	1965-79	18-7120	1	SR PP	35	④ 1957-59,87	18-7134	1	DS CC
6.5/7.5 7.5 HP Comm	1980-90	18-7118	1	SR	35/40	⑩ 1957-90	18-7100	1	SR
6.5 Comm	1989-90	18-7168	1	WT E	35	1976-77	18-7174	1	DS CC
7.5/9.5	1957-73	18-7100	1	SR	35	⑤ 1983-84,86-90	18-7146	1	IH
9.5/10	1958-73	18-7117	1	PBH	35	⑩ 1987	18-7140	1	PBH
9.5	1964-73	18-7120	1	SR PP	35	⑩ 1987	18-7137	1	SR
9.5	1965-66,68,70-73	18-7168	1	WT E	35	⑩ 1987	18-7115	1	DS BH
9.5/9.9/15	1974-84	18-7116	1	DS CC	35	④ 1987,90	18-7475	1	BS
9.9/15	1974-95	18-7100	1	SR	35	④ 1987-90	18-7475	2	PBH S
9.9/15	1974-95	18-7168	1	WT E	40	② 1960-85,89-90	18-7115	1	PBH
9.9/15	1974-90	18-7104	1	PBH	40/48	1960-88	18-7134	1	DS CC
9.9/15	1974-90	18-7139	1	IH	40	* 1962-70	18-7152	1	PBH
9.9/15	1984-85	18-7120	1	SR PP	40	⊕ 1965-66,71,73-85	18-7120	1	SR PP
9.9/15	1986-95	18-7475	1	SR PP	40	☆ 1966,70	18-7120	4	PBH S
9.9/15	1988-92	18-7145	2	D&F S	40	1971,73-76,81-85	18-7165	1	WT E
9.9/15	1993-96	18-4248	2	D&F S	40	1984	18-7109	4	PBH S
10	1957	18-7112	1	PBH	40/45	⊕ 1984-86	18-7120	1	BS
10/14	⊕ 1957-63,88-90	18-7100	1	SR	40/48	1984-88	18-7140	1	PBH
10/18/25	1957-77	18-7116	1	DS CC	40/48	1984-88	18-7115	1	DS BH
10/14 Comm	1988-90	18-7145	2	D&F S	40/45 45 HP Comm	1984-95	18-7137	1	SR
14 Comm	1988-89	18-7475	1	SR PP	40/45 45 HP Comm	1987-95	18-7475	1	BSS
15A	1987-90	18-7174	1	WT	40/50	⊕ 1988-95	18-7145	2	D&F S
18/25	1957-76	18-7112	1	PBH	40/48/50	1989-90	18-7109	1	SR PP
18/20/25	⊕ 1957-95	18-7100	1	SR	40 Comm	1989-90	18-7165	1	WT E
18/20/28	1964-85	18-7120	1	SR PP	40 Comm	1989-90	18-7475	1	SR PP
20/25	1977,85-95	18-7105	2	IH S	40/48/50	1989-95	18-7172	1	PBH
20/25	1985-90	18-7146	1	IH	40/48/50	1989-95	18-7173	1	DS BH
20/25	1985-95	18-7180	1	SR S	45 Comm	1985-88	18-7134	1	IH
20/25	1985-95	18-7108	1	PBH	45 Comm	1985-95	18-7128	1	DS BH
20/25	⊕ 1986-95	18-7475	1	SR PP	45 Comm	1985-95	18-7127	1	PBH
20/25/30	1987-95	18-7475	2	PBH S	45/48 45 HP Comm	1987-95	18-7145	2	D&F S
20/25/28	⊕ 1988-95	18-7145	2	D&F S	45SS	1987-90	18-7134	2	DS CC
20/25	1988-95	18-7100	1	IH	45 Comm	1995	18-7475	4	PBH S
20/30	1990	18-7475	1	BS	48	1987-88	18-7475	3	PBH S
25	⊕ 1969-86	18-7120	1	SR PP	48/50	1987-95	18-7475	1	BS
25	1977	18-7109	2	PBH S	48	1987-95	18-7137	1	SR
25	1978	18-7134	1	DS CC	50/60	1958-67	18-7118	1	SR
25	1989-95	18-7475	1	BS	50/60/65	1958-68	18-7174	1	WT E
25	⑥ 1989-90	18-7172	1	PBH	50/55	1958-69	18-7174	1	DS CC
25	⑥ 1989-90	18-7109	1	SR PP	50/55/60	1968-71	18-7126	1	DS BH
25	⑥ 1989-90	18-7173	1	DS BH	50/55	1968-72	18-7129	1	PS OP
					50	1971	18-7100	1	SR
					50	⑧ 1971-74,79,81	18-7127	1	PBH
					50	⑨ 1971-81	18-7128	1	DS BH
					50/55/60	1971-84	18-7109	4	PBH S
					50/55	⊕ 1971-88	18-7134	1	DS CC
					50	☆ 1973-74	18-7156	2	SA,L
					50	☆ 1973-74	18-7146	1	SA,S
					50/55	⊕ 1973-95	18-7137	1	SR
					50	⑧ 1975,79,81,			

CAJA ENGRANAJES (Cont.)					CAJA ENGRANAJES (Cont.)				
HP	AÑOS	AROS	CANT	DESC	HP	AÑOS	AROS	CANT	DESC
	82-88	18-7115	1	DS BH	V-4	1966-68	18-7118	1	SR
50	⑧ 1975,79,81-88	18-7140	1	PBH	V-4	1966-68	18-7120	1	SR PP
50/60	1981-86	18-7120	1	BSS	80	1967	18-7120	4	PBH S
55	① 1968-69,79-81, 83-95	18-7127	1	PBH	V-4	1968-95	18-7127	1	PBH
55	⑩ 1976-82	18-7140	1	PBH	V-4/6/8	1969-95	18-7130	1	DS BH
55	⑩ 1976-82	18-7115	1	DS BH	V-4	1971-86	18-7109	4	PBH S
55	⑨ 1979-81,83-95	18-7128	1	DS BH	V-4	1973-74	18-7146	1	SA,S
55	⊕ 1981-88	18-7120	1	BS	V-4	1973-77	18-7156	2	SA,L
55 Comm	1988,90-95	18-7475	4	PBH S	V-4/6/8	1973-95	18-7137	1	SR
55 Comm	1989-95	18-7475	1	BS	V-4,6,8	1973-90	18-7158	1	DS CC
55 Comm	1989-95	18-7145	2	D&F S	V-4	1975-77	18-7178	1	SA,S
60 71 "E" Modelos	1964,66-67, 70-71	18-7120	4	PBH S	V-4	1981-86	18-7120	1	BS
60	⑦ 1964-67,80-87	18-7115	1	DS BH	V-4/6/8	1987-95	18-7475	1	BS
60/65/75 Caja engr. estándar.	1964-68	18-7152	1	PBH	V-4/6/8	1987-95	18-7145	2	D&F S
60	1964-71,86-88	18-7174	1	DS CC	85/90	1964-68	18-7152	1	PBH
60 67 Caja engr. estándar	1966-67	18-7120	1	SR PP	100	1966-68	18-7167	1	PBH
60/65	1968-71	18-7129	1	PS OP	100	⑦ 1984-90	18-7142	1	PBH
60	③ 1970-81,86-95	18-7127	1	PBH	100 Comm	1986-90	18-7475	1	BS
60	③ 1980-81,86-95	18-7128	1	DS BH	100 Comm	1987	18-7109	4	PBH S
60	1980-85	18-7134	1	DS CC	120	1985	18-7142	1	PBH
60	② 1980-87	18-7140	1	PBH	125	1971	18-7173	1	PBH
60/SST60	1980-95	18-7137	1	SR	125 Comm	1989-90	18-7142	1	PBH
60/SST60/					125 Comm	1990	18-7174	1	WT
65 65 HP Comm	1987-95	18-7475	1	BS	140	1985,88-90	18-7142	1	PBH
60/SST60/					V-6	1976-78	18-7178	1	SA,S
65 65 HP Comm	1987-95	18-7145	2	D&F S	V-6	1976-78	18-7156	2	SA,L
SST60	1989-90	18-7140	1	PBH	V-6	1976-85	18-7109	4	PBH S
SST60	1989-90	18-7174	1	DS CC	V-6	1976-90	18-7142	1	PBH
60/65/70 65 HP Comm	1989-90	18-7158	1	DS CC	V-6	1986	18-7120	1	BS
SST60	1989-90	18-7115	1	DS BH	155	⑨ 1984,89-90	18-7142	1	PBH
65/75	1960-68	18-7118	1	SR	155	③ 1984-90	18-7144	3	PBH
65 Caja engr. estándar.	1968	18-7120	1	SR PP	200/225	1987	18-7120	1	BS
65 Caja engr. estándar.	1968	18-7115	1	DS BH	V-8	1985-86	18-7120	1	BS
65	⊕ 1968-73, 85-88,90	18-7174	1	DS CC	V-8	1985-90	18-7144	3	PBH
65	⊕ 1971,73,85-86	18-7109	4	PBH S	V-8	1985-90	18-7174	1	WT
65	⊕ 1972-73,85-95	18-7127	1	PBH					
65	⊕ 1973,85-95	18-7137	1	SR					
65	⊕ 1973,85-95	18-7128	1	DS BH					
65/70 75 "B" Modelos	1973-75	18-7156	2	SA,L					
65/70 75 "B" Modelos	1973-75	18-7146	1	SA,S					
65 Comm	1985-86	18-7120	1	BS					
65/70 65 HP Comm	1988-95	18-7475	4	PBH S					
70/75	1960-65,74-88	18-7174	1	DS CC					
70/75	1974-85	18-7109	4	PBH S					
70/75	1974-95	18-7137	1	SR					
70	⑦ 1974-95	18-7128	1	DS BH					
70	⑦ 1974-95	18-7127	1	PBH					
70 15" Transom	1977-85	18-7115	1	DS BH					
70 15" Transom	1977-85	18-7140	1	PBH					
70	1981-87	18-7120	1	BS					
70	1988-95	18-7475	1	BS					
70	1988-95	18-7145	2	D&F S					
75	1960,63-65	18-7120	4	PBH S					
75	1961-65	18-7174	1	WT E					
75	⑤ 1964-65,75-88	18-7115	1	DS BH					
75	1965	18-7120	1	SR PP					
75	⑥ 1975-87	18-7127	1	PBH					
75 20" Transom	1975-87	18-7128	1	DS BH					
75 15" Transom	1975-88	18-7140	1	PBH					
75	1981-86	18-7120	1	BS					
75	1987-88	18-7475	1	BS					
75	1987-88	18-7145	2	D&F S					
V-4	1964-66,68-70	18-7120	4	PBH S					
V-4	1964-67	18-7174	1	WT E					
V-4	1964-68	18-7115	1	DS BH					
V-4	1964-72	18-7174	1	DS CC					

- ① 35 hp '87 Modelos RC, RL
 ② '62-'70 Sin cambio eléctrico/'89-'90 Comm.
 ③ '65 Caja engr. estándar/'75-'87 15" Transom
 ④ '76-'87 20" Transom
 ⑤ '77-'85 20" Transom
 ⑥ '79-'81 Arranque eléctrico
 ⑦ '79-'81 Arranque manual
 ⑧ '79-'81 Arranque manual/'82 Comm.
 ⑨ '79-'81 Arranque manual/'83-'90 Comm.
 ⑩ '80-'81 Arranque eléctrico/'86-'87 — 15" Transom
 ⑪ '80-'81 Arranque eléctrico/'86,'87 — 20" Transom
 ⑫ '87 Modelos AR, AE
 ⑬ '87 Modelos RC, RL
 ⑭ '89 Modelos DR, DE, DT
 ⑮ '89 WTLZ, WTXZ Models '90 WTESM, WTXESM Comm.
 ⑯ '89 WTLZ, WTXZ / '90 WTLES, WTESM Comm.
 ⑰ '89 WTPLY, WTALY, WTPXY, WTAXY, '90 WTPLA, WTALA, WTPXA/Comm.
 ⑱ AR, AE Modelos
 ☆ B, BR Modelos
 ⊕ también modelos comerciales
 ☆ Arranque eléctrico
 * Cambio eléctrico

- BS Juego de tornillos cojinete
 DS BH Eje transmisión a alojamiento cojinete
 DS CC Eje transmisión a alojamiento cigüeñal
 D & F S Tornillo llenado/vaciado
 WT E 5" Caja de engranajes extensión, Tubo de agua
 GC 1 Caja engranajes (11 7/16")
 GC 2 Caja engranajes (12 7/8")
 GC 3 Caja engranajes (19 1/2")
 IH Alojamiento impulsor.
 IHS Espaciador alojamiento impulsor.
 PBH Alojamiento cojinete.
 PBH S tornillo alojamiento cojinete
 PS OP Eje hélice bomba aceite
 SA,L Pasador largo
 SA,S Pasador pequeño
 SR Varilla
 SR PP Pasador
 SR S Varilla
 WT Tubo agua



JOHNSON



POTENCIA HP	AÑO	NGK	Ref. PRONAUTIC	CHAMPION	Ref. PRONAUTIC
2.0 Excel 4, Ultra	1988-1987	B7HS	050806	UL81C	050988
2.0 Colt, Jr	1990-1971	BR6S	050734	RJ8C/J8C	050945/050903
2.0, 2R	1984-1971	BR6S	050734	RJ8C/J8C	050945/050903
2.0 1 CiL.	2001-1991	BPR6HS	050827	QL87YC/L87YC	050920/050920
2.3 1 CiL.	1998-1991	BPR6HS	050827	QL87YC/L87YC	050920/050920
2.5	1988-1987	BR6HS	050714	QL82C/L82C	050966/050937
3.0 2CiL.	1997-1989	BR6HS	050714	QL82C/L82C	050966/050937
3.3 1 CiL.	2003-1991	BPR6HS	050827	QL87YC/L87YC	050920/050920
4.0 Excel, Ultra	1988-1987	BZ7HS-10	050885	QL77JC4/L77JC4	050914/050906
4.0 2 CiL.	2003-1989	BR6HS	050714	QL82C/L82C	050966/050937
4.0	1988	BZ7HS-10	050885	QL77JC4/L77JC4	050914/050906
4.0	1987-1977	BR6HS	050714	QL82C/L82C	050966/050937
4.0	1984-1981	BZ7HS-10	050885	QL77JC4/L77JC4	050914/050906
4.0	1976-1969	BR6S	050734	RJ8C/J8C	050945/050903
4.5	1985-1980	BR6HS	050714	QL82C/L82C	050966/050937
5.0 Angler	1968-1965	BR6S	050734	RJ8C/J8C	050945/050903
4.0 4 Tiempos	2003-1997	D6HA	050603		
5.0 1 CiL.	2001-1998	BZ7HS-10	050885	QL77JC4/L77JC4	050914/050906
5.0	1997-1990	BR6HS	050714	QL82C/L82C	050966/050937
5.0 4T. OHC 128cc.	1997-2003	D6HA	050603		
6.0, 6R, 6RL	1976-1971	BR6S	050734	RJ8C/J8C	050945/050903
6.0 4T OHC 128cc.	2003-1997	D6HA	050603		
6.0, 2 Tiempos	2001-1977	BR6HS	050714	QL82C/L82C	050966/050937
6.0	1976-1965	BR6S	050734	RJ8C/J8C	050945/050903
6.5 COM	1993-1981	BR6HS	050714	QL82C/L82C	050966/050937
7.5	1997-1977	BR6HS	050714	QL82C/L82C	050966/050937
8.0 COM	2001-1977	BR6HS	050714	QL82C/L82C	050966/050937
8.0 4 T. 211 cc	2003-1996	D6HA	050603		
8.0 4T OHC 211cc.	2003-1996	D6HA	050603		
8.0, 2 Tiempos	2001-1977	BR6HS	050714	QL82C/L82C	050966/050937
9.9 4 T, OHC	2003-1995	DCPR7E	050894	RA8HC	050957
9.9, 2 T SOHC	2003-2002	DCPR7E	050894	RA8HC	050957
9.9, 2 T, OHC	2001-1977	BR7HS	050853	QL82C/L82C	050966/050937
9.9 4T OHC 211cc.	1998-1996	D6HA	050603		
10 COM	2003-1994	BR7HS	050853	QL82C/L82C	050966/050937
10 COM	1993-1992	BZ7HS-10	050885	QL77JC4/L77JC4	050914/050906
10 COM	1982-1981	BUHW-2	050840		
14 COM	1991-1981	BZ7HS-10	050885	QL77JC4/L77JC4	050914/050906
14	1989-1988	BZ7HS-10	050885	QL77JC4/L77JC4	050914/050906
15 Kero	1998-1995	BUHXW-1	050604	UL77V	050932
15 COM	2001-1994	BR7HS	050853	QL82C/L82C	050966/050937
15 COM	1993-1992	BZ7HS-10	050885	QL77JC4/L77JC4	050914/050906
15, 4 T, OHC	2003-1995	DCPR7E	050894	RA8HC	050957
15, 2 T	2001-1994	BR7HS	050853	QL82C/L82C	050966/050937
15	1992-1977	BZ7HS-10	050885	QL77JC4/L77JC4	050914/050906
15	1980-1978	BUHW-2	050840		
15	1976-1974	B7HS	050806	UL81C	050988



JOHNSON



POTENCIA HP	AÑO	NGK	Ref. PRONAUTIC	CHAMPION	Ref. PRONAUTIC
15	1971-1956	BR6S	050734	RJ8C/J8C	050945/050903
18 Jet 2 CiL.	1998-1995	BR7HS	050853	QL82C/L82C	050966/050937
20 Jet 2 CiL.	2001-1999	BR7HS	050853	QL82C/L82C	050966/050937
20, 2 CiL.	1998-1978	BR7HS	050853	QL82C/L82C	050966/050937
20	1993-1978	BR7HS	050853	QL82C/L82C	050966/050937
25 COM	2002-1981	BUHXW-1	050604	UL77V	050932
25, 3 CiL.	2001-1995	BR6HS	050714	QL82C/L82C	050966/050937
25, E,EL,R,RL	1976-1973	BR6S	050734	RJ8C/J8C	050945/050903
25, 2 CiL.	2002-1977	BR7HS	050853	QL82C/L82C	050966/050937
25	1976-1969	BR6S	050734	RJ8C/J8C	050945/050903
28, SPL, 2 CiL.	1997-1978	BR7HS	050853	QL82C/L82C	050966/050937
28 Jet	2003-1992	BPZ8HS-10	050842	QL78YC/L78YC	050917/050933
30 Jet 2 CiL.	2001-1999	BPR7HS	050829	QL78YC/L78YC	050917/050933
30, 4 T, OHC	2003-1995	DCPR7E	050894	RA8HC	050957
30, 2 CiL.	2002-1978	BR7HS	050853	QL82C/L82C	050966/050937
35 Jet 2 CiL.	2003-1993	BPZ8HS-10	050842	QL78YC/L78YC	050917/050933
35, 3 CiL.	2001-1995	BR7HS	050853		
35, 2 CiL.	1997-1977	BZ7HS-10	050885	QL77JC4/L77JC4	050914/050906
40 Jet 3 CiL.	2001-1999	BR7HS	050853	QL82C/L82C	050966/050937
40 COM 45 cid	2003-1984	BUHXW-1	050604	UL77V	050932
40 COM 43 cid	1990-1981	BR7HS	050853	QL82C/L82C	050966/050937
40, E,EL,R,RL	1976-1975	BZ7HS-10	050885	QL77JC4/L77JC4	050914/050906
40, 4 T, DOHC	2003-2002	DCPR7E	050894	RA8HC	050957
40, 2 CiL.	2002-1989	BPZ8HS-10	050842	QL78YC/L78YC	050917/050933
40, 2 CiL.	1988-1980	BZ7HS-10	050885	QL77JC4/L77JC4	050914/050906
45 COM	2002-1984	BUHXW-1	050604	UL77V	050932
48, SPL 2 CiL.	1997-1994	BPZ8HS-10	050842	QL78YC/L78YC	050917/050933
48, 2 CiL.	1997-1989	BPZ8HS-10	050842	QL78YC/L78YC	050917/050933
48,2 CiL.	1988-1980	BZ7HS-10	050885	QL77JC4/L77JC4	050914/050906
50,3 CiL.	1998-1995	BPZ8HS-10	050842	QL78YC/L78YC	050917/050933
50,2 CiL.	2002-1989	BPZ8HS-10	050842	QL78YC/L78YC	050917/050933
50,2 CiL.	1988-1980	BZ7HS-10	050885	QL77JC4/L77JC4	050914/050906
55 COM,2 CiL.	1995-1994	BPZ8HS-10	050842	QL78YC/L78YC	050917/050933
55 COM	2003-1986	BUHXW-1	050604	UL77V	050932
55,2 CiL.	1989-1976	B7HS	050806	UL81C	050988
60,4 T,OHC	2005-2002	BPR6ES	050826		
60,3 CiL.,56 cid	1998-1994	BPZ8HS-10	050842	QL78YC/L78YC	050917/050933
60,3 CiL.,56 cid	1993-1989	BZ7HS-10	050885	QL77JC4/L77JC4	050914/050906
60,3 CiL.,49 cid	1989-1975	BZ7HS-10	050885	QL77JC4/L77JC4	050914/050906
60,2 CiL.	1985-1980	BZ7HS-10	050885	QL77JC4/L77JC4	050914/050906
65 COM,3 CiL.	1995-1994	BPZ8HS-10	050842	QL78YC/L78YC	050917/050933
65 COM HC LC	2003-1988	BUHXW-1	050604	UL77V	050932
65 COM HC LC	1987-1984	BZ7HS-10	050885	QL77JC4/L77JC4	050914/050906
65 Jet CV4	1997-1992	BR7HS	050853	QL82C/L82C	050966/050937
65,3 CiL.	1973-1972	BZ7HS-10	050885	QL77JC4/L77JC4	050914/050906
70,3 CiL.,56 cid	2001-1997	BPZ8HS-10	050842	QL78YC/L78YC	050917/050933
70,3 CiL.,56 cid	1993-1989	BZ7HS-10	050885	QL77JC4/L77JC4	050914/050906



JOHNSON



POTENCIA HP	AÑO	NGK	Ref. PRONAUTIC	CHAMPION	Ref. PRONAUTIC
70,3 CiL.,49 cid	1989-1975	BZ7HS-10	O50885	QL77JC4/L77JC4	O50914/O50906
75,3 CiL.,49 cid	1989-1975	BZ7HS-10	O50885	QL77JC4/L77JC4	O50914/O50906
80 Jet CV4	2001-1979	BR7HS	O50853	QL82C/L82C	O50966/O50937
85,V4 Backtroller	1995-1994	BR7HS	O50853	QL82C/L82C	O50966/O50937
85	1993-1986	BZ7HS-10	O50885	QL77JC4/L77JC4	O50914/O50906
85	1980-1968	B7HS	O50806	UL81C	O50988
88 CV4 SPL	1997-1979	BR7HS	O50853	QL82C/L82C	O50966/O50937
90 Turbojet CV4	1998-1994	BR7HS	O50853	QL82C/L82C	O50966/O50937
90 LV4 FFI	1998	PZFR6H	O50886	XC12PEPB	
90 LV4	2000-1995	BPZ8HS-10	O50842	QL78YC/L78YC	O50917/O50933
90 CV4	1998-1979	BR7HS	O50853	QL82C/L82C	O50966/O50937
100 V4	1980-1979	B7HS	O50806	UL81C	O50988
100 COM	2001-1984	BUHXW-1	O50604	UL77V	O50932
105 COM LV4	2003-1997	BPZ8HS-10	O50842	QL78YC/L78YC	O50917/O50933
105 LV6 105 Jet	2003-1993	BPZ8HS-10	O50842	QL78YC/L78YC	O50917/O50933
110 CV4	1997-1979	BR7HS	O50853	QL82C/L82C	O50966/O50937
112 CV4	1997-1979	BR7HS	O50853	QL82C/L82C	O50966/O50937
115 Turbojet CV4	1998-1994	B7HS	O50806	UL81C	O50988
115 LV4 FFI	1998	PZFR6H	O50886	XC12PEPB	
115 Fast Strike LV4	2002-1995	BPZ8HS-10	O50842	QL78YC/L78YC	O50917/O50933
115 CV4	1998-1979	BR7HS	O50853	QL82C/L82C	O50966/O50937
115 COM	1984-1975	B7HS	O50806	UL81C	O50988
115	1993-1986	BZ7HS-10	O50885	QL77JC4/L77JC4	O50914/O50906
115	1979-1973	BZ7HS-10	O50885	QL77JC4/L77JC4	O50914/O50906
115	1985	BUHXW-1	O50604	UL77V	O50932
120 LV4	2003-1985	BPZ8HS-10	O50842	QL78YC/L78YC	O50917/O50933
125 COM	1972-1971	B7HS	O50806	UL81C	O50988
130 LV4	2003-1985	BPZ8HS-10	O50842	QL78YC/L78YC	O50917/O50933
135 Starflite	1984-1973	BUHXW-1	O50604	UL77V	O50932
140 LV4	2003-1985	BPZ8HS-10	O50842	QL78YC/L78YC	O50917/O50933
140	1984-1973	BUHXW-1	O50604	UL77V	O50932
150 LV6 FFI	1998-1997	PZFR6H	O50886	XC12PEPB	
150 Fast Strike LV6	2002-1991	BPZ8HS-10	O50842	QL78YC/L78YC	O50917/O50933
150 CV6	1991-1988	BZ7HS-10	O50885	QL77JC4/L77JC4	O50914/O50906
150 CV6	1987-1978	BUHXW-1	O50604	UL77V	O50932
150 COM LV6	1998-1993	BPZ8HS-10	O50842	QL78YC/L78YC	O50917/O50933
155 CV6	1987-1978	BUZ8H	O50735	QL16V	O50911
155 COM CV6	1992-1989	BUZ8H	O50735	QL16V	O50911
175 LV6 FFI	1998	PZFR6H	O50886	XC12PEPB	
175 Fast Strike LV6	2002-1991	BPZ8HS-10	O50842	QL78YC/L78YC	O50917/O50933
175 CV6	1991-1988	BZ7HS-10	O50885	QL77JC4/L77JC4	O50914/O50906
175	1987-1977	BUHXW-1	O50604	UL77V	O50932
185	1987-1977	BUZ8H	O50735	QL16V	O50911
185	1993-1990	BZ7HS-10	O50885	QL77JC4/L77JC4	O50914/O50906
200	1983-1976	BUZ8H	O50735	QL16V	O50911
200 COM	1992	BUZ8H	O50735	QL16V	O50911
200 COM	1998-1993	BPZ8HS-10	O50842	QL78YC/L78YC	O50917/O50933



JOHNSON



POTENCIA HP	AÑO	NGK	Ref. PRONAUTIC	CHAMPION	Ref. PRONAUTIC
200 V6	1993-1986	BZ7HS-10	O50842	QL77JC4/L77JC4	O50914/O50906
200 Venom LV6	2003-1994	BPZ8HS-10	O50842	QL78YC/L78YC	O50917/O50933
225 V6	1993-1986	BZ7HS-10	O50885	QL77JC4/L77JC4	O50914/O50906
225 Venom LV6	2003-1994	BPZ8HS-10	O50842	QL78YC/L78YC	O50917/O50933
235	1985-1978	BUHXW-1	O50604	QL16V	O50911
250 LV6	2001-1999	BUHXW-1	O50604	QL16V	O50911
250 V8	1997-1985	BPZ8HS-10	O50842	QL78YC/L78YC	O50917/O50933
275	1988-1985	BPR7HS	O50829	QL78YC/L78YC	O50917/O50933
300 V8	1997-1985	BPZ8HS-10	O50842	QL78YC/L78YC	O50917/O50933



EVINRUDE



POTENCIA HP	AÑO	NGK	Ref. PRONAUTIC	CHAMPION	Ref. PRONAUTIC
1.2 Magneto	1990-1986	BR6S	O50734	RJ8C/J8C	O50945/O50903
2.0 Jr. Colt	1990-1971	BR6S	O50734	RJ8C/J8C	O50945/O50903
2.0, 2R	1984-1971	BR6S	O50734	RJ8C/J8C	O50945/O50903
2.0, 1 Cil.	1998-1991	BPR6HS	O50827	QL87YC/L87YC	O50920/O50938
2.3	1997-1991	BPR6HS	O50827	QL87YC/L87YC	O50920/O50938
2.5	1988-1987	BZ7HS-10	O50842	QL77JC4/L77JC4	O50914/O50906
3.0, 2 Cil.	1997-1989	BR6HS	O50714	QL82C/L82C	O50966/O50937
3.3, 1 Cil.	2003-1991	BPR6HS	O50827	QL87YC/L87YC	O50920/O50938
3.4-4.0 Yachtwin	1974-1964	BR6S	O50734	RJ8C/J8C	O50945/O50903
4.0,Ultra,Excel	1988-1987	BZ7HS-10	O50885	QL77JC4/L77JC4	O50914/O50906
4.0,4R,4W	1976-1969	BR6S	O50734	RJ8C/J8C	O50945/O50903
4.0,2 Cil.	1998-1989	BR6HS	O50714	QL82C/L82C	O50966/O50937
4.0	1987-1977	BR6HS	O50714	QL82C/L82C	O50966/O50937
4.0	1984-1981	BZ7HS-10	O50842	QL77JC4/L77JC4	O50914/O50906
4.5	1985-1980	BR6HS	O50714	QL82C/L82C	O50966/O50937
5.0,4 T,OHC 128cc	2008-1997	DR5HS	O50852		
5.0	1998	BR6HS	O50714	QL82C/L82C	O50966/O50937
5.0	1997-1990	BR6HS	O50714	QL82C/L82C	O50966/O50937
5.0, 4 T	2008-1997	D6HA			
6.0,6R,6RL	1976-1971	BR6S	O50734	RJ8C/J8C	O50945/O50903
6.0,4T,OHC 128cc	2008-1997	DR5HS	O50852		
6.0,2T	1998-1977	BR6HS	O50714	QL82C/L82C	O50966/O50937
6.0	1976-1965	BR6S	O50734	RJ8C/J8C	O50945/O50903
6.0, 4T	2008-1997	D6HA			
6.5 COM	1993-1981	BR6HS	O50714	QL82C/L82C	O50966/O50937
7.5	1997-1977	BR6HS	O50714	QL82C/L82C	O50966/O50937
8.0 COM	1998-1977	BR6HS	O50714	QL82C/L82C	O50966/O50937
8.0 4T. OHC 211cc	2008-1996	DR5HS	O50852		
8.0,2T	1998-1977	BR6HS	O50714	QL82C/L82C	O50966/O50937
8.0, 4T	1997-1995	D6HA			
9.9, 4T,OHC 305cc	2008-1998	DCPR7E	O50894	RA8HC	O50957
9.9,4T,OHC 302cc	1997-1995	DCPR7E	O50894	RA8HC	O50957
9.9,4T,211cc	1997-1996	D6HA			



EVINRUDE



POTENCIA HP	AÑO	NGK	Ref. PRONAUTIC	CHAMPION	Ref. PRONAUTIC
9.9, 2T	2001-1977	BR7HS	O50853	QL82C/L82C	O50966/O50937
9.9	1976-1974	B7HS	O50806	UL81C	O50988
10 COM	2003-1994	BR7HS	O50853	QL82C/L82C	O50966/O50937
10 COM	1993-1992	BZ7HS-10	O50842	QL77JC4/L77JC4	O50914/O50906
10R,10RL,10E,10EL	1976-1975	BZ7HS-10	O50842	QL77JC4/L77JC4	O50914/O50906
14 COM	1991-1981	BZ7HS-10	O50842	QL77JC4/L77JC4	O50914/O50906
14	1989-1988	BZ7HS-10	O50842	QL77JC4/L77JC4	O50914/O50906
15 Kero	1998-1995	BUHXW-1	O50604	UL77V	O50932
15 COM	2001-1994	BR7HS	O50853	QL82C/L82C	O50966/O50937
15 COM	1993-1992	BZ7HS-10	O50842	QL77JC4/L77JC4	O50914/O50906
15,4 T,OHC 305cc	2003-1995	DCPR7E	O50894	RA8HC	O50957
15, 2T	1998-1994	BR7HS	O50853	QL82C/L82C	O50966/O50937
15E,15EL,15R,15RL	1976-1974	BZ7HS-10	O50842	QL77JC4/L77JC4	O50914/O50906
15	1992-1977	BZ7HS-10	O50842	QL77JC4/L77JC4	O50914/O50906
15	1976-1974	B7HS	O50806	UL81C	O50988
18 Jet 2 Cil.	1998-1995	BR7HS	O50853	QL82C/L82C	O50966/O50937
18 Fastwin	1973-1957	BR6S	O50734	RJ8C/J8C	O50945/O50903
18	1973-1957	BR6S	O50734	RJ8C/J8C	O50945/O50903
18	1972-1950	BR6S	O50734	RJ8C/J8C	O50945/O50903
20,2 Cil.	1998-1978	BR7HS	O50853	QL82C/L82C	O50966/O50937
20	1993-1978	BR7HS	O50853	QL82C/L82C	O50966/O50937
25,Evinrude 25	1993-1978	BZ7HS-10	O50842	QL77JC4/L77JC4	O50914/O50906
25 COM	1998-1981	BUHXW-1	O50604	UL77V	O50932
25,3 Cil.	1998-1995	BR6HS	O50714	QL82C/L82C	O50966/O50937
25R,25RL	1976-1973	BR6S	O50734	RJ8C/J8C	O50945/O50903
25E,25EL	1976-1973	BR6S	O50734	RJ8C/J8C	O50945/O50903
25,2 Cil	1998-1977	BR7HS	O50853	QL82C/L82C	O50966/O50937
25	1977	BR7HS	O50853	QL82C/L82C	O50966/O50937
25	1976-1969	BR6S	O50734	RJ8C/J8C	O50945/O50903
25, 4 T	2001-2000	DCPR7E	O50894		
28 Jet	2003-1992	BPZ8HS-10	O50842	QL78YC/L78YC	O50917/O50933
28,2 Cil.	1997-1978	BR7HS	O50853	QL82C/L82C	O50966/O50937
30, 4 T	2003-2000	DCPR7E	O50894	RA8HC	O50957
30,2 Cil.	1998-1978	BR7HS	O50853	QL82C/L82C	O50966/O50937
30,4 T OHC	2003-1995	DCPR7E	O50894		
35 Jet,2 Cil.	2001-1993	BPZ8HS-10	O50842	QL78YC/L78YC	O50917/O50933
35,3 Cil.	2001-1995	BR6HS	O50714	QL82C/L82C	O50966/O50937
35,2 Cil.	1997-1977	BZ7HS-10	O50885	QL77JC4/L77JC4	O50914/O50906
35	1976	BZ7HS-10	O50885	QL77JC4/L77JC4	O50914/O50906
40 COM45 cid	2003-1984	BUHXW-1	O50604	UL77V	O50932
40 COM43 cid	1990-1981	B7HS	O50806	UL81C	O50988
40,4T DOHC 815cc	2008-1999	DCPR7E	O50894	RA8HC	O50957
40,2 Cil.	1998-1989	BPZ8HS-10	O50842	QL78YC/L78YC	O50917/O50933
40,E-TEC	2005-2004	PZFR6H	O50886		
40,2 Cil.	1988-1980	BZ7HS-10	O50842	QL77JC4/L77JC4	O50914/O50906
40	1976-1974	B7HS	O50806	UL81C	O50988
40,4T DOHC	2003-2002	DCPR7E	O50894		

BUJÍAS JOHNSON / EVINRUDE



EVINRUDE



POTENCIA HP	AÑO	NGK	Ref. PRONAUTIC	CHAMPION	Ref. PRONAUTIC
45 COM	2003-1991	BUHXW-1	O50604	UL77V	O50932
45 COM	1990-1986	BUZHW-2			
48 SPL 2 Cil.	1997-1994	BPZ8HS-10	O50842	QL78YC/L78YC	O50917/O50933
48,2 Cil.	1997-1989	BPZ8HS-10	O50842	QL78YC/L78YC	O50917/O50933
48,2 Cil.	1998-1990	BZ7HS-10	O50885	QL77JC4/L77JC4	O50914/O50906
50,4T,DOHC 815cc	2008-1999	DCPR7E	O50894	RA8HC	O50957
50, 3 Cil.	1998-1995	BPZ8HS-10	O50842	QL78YC/L78YC	O50917/O50933
50, 2 Cil.	2002-1989	BPZ8HS-10	O50842	QL78YC/L78YC	O50917/O50933
50, 2 Cil.	1988-1980	BZ7HS-10	O50885	QL77JC4/L77JC4	O50914/O50906
50	1979-1978	B7HS	O50806	UL81C	O50988
50 E-TEC	2005-2004	PZFR6H	O50886		
55 COM,2 Cil.	1995-1994	BPZ8HS-10	O50842	QL78YC/L78YC	O50917/O50933
55 COM	2003-1986	BUHXW-1	O50604	UL77V	O50932
55,2 Cil.	1989-1976	B7HS	O50806	UL81C	O50988
60,4 T,OHC	2008-2002	BPR6ES	O50826		
60,3 Cil. 56 cid	1998-1994	BPZ8HS-10	O50842	QL78YC/L78YC	O50917/O50933
60,3 Cil. 56 cid	1993-1989	BZ7HS-10	O50885	QL77JC4/L77JC4	O50914/O50906
60,3 Cil. 49 cid	1989-1975	BZ7HS-10	O50885	QL77JC4/L77JC4	O50914/O50906
60,2 Cil.	1985-1980	BZ7HS-10	O50885	QL77JC4/L77JC4	O50914/O50906
60 E-TEC	2005-2004	PZFR6H	O50886		
65,CV4 65 Jet	1997-1992	BR7HS	O50853	QL82C/L82C	O50966/O50937
65 COM,3 Cil.	1995-1994	BPZ8HS-10	O50842	QL78YC/L78YC	O50917/O50933
65 COM HOLO	1997-1988	BUHXW-1	O50604	UL77V	O50932
65 COM HOLO	1987-1984	BZ7HS-10	O50885	QL77JC4/L77JC4	O50914/O50906
70,4T OHC 298cc	2003-1998	BPR6ES	O50826		
70,3 Cil. 56 cid	1998-1994	BPZ8HS-10	O50842	QL78YC/L78YC	O50917/O50933
70,3 Cil. 56 cid	1993-1989	BZ7HS-10	O50885	QL77JC4/L77JC4	O50914/O50906
70,3 Cil. 49 cid	1989-1975	BZ7HS-10	O50885	QL77JC4/L77JC4	O50914/O50906
75,3 Cil. 49 cid	1989-1975	BZ7HS-10	O50885	QL77JC4/L77JC4	O50914/O50906
75 E-TEC	2005-2004	PZFR6H	O50886		
80 Jet CV4	1998-1979	BR7HS	O50853	QL82C/L82C	O50966/O50937
85,V4 Backtroller	1995-1994	BR7HS	O50853	QL82C/L82C	O50966/O50937
85	1993-1986	BZ7HS-10	O50885	QL77JC4/L77JC4	O50914/O50906
85	1980-1968	B7HS	O50806	UL81C	O50988
88 CV4 SPL	1997-1979	BR7HS	O50853	QL82C/L82C	O50966/O50937
90 E-TEC 1.3L	2008-2007	BZFRN-E			
90 Turbojet CV4	1997-1994	BR7HS	O50853	QL82C/L82C	O50966/O50937
90 LV4 FFI	1998-2000	PZFR6H	O50886	XC12PEPB	
90 LV4	1998-1995	BPZ8HS-10	O50842	QL78YC/L78YC	O50917/O50933
90 CV4	1998-1979	BR7HS	O50853	QL82C/L82C	O50966/O50937
90 E-TEC	2005-2004	PZFR6H	O50886		
100 V4	1980-1979	B7HS	O50806	UL81C	O50988
100 COM	1998-1984	BUHXW-1	O50604	UL77V	O50932
105 COM LV4	2003-1997	BPZ8HS-10	O50842	QL78YC/L78YC	O50917/O50933
105 LV6 105 Jet	2003-1993	BPZ8HS-10	O50842	QL78YC/L78YC	O50917/O50933
110 CV4	1997-1979	BR7HS	O50853	QL82C/L82C	O50966/O50937
112 CV4	1997-1979	BR7HS	O5085	QL82C/L82C	O50966/O50937



EVINRUDE



POTENCIA HP	AÑO	NGK	Ref. PRONAUTIC	CHAMPION	Ref. PRONAUTIC
115 Turbojet CV4	1998-1994	B7HS	O50806	UL81C	O50988
115 LV4 FFI	2003-1998	PZFR6H	O50886	XC12PEPB	
115 Intruder LV4	1998-1995	BPZ8HS-10	O50842	QL78YC/L78YC	O50917/O50933
115 CV4	1998-1979	BR7HS	O50853	QL82C/L82C	O50966/O50937
115 COM	1984-1975	B7HS	O50806	UL81C	O50988
115	1993-1986	BZ7HS-10	O50885	QL77JC4/L77JC4	O50914/O50906
115	1979-1973	BZ7HS-10	O50885	QL77JC4/L77JC4	O50914/O50906
115	1985	BUHXW-1	O50604	UL77V	O50932
115 E-TEC 1.7L V4	2008-2007	BZFR6N-E			
120 LV4	2003-1985	BPZ8HS-10	O50842	QL78YC/L78YC	O50917/O50933
125 COM	1972-1971	B7HS	O50806	UL81C	O50988
130 LV4	2003-1985	BPZ8HS-10	O50842	QL78YC/L78YC	O50917/O50933
135	1984-1973	BUHXW-1	O50604	UL77V	O50932
140 LV4	2003-1985	BPZ8HS-10	O50842	QL78YC/L78YC	O50917/O50933
140	1984-1973	BUHXW-1	O50604	UL77V	O50932
150 LV6 FFI	1998-1997	PZFR6H	O50886	XC12PEPB	
150 Intruder LV6	1998-1991	BPZ8HS-10	O50842	QL78YC/L78YC	O50917/O50933
150 CV6	1991-1988	BZ7HS-10	O50885	QL77JC4/L77JC4	O50914/O50906
150 CV6	1987-1978	BUHXW-1	O50604	UL77V	O50932
150 COM LV6	1998-1993	BPZ8HS-10	O50842	QL78YC/L78YC	O50917/O50933
155 CV6	1987-1978	BUHXW-1	O50604	UL77V	O50932
155 COM CV6	1992-1989	BUHXW-1	O50604	UL77V	O50932
175 LV6 FFI	1998	PZFR6H	O50886	XC12PEPB	
175 Intruder LV6	1998-1991	BPZ8HS-10	O50842	QL78YC/L78YC	O50917/O50933
175 CV6	1991-1988	BZ7HS-10	O50885	QL77JC4/L77JC4	O50914/O50906
175	1987-1977	BUHXW-1	O50604	UL77V	O50932
185	1987-1977	BUZ8H		QL16V	O50911
185 COM	1993-1990	BZ7HS-10	O50885	QL77JC4/L77JC4	O50914/O50906
200 Vindicator L	1998-1994	BPZ8HS-10	O50842	QL78YC/L78YC	O50917/O50933
200 V6	1993-1986	BZ7HS-10	O50885	QL77JC4/L77JC4	O50914/O50906
200 LV6 FFI	2004-1999	PZFR6H	O50886	XC12PEPB	
200 COM	1998-1993	BPZ8HS-10	O50842	QL78YC/L78YC	O50917/O50933
200 COM	1992	BUHXW-1	O50604	UL77V	O50932
200	1983-1976	BUHXW-1	O50604	UL77V	O50932
225 Vindicator	1998-1994	BPZ8HS-10	O50842	QL78YC/L78YC	O50917/O50933
225 LV6 FFI	2004-1999	PZFR6H	O50886	XC12PEPB	
225	1993-1986	BZ7HS-10	O50885	QL77JC4/L77JC4	O50914/O50906
235	1985-1978	BUHXW-1	O50604	UL77V	O50932
250 V8	1997-1985	BPZ8HS-10	O50842	QL78YC/L78YC	O50917/O50933
175	1988-1985	BPZ8HS-10	O50842	QL78YC/L78YC	O50917/O50933
300 V8	1997-1985	BPZ8HS-10	O50842	QL78YC/L78YC	O50917/O50933



**18-5225
KIT CABLE DE BUJÍAS**
Kit incluye 25 pies de cable de encendido 7mm Hypalon con alma metálica y un amplio surtido de 3 tipos de terminales para fuerabordas.
Cable disponible en 100' bobina 18-5226



**18-5226
CABLE ENCENDIDO**
Alma metálica
100' Bobina
7mm Hypalon



**18-5153
JUEGO DE CONTACTOS**
Reemplaza: 75101A, 1340135, 36550135



**18-5241
CONDENSADOR**
Reemplaza: 38850115

HP	años	Juego de contactos	Condensador	HP	Años	Juego de contactos	Condensador
3.6	1953-57	18-5153	—	7.5	1961-68	18-5153 ②	—
6	1960-62	18-5153 ②	—	10	1958	—	18-5241 ②
7.5	1952-87	18-5153 ②	—	25	1959	18-5153 ② ③	—
7.5	1958	18-5153 ② ③	—	30 - 33	1955-56	18-5153 ②	—
7.5	1960	18-5153 ②	—	40	1957-59	18-5153 ② ③	—

② 2 requeridos

③ Sólo REPCO Magnético

LINEA DE COMBUSTIBLE LONG. 8'

5/16"
CONECTOR DEPÓSITO



*

18-8013EP-1 SILVERADO 4000 Premium



18-8004EP-1 BOMBA



*

COMPONENTES LINEA DE COMB

LINEA DE COMBUSTIBLE LONG. 8'

3/8"
CONECTOR DEPÓSITO



*

18-8015EP-1 SILVERADO 4000 Premium



18-8005EP-1 BOMBA



*

COMPONENTES LINEA DE COMB

LINEA DE COMBUSTIBLE LONG. 12'

5/16"
CONECTOR DEPÓSITO



*

18-8032EP-1 SILVERADO 4000 Premium



18-8004EP-1 BOMBA



*

COMPONENTES LINEA DE COMB



BOMBA COMBUSTIBLE
Completo con abrazaderas

Ref #	Descripción
18-8002EP-1	Para 1/4" mang D.I.
18-8004PE-1	Para 5/16" D.I. (bomba gran capacidad)
18-8005EP-1	Para 3/8" D.I. (Bomba gran capacidad)



18-7852-1 KIT SEPARADOR COMB/AGUA

Incluye:
18-7845 Filtro - 18-7853-1 soporte
18-4256 1/4" (2) Brass Plugs
18-9004 Sellante para las roscas de los filtros



FILTROS COMBUSTIBLE

18-7828-1 (1/4" pequeño)	18-7830 (5/16")
18-7829 (1/4" grande)	18-7831 (3/8")



18-79989 STICKS DE ARRASTRE
Para: Para mayoría de fuerabordas 150hp con tilt/trim integral.

* Depósitos y motores como imagen.

MERCURY FUERABORDA

HP	CIL	DESDE	AÑO	HP	CIL	DESDE	AÑO	HP	CIL	DESDE	AÑO
2.2	1	8075603	1984	8	2	C221500	1990	35	2	1755799	1965
2.2	1	8087123	1985	9.8	2	5206550	1979	35	2	1960827	1966
2.2	1	A800761	1986	9.8	2	5541280	1980-81	35	2	2097800	1967
2.2	1	A805221	1987	9.8	2	5965263	1982	35	2	2300972	1968
2.2	1	A817421	1988	9.8	2	6263906	1983	35	2	2487558	1969
2.2	1	A837101	1989	9.8	2	6438338	1984	35	2	6445653	1984
3	1	A855097	1990	9.8	2	6620196	1985	35	2	6626696	1985
3.4 L	6	6436883	1984	9.8 (100)	2	1397581	1961	35	2	A922171	1986
3.4 L	6	A129445	1985	9.8 (110)	2	1455240	1962	35	2	B110789	1987
3.4 L	6	A912426	1986	9.8 (110)	2	1474328	1963	35	2	B238644	1988
3.5	1	6202173	1983	9.8 (110)	2	1607083	1964	35	2	B393190	1989
3.5	1	6434771	1984	9.8 (110)	2	1742746	1965	35 (300)	4	1271885	1960
3.5	1	6594744	1985	9.8 (110)	2	1865779	1966	40	2	2874704	1970
3.6	1	5404657	1980-81	9.8 (110)	2	2098352	1967	40	2	3043031	1971
3.6	1	5910968	1982	9.8 (110)	2	2290663	1968	40	2	3219678	1972
3.9	1	1655013	1964	9.8 (110)	2	2508759	1969	40	2	3474578	1973
3.9	1	1738941	1965	9.8 (110)	2	2798057	1970	40	2	3859435	1974
3.9	1	1865633	1966	9.8 (110)	2	3002814	1971	40	2	4118385	1975
3.9	1	2098037	1967	9.8 (110)	2	3263263	1972	40	2	4362215	1976
3.9	1	2278851	1968	9.8 (110)	2	3482753	1973	40	2	4564002	1977
4	1	2498136	1969	9.8 (110)	2	3795658	1974	40	2	4860103	1978
4	1	2771662	1970	9.8 (110)	2	4079675	1975	40	2	5174089	1979
4	1	3028361	1971	9.8 (110)	2	4304785	1976	40	2	5556230	1980-81
4	1	3296137	1972	9.8 (110)	2	4605112	1977	40	2	5991215	1982
4	1	3529446	1973	9.8 (110)	2	4839254	1978	40	2	6228285	1983
4	1	3764825	1974	9.9	2	A918999	1986	40	4	C159200	1989
4	2	5589202	1980-81	9.9	2	B114231	1987	40	4	C221500	1990
4	2	9075839	1976	9.9	2	B233200	1988	40 350	2	1356948	1961
4	2	9172806	1978	9.9	2	B385500	1989	45	4	1476510	1962
4	1	A818721	1988	9.9	2	C221500	1990	45	4	A914859	1986
4	1	A837101	1989	10	2	1290910	1960	45	4	B110789	1987
4	1	A855097	1990	15	2	1288910	1960	45	4	B238644	1988
4	1	A906702	1986	15	2	1346448	1961	45	4	B393190	1989
4	1	B114109	1987	15	2	B293117	1988	45 (400)	4	1279685	1960
4.5	1	4108120	1975	15	2	B385500	1989	45 (400)	4	1384806	1961
4.5	1	4377557	1976	15	2	C221500	1990	50	4	1421113	1961
4.5	1	4597262	1977	18	2	5860332	1980-81	50	4	1477910	1962
4.5	1	4869518	1978	18	2	5954911	1982	50	4	1552535	1963
4.5	1	5270784	1979	18	2	6171607	1983	50	4	1605952	1964
4.5	1	5595532	1980-81	18	2	6443973	1984	50	4	1755549	1965
4.5	1	6025119	1982	18	2	6617631	1985	50	4	1870389	1966
4.5	1	6232381	1983	20	2	1558310	1963	50	4	2097445	1967
4.5	1	6428076	1984	20	2	1606903	1964	50	4	2305101	1968
4.5	1	6608536	1985	20	2	1755849	1965	50	4	2514919	1969
5	1	A819951	1988	20	2	1866496	1966	50	4	2736807	1970
5	1	A837101	1989	20	2	1997990	1967	50	4	3009934	1971
5	1	A855097	1990	20	2	2296267	1968	50	4	3235063	1972
6	2	1408611	1961	20	2	2550065	1969	50	4	3478003	1973
6	2	1485612	1962	20	2	2827677	1970	50	4	3816308	1974
6	2	1551443	1963	20	2	2991679	1971	50	4	4141450	1975
6	2	1607513	1964	20	2	3226958	1972	50	4	4357650	1976
6	2	1745521	1965	20	2	3537531	1973	50	4	4576237	1977
6	2	1958278	1966	20	2	3755885	1974	50	4	4962056	1978
6	2	2096171	1967	20	2	4103290	1975	50	4	5193259	1979
6	2	2284857	1968	20	2	4293920	1976	50	4	5531630	1980-81
6	2	A910596	1986	20	2	4580036	1977	50	4	5949386	1982
6	2	B114231	1987	20	2	4819249	1978	50	4	6275323	1983
6	2	B233200	1988	20	2	5183393	1979	50	4	6448808	1984
6	2	B385500	1989	20	2	5606492	1980-81	50	4	6586624	1985
7.5	2	2529895	1969	20	2	A910971	1986	50	3	A912478	1986
7.5	2	2810637	1970	20	2	B114231	1987	50	3	B110789	1987
7.5	2	3016581	1971	20	2	B238464	1988	50	3	B239242	1988
7.5	2	3274633	1972	20	2	B385500	1989	50	3	B396036	1989
7.5	2	3488153	1973	20	2	C221500	1990	50	3	C221500	1990
7.5	2	3801458	1974	22 (200)	2	1292910	1960	60	3	1303411	1960
7.5	2	4087015	1975	22 (200)	2	1339948	1961	60	3	6428681	1984
7.5	2	4314385	1976	25	2	1467499	1962	60	3	6609651	1985
7.5	2	4691222	1977	25	2	5705532	1980-81	60	3	A197392	1986
7.5	2	4851693	1978	25	2	5942041	1982	60	3	B110789	1987
7.5	2	5226935	1979	25	2	6185159	1983	60	3	B239242	1988
7.5	2	5524660	1980-81	25	2	6453343	1984	60	3	B396036	1989
7.5	2	5936301	1982	25	2	6593849	1985	60	3	C221500	1990
7.5	2	6239857	1983	25	2	A911346	1986	65	4	1542745	1963
7.5	2	6430041	1984	25	2	B114231	1987	65	4	1606282	1964
7.5	2	6611886	1985	25	2	B238464	1988	65	4	1765044	1965
8	2	A197112	1986	25	2	B385500	1989	65	4	1869564	1966
8	2	B114231	1987	25	2	C221500	1990	65	4	2119749	1967
8	2	B233200	1988	35	4	1570507	1963	65	4	2309311	1968
8	2	B385500	1989	35	2	1628795	1964	65	4	2503991	1969

MERCURY FUERABORDA

HP	CIL	DESDE	AÑO	HP	CIL	DESDE	AÑO	HP	CIL	DESDE	AÑO
65	4	2803562	1970	90	3	B110054	1987	150	6	3752620	1974
65	4	2997339	1971	90	3	B240451	1988	150	6	4125985	1975
65	3	3293184	1972	90	3	C100000	1989	150XS	6	4319880	1976
65	3	3547987	1973	90	3	C221500	1990	150XS	6	4602012	1977
65	3	3807833	1974	90cc	2	A907702	1986	150XS	6	4868648	1978
65	3	4136685	1975	90cc	2	B114221	1987	V-150	6	4868998	1978
65	3	4382057	1976	95	6	1869776	1966	V-150	6	5129480	1979
70	3	1296411	1960	95	6	2097280	1967	V-150	6	5503247	1980-81
70	3	1413611	1961	100	6	1503332	1962	V-150	6	5944791	1982
70	3	1503459	1962	100	6	1518384	1963	V-150	6	6220254	1983
70	3	4382057	1976	100	6	1665002	1964	V-150	6	6443213	1984
70	3	4571652	1977	100	6	1755459	1965	V-150	6	6616991	1985
70	3	4825249	1978	100	6	2318586	1968	V-150	6	A904646	1986
70	3	5128280	1979	100	6	2484633	1969	V-150	6	B116662	1987
70	3	5579017	1980-81	100	4	B209468	1988	V-150	6	B242881	1988
70	3	5974683	1982	100	4	C100000	1989	V-150	6	C100861	1989
70	3	6279960	1983	100	4	C221500	1990	V-150	6	C221500	1990
70	3	B110054	1987	102cc	2	A819211	1988	V-150XR2	6	A905191	1986
70	3	B240451	1988	102cc	2	A837101	1989	V-150XR2	6	B289430	1988
70	3	C100000	1989	110	6	B170204	1966	V-150XR4	6	B242885	1988
75	4	6432901	1984	110	6	2097385	1967	V-175	6	4301235	1976
75	4	6613221	1985	115	6	2836019	1970	V-175	6	4563802	1977
75	4	A197882	1986	115	6	3023086	1971	V-175	6	4838074	1978
75	3	C100000	1989	115	6	3270480	1972	V-175	6	5180109	1979
75	3	C221500	1990	115	6	3525441	1973	V-175	6	5488752	1980-81
80	4	1335465	1960	115	6	3761035	1974	V-175	6	6618751	1985
80	4	1398630	1961	115	6	4112635	1975	V-175	6	A918329	1986
80	4	2559001	1969	115	6	4310785	1976	V-175	6	B116662	1987
80	4	2783253	1970	115	6	4567952	1977	V-175	6	B241881	1988
80	4	2986444	1971	115	6	4855153	1978	V-175	6	C100861	1989
80	4	3186263	1972	115	6	5168574	1979	V-175	6	C221500	1990
80	4	4831999	1978	115	6	5600967	1980-81	V-200	6	4839034	1978
80	4	5141097	1979	115	6	6006834	1982	V-200	6	5158929	1979
80	4	5582562	1980-81	115	6	6262961	1983	V-200	6	5464486	1980-81
80	4	5987161	1982	115	6	6440183	1984	V-200	6	6073192	1982
80	4	6232941	1983	115	6	6630171	1985	V-200	6	6203991	1983
80	3	A966142	1987	115	6	A907777	1986	V-200	6	6435503	1984
80	3	B240451	1988	115	6	B117567	1987	V-200	6	6625221	1985
80	3	C100000	1989	115	6	B239242	1988	V-200	6	A913228	1986
85	6	1460999	1963	115	4	C100000	1989	V-200	6	B116662	1987
85	6	1648888	1964	115	4	C221500	1990	V-200	6	B241881	1988
85	4	3493913	1973	125	6	2314956	1968	V-200	6	C100861	1989
85	4	3865695	1974	125	6	2536210	1969	V-200	6	C221500	1990
85	4	4092965	1975	135	6	2839369	1970	210cc	2	A918999	1986
85	4	4590512	1977	135	6	3036066	1971	210cc	2	B114231	1987
85XS	4	4366802	1976	V-135	6	A909997	1986	210cc	2	B233405	1988
90	6	1755444	1965	V-135	6	B116662	1987	210cc	2	B385500	1989
90	6	4854301	1978	V-135	6	B241881	1988	V-220	6	B241881	1988
90	6	5160324	1979	V-135	6	C100861	1989	V-225	6	5615282	1980-81
90	6	5594657	1980-81	V-135	6	C221500	1990	V-250	6	C139860	1989
90	6	5996390	1982	140	6	3293234	1972	V-250	6	C221500	1990
90	6	6246856	1983	140	6	4865678	1978	V-275	6	C139860	1989
90	6	6436123	1984	140	6	5189788	1979	V-275	6	C221500	1990
90	6	6623151	1985	140	6	5625108	1980-81	V-300	6	5611648	1980-81
90	6	A902436	1986	150	6	3502806	1973	V-300	6	6239853	1983



**18-5007
KIT ENCENDIDO**

—CONTIENE—

Ref #	O.E. #	Descripción
18-5153	398-174	Juego de contacto
18-5206	398-693	Condensador



**18-5012
KIT ENCENDIDO**

—CONTIENE—

Ref #	O.E. #	Descripción
18-5148	394-1100A3	Juego de contacto
18-5169	394-1130A1	Condensador



**18-5139
JUEGO DE CONTACTOS**

Reemplaza: 336-4318A2, 336-4318A4, 336-4318A3, 336-3948A3, 336-3948A2
(2) 18-5139 = (1) 336-4318A2



18-5140
JUEGO CONTACTOS
Reemplaza: 398-2202



18-5148
JUEGO DE CONTACTOS
Reemplaza: 394-1100A3, 394-1100A2, 394-352A1



18-5153
JUEGO DE CONTACTOS
Reemplaza: 398-174



18-5169
CONDENSADOR
Reemplaza: 394-1130A1, 394-1130, 397-741, 397-359



18-5206
CONDENSADOR
Reemplaza: 398-693



18-5207
CONDENSADOR
Reemplaza: 398-713



18-5187
BOBINA ENCENDIDO
Reemplaza: 339-856991A1, 339-850227
Para: Mariner 200DFI, 225DFI, V135DFI (2.5L), V150DFI (2.5L) y Mercury 3.0DFI



18-5180
BOBINA ENCENDIDO
Reemplaza: 392-825101T, 392-825101
Para: 40/45/50 4-tiempos



18-5182
BOBINA ENCENDIDO
Reemplaza: 823033
Para: 2.5/3/3.3 HP



18-5185
BOBINA ENCENDIDO
Reemplaza: 16064A1, 815113T02
Para: 4/5 HP



18-5178
BOBINA ENCENDIDO
Reemplaza: 398-173, 398-716



①18-5181D Display Package
18-5181
BOBINA ENCENDIDO
Reemplaza: 802371A1



①18-5186D Display Package
18-5186
BOBINA ENCENDIDO
Reemplaza: 339-7370A13, 339-832757A4



18-5433
BOBINA ENCENDIDO
Reemplaza: 32193A2, 38547, 392-806529A1, 898253T24
(Utiliza una resistencia externa)



18-23205
BOBINA ENCENDIDO
Reemplaza: 339-859738T1
Para: Mercury 25 4-Tiempos(G590000-P016999), 40 4-tiempos 4 cil(T178500-T598999), 50 4-tiempos 4 cil(T178500-T598999), 60 4-tiempos 4 cil(T178500-T598999)



18-25400
BOBINA
Reemplaza: 16066004
Para: Mercury 8/9.4-tiempos(R042475 & sup)

① Referencias acabadas en D envasadas



18-25513
BOBINA
Reemplaza: 803844T01
Para: Mercury 8/9.9 4-tiempos (R042475 & Sup)



18-5775
CAJA INTERRUPTOR
Reemplaza: 332-7778A6, 332-7778A9, 332-7778A12, 332-7778A7, 332-7778A3, 332-7778A1, 332-5524A1, F7778A9, F749301



18-5776
CAJA INTERRUPTOR
Reemplaza: 339-7452A3, 339-7452A2, 339-7452A1



18-5777
CAJA INTERRUPTOR
Reemplaza: 339-7452A15, 339-7452A19, 339-7452A9, 339-7452A7



18-5778
CAJA INTERRUPTOR
Reemplaza: 339-7452A14, 339-7452A21, 339-7452A11, 339-7452A8



18-5786
CONEXIÓN CAJA INTERRUPTOR
Reemplaza: 332-4911A2
Para: 20 HP



18-5788
CONEXIÓN CAJA INTERRUPTOR
Reemplaza: 339-6222A8
Para: 4 HP



18-5790
CONEXIÓN CAJA INTERRUPTOR
Reemplaza: 18495A26, 18495A19, 18495A12
Para: 75-90 HP



18-5791
CONEXIÓN CAJA INTERRUPTOR
Reemplaza: 19052A8, 19052A5, 19052A3
Para: 50-60 HP



18-5792
CONEXIÓN CAJA INT.
Reemplaza: 16061T
Para: 4/5 HP



18-5793
CONEXIÓN CAJA INTERRUPTOR
Reemplaza: 823034, 823034T
Para: 2.5/3.3 HP



18-5881
CAJA INTERRUPTOR
Reemplaza: 332-5772A7, 332-5772A5, 332-5772A3, 332-5772A2, 332-5772A1, F720301



18-1151
COJINETE ROTOR
Reemplaza: 30-20066
SKF Francia R822T



18-1152
COJINETE ROTOR
Reemplaza: 30-26379
SKF Francia 6002-2 RSI/HT

HP	MODELO	DESDE Nº DE SERIE	HASTA Nº SERIE	JUEGO DE CONTACTOS	CONDENSADOR	KIT ENCENDIDO	BOBINA	CAJA ENCENDIDO
2 TIEMPOS								
2.2M		A8075603	& sup.	—	—	—	—	—
2.5		A855097	& sup.	—	—	—	—	—
2.5 CD IGN		A855097	& sup.	—	—	—	18-5182	—
3 CD IGN		A855097	& sup.	—	—	—	18-5182	—
3.3		D901217	& sup.	—	—	—	18-5182	—
3.5		358136	359615	—	—	—	—	—
3.6		540657	& sup.	—	—	—	—	—
3.9		1655013	2498155	18-5140	18-5212	18-5008	—	—
4		2498136	2693114	18-5140	18-5212	18-5008	—	—
4	⑧	2771622	A809600	18-5139	—	—	—	—
4		A809601	& sup.	—	—	—	—	—
4 (2 cil.prod. de USA)		5589202	& sup.	—	—	—	—	18-5788
4		G710613	& sup.	—	—	—	—	18-5792
4.5		4107220	& sup.	18-5139	—	—	—	—
5	⑤	338136	& sup.	—	—	—	18-5178	—
5	⑦	338136	& sup.	—	—	—	—	—
5 PHELON		574128	786612	—	—	—	18-5185	—
5		A809601	& sup.	—	—	—	—	—
5.9 (Mark 6) (Phelon)		888005	1134535	—	—	—	18-5178	—

① Necesarias 2 unids ② Necesarias 3 unids ③ Necesarias 4 unids ④ Necesarias 6 unids ⑤ Sólo Phelon Magneto ⑥ Sólo arranque manual
 ⑦ Sólo Bendix Scintilla Magneto ⑧ Excepto "Gnat" N/A No Aplicable
 ⑨ Para caja de encendido con conexiones tuerca standard use 18-5776 – Para caja de encendido con conexiones tipo bala use 18-5777
 ⑩ Para caja de encendido con conexiones tuerca standard use 18-5776 – Para caja de encendido con conexiones tipo bala use 18-5778

HP	Modelo	Desde nº de serie	Hasta nº de serie	Juego de contactos	Condensador	Kit Encendido	Bobina	Caja Encendido
6	⑤	1184570	& Sup	—	—	—	18-5178	—
6		1408611	1610264	—	—	—	18-5178	—
6		1610265	2529894	18-5140	18-5212	18-5008	—	—
6		A197112	G760299	—	—	—	18-5186 ①	18-5777
6		G760300	T800749	—	—	—	18-5186	—
7.5	⑤	214324	& Sup	18-5153	18-5207	—	18-5178	—
7.5		2529895	2721150	18-5140	18-5212	18-5008	—	—
7.5		3274633	3801457	18-5139	—	—	—	—
7.5		3801458	& Sup	—	—	—	—	—
8		A197112	G760299	—	—	—	18-5186 ①	18-5777
8		A760300	& Sup	—	—	—	18-5186	18-5777
9.8		1470349	1865778	18-5153	18-5206	18-5007	18-5178	—
9.8		1865776	2708898	18-5140	18-5212	18-5008	—	—
9.8		2798057	3263262	18-5139	—	—	—	—
9.8		3263263	3795657	18-5139	—	—	—	—
9.8		3795658	& Sup	—	—	—	—	—
210CC	Sail Power	A918999	& Sup	—	—	—	18-5186 ①	18-5777
9.9		A197112	G760299	—	—	—	18-5186 ①	18-5777
9.9		G760300	& Sup	—	—	—	18-5186	18-5777
10	PHELON			—	—	—	18-5178	—
10		1120828	112327	18-5153	18-5206	18-5007	18-5178	—
10		595628	112327	18-5153	18-5206	18-5007	18-5178	—
10		595628	& Sup	18-5153	18-5206	18-5007	18-5178	—
10		D038000	G760299	—	—	—	—	18-5777
15		1200114	1499331	18-5153	18-5206	18-5007	18-5178	N/A
15		B292414	G760299	—	—	—	18-5186 ①	18-5777
15		G760300	& Sup	—	—	—	18-5186	18-5777
15	SEA PRO	G044027	G437999	—	—	—	18-5186	—
15		G438000	G760299	—	—	—	18-5186	18-5777
15		G760300	& Sup	—	—	—	18-5186	—
15	COMM	G760300	& Sup	—	—	—	18-5186	—
15	NON COM	G760300	& Sup	—	—	—	18-5186	—
15XD	COMM	G760300	& Sup	—	—	—	18-5186	—
15XD	NON COMM	760300	& Sup	—	—	—	18-5186	—
18		5837437	6443972	—	—	—	18-5186 ①	18-5776
18		6443973	& Sup	—	—	—	18-5186 ①	⑨
18 BULLET	CONN	6443973	& Sup	—	—	—	18-5186	—
20		860979	& Sup	18-5153	18-5206	18-5007	18-5178	—
20		1558310	1592567	—	—	—	18-5178	—
20		1592568	2827676	—	—	—	—	—
20		2827677	3226957	18-5139	—	—	—	—
20		3226958	3537530	18-5139	—	—	—	—
20		3537531	3755884	—	—	—	18-5186	18-5786
20		3755884	4403786	—	—	—	—	—
20		4403787	6443972	—	—	—	—	—
20		6443973	G044026	—	—	—	18-5186 ①	18-5777
20		G044027	G437999	—	—	—	18-5186	—
20		G438000	G760299	—	—	—	18-5186 ①	18-5777
20	COMM	G760300	T800999	—	—	—	18-5186	—
20 NON	COMM	G760300	T800999	—	—	—	18-5186	—
20 JET		G044027	G760299	—	—	—	18-5186	—
20 JET		G760300	& Sup	—	—	—	18-5186	—
22		1158546	1499331	18-5153	18-5206	18-5007	18-5178	—
25 KF9		377150	379008	18-5148	18-5169	18-5012	—	—
25 KG9		377150	379008	18-5148	18-5169	18-5012	—	—
25 MARK40		377150	379008	18-5148	18-5169	18-5012	—	—
25		5705532	6443972	—	—	—	18-5186 ①	18-5776
25	NUT	6443973	& Sup	—	—	—	18-5186 ①	⑨
25	BULLET	6443973	& Sup	—	—	—	18-5186	—
25		B238464	G044026	—	—	—	18-5186 ①	18-5777
25		G04027	G437999	—	—	—	18-5186	—
25		G438000	G760299	—	—	—	18-5186	—
25	COMM	G760300	& Sup	—	—	—	18-5186	—
25	NONCOMM	G760300	& Sup	—	—	—	18-5186	—
25		E268781	& Sup	—	—	—	—	—
30	MK 30 55			—	18-5169	—	—	—
30		1271884	1448139	—	18-5169	—	—	—
30		G053314	G380074	—	—	—	—	—
30		G380075	G589999	—	—	—	—	—
30		G590000	T598999	—	—	—	—	—
30	Jet	C159200	G589999	—	—	—	18-5186 ①	18-5881
30	JET	G590000	T178499	—	—	—	—	—
35	350	1271884	1448139	18-5148	18-5169	18-5012	—	—
35	35A	1271884	1448139	—	18-5169	—	—	—
35		1571114	2874703	18-5140	18-5212	18-5008	—	—
35	NUT	6445653	B110788	—	—	—	18-5186 ①	⑩
35	BULLET	6445653	B110788	—	—	—	18-5186 ①	18-5778
35		B110789	& Sup	—	—	—	18-5186	18-5778
40		831021	1279684	18-5148	18-5169	18-5012	—	—
40		1279685	1476509	—	18-5169	—	—	—
40		3336258	3859434	—	—	—	18-5186	—
40 (2 cil.)		3859435	5823917	—	—	—	18-5186	—
40 (2CIL)		3859435	5823917	—	—	—	—	—
40 (2 cil.)		5823918	6443973	—	—	—	18-5186 ①	18-5776
40 (2CIL)		G053314	G380074	—	—	—	—	—
40 (2CIL)		G380075	G589999	—	—	—	—	—
40 (2CIL)		G590000	& Sup	—	—	—	—	—
40 (3CIL)		G531301	T999999	—	—	—	—	—
40 LIGHT		N000513	& Sup	—	—	—	—	—
40XR	LIGHTING	N000513	& Sup	—	—	—	—	—
40 (4 cil.)		C159200	& Sup	—	—	—	18-5186 ③	18-5881
40	JET	T178500	& Sup	—	—	—	—	—
45		1139538	& Sup	18-5148	18-5169	18-5012	—	—
45		1476510	1531958	—	18-5169	—	—	—
45/50 (4 cil.)		5531630	& Sup	—	—	—	18-5186 ③	18-5881
45 (3CIL)	JET	G290584	G589999	—	—	—	18-5186	—

① Necesarias 2 unids ② Necesarias 3 unids ③ Necesarias 4 unids ④ Necesarias 6 unids ⑤ Sólo Phelon Magneto ⑥ Sólo arranque manual
 ⑦ Sólo Bendix Scintilla Magneto ⑧ Excepto "Gnat" N/A No Aplicable
 ⑨ Para caja de encendido con conexiones tuerca standard use 18-5776 – Para caja de encendido con conexiones tipo bala use 18-5777
 ⑩ Para caja de encendido con conexiones tuerca standard use 18-5776 – Para caja de encendido con conexiones tipo bala use 18-5778

HP	Modelo	Desde nº de serie	Hasta nº de serie	Juego de Contacto	Condensador	Kit Encendido	Bobina	Caja Encendido
45 JET		G760300	T178499	—	—	—	18-5180	—
45 4 TIEMPOS		G231123	T178499	—	—	—	18-5180	—
50		1421113	2305100	—	18-5169	—	—	—
50		1770179	2116317	—	18-5169	—	—	—
50	⑥	2116318	2305100	—	18-5169	—	—	—
50		2305101	2858813	—	—	—	—	—
50 (4CIL)		2858814	4140999	—	—	—	—	—
50 (4CIL)		4141000	4357639	—	—	—	—	—
50 (4CIL)		4357640	5193258	—	—	—	—	—
50 (4CIL)		5193259	5531629	—	—	—	18-5186	18-5881
50 (4CIL)		5531630	& Sup	—	—	—	18-5186	18-5881
50 4-tiempos & Bigfoot		G231123	T178499	—	—	—	18-5180	—
50/60 (3 cil.)		6428681	D000749	—	—	—	18-5186 ②	18-5775
50/55/60 (3 cil.)		D000750	G589999	—	—	—	18-5186 ②	18-5791
50 (3CIL)		G590000	T999999	—	—	—	—	—
55 (3CIL)		D000750	G589999	—	—	—	18-5186	—
55 (3CIL)		G590000	G760299	—	—	—	—	—
55 (3CIL)		G760300	& Sup	—	—	—	—	—
60 MK75		1072997	& Sup	—	—	—	—	—
60 (6CIL)		1303411	1542744	—	—	—	—	—
60 (3CIL)		6428681	D000749	—	—	—	18-5186	18-5775
60 (3CIL)		D000750	G589999	—	—	—	18-5186	—
60 (3CIL)		G590000	G760299	—	—	—	—	—
60 (3CIL)		G760300	& Sup	—	—	—	—	—
65 (4CIL)		1542745	2309310	—	18-5169	—	—	—
65 (4CIL)	650	2309311	2803561	—	—	—	—	—
65 (4CIL)	650E	2309311	2803561	—	—	—	—	—
65 (4CIL)		2803562	2874263	—	—	—	—	—
65 (4CIL)		2997339	3293183	—	—	—	—	—
65 (3CIL)	3 3/8 COIL	3293184	3525440	—	—	—	—	—
65 (3CIL)	2 7/8 COIL	3293184	3525440	—	—	—	—	—
65 (3CIL)		4382057	4571651	—	—	—	—	18-5775
65 (3CIL)		3547987	4382056	—	—	—	—	—
65 JET		G438000	& Sup	—	—	—	—	—
65 jet		D283222	G437999	—	—	—	18-5186	—
70	MK75,78	1110600	& Sup	—	—	—	18-5433	—
70 (6CIL)		1296411	1566239	—	—	—	18-5433	—
Merc 70		4571652	5128279	—	—	—	—	18-5775
Mariner70		5128280	& Sup	—	—	—	18-5186 ②	18-5775
70		1296411	1566239	—	—	—	18-5433 ①	—
70		5579016	6428680	—	—	—	18-5186 ②	18-5775
70/75 (3 cil.)		C272000	D283221	—	—	—	18-5186 ②	18-5775
75 (3 cil.)		D283222	G437999	—	—	—	—	18-5790
75 (4 cil.)		6432901	& Sup	—	—	—	18-5186 ③	18-5881
75 (3CIL)		C222000	D283221	—	—	—	18-5186	18-5775
75 (3CIL)		D283222	G437999	—	—	—	18-5186	—
75 (3CIL)		G438000	& Sup	—	—	—	—	—
75 (3CIL)	OPTIMAX	T801000	& Sup	—	—	—	—	—
80		1335465	1566239	—	—	—	18-5433 ①	—
Mariner 80 (4cil.)		5144547	& Sup	—	—	—	18-5186 ③	—
Merc 80 (4cil.)		5582562	6432900	—	—	—	18-5186 ③	—
80		2559001	3493912	—	—	—	—	—
80 (4 cil.)		4831999	5141096	—	—	—	—	18-5881
80 (4 cil.)		5141097	6432900	—	—	—	18-5186	18-5881
80 (3 cil.)		A996142	& Sup	—	—	—	18-5186 ②	18-5775
80 Jet		D283222	G437999	—	—	—	—	18-5881
80JET		G438000	& Sup	—	—	—	—	—
85 (6cil)		1460999	1766823	—	—	—	18-5433 ①	—
85 (4cil)		3493913	3865694	—	—	—	—	—
85 (4cil)		3865695	4366801	—	—	—	—	—
85 (4 cil.)		4366802	4831998	—	—	—	—	18-5881
90		1766824	1869775	—	—	—	18-5433 ①	—
90		4845301	5299505	—	—	—	—	—
90 (6 cil.)		5299506	& Sup	—	—	—	18-5186 ④	18-5775 ①
90 (3 cil.)		A996142	D283221	—	—	—	18-5186 ②	18-5775
90 (3 cil.)		D283222	G437999	—	—	—	18-5186	18-5790
90 (Powerhead)	Sport Jet	E023150	E095087	—	—	—	18-5775	—
90 (3CIL)		G438000	& Sup	—	—	—	—	—
90 OPTIMAX		T801000	& Sup	—	—	—	—	—
95		1869776	1935100	—	—	—	18-5433 ①	—
95		1935101	2318585	—	—	—	—	—
100 (6 cil.)		1464949	2318585	—	—	—	18-5433 ①	—
100 (6CIL)		2318586	2536018	—	—	—	—	—
100 (6CIL)		2399698	2641854	—	—	—	—	—
100 (6CIL)		2641855	3253111	—	—	—	—	—
100 (4 cil.)		B209468	G437999	—	—	—	18-5186 ③	18-5881
100 (4CIL)		G438000	& Sup	—	—	—	—	—
105 Jet		D082000	G303045	—	—	—	18-5186 ④	18-5775 ①
110		1870204	2314955	—	—	—	18-5433 ①	—
115 (6CIL)		5314656	& Sup	—	—	—	18-5186 ④	18-5775 ①
115 (6CIL)		2836019	2928720	—	—	—	—	—
115 (6CIL)		2928721	4112634	—	—	—	—	—
115 (6CIL)		4112635	5314655	—	—	—	—	—
115 (6CIL)		5314656	& Sup	—	—	—	18-5186	—
115 (4CIL)		B209468	6437999	—	—	—	18-5186 ③	—
115 (4CIL)		G438000	& Sup	—	—	—	—	—
115 (3CIL)	OPTIMAX	T801000	& Sup	—	—	—	—	—
115 (3CIL)	PRO XS	B751825	& Sup	—	—	—	—	—
115 (3CIL)		C100000	G437999	—	—	—	—	18-5881
125 (4CIL)		D283222	G437999	—	—	—	18-5186	18-5881
125 (6CIL)		2314956	2839368	—	—	—	—	—
125 (6CIL)		2400058	2641854	—	—	—	—	—
125 (6CIL)		2641855	3253111	—	—	—	—	—
125 (4CIL)		G438000	& Sup	—	—	—	—	—
125 (3CIL)	OPTIMAX	B736885	& Sup	—	—	—	—	—

① Necesarias 2 unids. ② Necesarias 3 unids ③ Necesarias 4 unids ④ Necesarias 6 unids ⑤ Sólo Phelon Magneto ⑥ Sólo arranque manual
 ⑦ Sólo Bendix Scintilla Magneto ⑧ Except "Gnat" N/A No Aplicable
 ⑨ Para caja de encendido con conexiones tuerca standard use18-5776 – Para caja de encendido con conexiones tipo bala use18-5777
 ⑩ Para caja de encendido con conexiones tipo bala use18-5776 – Para caja de encendido con conexiones tipo bala use18-5778

HP	Modelo	Desde n° de serie	Hasta n° de serie	Juego de contactos	Condensador	Kit encendido	Bobina	Caja Encendido
135		2839369	3293233	—	—	—	—	—
V-135		A904646	& Sup	—	—	—	18-5186 ④	18-5775 ①
140		3293234	3502805	—	—	—	—	—
140		4865678	5327662	—	—	—	—	—
140		5327663	& Sup	—	—	—	18-5186 ④	18-5775 ①
140 Jet		D082000	G960499	—	—	—	18-5186 ④	18-5775 ①
150		3502806	4865677	—	—	—	—	—
150 XS		4868648	5327662	—	—	—	—	—
150	V135	A904646	G960499	—	—	—	18-5186	18-5775
150	V135	G960500	T178499	—	—	—	—	—
V-150	ORGOIL	4868998	A904645	—	—	—	—	18-5775 ①
V-150	BLUCOIL	4868998	A904645	—	—	—	18-5186	—
V-150		5129480	G960499	—	—	—	18-5186 ④	18-5775 ①
V-150 XR2		6616991	A904645	—	—	—	18-5186 ④	18-5775 ①
V-150 XR4		B242885	D819999	—	—	—	18-5186 ④	18-5775 ①
V-150		G960500	& Sup	—	—	—	—	—
V-150 XR6		D082000	T408999	—	—	—	—	①
V-150	EFI	T409000	& Sup	—	—	—	—	—
V-150	DFI	G590000	B490865	—	—	—	18-5187	—
V-150	DFI	B490866	& Sup	—	—	—	—	—
V-150	PRO XS	B690542	& Sup	—	—	—	—	—
V-175		4301235	5180108	—	—	—	—	18-5775 ①
V-175,EFI, XR1		5180109	G960499	—	—	—	18-5186 ④	18-5775 ①
V-175 EFI		D000750	G960499	—	—	—	18-5186	—
V-175 EFI		G960500	T408999	—	—	—	—	—
V-175 EFI		T409000	T800999	—	—	—	—	—
V-175 DFI		T178500	B490865	—	—	—	18-5187	—
V-175 DFI		B490866	& Sup	—	—	—	—	—
V-175 PRO		B516339	& Sup	—	—	—	—	—
V-200	ORGOIL	4839034	5363917	—	—	—	—	①
v-200	BLUCOIL	4839034	5363917	—	—	—	—	—
V-200, XR1		5363918	G960499	—	—	—	18-5186 ④	18-5775 ①
v-200		G960500	& Sup	—	—	—	—	—
V-200 EFI		C100861	G960499	—	—	—	18-5186	—
V-200 EFI		G303046	T408999	—	—	—	—	—
V-200 EFI	2.5L	T409000	& Sup	—	—	—	—	—
V-200 EFI	3.0L	T750164	& Sup	—	—	—	—	—
V-200 DFI		G386496	G589999	—	—	—	18-5183	—
V-200 DFI		G590000	B504988	—	—	—	18-5187	—
V-200 DFI		B504989	& Sup	—	—	—	—	—
V-200 PRO		B504989	& Sup	—	—	—	—	—
V-220		B117316	& Sup	—	—	—	18-5186 ④	18-5775 ①
V-225	2.4L	5628028	& Sup	—	—	—	18-5186 ④	18-5775 ①
V-225	3.0L	D280813	G303045	—	—	—	—	—
V-225	3.0L	G303046	T408999	—	—	—	—	—
V-225	3.0L	G245605	G303045	—	—	—	—	—
V-225	3.0L	G303046	T408999	—	—	—	—	—
V-225 EFI	3.0L	G129222	G303045	—	—	—	—	—
V-225 EFI	3.0L	G303046	T408999	—	—	—	—	—
V-225 EFI	3.0L	T409000	& Sup	—	—	—	—	—
V-225 DFI		G590000	B504988	—	—	—	18-5187	—
V-225		B504989	& Sup	—	—	—	—	—
V-225 PRO		B104549	B426650	—	—	—	18-5187	—
V-225 PRO		B426561	& Sup	—	—	—	—	—
V-250 EFI	3.0L	G129222	T408999	—	—	—	—	—
V-250 EFI	3.0L	T409000	& Sup	—	—	—	—	—
V-250	3.4L	C101891	& Sup	—	—	—	18-5186	—
V-250 DFI		B528615	& Sup	—	—	—	—	—
V-250 PRO		B426561	& Sup	—	—	—	—	—
V-275	3.4L	C101891	& Sup	—	—	—	18-5186	—
V-300	3.4L	5611648	& Sup	—	—	—	18-5186	—

- ① Necesarias 2 unids. ② Necesarias 3 unids. ③ Necesarias 4 unids. ④ Necesarias 6 unids. ⑤ Sólo Phelon Magneto ⑥ Sólo arranque manual
 ⑦ Sólo Bendix Scintilla Magneto ⑧ Excepto "Gnat" N/A No aplicable
 ⑨ Para caja de encendido con conexiones tuerca standard use 18-5776 – Para caja de encendido tipo bala use 18-5777
 ⑩ Para caja de encendido con conexiones tuerca standard use 18-5776 – Para caja de encendido tipo bala use 18-5778

CABLES DE BUJÍAS DE ALTO RENDIMIENTO

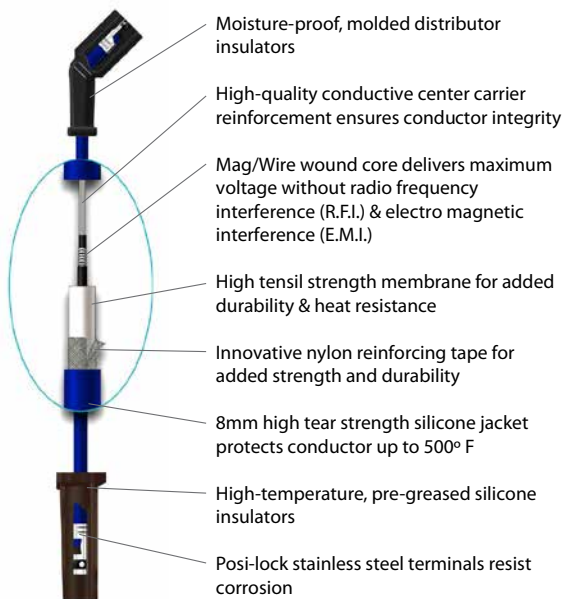

Los cables de bujías Sierra protegen de interferencias los dispositivos electrónicos. Fácil instalación y libre de mantenimiento.



Referencia	OEM #	Descripción
18-8819-1	—	Cable de bujía 18 cm (8mm)
18-5228-1	—	Cable de bujía 23 cm (8mm)
18-5228-1D③	84-813715A1	Cable de bujía 23 cm (8mm)
★ 18-5227-1	—	Cable de bujía 23 cm (7mm)
18-5227-1D②③	84-813715A1	Cable de bujía 23 cm (7mm)
18-5229-9-1①②	—	Cable de bujía 56 cm (7mm)
18-5230-9-1①②	—	Cable de bujía 25 cm(7mm)

★ Cable de alma metálica ① pack de 5 ② 7mm alma de cobre
 ③ Referencias acabadas en D envasadas



18-5225
KIT CABLE BUJÍAS
 Reemplaza:
 84-99215A26, 84-813706A26, 84-93475A26, 84-93212A1,
 84-90816A26
 Kit incluye 25 ft. de cable de encendido 7 MM Hypalon con conductor de cobre y un largo surtido de 3 terminales diferentes para motores fueraborda.



18-5226
CABLE ENCENDIDO
 Interior metálico
 30 mts Bobina
 7mm Hypalon



18-5511
JUEGO DE CABLEADO INTERNO
 Reemplaza: 84-822253A20,
 45876-20, 84-822253T20



18-5224
18-5224-9①
TERMINAL CABLE BUJÍAS
 Reemplaza: 20121, 8M0084600



18-5750
18-5750-9①
TAPA DE BUJÍAS UNIVERSAL
 Suministrado completo con conector terminal



18-5752
BUJÍA UNIVERSAL
 8mm



18-28080
JUEGO DE CABLES
 Reemplaza: 84-821945A56
 Para: 225(3.0L Carb) y 225/250(3.0L EFI)
 (G303045 & Inf.)



18-28081
JUEGO DE CABLES
 Reemplaza: 84-813706A56
 Para: 225(3.0L Carb) y 225/250(3.0L EFI) w/CDM Modulos (G303045 & sup.)



18-28082
JUEGO DE CABLES
 Reemplaza: 84-813715A8
 Para: 100, 115, 125 & 80 Jet(4 cil)
 (G301751 & Sup)



18-28083
CABLE BUJÍA
 Reemplaza: 84-881908T
 (1 cable)
 Para: Mercury V6 EFI/DFI/DTS



18-28084
JUEGO DE CABLES BUJÍA
 Reemplaza: 84-881908T
 (3 cables)
 Para: Mercury 30-40 EFI 4-tiempos(3 cil)



18-28085
JUEGO DE CABLES BUJÍA
 Reemplaza: 84-881908T
 (4 cables)
 Para: Mercury 40-6- EFI 4-tiempos (4 cil)



18-28086
JUEGOS DE CABLE BUJÍA
 Reemplaza: 84-881908T
 (6 cables)
 Para: Mercury V6 EFI/DFI/DTS



MP41000
LLAVE DE ENCENDIDO
 Pulse para arrancar –
 3 Posiciones— 6 Terminales
 Reemplaza: 87-88107, 87-88107A5



MP41070-2
LLAVE DE ENCENDIDO
 Pulse para arrancar –
 3 Posiciones— 6 cables
 Reemplaza: 87-17009A2



MP51090 (Display)
MP51092
LLAVE DE ENCENDIDO
 3 Posiciones Magneto – OFF- RUN-
 Pulse para arrancar
 Reemplaza: 87-17009A5



MP52000 (Display Pkg.)
MP52002
LLAVE DE ENCENDIDO
 3 Posiciones Magneto – OFF- RUN-
 Pulse para arrancar – 8 cables
 Reemplaza: 87-88107A5



18-6751
VÁLVULA
 Reemplaza: 893929A01, 813442A2,
 813442A1, 811618A1, 811618,
 812843A1, 99660A1
 Para: Mayoría de 2x4 tiempos con trim y
 tilt integral.



18-6771
DEPÓSITO TILT/TRIM
 Reemplaza: 18525A1

① Precio por pack

18-6778
DEPÓSITO TILT/TRIM
Reemplaza: 88316A1

Para: Motors con 4 tornillos de anclaje



(2 cables con reles)

18-6273-1
MOTOR TILT/TRIM

Bomba en cartucho de altas prestaciones con motor reemplazable

Reemplaza: 99186, 99186-1, 99186-T

Para: 35-220 HP (1985-93) Fuerabordas Mercury/Mariner con Design I, 3 Ram, 3 Cables, unidades Tilt/Trim con depósito Trim/Tilt Use relé 18-5737



18-6757
MOTOR TILT/TRIM

Para: Mercury 35-220 HP (1985-92) con diseño I, 3-Ram Llenado lateral Trim/Tilt Sistema tipo cuadrado Motor y 18-6273-1 Tilt/Trim Montaje de bomba de motor Usar cableado 18-6823



18-6763
MOTOR TILT/TRIM

Reemplaza: 92975A28, A32
Para 1984 y mayoría Mercury (Sólo motor y depósito)

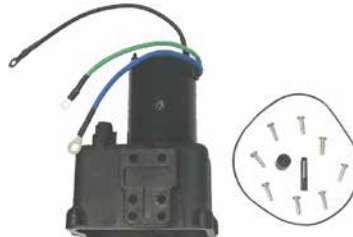

18-6765
MOTOR TILT/TRIM

Reemplaza: 823653A5, 92459A4, 823653A9
Para: 250,275 HP & V-3.4L, N° serie.5611648-sup (Sólo Motor)
Reemplaza: 17649A02



18-6773
MOTOR TRIM

Reemplaza: 828708, 878265A4
Para últimos modelos Mercury/Mariner 1996 & sup (135,150, XR6 Mag III, 175, 200, 225, 250 HP – 105 - 140 HP Jet)



18-6774
MOTOR TRIM

Reemplaza: 811628, 828708A1, 878265A6
Cartucho de alto rendimiento, Motor reemplazable. Design II, Ram 3, 2 cables, Unidades tilt/trim. Estilo cuadrado Eaton Use cableado 18-6823



18-6775
TILT/TRIM MOTOR
Referencia OE depósito 811673 1
Contiene: Todas las partes necesarias, Un nuevo depósito 3-cables motor/depósito, acoplamiento de eje, retén aceite, Aros y tornillería. Tapón llenado amarillo.

Para:

Modelos	Modelos
65 Jet	100 4-Cil.
75 3-Cil.	115 4-Cil.
80 Jet	125 4-Cil.
90 3-Cil.	

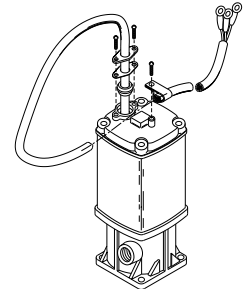

Si tiene este tipo de cable, use 18-6775

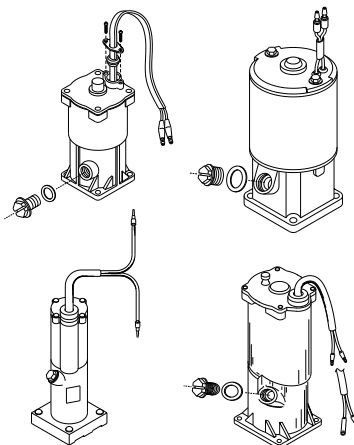

Si tiene este tipo de cables, use 18-6777

18-6777
MOTOR TILT/TRIM

Reemplaza: 818903A1, 819762A4-A7, 819479A1, 819480A1, 81977A8-A9, 822870A1, 830250A3-T3, 832021A1-T4-A2-T2, 855654A1-T2, 19217A1-A5, 854472A2, A3, A4

Contiene: Todas las partes necesarias, un nuevo depósito 2- cables motor/depósito, eje, retén aceite, Aros y tornillería. Tapón llenado amarillo. Base cuadrada.

Para:

Modelos	Modelos
30 Jet	60 3-Cil., Bigfoot
30 4-Tiempos	65 Jet
35	75 3-Cil.
40 2, 3, 4-Cil.	75 4-Tiempos
40 4-Tiempos, Bigfoot	80 Jet
45 4-Tiempos, Bigfoot, Bodensee	90 3-Cil.
	90 4-Tiempos
50 3-Cil.	100 4-Cil.
50 4-Tiempos, Bigfoot	115 4-Cil.
55 3-Cil.	125 4-Cil.



18-6448
KIT CONVERSIÓN ARRANQUE ELÉCTRICO
 Para: Mercury 30 HP

18-6274
MOTOR TILT/TRIM
 Reemplaza: 14336A20, 865380A13
 Baja presión / Alto caudal



CABLES BATERÍA
 Terminales que aceptan tornillos 3/8".

Ref.	Medida	Color	Salidas	Ref.	Talla	Color	Salidas
BC88523	2'	rojo	4	BC88563	6'	rojo	2
BC88533	2'	negro	4	BC88573	6'	negro	2
BC88543	4'	rojo	2	BC88583	8'	rojo	1
BC88553	4'	negro	2	BC88593	8'	negro	1



18-9800
TESTER COMPRESIÓN
 Idóneo para lugares de difícil acceso.



18-9801
MULTI METER/DVA TESTER
 Reemplaza: 91-99750A1
 Para sistemas de arranque mercury



18-9802
LUZ CRONOMETRAJE
 Reemplaza: 91-99379
 Hasta 10,000 RPM's.



18-5863
STATOR
 Reemplaza: 86617A17
 Para: 15-25 HP



18-5864
STATOR
 Reemplaza: 86617A20
 Para: 6-25 HP



18-5865
STATOR
 Reemplaza: 398-5704A7
 Para: 50-70 HP



18-5866
STATOR
 Reemplaza: 76314A3
 Para: 45-50 4 cil.



18-5867
STATOR
 Reemplaza: 398-9873A4
 Para: 135-200 V-6



18-5870
STATOR
 Reemplaza: 398-832075A4-A21
 Para: 30-125 HP
 Reemplazo para kits 18-5873 & 18-5874



18-5871
STATOR
 Reemplaza: 398-5454A32
 Para: 135-300 V6



18-5873
KIT STATOR
 Reemplaza: 398-832075A6
 Para: 100, 115, 125 HP
 Incluye 18-5870 stator

**18-5874
KIT STATOR**

Reemplaza: 398-832075A14, 398-832075A20,
398-818535A15, 398-5919A8, 398-5919A6,
398-5919A2, 398-5454A63, 398-5454A25,
398-5454A21
Para: 30-50 HP
Incluido 18-5870 stator



**18-5876
STATOR**

Reemplaza: 398-9610A19
Para: 135 -200 HP



**18-5854
STATOR**

Reemplaza: 398-5454A17
*Nota: cable extra negro va a toma motor.



**18-5856
STATOR**
Reemplaza: 398-5255



**18-5857
STATOR**
Reemplaza: 398-5454A7



**18-5859
STATOR**
Reemplaza: 398-5454A26, 398-5454A22, 398-5919A7, 398-5919A3



**18-5860
STATOR**
Reemplaza: 398-5454A35



**18-5796
TRIGGER**
Reemplaza: 96455A15
Para: 6 cil.



**18-5797
TRIGGER**
Reemplaza: 96455A8, 96455A1, 68162A6, 68162A3
Para: 3 cil.



**18-5798
TRIGGER**
Reemplaza: 96455A9, 96455A6, 68162A8, 68162A5, 68162A1
Para: 6 cil



APLICACIÓN EN LA SIGUIENTE PÁGINA

APLICACIONES STATOR Y TRIGGER

HP	DESDE	HASTA	Trigger	Stator	HP	DESDE	HASTA	Trigger	Stator
6	A197112	G760299	—	18-5864	125 4 cil	G438000	& Sup	—	18-5870 **
7.5	2810637	3274632	—	18-5855	125 4 cil (Belgica)	9927000	& Sup	—	18-5870 **
8	A197112	G760299	—	18-5864	125 4 cil con regulador de voltaje.	D283222	G437999	—	18-5873 **
9.8	2798057	3263262	—	18-5855	125 4 cil con regulador de voltaje				
9.9	A197112	G760299	—	18-5864	(Belgica)	9793577	9926999	—	18-5873 **
XR10,10 MAG & SEA PRO	D038000	G760299	—	18-5864	V135	A904646	C100860	18-5798	18-5860 ②
15	A197112	G760299	—	18-5864	V135	A904646	C100860	18-5798	18-5871
15 SEA PRO, SUPER 15	G044365	G437999	—	18-5863	V135	C100861	C239552	18-5798	—
15 SEA PRO, SUPER 15	G438000	G760299	—	18-5864	V135	C239553	D081999	18-5798	18-5860 ③
18	5837437	6443972	—	18-5864	V135	C239553	D081999	18-5798	—
18XD	6443973	B238463	—	18-5864	V135	C239553	D081999	18-5798	18-5867 ③⑥
20	2827677	3226957	—	18-5855	V135	D082000	G960499	18-5798	18-5876
20	6443973	G044026	—	18-5864	140	5327663	& Sup	18-5798	18-5854
20, 20 JET	G044027	G437999	—	18-5863	140 JET	UP TO	G760299	18-5798	18-5876
20, 20 JET	G438000	G760299	—	18-5864	V150	4868998	A904645	18-5798	18-5857
20XD	6443973	B238463	—	18-5864	V150	A904646	C100860	18-5798	18-5860 ②
25	5705532	6443972	—	18-5864	V150	A904646	C100860	18-5798	18-5871
25, 25 SEA PRO & MARATHON	B238464	G044026	—	18-5864	V150	C100861	C239552	18-5798	—
25, 25 SEA PRO & MARATHON	G044027	G437999	—	18-5863	V150	C239553	D081999	18-5798	18-5860 ③
25, 25 SEA PRO & MARATHON	G438000	G760299	—	18-5864	V150	C239553	D081999	18-5798	— †
25XD	5705532	G044026	—	18-5864	V150	C239553	D081999	18-5798	18-5867 ③⑥
30 2 cil modelo eléctrico	G055314	& Sup	—	18-5870 **	V150	D082000	G960499	18-5798	18-5876
30 JET 3 cil modelo eléctrico	G590000	T408999	—	18-5870 **	V150 EFI	D082000	G960499	18-5798	18-5876
30 Jet 4 cil modelo eléctrico	C159200	D055047	—	18-5874 **	V150 XRI EFI	D082000	G303045	18-5798	18-5876
35 2 cil	6445653	B110788	—	18-5864	150 XR-4	B242885	C100860	18-5798	18-5860
40 2 cil	3859435	5823917	—	18-5856 ①	150 XR-4	C100861	C239552	18-5798	—
40 2 cil encendido eléctrico	G055314	& Sup	—	18-5870 **	150 XR-4	C239553	D081999	18-5798	18-5860 ③
40 3 cil encendido eléctrico	G531301	& Sup	—	18-5870 **	150 XR-4	C239553	D081999	18-5798	— †
40 3 cil encendido eléctrico (Bélgica)	9973100	& Sup	—	18-5874 **	150 XR-4	C239553	D081999	18-5798	18-5867 ③⑥
40 4 cil encendido eléctrico	C159200	D055047	—	18-5874	150 XR-4, MAG II	C239553	D081999	18-5798	—
40 JET encendido eléctrico	T178500	& Sup	—	18-5874 **	150 XR-4, MAG II	C239553	D081999	18-5798	18-5867 ③⑥
45 4 cil sólo encendido manual	5531630	B110788	—	18-5866	150 XR-6, MAG III	D082000	G960499	18-5798	18-5876
45 4 cil modelo eléctrico	5531630	& Sup	—	18-5870	V175	4301235	6618750	18-5798	18-5857
45 JET modelo eléctrico	G590000	T129554	—	18-5874 **	V175	6618751	C100860	18-5798	18-5871 ④
50 4 cil sólo arranque manual	4357640	& Sup	—	18-5866	V175	6618751	C100860	18-5798	18-5857 ④
50 4 cil modelo eléctrico	4357640	& Sup	—	18-5870	V175	6618751	C100860	18-5798	18-5860 ⑤
50 3 cil	6428681	D000749	18-5797	18-5865	V175	C100861	C239552	18-5798	—
50, 55 3 cil encendido eléctrico	G590000	& Sup	—	18-5870 **	V175	C239553	D081999	18-5798	18-5860 ③
50 3 cil modelo eléctrico (Bélgica)	9973100	& Sup	—	18-5870 **	V175	C239553	D081999	18-5798	18-5867 ③⑥
55 3 cil modelo eléctrico	D000750	G589999	—	18-5870 **	V175	C239553	D081999	18-5798	— †
55 3 cil modelo eléctrico (Bélgica)	9741042	9973088	—	18-5870 **	V175	D082000	G960499	18-5798	18-5876
60 3 cil	6428681	D000749	18-5797	18-5865	V175 MAG, EFI	D000750	D081999	18-5798	—
60 3 cil modelo eléctrico	G590000	& Sup	—	18-5870 **	V175 EFI	D303046	G960499	18-5798	18-5876
60 3 cil modelo eléctrico (Bélgica)	9973100	& Sup	—	18-5870 **	V175 XRI EFI	D000750	D081999	18-5798	—
60 3 cil Bigfoot	G590000	G760299	—	18-5874 **	V175 XRI EFI	D082000	G303045	18-5798	18-5876
65 (650) 3 cil	4382057	4571651	—	18-5865	V200	4839034	6625220	18-5798	18-5857 ④
70 3 cil	4571652	A996141	18-5797	18-5865	V200	6618751	C100860	18-5798	18-5860 ⑤
75 4 cil	6432901	& Sup	—	18-5859	V200	C100861	D081999	18-5798	18-5860 ③
75 3 cil modelo eléctrico	G438000	& Sup	—	18-5870	V200	C100861	C291519	18-5798	— †
80 (80, 800) 4 cil	4831999	6432900	—	18-5859	V200	C100861	C291519	18-5798	18-5867 ③⑥
80 JET	G438000	& Sup	—	18-5870 **	V200	D082000	G960499	18-5798	18-5876
85 (850) 4 cil	4366802	4831998	—	18-5859	V200 EFI	C100861	OD081999	18-5798	—
90 6 cil	5299506	& Sup	18-5798	18-5854	V200 EFI	G303046	G960499	18-5798	18-5876
90 3 cil modelo eléctrico	G438000	& Sup	—	18-5870	V200 XRI EFI	C291520	D081999	18-5798	— †
90 3 cil (Belgica) modelo eléctrico	9927000	& Sup	—	18-5870	V200 XRI EFI	D082000	G960499	18-5798	18-5876
100 4 cil	G438000	& Sup	—	18-5870 **	V220	B117316	& Sup	—	18-5860
100 4 cil	9927000	& Sup	—	18-5870 **	V225	5628028	& Sup	18-5798	18-5857
100 4 cil con regulador de voltaje.	B209468	G437999	—	18-5873 **	SPORTJET MODELOS				
100 4 cil con reg. de volt. (Bélgica)	9523024	9926999	—	18-5873 **	90	ALL W/RED STATOR	—	—	18-5870
105 JET	D082000	G960499	18-5798	18-5876	95XR	ALL W/RED STATOR	—	—	18-5870
115 6 cil	5314656	& Sup	18-5798	18-5854	120XR	ALL W/RED STATOR	—	—	18-5870
115 4 cil modelo eléctrico	G438000	& Sup	—	18-5870 **	175XR2	ALL	18-5796	—	—
115 4 cil modelo eléctrico (Bélgica)	9927000	& Sup	—	18-5870 **					
115 4 cil con regulador de voltaje.	C10000	G437999	—	18-5873 **					
115 4 cil con reg. de volt. (Bélgica)	9559771	9926999	—	18-5873 **					

① Sólo modelos de arranque eléctrico

② Sólo stators de 5/8".

③ Para regulador de voltaje 16A y tapa de volante sin ventilación

④ Para uso sin regulador de voltaje

⑤ Stators con 5/8" con 15 amp de regulador de voltaje

** Puede requerir la compra de regulador de voltaje si no está actualmente equipado

† Aplicaciones con starter de 40 amp.

18-5741
REGULADOR DE VOLTAJE
 Reemplaza: 815279A2, 815279-1
 Para: Motores mercury con modelos de cargador 16 amp o 40 amp años 1989-91

18-5743
REGULADOR DE VOLTAJE
 Reemplaza: 815279-3, 815279-5, 883072T
 Para: Motores mercury con modelos de cargador 16 amp o 40 amp años 1992 y siguientes
 *Nota: Cable negro va a tierra

18-5732
REGULADOR DE VOLTAJE
 Reemplaza: 893640T01
 Para: 30/40/50/60 EFI 4 Tiempos

18-5707
RECTIFICADOR
 Reemplaza: 62351A1, 62351A2, 816770, 816770T
 Todas las aplicaciones cuadradas

18-5802D Display Package
18-5802
SOLENOIDE
 Reemplaza: 65057A1, 65057T1, 65057, 54981

18-5808D Display Package
18-5808
SOLENOIDE
 Reemplaza: 47886, 47886T

18-5810D Display Package
18-5810
SOLENOIDE
 Aplicación horizontal

18-5811
SOLENOIDE
 Reemplaza: 809463A1, 8094631, 809463, 8094621, 809462
 Para: PG260 Series Starters, (Verado 200-275 HP), (75/95 1.5L DFI), (115/135/150/175/200 2.5L DFI), (225 3.0L DFI)

18-5815D Display Package
18-5815
SOLENOIDE
 Reemplaza: 89-68258A4, 89-853654A1, 89-76545, 89-76545T, 89-65258, 89-61053, 89-15857

18-5816D Display Package
18-5816
SOLENOIDE
 Reemplaza: 89-96054, 89-96054T, 89-91975
 Soporte plano

18-5817D Display Package
18-5817
SOLENOIDE
 Reemplaza: 89-96158, 89-96158T, 94318, 846070
 Aplicación vertical

18-5818D Display Package
18-5818
SOLENOIDE
 Reemplaza: 89-818864, 89-818864T

18-5819D Display Package
18-5819
SOLENOIDE
 Reemplaza: 89-818997A1, 89-818997T1, 89-818997A2

18-5820D Display Package
18-5820
SOLENOIDE
 Reemplaza: 89-818999A2, 89-825842A1, 89-850188T1

18-5821D Display Package
18-5821
SOLENOIDE
 Reemplaza: 89-825096T, 825096T01
 Para: 9.9 4-tiempos(1999 & Sup.), 15 4-tiempos (1999 & Sup), 30 4-tiempos (2002 & Sup.), 40/50/60 4-tiempos(2001 & Sup), 75/90 4-tiempos(2000 & Sup.)

18-5822D Display Package
18-5822
SOLENOIDE ARRANQUE
 Reemplaza: 54293A13, 54393A10, 54393A4
 Para: 75 4cil (1984 & Sup), V150 (1978 & Sup), V150 Magnum (1978-85), V150 Marathon (1978-85), V150 XR 2 (1978-85), V1500 (1978-85), V175 (1976-99), V1750 (1976-88), V200 (1978 & Sup), V2000 (1978-88)

APLICACIÓN EN LA SIGUIENTE PÁGINA

① Referencias acabadas en D envasadas



18-5834
SOLENOIDE
Reemplaza: 89-817109A2
Para: 75 HP (3 cil.) S/N G127500 & Sup



18-5836
SOLENOIDE
Reemplaza: 25661, 256611, 25661T1



18-5729
RELE POWER TRIM
Reemplaza: 87-18211
Para: 35 (2 cil.) (con Ram Trim)
OC159200 & sup
60 (3 cil.) (con Ram Trim)
OB122920 - OD000749



18-5737
RELE POWER TRIM
Reemplaza: 87-19761
Para: 40 (4 cil.) (con Relés)
OC159200 & sup



18-5849
RELÉ, TAPA, TRIM
Reemplaza: 882751A1,
828151A1, 828151, 882751A2
Para: Power Trim Relé usado en la mayoría
Motores 2T y 4T (no-Verado®).



18-5850
RELÉ, TAPA
Reemplaza: 882751A04
Para: 135hp. - 350hp Verado (2005 -
Actual); 496Mag & 496HO (2004 - Actual);
8.1HO (2004 - Actual)



18-5851
RELÉ, TAPA
Reemplaza: 865202T,
807057T, 807057



18-5852
RELÉ, TAPA
Reemplaza: 821509T01, 821509,
853292
Para: 4- tiempos: 45hp
(0G231123-0G472132); 50hp.
(0G231123-0T178499)

① Referencias acabadas en D envasadas

APLICACIÓN SOLENOIDES

HP	DESDE	HASTA	Starter Solenoide/Relé	Power Trim Relé
4-TIEMPOS				
9.9 (4-tiempos)(323cc)	0G760300	0T979999	18-5821	—
15 (4-tiempos)(323cc)	0G760300	1B727495	18-5821	—
30 (4-tiempos) Carb	0G760300	& Sup	—	18-5849
30 (4-tiempos) EFI	0T409000	1B226999	18-5821	18-5849
40 (4-tiempos)(3 cil) Carb	0G760300	& Sup	—	18-5849
40 (4-tiempos)(3 cil) EFI	0T409000	& Sup	18-5821	18-5849
40 (4-tiempos)(4 cil) Carb	0T228405	0T598999	18-5821	18-5849
40 (4-tiempos)(4 cil) EFI	0T409000	& Sup	18-5821	18-5849
45 (4-tiempos) Bodensee	0G231123	0G472132	18-5821	18-5852
45 (4-tiempos) Bodensee	0G472133	0T178499	18-5821	18-5849
50 (4-tiempos)	0G231123	0T178499	18-5821	18-5852
50 (4-tiempos)(4 cil) Carb 996cc	0T178500	0T598999	18-5821	18-5849
50 (4-tiempos)(4 cil) EFI 996cc	0T409000	& Sup	18-5821	18-5849
60 (4-tiempos)(4 cil) Carb 996cc	0T178500	0T598999	18-5821	18-5849
60 (4-tiempos)(4 cil) EFI 996cc	0T409000	& Sup	18-5821	18-5849
75 (4-tiempos) Carb 1596cc	0G960500	1B226999	18-5821	—
75 (4-tiempos) EFI 1596cc	1B366823	& Sup	18-5834	—
90 (4-tiempos) Carb 1596cc	0G960500	1B226999	18-5821	—
90 (4-tiempos) EFI 1731cc	1B366823	& Sup	18-5821	—
115 (4-tiempos) EFI w/ 2 relé trim	0T178500	0T800999	—	18-5849
115 (4-tiempos) EFI 1731cc	0T809000	1B366822	—	18-5849
115 (4-tiempos) EFI 1731cc	1B366823	& Sup	18-5821	—
135 (4-tiempos) Verado	1B227000	& Sup	18-5850	18-5850
150 (4-tiempos) Verado	1B227000	& Sup	18-5850	18-5850
175 (4-tiempos) Verado	1B227000	& Sup	18-5850	18-5850
200 (4-tiempos)(4 cil) Verado	1B517159	& Sup	18-5850	18-5850
200 (4-tiempos)(6 cil) Verado	0T980000	& Sup	18-5850	18-5850
225 (4-tiempos)(6 cil) Verado	0T980000	& Sup	18-5850	18-5850
250 (4-tiempos)(6 cil) Verado	0T980000	& Sup	18-5850	18-5850
275 (4-tiempos)(6 cil) Verado	0T980000	& Sup	18-5850	18-5850
300 (4-tiempos)(6 cil) Verado	1B517434	& Sup	18-5850	18-5850
350 (4-tiempos)(6 cil) Verado	1B716557	& Sup	18-5850	18-5850

HP	Desde	Hasta	Starter Solenoide	Power Trim Solenoide	Power Trim Relé
2-Tiempos					
6/8/9.9	A197112	OD280999	18-5816	—	—
15	A197112	OD280999	18-5816	—	—
18	5837437	& Sup	18-5816	—	—
20	4709593	6443972	18-5815	—	—
20	6443973	0G044026	18-5816	—	—
25	5705532	G044026	18-5816	—	—
30 (2 cil) 644cc	G053314	& Sup	—	—	18-5849
30 JET non-handle	C159200	G589999	18-5816	—	—
35 2 cil (w/ 3 Ram Trim)	6445653	C159199	18-5817	18-5817	—

① Use 18-5817 para aplicaciones con interruptor fusible
 ② Para unidades con terminales 8-32, 114-20.
 ③ Para unidades con terminales 10-32, 516-18.
 ④ Use 18-5818 se necesita solenoide blanco
 ⑤ Para aplicaciones diseño II use 18-5820.
 ⑥ Solenoide con casquillo de goma

APLICACIÓN SOLENOINDE

HP	DESDE	HASTA	Starter Solenoide	Solenoide Power trim	Relé Power trim
35 2 cil (w/ 1 Ram Trim)	C159200	& Sup	18-5817	—	18-5729
40 2 cil	2874704	5556229	18-5836	—	—
40 2 cil	5556230	5823917	18-5815	—	—
40 2 cil	5823918	G053313	18-5817	—	—
40	G053314	& Sup	18-5816 ⑤	—	—
40 4 Cil. (solenoide)	C159200	& Sup	18-5816	18-5820	—
40 4 Cil. (con/relés)	C159200	& Sup	18-5816	—	18-5737
45 4 Cil. (disyuntor)	5531630	6146848	18-5815	18-5815	—
45 4 Cil. (disyuntor)	5531630	6146848	18-5815	18-5817	—
45 4 Cil. (disyuntor)	6146849	B110788	18-5817	18-5815 ①	—
45 4 Cil. (disyuntor)	6146849	B110788	18-5817	18-5817	—
45 4 Cil.	B110789	& Sup	18-5817	18-5817	—
45 JET (solenoide)	D000750	G290584	18-5816	—	—
45 JET	G290585	G589999	18-5820	—	—
50	3008819	4140999	18-5836	—	—
50	4141000	5531629	18-5815	—	—
50 4 Cil. (Disyuntor)	5531630	6146848	18-5815	18-5815 ①	—
50 4 Cil. (Disyuntor)	5531630	6146848	18-5815	18-5817	—
50 4 Cil. (Disyuntor)	6146849	& Sup	18-5817	18-5815 ①	—
50 4 Cil. (Disyuntor)	6146849	& Sup	18-5817	18-5817	—
50 3 Cil.	6428681	B122929	18-5816	18-5817	—
50 3 Cil. (con/ 3 Ram Trim)	B122930	C160935	18-5817	18-5817	—
50 3 Cil. (con/ 1 Ram Trim)	B122930	D000749	18-5817	—	18-5729
50 3 Cil.	D000750	G290584	18-5816	—	18-5849
50 3 cil	G290585	G589999	18-5820	—	18-5849
50 3 cil	G590000	& Sup	—	—	18-5849
55 3 Cil.	D000750	G290584	18-5816 ⑤	—	18-5849
55 3 Cil.	G290585	G589999	18-5820	—	18-5849
60 3 Cil.	6428681	B122929	18-5816	18-5817	—
60 3 Cil. (solenoide)	B122930	D000749	18-5817	18-5817	—
60 3 Cil. (con/relés)	B122930	D000749	18-5817	—	18-5729
60 3 Cil.	D000750	G290584	18-5816 ⑤	—	18-5849
60 3 Cil.	G290585	G589999	18-5820	—	18-5849
65 4 Cil.	2446775	3293183	18-5836	—	—
65 3 Cil.	3547987	4571651	18-5815	—	—
65 JET	G127500	& Sup	18-5834	—	—
70 3 Cil.	4571652	5579016	18-5815	—	—
70 3 Cil.	5579017	6104369	18-5815	18-5815 ①	—
70 3 Cil.	6104370	6428680	18-5816	18-5815 ①	—
70 3 Cil.	A996147	& Sup	18-5817	18-5817	—
75 4 Cil.	6432901	& Sup	18-5816	18-5817	—
75 3 cil w/ 1 Ram Trim	C222000	D252460	—	—	18-5849
75 3 Cil.	D252461	G127499	18-5817	18-5819	—
75 3 Cil.	G127500	G360002	18-5834	18-5819	—
75 3 Cil.	G360003	& Sup	18-5834	—	18-5849
75 Optimax 3 cil (1.5L)	T801000	& Sup	18-5834	—	18-5849
80	2559001	3493912	18-5836	—	—
80 4 Cil.	4831999	5582561	18-5815	—	—
80 4 Cil.	5582562	6030903	18-5815	18-5815 ①	—
80 4 Cil.	6030904	6432900	18-5816	18-5815 ①	—
80 3 Cil.	A996142	& Sup	18-5817	18-5817	—
80 JET 4 cil	D283222	& Sup	18-5834	—	—
80 JET 3 cil	B586067	& Sup	18-5834	—	18-5849
85 4 Cil.	3493913	3865694	18-5836	—	—
85 4 Cil.	3865695	4831998	18-5815	—	—
90	4845301	5299505	18-5815	18-5815	—
90	5299506	6026608	18-5815	18-5815 ①	—
90	6026609	6436122	18-5816	18-5815 ①	—
90	6436123	& Sup	18-5816	18-5817	—
90 3 Cil.	A996142	C221999	18-5817	18-5817	—
90 3 Cil. w/ 1 Ram Trim	C222000	D252460	—	—	18-5849
90 3 Cil.	D252461	G127499	—	18-5819	—
90 3 Cil.	G127500	G360002	18-5834	18-5819	—
90 3 Cil.	G360003	& Sup	18-5834	—	18-5849
90 Optimax 3 cil (1.5L)	T801000	& Sup	18-5834	—	18-5849
100 6 Cil.	2318586	3253111	18-5836	—	—
100 4 Cil. w/ 1 Ram Trim & 5/16-18 terminal	B209468	D252460	18-5834	—	18-5849
100 4 Cil. w/ 3 Ram Trim & 5/16-18 terminal	B209468	D252460	18-5834	—	—
100 4 Cil.	D252461	G359967	18-5834	18-5819	—
100 4 Cil.	G359968	& Sup	18-5834	—	18-5849
105 JET solenoide	D082000	G303045	18-5815	—	—
105 JET solenoide de goma	D082000	G303045	18-5834	—	—
105 JET	G303046	& Sup	18-5834	—	—
110 6Cil.	1870204	2314955	18-5836	—	—
115	2836019	4112634	18-5836	18-5836	—
115	4112635	5600966	18-5815	18-5815	—
115	5600967	6051525	18-5815	18-5815 ①	—
115	6051526	6436122	18-5816	18-5817 ①	—
115	6436123	& Sup	18-5816	18-5817	—
115 4 Cil. w/ 3 Ram Trim & 5/16-18 starter terminal	C100000	D252460	18-5834	—	—
115 4 Cil. w/ 1 Ram Trim & 5/16-18 starter terminal	C100000	D252460	18-5834	—	18-5849
115 4 Cil.	D252461	G359967	18-5834	18-5819	—
115 4 Cil.	G359968	& Sup	18-5834	—	18-5849
115 Optimax 3 cil (1.5L)	T801000	& Sup	18-5834	—	18-5849

① Use 18-5817 para aplicaciones con interruptor y fusible.

③ Para unidades con terminales 10-32, 5/16-18.

⑤ Para aplicaciones diseño II use 18-5820.

② Para unidades con terminales 8-32, 1/4-20.

④ Use 18-5818 si necesita solenoide blanco.

⑥ Solenoide con casquillo de goma

SOLENOIDE APLICACIÓN

HP	DESDE	HASTA	Starter Solenoide	Power Trim Solenoide	Power Trim Relé
115 Pro XS	B751825	& Sup	18-5834	—	18-5849
125	2314956	3253111	18-5836	—	—
125 4 Cil.	D283222	G359967	18-5834	18-5819	—
125 4 Cil.	G359968	& Sup	18-5834	—	18-5849
125 Optimax 3 cil (1.5L)	B736885	& Sup	18-5834	—	18-5849
135	2839369	3293233	18-5836	—	—
V135	A904646	C100860	18-5815 ③	18-5817	—
V135	A904646	C100860	18-5816 ②	18-5817	—
V135	C100861	C239552	18-5815	18-5817	—
V135	C239553	D081999	18-5815 ④	18-5817	—
V135 (con solenoide montado)	D082000	G201874	18-5815	18-5819	—
V135 (con solenoide cojinete goma)	D082000	G201874	18-5834	18-5819	—
V135 (con solenoide montado)	G201875	G303045	18-5815	—	18-5849
V135 (con solenoide cojinete goma)	G201875	G303045	18-5834	—	18-5849
V135	G303046	& Sup	18-5834	—	18-5849
V135 DFI	G590000	& Sup	18-5834	—	18-5849
140	3293234	3502805	18-5836	18-5836	—
140	4865678	& Sup	18-5815	18-5815	—
140 JET	G303046	T178499	18-5834	—	18-5849
150	3502806	4121434	18-5836	18-5836	—
150	4121435	4865677	18-5815	18-5836	—
150 XS	4868648	5327662	18-5815	18-5815	—
V150	4868998	6042945	18-5815	18-5817	—
V150	6042946	A904645	18-5816	18-5817	—
V150	A904646	C100860	18-5815 ③	18-5817	—
V150	A904646	C100860	18-5817 ②	18-5817	—
V150	C100861	C239552	18-5815	18-5817	—
V150	C239553	D081999	18-5815 ④	18-5817	—
V150, 150 EFI (con solenoide montado)	D082000	G201874	18-5815	18-5819	—
V150, 150EF (con solenoide cojinete goma)	D082000	G201874	18-5834	18-5819	—
V150, 150 EFI (con solenoide montado)	G201875	G303045	18-5815	—	18-5849
V150, 150EF (con solenoide cojinete goma)	G201875	G303045	18-5834	—	18-5849
V150, 150 EFI	G303046	& Sup	18-5834	—	18-5849
V150 DFI	G590000	& Sup	18-5834	—	18-5849
150 XR-4/Magnum II	B242885	C239552	18-5815	18-5817	—
150 XR-4/Magnum II (solenoide standard color)	C239553	D081999	18-5815	18-5817	—
150 XR-4/Magnum II (solenoide blanco off)	C239553	D081999	18-5815	18-5818 ⑥	—
150 XR-6/Magnum III (con solenoide montado)	D082000	G201874	18-5815	18-5819	—
150 XR-6/Magnum III (con solenoide montado goma)	D082000	G201874	18-5834	18-5819	—
150 XR-6/Magnum III	G201875	G303045	18-5815	—	—
150 XR-6/Magnum III (con solenoide montado)	G201875	G303045	18-5815	—	18-5849
150 XR-6/Magnum III (con solenoide montado goma)	G201875	G303045	18-5834	—	18-5849
150 XR-6/Magnum III	G303046	& Sup	18-5834	—	18-5849
V175	4301235	6618750	18-5815	18-5815	—
V175	6618751	C239552	18-5816 ②	18-5817	—
V175	6618751	C239552	18-5815 ③	18-5817	—
V175	C100861	C239552	18-5815	18-5817	—
V175	C239553	D081999	18-5815 ④	18-5817	—
V175, 175 EFI (con solenoide montado)	D082000	G201874	18-5815	18-5819	—
V175, 175 EFI (con solenoide montado goma)	D082000	G201874	18-5834	18-5819	—
V175, 175 EFI (con solenoide montado)	G201875	G303045	18-5815	—	18-5849
V175, 175 EFI (con solenoide montado goma)	G201875	G303045	18-5834	—	18-5849
V175, 175 EFI	G303046	& Sup	18-5834	—	18-5849
V175 DFI	G590000	& Sup	18-5834	—	18-5849
V175 Pro XS	B516339	& Sup	18-5834	—	18-5849
V200	4839034	6073191	18-5815	18-5815	—
V200	6073192	6225220	18-5816	18-5817	—
V200	6625221	C100860	18-5816 ②	18-5817	—
V200	6625221	C100860	18-5815 ③	18-5817	—
V200	C100861	C291519	18-5815	18-5817	—
V200 (2.5L)	C291520	D081999	18-5815 ④	18-5817	—
V200 (con solenoide montado)	D082000	G201874	18-5815	18-5819	—
V200 (con solenoide montado)	D082000	G201874	18-5834	18-5819	—
V200, 200 EFI (con solenoide montado)	D082000	G201874	18-5815	18-5819	—
V200, 200 EFI (con solenoide cojinete goma)	D082000	G201874	18-5834	18-5819	—
V200, 200 EFI (con solenoide montado)	G201875	G303045	18-5815	—	18-5849
V200, 200 EFI (con solenoide cojinete goma)	G201875	G303045	18-5834	—	18-5849
V200, 200 EFI	G303046	& Sup	18-5834	—	18-5849
V200 DFI	G386496	& Sup	18-5834	—	18-5849
V220 (Laser)	B117316	& Sup	18-5815	18-5817	—
V225 2.4L	5628028	& Sup	18-5815	18-5815	—
V225 3.0L	D280813	G129221	18-5834	18-5819	—
V225 3.0L	G129222	G303045	18-5834	18-5819	—
V225 3.0L	G129222	G303045	18-5834	—	18-5849
V225 3.0L	G303046	& Sup	18-5834	—	18-5849
V225 DFI	G590000	& Sup	18-5834	—	18-5849
V225 Sea Pro / Marathon	G245605	& Sup	18-5834	—	18-5849
V225 Pro XS	B104549	& Sup	18-5834	—	18-5849
V225/250 EFI	G129222	& Sup	18-5834	—	18-5849
V250XB	G980600	& Sup	18-5834	—	18-5849
V250 Pro XS	B426561	& Sup	18-5834	—	18-5849
V250/275 (3.4L)	C101891	& Sup	18-5815	18-5817	—
300 (3.4L)	5611648	& Sup	18-5815	18-5817	—

① Use 18-5817 para aplicaciones con interruptor y fusible.

③ Para unidades con terminales 10-32, 5/16-18

⑤ Para aplicaciones de diseño II 18-5820.

② Para unidades con terminales 8-32, 1/4-20.

④ Use 18-5818 if off white solenoid is needed.

⑥ Solenoide con casquillo de goma.



18-5929
ALTERNADOR
Reemplaza: 892940T
Todos Verado



18-6454
ALTERNADOR
Reemplaza: 875285T1,
881248T02, 889955T01
5S/ 50 amp montaje bobina
Para: 2.5L



18-6455
ALTERNADOR
Reemplaza: 875286T,
875286A1, 881247A1
5S/ 50 amp
Para: 1.5L y 3.0L
Para: 200 DFI, 200 DFI/DTS, 225 EFI, 225 EFI, Sea Pro, 225 DFI/DTS, 250 EFI



18-6840
ALTERNADOR
Reemplaza: 50-897755T, 897755T
Para: 75-115HP EFI (4-Tiempos)



18-18000
CORREAS
Reemplaza: 57-892318
Para: 75 DFI (2005-06),
90 DFI (2005-06), 15 DFI (2004-06)

18-18100
CORREAS
Reemplaza: 57-828507Q4
Para: 135 DFI (1998-Sup),
150 DFI (1998-Sup), 175 DFI (2001-Sup)



18-15128
CORREAS
Reemplaza: 57-880566014
Para: Todos verados-135-275HP

18-15129
CORREAS
Reemplaza: 57-828507 1
Para: 200 DFI (1997& Sup), 225 DFI (1998 & Sup)



18-6816
MOTOR TRIM
Reemplaza: 172588, 173944
Para: 40, 50, 70, y 75HP con eje corto.



18-6500
CABLEADO ALTERNADOR
Reemplaza: 84-881262A2
Para: Optimax (1998-01) Para: Alternadores Delco

TODOS LOS MOTORES DE ARRANQUE SON ROTACIÓN GIRO DERECHAS



18-5609
MOTOR DE ARRANQUE
Reemplaza: 50-86976
Para: V200 (1978 & Sup), V-2000 (1978-88), V225 (1980-81)



18-6435
MOTOR DE ARRANQUE
Reemplaza: 50-888161T,
50-884044T, 50-859377T, 50-893888T
Para: 40,50,60 HP 4 Tiempos 4 Cil, 0P094500 & sup:
50,60 HP EFI 4 Tiempos 4 Cil, 0P153500-Sup



MOTOR DE ARRANQUE
 Reemplaza: 50-859171T, 50-834749, 50-898265001
 Para: 40HP Italy 4 tiempos 0G760300-Sup: 45HP Bodensee 0G760300-Sup: 50HP 4 tiempos 0G760300-Sup: 50HP Bigfoot 4 tiempos 0G760300-Sup



18-6437
MOTOR DE ARRANQUE
 Reemplaza: 50-888151T, 50-830308T, 50-859169T, 50-893886T
 Para: 25HP 4 tiempos 0G760300 & sup



18-6438
MOTOR DE ARRANQUE
 Reemplaza: 50-888160T, 50-884045T, 50-859170T, 50-854636T, 50-893887T
 Para: 30,40HP 3 Cil 4 tiempos 0G760300 & Sup



18-6425
MOTOR DE ARRANQUE
 Reemplaza: 50-804312T1
 Para: 4 tiempos 75 HP, y 90HP excepto Verado



18-6440
MOTOR DE ARRANQUE
 Reemplaza: 50-892339T, 50-853329T
 Para: 90,V135,V150,V175,V200,2.5L DFI, 0T178500 & sup: 200,250HP,3.0L, 0T467442 & Sup, y en línea 4 y 6 cil. Verados. Modelos con solenoide operado bendix.



18-5601
MOTOR DE ARRANQUE
 Reemplaza: 50-55601, 50-55601A2, 50-38890A1
 Para: 35-50 HP



18-5602
MOTOR DE ARRANQUE
 Reemplaza: 50-67341, 50-58788A3, 50-893891T, 50-44369A1
 Para: 35-40 HP, 2 cil. & 50 HP, 4 cil. modelos



18-5642
MOTOR DE ARRANQUE
 Reemplaza: 50-66015, 50-66015T, 50-893891T, 50-44369A1
 Para: 50-90 HP modelos (1976-99), 10 dientes



18-6282
MOTOR DE ARRANQUE
 Reemplaza: 50-8329972, 50-832997003
 Para: Mercury V6 Jet (1996 y sup), 8 dientes



18-6283
MOTOR DE ARRANQUE
 Reemplaza: 50-8331535, 50-898265008
 Para: Mercury 2.5 DFI(1999 y sup), 200HP V6 DFI(1996-99), 225HP V6 DFI(1998 y sup), 3.0L V6(1999 y Sup) 9 dientes
 Use Kit piñones 18-5658



18-5605
MOTOR DE ARRANQUE
 Reemplaza: 50-73521, 50-73521T, 50-898265005
 Para: 40-50 HP



18-5606
MOTOR DE ARRANQUE
 Reemplaza: 50-44369, 50-60315, 50-44369A1
 Para: 50-70 HP (1976-94)



18-5608
MOTOR DE ARRANQUE
Reemplaza: 50-44415, 50-77141, 50-79472, 50-44414, 50-79472 1, 50-893893
Para: 2.5L, 3.4L & 135 Jet modelos



18-5610
MOTOR DE ARRANQUE
Reemplaza: 50-66015T, 50-660151, 50-660153, 50-893892T, 50-893892T
(8 Dientes)
Para: 1.7L, 1.9L & 1.4L (1988-2008)



18-5611
MOTOR DE ARRANQUE
Reemplaza: 50-90983A-1, 50-90983T1, 50-8M0033984
Para: 6-15 HP (1986-96), 18-25 HP (1980-87), 10 dientes



18-5620
MOTOR DE ARRANQUE
Reemplaza: 50-818445-3, 50-818445-2, 50-818445 5, 50-898265009
Para: 2.5L, 3.0L & 225-250 HP (1993-2000)



18-5621
MOTOR DE ARRANQUE
Reemplaza: 50-822462, 50-822462T1, 50-893890T
Para: 30-60 HP



18-5636
MOTOR DE ARRANQUE
Reemplaza: 50-57465A1, 50-57867, 50-64975, 50-72467, 50-58788A3
Longitud: 11 1/2"
Para: 65-175 HP (1973-88)



18-6824
MOTOR DE ARRANQUE FUERABORDA
Reemplaza: 50-60594A, A1, T01
Para: 2.0, 2.4, y 2.5L Racing



18-6825
MOTOR DE ARRANQUE
Reemplaza: 50-86976
(9 dientes)
Para: Motores 200-225HP V6



18-6828
MOTOR DE ARRANQUE
Reemplaza: 50-41583
Para: 35, 35 (2 CiL.), 402, 40 (2 CiL.)



18-6829
MOTOR DE ARRANQUE
Reemplaza: 50-852570, T, 50-857065, 50-859168, T, 859168, T
Para: Mercury, Mariner 9.9-15HP 4-tiempos



18-6864
MOTOR DE ARRANQUE
Reemplaza: 50-819271, 50-820193A1
Para: Mercury 40-50HP

TODOS LOS MOTORES DE ARRANQUE SON ROTACIÓN A DERECHA



18-6940
MOTOR DE ARRANQUE
Reemplaza: 50-825991A2
Para: 9.9HP 4- tiempos



18-6943
MOTOR DE ARRANQUE
Reemplaza: 50-893894
Para: 9.9-15HP

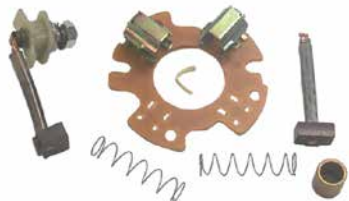

18-6250
KIT REPARACIÓN MOTOR DE ARRANQUE
Prestolite 2 Escobillas



18-6251
KIT REPARACIÓN MOTOR DE ARRANQUE
Prestolite 4 Escobillas



18-5650
PIÑÓN
Reemplaza: 57380
Ver tabla para otras aplicaciones



18-5656
PIÑÓN
Reemplaza: 68575
(10 dientes)
Ver tabla para otras aplicaciones



18-5658
PIÑÓN
Reemplaza: 86177, 86177 1
(9 dientes)
Ver tabla para otras aplicaciones



18-5674
PIÑÓN
Reemplaza: 75661, 13310T1
(8 dientes)
Ver tabla para otras aplicaciones



18-5697
KIT ESCOBILLAS Y MUELLES
Reemplaza: 75384
Ver tabla para otras aplicaciones

MERCURY

H.P.	Desde nº de serie #	Hasta nº de serie #	O.E.M #	Motor de arranque #	O.E. #	Conjunto de Piñones	O.E. #	conjunto de Piñones	Kit Escobillas	O.E. #
6	A197112	& Sup	50-8M0033984/50-90983A1	18-5611	96562		—	10	—	—
7.5	3801458	4851692	50-73531	ⓐ	96562		96562/75427	10	18-5697	75384
7.5	4851693	& Sup	50-78011	ⓐ	96562		96562/75427	10	18-5697	75384
8/9.9/15	A197112	& Sup	50-8M0033984/50-90983A1	18-5611	96562		—	10	—	—
18	5837437	& Sup	50-8M0033984/50-90983A1	18-5611	96562		—	—	—	—
20	4709593	6443973	50-76275	ⓐ	96562		96562/75427	10	—	—
20	6443973	& Sup	50-8M0033984/50-90983A1	18-5611	96562		—	10	—	—
25	5705532	& Sup	50-8M0033984/50-90983A1	18-5611	96562		—	10	—	—
30 2 cil.	G053314	& Sup	50-893890T/50-822462	18-5621	N.L.A.	18-5656	68575	10	18-5697	75384
30 JET	G159200	G589999	50-898265005/50-73521	18-5605	68575 3	18-5656	68575	10	18-5697	75384
30 JET 3 cil.	G590000	T408999	50-893890T/50-822462	18-5621	90643	18-5656	68575	10	18-5697	75384
35 2 cil.	6445653	& Sup	50-41583T/50-41583	ⓐ	N.L.A.		43076/ 43076T	10	18-5697	75384
35/40 2 cil.	6445652	& inf	50-55601A2/50-55601	18-5601	N.L.A.	18-5650	57380	9	18-5697	75384
40 2 cil.	G053314	& Sup	50-893890T/50-822462	18-5621	68575 3	18-5656	68575	10	18-5697	75384
40H.P. 3 cil.	G590000	G760299	50-893890T/50-822462	18-5621	68575 3	18-5656	68575	10	18-5697	75384
40 3 cil.	G760300	& Sup	50-893890T/50-822462	18-5621	68575 3	18-5656	68575	10	18-5697	75384
40 4 cil.	C159200	& Sup	50-898265005/50-73521	18-5605	68575 3	18-5656	68575	10	18-5697	75384
40 JET	T178500	& Sup	50-893890T/50-822462	18-5621	68575 3	18-5656	68575	10	18-5697	75384
45 4 cil.	5531630	& Sup	50-898265005/50-73521	18-5605	68575 3	18-5656	68575	10	18-5697	75384
45 JET	D000750	G589999	50-44369A1/50-65436/50-60315	18-5606 ⓑ	68575 3	18-5656	—	—	—	—
45 JET	G590000	T129554	50-893890T/50-822462	18-5621	68575 3	18-5656	68575	10	18-5697	75384
50 4 cil.	4357639	& abajo	50-55601A2/50-38890A1	18-5601	N.L.A.	18-5650	57380	9	18-5697	75384
50 4 cil.	4357640	& Sup	50-898265005/50-73521	18-5605	68575 3	18-5656	68575	10	18-5697	75384
50 3 cil.	B122930	G589999	50-44369A1	18-5606 ⓑ	68575 3	18-5656	—	—	—	—
50 3 cil.	G590000	& Sup	50-893890T/50-822462	18-5621	68575 3	18-5656	68575	10	18-5697	75384
55 3 cil.	D000750	G589999	50-44369A1	18-5606 ⓑ	68575 3	18-5656	—	—	—	—
55 3 cil.	G590000	& Sup	50-893890T/50-822462	18-5621	68575 3	18-5656	68575	10	18-5697	75384
60 3 cil.	6428681	G589999	50-44369A1/50-65436/50-60315	18-5606 ⓑ	68575 3	18-5656	—	—	—	—
60 3 cil.	G590000	& Sup	50-893890T/50-822462	18-5621	68575 3	18-5656	68575	10	18-5697	75384
60 3 cil. Bigfoot	G590000	G760299	50-893890T/50-822462T 1	18-5621	68575 3	18-5656	68575	10	18-5697	75384

Nota: Algunos starters se adaptan a versiones de prestolite en principio sólo son para versiones Bosh.

- ⓐ 6 Cilindros en línea
- ⓑ Con piñones 8 dientes
- ⓒ Con piñones 9 dientes

ⓓ No hay recambio del starter, sólo piezas

ⓔ Sólo modelos Bosh

ⓕ Algunas aplicaciones requieren adaptador Mercury #44368 (anterior a S/N OD000750)

MERCURY

H.P.	Desde nº de serie #	Hasta nº de serie #	O.E.M #	Motor de arranque #	O.E. #	Conjunto de Piñones	O.E. #	Nº De Dientes	Kit Escobillas	O.E. #
65 4 cil.	2803822	3293183	50-57867A1/50-58788	18-5636	68575 3	18-5656	68575	10	18-5697	75384
65 3 cil.	3293184	4571651	50-44369A1/50-65436/50-60315	18-5606	68575 3	18-5656				
65 Jet	D283222	& Sup	50-893891T/50-66015	18-5642	68575 3	18-5656	68575	10	18-5697	75384
70 3 cil.	457165	A996142	50-44369A1/50-65436/50-60315	18-5606	68575	18-5656				
80 4 cil.	2783253	3493912	50-57867A1/50-58788	18-5636	N.L.A.		68575	10	18-5697	75384
80 4 cil.	4831999	& Sup	50-893891T/50-66015	18-5642	68575 3	18-5656	68575	10	18-5697	75384
85 4 cil.	3865694	& Inferior	50-58788A3/50-58788	18-5636	N.L.A.	18-5656	68575	10	18-5697	75384
85 4 cil.	3865695	4366801	50-67341	18-5602	68575 3	18-5656	68575	10	18-5697	75384
80 Jet	D283222	& Sup	50-893892T/50-66015-1	18-5610	68575 3	18-5656	75660/13310T1	8	18-5697	75384
90	4845301	& Sup	50-72467/50-64975/50-57465A1	18-5636	68575 3	18-5656	68575	10	18-5697	75384
90 3 cil.	A996142	& Sup	50-893891T/50-66015	18-5642	68575 3	18-5656	68575	10	18-5697	75384
100 4 cil.	B209468	G965520	50-893892T/50-66015-1	18-5610	68575-3	18-5674	75660/13310T1	8	18-5697	75384
105 JET	G760299	& Inferior	50-893893/50-44414/50-44415/50-79472/50-77141	18-5608	13310T 1	18-5674	75660/13310T1	8	18-5697	75384
115 6 cil.	4855153	& Sup	50-72467/50-64975/50-57465A1	18-5636	68575 3	18-5656	68575	10	18-5697	75384
115 4 cil.	C100000	& Sup	50-893892T/50-66015-1	18-5610	68575 3	18-5674	75660/13310T1	8	18-5697	7538
125 4 cil.	D283222	& Sup	50-893892T/50-66015-1	18-5610	68575 3	18-5674	75660/13310T1	8	18-5697	75384
135 V-6	A904646	G960499	50-893893/50-79472/50-77141/50-44414/50-44415	18-5608	13310T 1	18-5674	75660/13310T1	8	18-5697	75384
140 6 cil. en línea	4865678	& Sup	50-72467/50-64975/50-57465A1	18-5636	68575 3	18-5656	68575	10	18-5697	75384
140 JET	G960499	& Inferior	50-893893/50-44414/50-44415/50-79472/50-77141	18-5608	1310T 1	18-5674	75660/13310T1	8	18-5697	75384
150	4121435	& Sup	50-72467/50-64975/50-57465A1	18-5636	68575 3	18-5656	68575	10	18-5697	75384
V150	4868998	G960499	50-793793/50-79472/50-77141	18-5608	13310T 1	18-5674	75660/13310T1	8	18-5697	75384
150 XR2	4868998	A904645	50-44414,50-44415	18-5608	N.L.A.	18-5674	75660/13310T1	8	18-5697	75384
150 XR4	B242885	D819999	50-893893/50-79472/50-77141/50-44414/50-44415	18-5608	13310T 1	18-5674	75660/13310T1	8	18-5697	75384
150 XR6	D082000	G960499	50-893893/50-79472/50-77141/50-44414/50-44415	18-5608	13310T 1	18-5674	75660/13310T1	8	18-5697	75384
150 EFI	G303046	T408999	50-893893/50-79472/50-77141/50-44414/50-44415	18-5608	13310T 1	18-5674	75660/13310T1	8	18-5697	75384
V175	4301235	G960499	50-893893/50-79472/50-77141	18-5608	13310T 1	18-5674	75660/13310T1	8	18-5697	75384
175 EFI, XRI, MAG	D000750	G960499	50-893893/50-44414/50-44415	18-5608	N.L.A.	18-5674	75660/13310T1	8	18-5697	75384
200	4839034	G960499	50-893893/50-79472/50-77141	18-5608	13310T 1	18-5674	75660/13310T1	8	18-5697	75384
200 EFI, XRI	C100861	G960499	50-893893/50-44414/50-44415	18-5608	N.L.A.	18-5674	75660/13310T1	8	18-5697	75384
2.4EFI/2.5EFI/	Todos	—	50-893893/50-79472/50-77141/50-44414/50-44415	18-5608	13310T 1	18-5674	75660/13310T1	8	18-5697	75384
2.5 Carb/	Todos	—	50-893893/50-79472/50-77141/50-44414/50-44415	18-5608	13310T 1	18-5674	75660/13310T1	8	18-5697	75384
3.4L/MOD VP	todos	—	50-893893/50-79472/50-77141/50-44414/50-44415	18-5608	13310T 1	18-5674	75660/13310T1	8	18-5697	75384
V200	5363918	6435503	50-86976	18-5609	8677 1	18-5658	86177/86177 1	9	18-5697	75384
V225	5628028	D280812	50-86976	18-5609	8677 1	18-5658	86177/86177 1	9	18-5697	75384
225 3.0L Carb	D280813	T408999	50-898265009/50-818445-3/50-818445-2	18-5620	13310T 1	18-5674	75661/13310T1	8	18-5697	75384
225/250 EFI 3.0L	G129222	& Sup	50-898265009/50-818445-3/50-818445-2	18-5620	13310T 1	18-5674	75661/13310T1	8	18-5697	75384
250XB	G980600	& Sup	50-898265009/50-818445-3/50-818445-2	18-5620	13310T 1	18-5674	75661/13310T1	8	18-5697	75384

Nota: Algunos starters se adaptan a versiones de prestolite en principio sólo son para versiones Bosh.

- ② 6 Cilindros en línea
- ④ Con piñones 8 dientes
- ⑤ Con piñones 9 dientes

- ⑥ No hay recambio del starter, sólo piezas
- ⑦ Sólo modelos Bosh
- ⑧ Algunas aplicaciones requieren adaptador Mercury #44368 (anterior a S/N 0D000750)

**18-7354
KIT CARBURADOR**
Reemplaza:
1395-8506
V-175 Fuerabordas
Número de serie 4301235 hasta OC100860

**18-7355
KIT CARBURADOR**
Reemplaza: 1395-811691 2

**18-7356
KIT CARBURADOR**
Reemplaza: 1395-811691 3

**18-7004
KIT CARBURADOR**
Reemplaza: 1395-6200

**18-7005
KIT CARBURADOR**
Reemplaza: 1395-6452

**18-7006-1
KIT CARBURADOR**
Reemplaza: 1399-1717,
1399-2015, 1399-3523, 1395-4808,
1395-8791994024, 879194024



18-7007
KIT CARBURADOR
Reemplaza: 1399-5135,
1399-5198



18-7013
KIT CARBURADOR
Para: AJ, KA, KB, KC, KD Carburador



18-7021
KIT CARBURADOR
Para: WM, WMK



18-7211-1
KIT CARBURADOR
Reemplaza: 1395-8112231



18-7212
KIT CARBURADOR
Reemplaza: 1395-97611, 1395-9761, 1395-9803,
1395-9725, 1395-9645, 1395-9377, 1395-9179,
1395-811357

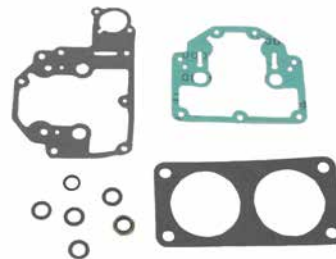

18-7213
KIT CARBURADOR
Reemplaza: 8107492

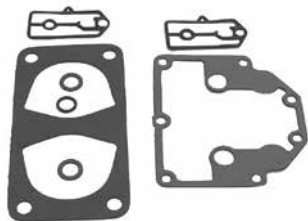

18-7214
KIT CARBURADOR
Reemplaza: 8107493



18-7215
KIT CARBURADOR
Reemplaza: 1395-9024

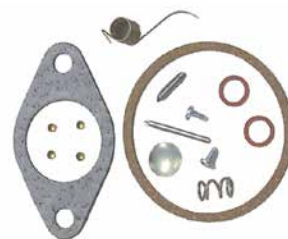

18-7216
KIT CARBURADOR
Reemplaza: 809449A1
Para: 25 HP Force &
25 HP 3 cil Merc. & Sears 1996-98

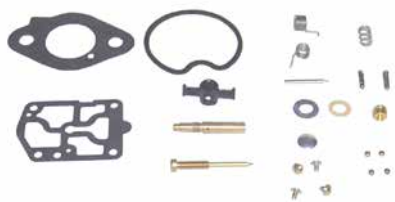

18-7226
KIT CARBURADOR
Reemplaza: 1395-9650
Para: 30 JET, 40/45 4 Cil 4 Tiempos,
Carb modelos WMA-7B,9,10,13



18-7290
KIT CARBURADOR
Reemplaza: 84419M



18-7291
KIT CARBURADOR
Reemplaza: 84475M























18-7293
KIT CARBURADOR
Reemplaza: 92520M



18-7738
KIT CARBURADOR
Reemplaza: 802706A1
Para: 9.9 4 Tiempos (323cc) (1999 & sup)
y 15 4 tiempos (1998 & sup)



18-7743
KIT CARBURADOR
Reemplaza: 804346T1
Para: 75 4 Tiempos (2000 & sup), 90 4 tiempos (2000 & sup)

 <p>18-7750-1 KIT CARBURADOR Reemplaza: 1395-8236354, 1395-8236353, 1395-8236352, 1395-8236351, 1395-823635, 1395-811222, 1395-9599 Para: WME-1,1A,1B,4,5,6,6A,7, 7B,8,9,10,10A,11,14,15,15A,17, 18,20,20A,21,21A,22,22B,23,2, 4,26,27,28,32,32A,33,34,35,36, 36A,37,37A,38,39A,40,40A,42,4 2A,43,44,45,50,52,53,57,58,63, 64,65,66,67,68,69,79,81</p>	 <p>18-7765 KIT CARBURADOR Reemplaza: 11502M</p>	 <p>18-7769 KIT CARBURADOR Reemplaza: 814481M</p>	 <p>18-7770 KIT CARBURADOR Reemplaza: 84456M</p>	 <p>18-34500 CARBURADOR Reemplaza: 3303-895110T01 Para: 9.9 Handle (4-Tiempos) (R042475-R068397)</p>
 <p>18-7062 AGUJA Reemplaza: 1395-95951 Para: WME-1,1A,1B,4,5,6,6A,7, 7B,8,9,10,10A,11,14,15,15A,17, 18,20,20A,21,21A,22,22B,23, 24,26,27,28,32,32A,33,34,35, 36,36A,37,37A,38,39A,40,40A, 42,42A,43,44,45,50,52,53,57, 58,63,64,65,66,67,68,69,79,81</p>	 <p>18-7057 AGUJA Y ASIEN Reemplaza: 1399-1473, 1395-9258, 1399-1138, 1399-9258 1 .078</p>	 <p>18-0715 JUNTA CAMARA Reemplaza: 809086, 25-809086</p>	 <p>18-7061 AGUJA Y ASIEN Reemplaza: 1395-8318, 1395-83181 .065</p>	 <p>18-7295 VÁLVULA DE AGUJA Reemplaza: 1395-9022</p>
 <p>18-7233 AGUJA Y ASIEN Reemplaza: 1395-7824</p>	 <p>18-36850 AGUJA Y ASIEN Reemplaza: 1395-8116901 Para: Mercruiser 2.5 & 3.0L Carbs</p>	 <p>18-7380 FLOTADOR Reemplaza: 809569 15 (4-tiemp.) todos, 50 (4-tiemp.)</p>	 <p>18-7381 FLOTADOR Reemplaza: 16253 4 (SN A855097 & sup), 5 (SN A855097 & sup)</p>	 <p>18-7382 FLOTADOR Reemplaza: 804184 75 (4-tiempos) todos, 90 (4-tiempos) todos</p>
 <p>18-7208 FLOTADOR Reemplaza: 1395-8983, 1395-8673</p>	 <p>18-72000 FLOTADOR Reemplaza: 1395-9594 Para: WME1,1A,1B,4,5,6,6A,7, 7B,8,9,10,10A,11,14,15,15A, 17,18,20,20A,21,21A,22,22B, 23,24,26,27,28,32,32A,33,34, 35,36,36A,37,37A,38,39A,40, 40A,42,42A,43,44,45,50, 52,53,57,58,63,64,65,66,67, 68,69,79,81</p>	 <p>18-7249 KIT FLOTADOR Reemplaza: 19273 Para: WM-3,5,6,8,9,10,11,12,13, 13A,14,15,15A,16,16A,17,18</p>	 <p>18-7209 FLOTADOR Reemplaza: 1395-9293</p>	 <p>18-36956 FLOTADOR Reemplaza: 1395-9267 Para: Mercury V6 con carb. dual</p>

APLICACIÓN KIT CARBURADOR MARINER

HP	Año/N° de serie	Modelo carb.	HP	Año/N° de serie	kit carb.	HP	Año/N° de serie	kit carb.
6 C-D	Ser.No.Code 6H8 & 6H6	18-7765	25A	M-648-24991 & Sup ML-648-64046 & Sup	18-7770	30A	M-689-230100 & Sup ML-689-530100 & Sup	18-7770
8C	Ser.No.Code 6G1	18-7765		E-648-27056 & Sup EL-648-56526- & Sup			E-689-250100 & Sup EL-689-550100 & Sup	
9.9C	M-682-070796 & Sup ML-682-368040 & Sup E-682-251511 & Sup EL-682-55146 & Sup	18-7769	25C	Ser.No.Code 695	18-7770	48	M-670-02641 & Sup ML-670-34581 & Sup	18-7290
15C	M-684-052848 & Sup ML-684-332302 & Sup E-684-252381 & Sup EL-684-553251 & Sup	18-7769	28	M-664-05306 & Sup ML-664-41686 & Sup E-664-26236 & Sup EL-664-57421 & Sup	18-7770	W48	Ser.No.Code 670	18-7290
						55	Ser.No.Code 663	18-7290
						W55	Ser.No.Code 663	18-7290
						60	Ser.No.Code 675	18-7290

APLICACIÓN KIT CARBUADOR MERCURY

HP	Año/N° de serie	Modelo carburador	kit carburador	Kit de juntas	Aguja y asiento	Flotador
3.9	1964-68	KB-7A,KB-7B	18-7013	18-7006-1	18-7057	18-7208
4 (1 cil.)	1969-74, 80-81,86-87	KB-10A	18-7013	18-7006-1	18-7057	18-7208
4 (1 cil.)		WMD-1	—	18-7006-1	18-7061	18-7208
4.5	1980-85	KD-10A	18-7013	18-7006-1	18-7057	18-7208
4.5	1980-85	WMD-1	18-7021	18-7006-1	18-7061	18-7208
6	1961-68	KB-6A,6B,7B,AJ57A	18-7013	18-7006-1	18-7057	18-7208
6	S/N A197112-Sup	WMC-5.5A,5B,7,7A, 17,17B,17C,18,18A, 18B,19,19A,20,20A, 20B,23,28,34, 39,41,47,49	—	—	—	—
			—	—	—	—
			—	—	—	—
			—	—	—	—
			—	—	—	—
7.5	1969-73	KB-9A,KB-12A	18-7013	18-7006-1	18-7057	18-7208

APLICACIONES CONTINÚAN EN LA PÁGINA SIGUIENTE

APLICACIÓN KIT CARBURADOR MERCURY (Cont)

HP	Año/Nº de serie	Modelo carburador	Kit carburador	kit de juntas	Aguja y asiento	Flotador
7.5	1972-85	BB-2A, BB-2B, BB-2C, BB-4A, BB-5A, BB-5B, BB5C, BB-5D, BB-7A, BB-7C	—	—	—	—
7.5		WMB-2, 4	—	18-7007	18-7295	18-7209
8	S/N A197112-Sup	WMC-5,5A,5B,7,7A, 17,17B,17C,18,18A, 18B,19,19A,20,20A, 20B,23,28,34, 39,41,47,49,57	—	—	18-7295	18-7209
9.8	1962-73	KB-5A,8A,11A	18-7212	—	—	—
9.8	1972-85	BB-1B, BB-1C, BB-3A, BB-3B, BB-3C, BB-6A, BB-6C	18-7013	18-7006-1	18-7057	18-7208
9.8		WMB-1, 3	—	—	18-7295	18-7209
9.9 (2 tiempos)	S/N A197112-Sup	WMC-5,5A,5B,7,7A,17,17B, 17C,18,18A,18B,19,19A,20, 20A,20B	—	18-7212	—	—
9.9 (2 tiempos)		WMC-23,28,34,39,41,41A, 47,47A,49,49A,57	—	18-7212	—	—
9.9 (4 tiempos) (4 tiempos) (323cc)	S/N 0G590000-Sup	—	—	—	—	—
10	1957-61	AJ-52A	18-7738	—	—	—
10		AJ-56AB	18-7013	18-7006-1	18-7057	18-7208
10		KB-1A, 4A	—	18-7006-1	18-7057	18-7208
10 Seapro/ Marathon	Todos	WMC-33,33A,40,42, 50,50A,55,55A	—	18-7212	—	—
XR-10	Todos	WMC-23,48,48A,49,49A	—	18-7212	—	—
MAG 10	Todos	WMC-23,48,48A,49,49A	—	18-7212	—	—
15	1959-61	AJ-52A, AJ-56A	18-7013	18-7006-1	18-7057	18-7208
15 (150)		KB-1A, 4A	—	18-7006-1	18-7057	18-7208
15	S/N A197112-Sup	WMC-5,5A,5B,7,7A,17,17B, 17C,18,18A,18B,19,19A,20, 20A,20B	—	18-7212	—	—
15		WMC-23,28,34,39,41,41A, 47,47A,49,49A,57	—	18-7212	—	—
15	S/N 0G590000-Sup	—	18-7738	—	—	—
15 Seapro/ Marathon	Todos	WMC-33,33A,40,42, 50,50A,55,55A	—	18-7212	—	—
Super 15	S/N 6443973-Sup	WMC-1,2,3,4,9,10, 11,12,13,13A,14, 14A,15A,16A,24,25, 26,27,29,30,31,31A, 32,32A,35,35A,35B, 36,37,44,45,46, 46A,50,53,54,56	—	—	18-7212	—
Seapro/ Marathon	S/N 6443973-Sup	WMC-1,2,3,4,9,10, 11,12,13,13A,14, 14A,15A,16A,24,25, 26,27,29,30,31,31A, 32,32A,35,35A,35B, 36,37,44,45,46,46A, 50,53,54,56	—	—	18-7212	—
15 (4-Tiempos)	S/N 0G590000-Sup	—	18-7738	—	—	—
18	S/N 6443973-Sup	WMC-1,2,3,4,9,10, 11,12	—	—	—	—
18		WMC-13,13A,14,14A,15A, 16A,24,25,26,27,29,30,31, 31A	—	18-7212	—	—
20	S/N 6443973-Sup	WMC-1,2,3,4,9,10, 11,12	—	—	18-7212	—
20		WMC-13,13A,14,14A,15A, 16A,24,25,26,27,29,30,31, 31A	—	18-7212	—	—
20 (200)	1963-72	KA-20A,22A,22B,22C,23A,25A	18-7013	18-7006-1	18-7057	18-7208
20	1973-80	BA-1A, BA-2A, BA-2C, BA-2D, BA-2E	—	18-7007	—	18-7209
Jet 20	S/N 6443973-Sup	WMC-1,2,3,4,9,10,11, 12,13,13A,14,14A, 15A,16A,24,25,26, 27,29,30,31,31A,32, 32A,35,35A,35B,36, 37,44,45,46, 46A,50,53,54,56	—	—	—	—
22	1958-59	KA-KC	18-7013	18-7006-1	18-7057	18-7208
25 (2 cil)	S/N 6443973-Sup	WMC-1,2,3,4,9,10, 11,12	—	18-7212	—	—
25 (2 cil)		WMC-13,13A,14,14A,15A, 16A,24,25,26,27,29,30,31, 31A,32,32A,35,35A,35B,36, 37,44,45,46,46A,50,53,54, 56	—	18-7212	—	—
30 (2 cil.)(644cc)	S/N G053314-Sup	WME-36,36A,37,37A, 38,39A,42,42A, 63,64,65,66,67	—	—	—	—
			18-7750-1	18-7211-1	—	18-72000
30 (300) 4-cil		AJ-54A	—	—	18-7057	18-7208
30 (300) 4-cil		KB-2A	—	17-7006-1	18-7057	18-7208
30 JET (3 cil)		WME-53,68,69	18-7750-1	18-7211-1	—	18-72000
30 JET (4 cil)		WMA-10,13	18-7226	—	—	—
35	1984-89	KC-4A,8A,9A,9B, 9C,13A	18-7013	18-7006-1	18-7061	18-7208
35	1963-69	KB-2A	18-7013	18-7006-1	18-7057	18-7208
35	1984-89	WMK-38	18-7021	18-7006-1	18-7061	18-7208

APLICACIONES EN LA SIGUIENTE PÁGINA





















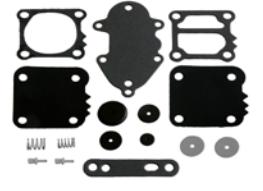

APLICACIÓN KIT CARBURADOR MERCURY (Cont)

HP	Año/Nº de serie	Modelo carburador	Kit carburador	Kit de juntas	Aguja y asiento	Flotador
35		AJ-54A	—	—	18-7057	18-7208
40	1960-61	KA-7A,KD-5A, KA-2A,KA-9A	—	—	—	—
40	1954-59	AJ	18-7013	18-7006-1	18-7057	18-7208
40	1970-74	WMK-1,WMK-8	18-7021	18-7006-1	18-7061	18-7208
40	1975-83	WMK-21,WMK-24, WMK-31	—	—	—	—
40 (2 cil.)	S/N G053314-Sup	WME-36,36A37,37A, 38,39A,42,42A,63, 64,65,66,67	18-7750-1	18-7211-1	—	18-72000
40 (3 cil)		WME-53, 68, 69	18-7750-1	18-7211-1	—	18-72000
40 (4 cil.)		WMA-4	—	18-7215	18-7295	18-7209
40 (4 cil.)		WMA-7B	18-7226	—	—	18-7209
40 (4 cil.)		WMA-9, 10, 13	18-7226	—	—	—
45	1958-62	KA-2A	18-7013	18-7006-1	18-7057	18-7208
45	1958-62	AJ-54A	18-7013	18-7006-1	18-7057	18-7208
45 (4 cil.)	1986	Tillotson/Walbro	—	18-7007	—	18-7209
45 (4 cil.)	1987-Sup	WMA-4	—	18-7215	18-7295	18-7209
45 (4 cil.)		KA-17A	18-7013	—	18-7057	18-7208
45 (4 cil.)		WMA-7B	18-7226	—	—	18-7208
45 (4 cil.)		WMA-9, 10, 13	18-7226	—	—	—
45 JET (3 cil)		WME-57, 58	18-7750-1	18-7211-1	—	18-72000
50 (4 cil.)	1961-75	KA-13A,18A,19A, 21A,21B,21C,21D, 24A,26A,26B,27A	—	—	—	—
50	1976-85	BA-3B,BA-3C,BA-3D	18-7013	18-7006-1	18-7057	18-7208
50 (3 cil.)	1986-90	WM-13, 13A, 15, 15A, 16, 16A, 18	—	18-7004	—	18-7249
50 (3 cil.)		WME-22,22B,23,24,26, 27, 28, 35, 43, 44, 45, 53, 68, 69	18-7750-1	18-7211-1	—	18-72000
50 (4cil)	1986-Sup	WMA-1,3	—	18-7215	18-7295	18-7209
50 (4cil)		BA-3A, 3B, 3C, 3D, 4A	—	18-7007	18-7295	18-7209
50 (4cil)		WMK-8	18-7021	18-7006-1	18-7061	18-7208
55 (3 cil.)		WM-13, 13A, 15, 15A, 16, 16A, 18	18-7249	18-7004	—	—
55		WME-22, 22B, 23, 24, 26, 27, 28, 35, 43, 44, 45, 57, 58	18-7750-1	18-7211-1	—	18-72000
60 (3 cil.)	S/N D000750-Sup	WME-22,22B,23,24,26, 27, 28, 35, 43, 44, 45, 57, 58	18-7750-1	18-7211-1	—	18-72000
60 (3 cil.)	1984-90	WM-13,13A, 15, 15A, 16, 16A, 18	—	18-7004	—	18-7249
60	1957-60	AJ-53A,AJ-55A,KB	18-7013	18-7006-1	18-7057	18-7208
60 600 (6 cil)		KB-3A	—	18-7006-1	18-7057	18-7208
65 650 (4 cil)	1963-71	KC-2A,5A,5B,5C, 11A,15A	18-7013	18-7006-1	18-7057	18-7208
65 650 (3 cil)	1972-75	WMK-5,WMK-12, WMK-13,WMK-20	18-7021	18-7006-1	18-7061	18-7208
65	1976	WM-2,WM-4	—	18-7004	18-7061	18-7208
Jet 65 (3 cil)	S/N A996142-Sup	WME-1,1A,1B,4,5,6,6A, 7, 7B, 8, 9, 10, 10A, 15, 15A, 17, 18, 19, 25, 29, 30, 31, 41, 46, 47, 48, 49, 59, 60, 61, 62, 75, 76, 77	18-7750-1	18-7211-1	—	18-72000
70	1958-62	KC,KA-2A	18-7013	18-7006-1	18-7057	18-7208
70 700 (6 cil)		KA-8A, 12A	18-7013	18-7006-1	18-7057	18-7208
70	1977-83	WM-6,8, 9, 11	—	18-7004	18-7061	18-7249
70 (3 cil.)	S/N A996142-Sup	WME-1,1A,1B,4,5, 6,6A,7,7B,8,9,10, 10A,15,15A,17,18, 19,25,29,30,31,41, 46,47,48,49,59, 60,61,62	—	—	—	—
75 (4 cil.)	1984-86	WM-14, 17	18-7750-1	18-7211-1	—	18-72000
75 (3 cil.)	S/N A996142-Sup	WME-1,1A,1B,4,5, 6,6A,7,7B,8,9,10, 10A,15,15A,17,18, 19,25,29,30,31,41, 46,47,48,49,59, 60,61,62	18-7750-1	18-7211-1	—	18-72000
75 (4 tiempos)	S/N OG960500-Sup	—	18-7743	—	—	—
80 (3 cil.)	S/N A996142-Sup	WME-1,1A,1B,4,5, 6,6A,7,7B,8,9,10, 10A,15,15A,17,18, 19,25,29,30,31,41, 46,47,48,49,59, 60,61,62	18-7750-1	18-7211-1	—	18-72000
80 (4 cil.)	1960-61	KD-4A	18-7013	18-7006-1	18-7061	18-7208
80 (4 cil.)	1969-72	WMK-2	18-7021	18-7006-1	18-7061	18-7208
80 (4 cil.)	1978-83	WM-5,10,12, 14, 17	—	18-7004	18-7061	18-7249
80 800 (6 cil)		KA-10A, 11A, 14A, 16A, KC-3A	—	18-7006-1	18-7057	18-7208
Jet 80 (4 cil.)	S/N B209468-Sup	WME-11,14,20,20A, 21,21A,32,32A,33, 34,40,40A,50,51,52,79	18-7750-1	18-7211-1	—	18-72000
85	1973-75	WMK-4,WMK-16, WMK-17	18-7021	18-7006-1	18-7061	18-7208
85 850 (6 cil)	1963-65	KA,KC	18-7013	18-7006-1	18-7057	18-7208
85	1976-77	WM-3,WM-5	—	18-7004	18-7061	18-7249
90 (3 cil.)	S/N A996142-Sup	WME-1,1A,1B,4,5,6, 6A,7,7B,8,9,10,10A, 15,15A,17,18,19,25, 29,30,31,41,46,47, 48,49,59,60,61,62	—	—	—	—
90 (4 tiempos)	S/N OG960500-Sup	—	18-7743	—	—	—
90 (6 cil.)	1965	KC-6A	18-7013	18-7006-1	18-7057	18-7208
90 (6 cil.)	1978-86	WMK-23,WMK-27, WMK-30,WMK-35, WMK-39	—	—	—	—
95	1966-67	KC-6A	18-7021	18-7006-1	18-7061	18-7208
100 (4 cil.)	S/N B209468-Sup	WME-11,14,20,20A, 21,21A,32,32A,33,34,	—	—	—	—

APLICACIONES CONTINUAN EN LA SIGUIENTE PÁGINA

APLICACIÓN KIT CARBURADOR MERCURY (Cont.)

HP	Año/N° de serie	Modelo Carburador	kit carburador	Kit de juntas	Aguja y asiento	Flotador
100 (6 cil.)	1962-69	40,40A,50,51,52,79	18-7750-1	18-7211-1	—	18-72000
100 (6 cil.)		KC-1A,7A,10A,14A	18-7013	18-7006-1	18-7057	18-7208
V-105 Jet	1994-95 S/N OD082000-OG303045	KD-1A, 1B, 2A, 3A	18-7013	18-7006-1	18-7061	18-7208
V-105 Jet	1996 & Sup S/N OG303046 & Sup	WMH-13, 13B, 23, 31	18-7355	18-7213	—	—
110		WMV-2, 2A	18-7356	18-7214	—	—
115 (4 cil.)	S/N B209468-Sup	KC-1A, 7A, 7B, 10A, 14A	18-7013	18-7006-1	18-7057	18-7208
		WME-11,14,20,20A,	—	—	—	—
		21,21A,32,32A,33,34,	—	—	—	—
		40,40A,50,51,52	18-7750-1	18-7211-1	—	18-72000
115 (6 cil.)	1970-77	KD-6A,KD-6B	18-7013	18-7006-1	18-7061	18-7208
115 (6 cil.)	1970-88	WMK-3,10,15, 18, 26, 28, 32, 36 , 40, 41, 41-1A, 41-1B, 41-3A, 41-3B	18-7021	18-7006-1	18-7061	18-7208
125	1968-69	KD-1A,1B,2A, 3A	18-7013	18-7006-1	18-7057	18-7208
125 (4 cil.)	S/N B209468-Sup	WME-11,14,20,20A,	—	—	—	—
		21,21A,32,32A,33,	—	—	—	—
		34,40,40A,50,51,52, 81	18-7750-1	18-7211-1	—	18-72000
135	1970-71	KD-7A,KD-7B	18-7013	18-7006-1	18-7057	18-7208
135	1970-71	WMK-4	18-7021	18-7006-1	18-7061	18-7208
V-135	1986-88 S/N OA904646-OC100860	WH-33, 40	18-7354	18-7005	18-7233	—
V-135	1986-88 S/N OA904646-OC100860	WH-32, 35, 38	18-7354	18-7005	—	—
V-135	1989-90 S/N OC100861-OC239552	WH-35, 38	—	18-7005	18-7233	—
V-135	1989-90 S/N OC100861-OC239552	WH-40, 48	18-7354	18-7005	18-7233	—
V-135	1991 S/N OC239553-OD081999	WMH-8, 8A	18-7355	18-7213	—	—
V-135	1992-95 S/N OD082000-OG303045	WMH-12A, 12B, 28, 30	18-7355	18-7213	—	—
V-135	1996-98 S/N OG303046-OG760299	WMV-1, 1A	18-7356	18-7214	—	—
V-135	1999 & Sup S/N OG760300 & Sup	WMV-1A, 15, 15A	18-7356	18-7214	—	—
140	1972	WMK-7,WMK-9	18-7021	18-7006-1	18-7061	18-7208
140	1978-80	WMK-25,WMK-29	18-7021	18-7006-1	18-7061	18-7208
V-140 Jet	1994-95 S/N OG082000-OG303045	WMH-16, 21, 34, 39	18-7355	18-7213	—	—
V-140 Jet	1996-98 S/N OG303046-OG760299	WMV-5, 5A	18-7356	18-7214	—	—
V-140 Jet	1999 & Sup S/N OG760300 & Sup	WMV-5A	18-7356	18-7214	—	—
150	1973-77	WMK-11	18-7021	18-7006-1	18-7061	18-7208
150	1973-78	WMK-14,WMK-19,	—	—	—	—
		WMK-22	18-7021	18-7006-1	18-7061	18-7208
3.4L	1984-86	WO-3	—	—	18-7233	—
V150	1978-90	WH-2,12,21,23,27, 29,35,38,40,48	—	—	—	—
V-150	1979-85 S/N OA904645 & inferior	WH-9	—	18-7005	—	—
V-150	1979-85 S/N OA904645 & inferior	WH-12	—	18-7005	18-7233	—
V-150	1979-85 S/N OA904645 & inferior	WH-29	18-7354	18-7005	18-7233	—
V-150	1986-90 S/N OA904646-OC239552	WH-35, 38	—	18-7005	18-7233	—
V-150	1986-90 S/N OA904646-OC239552	WH-40, 48	18-7354	18-7005	18-7233	—
V-150	1990-91 S/N OC239553-OD081999	WMH-1, 7	18-7355	18-7213	—	—
V-150	1992-95 S/N OD082000-OG303045	WMH-13, 13B, 23, 31	18-7355	18-7213	—	—
V-150	1996-98 S/N OG303046-OG760299	WMV-2, 2A	18-7356	18-7214	—	—
V-150	1999 & Sup S/N OG760300 & Sup	WMV-3A, 16, 16A	18-7356	18-7214	—	—
V-150 (XR4, MAGII)	1988 S/N OB242885-OC100860	WH-41A	18-7354	18-7005	18-7233	—
V-150 (XR4, MAGII)	1989 S/N OC100861-OC239552	WH-41	18-7354	18-7005	18-7233	—
V-150 (XR4, MAGII)	1989 S/N OC100861-OC239552	WH-41A	18-7354	18-7005	18-7233	—
V-150 (XR4, MAGII)	1990-91 S/N OC239553-OD081999	WMH-6	18-7355	18-7213	—	—
V-150 (XR6, MAGIII)	1996-98 S/N OG303046-OG760299	WMV-3, 3A	18-7356	18-7214	—	—
V-150 (XR6, MAGIII)	1999 & Sup S/N OG760300 & Sup	WMV-3A, 16, 16A	18-7356	18-7214	—	—
V-150 (XR6, MAGIII)	1992-95 S/N OD082000-OG303045	WMH-14A, 25, 32A	18-7355	18-7213	—	—
V-175	1976-88 S/N 4301235-OC100860	WH-1, 4, 7, 7A, 13, 17, 28, 39, 46	—	18-7005	18-7233	—
V-175	1976-88 S/N 4301235-OC100860	WH-17R, 30, 34	18-7354	18-7005	18-7233	—
V-175	1990 S/N OC100861-OC239552	WH-34	18-7354	18-7005	18-7233	—
V-175	1991 S/N OC239553-OD081999	WMH-2, 11	18-7355	18-7213	—	—
V-175	1992-95 S/N OD082000-OG303045	WMH-15, 22, 33	18-7355	18-7213	—	—
V-175	1996-98 S/N OG303046-OG760299	WMV-4, 4A	18-7356	18-7214	—	—
V-175	1999 & Sup S/N OG760300 & Sup	WMV-4A	18-7356	18-7214	—	—
V200	1978-90	WH-3,14,18,20, 22,26,28,31,39,46	—	—	—	—
		WMH-3	18-7355	18-7213	18-7005	18-7233
V-200	1991 S/N OC291520-OD081999	WMH-3	18-7355	18-7213	—	—
V-200	1992-95 S/N OD082000-OG303045	WMH-16, 21, 34, 39	18-7355	18-7213	—	—
V-200	1996-98 S/N OG303046-OG760299	WMV-5, 5A	18-7356	18-7214	—	—
V-200	1999 & Sup S/N OG760300 & Sup	WMV-5A	18-7356	18-7214	—	—
V200	1980-82 S/N 4839034-OC100860	WH-3A,11	—	18-7005	—	—
V-225 (2.4L)	1981 & Sup 5628028 & Sup	WH-5, 20	—	18-7005	18-7233	—
225	S/N D280813	—	—	—	—	—
	thru G303045	WMH-19,45,46,47	18-7355	18-7213	—	—
V225	1980-81	WH-15	—	18-7005	18-7233	—
V-225 (3.0L)	S/N OD280813-OG303045	WMH-19, 46, 47	18-7355	18-7213	—	—
V-225 (3.0L)	S/N OG303046-OG760299	WMV-7, 13	18-7356	18-7214	—	—
V-225 (3.0L)	S/N OG303046 & Sup	WMV-13, 13A	18-7356	18-7214	—	—
V-225 (3.0L)	S/N OG245605-OG303045	WMH-45	18-7355	18-7213	—	—
Seapro/Marathon		—	—	—	—	—
V-225 (3.0L)	S/N OG303046-OG760299	WMH-6, 11A	18-7356	18-7214	—	—
Seapro/Marathon		—	—	—	—	—
V-225 (3.0L)	S/N todos & Sup	WMV-11, 11A, 13, 13A, 19	18-7356	18-7214	—	—
Seapro/Marathon		—	—	—	—	—
V250	1989-90	WD-8A-1,2,3,4,5,6	—	—	18-7061	—
V275	1989-91	WD-9/9A-1,2,3,4,5,6	—	—	18-7061	—
V300	1980 & Sup S/N 5611648 & Sup	WD-3, 5	—	—	18-7061	—
XR2	S/N C239553-Sup	WHM-1,2,3B,5,7,8, 8A,11A,12,12A,12B, 13,13B,14A,15,16, 18A,21,22,23,24,25, 28,30,31,32,33,34	—	—	—	—
		28,30,31,32,33,34	18-7213	—	—	—
XR4	1988-90	WH-41,WH-41A	—	18-7005	—	—
XR6/ MAGIII	S/N C239553-Sup	WHM-1, 2,3B,5,7,8, 8A,11A,12,12A,12B, 13,13B,14A,15,16, 18A,21,22,23,24,25, 28,30,31,32,33,34	—	—	—	—
		28,30,31,32,33,34	18-7213	—	—	—

 <p>18-8957 VALVULA Reemplaza: 22-8189941, 22-818994</p>	<p>PACK DE 2</p>  <p>18-8956 ACOPLADOR Para manguera de 3/8" to 5/16" Reemplaza: 22-8M0001721</p>	 <p>18-8958 CONECTOR Reemplaza: 22-424254</p>	 <p>18-8866 BOMBA COMBUSTIBLE Reemplaza: 899106T01, 892874T01 Para: Mercury 4 tiempos fueraborda</p>
 <p>18-7804 KIT BOMBA COMBUSTIBLE Reemplaza: 23014A1</p>	 <p>18-7806-1 KIT BOMBA COMBUSTIBLE</p>	 <p>18-7807 KIT BOMBA COMBUSTIBLE Reemplaza: 55278A1</p>	 <p>18-7808 KIT BOMBA COMBUSTIBLE Reemplaza: 55278A5</p>
 <p>18-7809 KIT BOMBA COMBUSTIBLE Reemplaza: 55278A4, 55278A3</p>	 <p>18-7810 KIT BOMBA COMBUSTIBLE Reemplaza: 90363A1</p>	 <p>18-7811 KIT BOMBA COMBUSTIBLE Reemplaza: 89031A1, 66599A1</p>	 <p>18-7812 KIT BOMBA COMBUSTIBLE Reemplaza: 89031A2, 66599A2</p>
 <p>18-7813 KIT BOMBA COMBUSTIBLE Reemplaza: 89031A3, 66599A3</p>	 <p>18-7814 KIT BOMBA COMBUSTIBLE Reemplaza: 89031A4</p>	 <p>18-7815 KIT BOMBA COMBUSTIBLE Reemplaza: 1399-5137</p>	 <p>18-7817 KIT BOMBA COMBUSTIBLE Reemplaza: 21-42990A7, A8, A9, A10, 21-857005A1</p>
 <p>18-7818-1 KIT BOMBA COMBUSTIBLE Reemplaza: 42909A1, 42909A2, 42909A3, 42909A4</p>	 <p>18-7833 MEMBRANA KIT BOMBA Reemplaza: 11497M</p>	 <p>18-7834 MEMBRANA KIT BOMBA Reemplaza: 91748M</p>	 <p>18-7837 MEMBRANA KIT BOMBA Reemplaza: 84262M</p>
 <p>18-7838 MEMBRANA KIT BOMBA Reemplaza: 84265M</p>	 <p>18-7839 MEMBRANA KIT BOMBA Reemplaza: 80606M</p>	 <p>18-7840 MEMBRANA KIT BOMBA Reemplaza: 84141M</p>	 <p>18-7847 MEMBRANA KIT BOMBA</p>

KITS BOMBA COMBUSTIBLE MERCURY

HP	Desde Nº serie	Hasta Nº serie	Kit bomba comb.	HP	Desde Nº serie	Hasta Nº serie	Kit bomba comb.
7.5	3488153	& Sup	18-7815 ②	115 (4 Cil)	B209468	& Sup	18-7818-1 ⑥
8	A197112	& Sup	18-7212	115 (4 Cil)	B209468	& Sup	18-7817 ⑦
9.8	3482753	& Sup	18-7815 ②	115 (115, 1150) SQUARE F/P	6436123	& Sup	18-7817
9.9	A197112	& Sup	18-7212	115 (4 Cil)	D283222	& Sup	18-7817
10	1057994	1455239	18-7804	115 (6 Cil) DFI	G960500	T178999	18-7817
15	1200114	1349667	18-7804	115 (3 Cil) DFI	T801000	& Sup	18-7817
15	B292414	& Sup	18-7212	115 PRO XS	B751825	& Sup	18-7817
20	1866496	2296266	18-7804	120	Todos		18-7806-1
20	3537531	A910970	18-7815 ②	120XR	Todos		18-7806-1
20	6443973	T800749	18-7212	125 (1250) 6 Cil	2314956	2839386	18-7804
20 JET	G044027	& Sup	18-7212	125 (4 Cil)	D283222	& Sup	18-7817
22	1158546	1499331	18-7804	125 (1250BP) 6 Cil	2400058	2641954	18-7817
25	1467499	1499331	18-7804	125 (3 CYL) DFI	B736885	& Sup	18-7817
25	6443973	& Sup	18-7212	135	2839369	3293233	18-7807
30	950250	1448139	18-7804	V-135	C100860	& inf	18-7812 ①
30 JET	C159200	T408999	18-7817	V-135	A904646	& Sup	18-7817 ⑤
35	6445652	& inf	18-7804	V-135 TRIANGULAR F/P	A904646	C100860	18-7813
35	6445653	B110788	18-7809	V-135 SQUARE F/P	A904646	D081999	18-7817
35	B110789	& Sup	18-7817	V-135	D082000	T178499	18-7817
40 (2 cil.)	831021	1476509	18-7804	V-135 DFI (DESIGN II)	G590000	G760299	18-7817
40 (2 Cil)	2874704	5556229	18-7807	V135 DFI	G760300	& Sup	18-7817
40 (2 Cil)	C159200	& Sup	18-7817	140	3293234	3502805	18-7807
40 (2 Cil)	G053314	& Sup	18-7817	140	4865678	5327662	18-7811
40 (3 Cil)	G590000	T999999	18-7817	140 JET	Todos		18-7817
40 4 tiempos JET 2 CICLOS	G760300	& Sup	18-7817	150	3502806	4865677	18-7807
45	1139538	1531958	18-7804	150 EFI	G303046	& Sup	18-7817
45 (4 cil.)	B110789	& Sup	18-7817	V-150	C100860	& inf	18-7812 ①
45/50 (4 cil.)	3478003	B110788	18-7815 ②	V-150	A904646	C100860	18-7817 ⑤
45 JET	6428681	& Sup	18-7817	V-150 XR2	Todos		18-7812
45 JET	D000750	T129554	18-7817	V-150 (150HP)	4868998	A904645	18-7812
50 (4 cil.)	2116318	4357639	18-7804	V-150 SQUARE F/P	A904646	C100860	18-7817
50 (3 cil.)	6428681	B122929	18-7809	V-150	C100861	D081999	18-7817
50 (3 cil.)	B122930	T999999	18-7817	V-150 CARB & EFI	D082000	B226999	18-7817
50/55 (3 cil.)	D000750	& Sup	18-7817	V-150 DFI (DESIGN I)	G590000	G760299	18-7817
60	1072997	1542744	18-7804	V-150 DFI (DESIGN II)	G590000	G760299	18-7817
60	6428681	B122929	18-7809	V-150 DFI	G760300	& Sup	18-7817
60 (3 cil.)	B122930	& Sup	18-7817	V-175	C100860	& inf	18-7812 ①
60 (3 cil.)	D000750	& Sup	18-7817	175 EFI	G303046	G589999	18-7817
65	1542745	2803561	18-7804	V-175	6618751	& Sup	18-7817 ⑤
65	ALL 3 Cil		18-7807	V-175 TRIANGULAR F/P	4301235	C100860	18-7812
65 JET	D283222	& Sup	18-7817	V-175 SQUARE F/P	4301235	& Sup	18-7817
65 (650) 4 Cil	2119749	2803561	18-7804	V-175	C100861	D303045	18-7817
70	1143038	1566239	18-7804	V-175	D303046	G960499	18-7817
70 (3 cil.)	4571652	6428680	18-7809	V-175 EFI	D000750	D081999	18-7817
70 (3 cil)	A996142	C221999	18-7818-1	V-175 EFI	D082000	T408999	18-7817
75 (4 Cil) CUADRADO F/P	6432901	& Sup	18-7817	V-175 EFI	T409000	T800999	18-7817
75 (3 Cil) VÁLVULA 90 GRADOS	C222000	D283221	18-7818-1	V-175 DFI	T178500	& Sup	18-7817
75 (3 Cil) VÁLVULA EN LÍNEA	C222000	D283221	18-7817	V-175 PRO XS	B516339	& Sup	18-7817
75 (3 Cil)	D283222	& Sup	18-7817	200 EFI	G303046	G589999	18-7817
75 (3 Cil) DFI	T980000	& Sup	18-7817	V-200	6073192	6357229	18-7810
75 (4 cil.)	6432901	& Sup	18-7808 ①	V-200	6357230	6625220	18-7814 ①
75 (4 cil.)	6432901	& Sup	18-7817 ⑤	V-200	4839034	6073191	18-7812
75 (3 cil.)	A996142	D283221	18-7818-1	V-200	6625221	& Sup	18-7817 ⑤
80	1335465	2670574	18-7804 ③	V-200	6625221	C291519	18-7817
80	2783253	2856331	18-7807 ③	V-200	C291520	B226999	18-7817
80	2559001	2670574	18-7808 ④	V-200 EFI	C100861	D081999	18-7817
80	4831999	6432900	18-7808	V-200	D082000	T408999	18-7817
80 (3 Cil)	A966142	C221999	18-7818-1	V-200 (2.5L) EFI	T409000	& Sup	18-7817
80 JET (3 Cil)	OD283222	& Sup	18-7817	V-200 (3.0L) EFI	T750164	& Sup	18-7817
80 JET (4 Cil)	B586067	& Sup	18-7817	V-200 DFI	G590000	T598999	18-7817
85	1460999	1766823	18-7804	V-200 DFI	T599000	T5800999	18-7817
85	3493913	4831998	18-7808	V-200 DFI	T801000	& Sup	18-7817
90 (6 cil.)	1766824	4845300	18-7804	V-200 PRO XS	B504989	& Sup	18-7817
90 (6 Cil)	5299506	6436122	18-7811 ①	V-220 LASER	B117316	& Sup	18-7817
90 (6 Cil)	6436123	& Sup	18-7817 ⑤	V-225	5628028	& Sup	18-7810
90 (3 Cil)	A996142	D283221	18-7818-1	V-225 SEA PRO/MARATHON (3.0L)	D208813	& Sup	18-7817
90 (3 Cil) VÁLVULA EN LÍNEA	C222000	D283221	18-7817	V-225 (3.0L) EFI	G129222	& Sup	18-7817
90 (3 Cil) VÁLVULA 90 GRADOS	C222000	D283221	18-7818-1	V-225 (3.0L) DFI	G590000	T598999	18-7817
90 (3 Cil)	D283222	& Sup	18-7817	V-225 DFI	T599000	T800999	18-7817
90 (3 Cil) DFI	T801000	& Sup	18-7817	V-225 DFI	T801000	& Sup	18-7817
95 (950) 6 Cil	1869776	2318585	18-7804	V-225 DTS	T599000	B417701	18-7817
95XR	Todos		18-7806-1	V-225 DTS	B417702	& Sup	18-7817
100	2318586	3253111	18-7804	V-225 PRO XS	B104549	& Sup	18-7817
100 (4 Cil) VÁLVULA 90 GRADOS	B209468	D283221	18-7818-1 ⑥	V-250 (3.4L)	C101891	& Sup	18-7817
100 (4 Cil) VÁLVULA EN LÍNEA	B209468	D283221	18-7817 ⑦	V-250 (3.0L) EFI	G129222	& Sup	18-7817
100 (4 Cil)	D283222	G965520	18-7817	V-250XB	G980600	T800999	18-7817
105 JET	Todos		18-7817	V-250 DFI	B528615	& Sup	18-7817
110	1870204	2314955	18-7804	V-250 PRO XS	B426561	& Sup	18-7817
115	3761034	& inf		V-275 (3.4L)	C101891	& Sup	18-7817
	18-7807			V-300 (3.4L)	5611648	& Sup	18-7812
115 (6 Cil)	5314656	6436122	18-7813 ①	XR4/XR6	C100860	& Inf	18-7817
115 (6 Cil) TRIANGULAR F/P	6436123	& Sup	18-7817 ⑤	Magnum II	Todos		18-7817

① Excepto modelos con bomba combustible cuadrada ④ Aplicaciones bomba comb.simp ⑥ Use con cuerpo bomba comb blan
 ② Modelos de carburadores tillotson BA, BB, BD ⑤ Con bomba comb. cuadrada ⑦ Use con cuerpo bomba comb negr
 ③ Aplicaciones de bomba combustible dual

DIAFRAGMAS MARINER (Modelos japoneses)

Modelo	S/N Cod.	S/N	Diafragmas	Modelo	S/N Cod.	S/N	Diafragmas
5C	6E3	TODOS	18-7834	28	644	M-664-151346 & Sup	②
6C	6H8	TODOS	18-7833	30	689	TODOS	②
6D	6H6	TODOS	18-7833	40 TC	6E9	TODOS	②
8B	677	ML-677-316416 & Sup	18-7837	40A APE	676	M-676-A00346 — 001990	18-7839
8B	677	M-677-012921 & Sup	18-7837	40A APE	676	M-676-A001991 & Sup	②
8C	6G1	TODOS	18-7833	40A APE	676	ML-676-A41356 — 302250	18-7839
9.9C	682	TODOS	①	40A APE	676	ML-676-A302251 & Sup	②
15A	651	TODOS	18-7839	40A APE	676	E-676-A10121 — 100355	18-7839
15C	684	TODOS	①	40A APE	676	E-676-A100356 & Sup	②
20A APE	653	TODOS	18-7839	40A APE	676	EL-676-A50631 — 400940	18-7839
20C TPE	6A9	TODOS	②	40A APE	676	EL-676-A400941 & Sup	②
25A	648	EL-648-550230 & inf	18-7839	40B TPE	676	TODOS	②
25A	648	EL-648-550231 & Sup	②	40C TC	6E9	TODOS	②
25A	648	E-648-26825 & inf	18-7839	48	670	ML-670-302510 & inf	18-7839
25A	648	E-648-26826 & Sup	②	48	670	ML-670-302511 — 311995	②
25A	648	ML-648-304174 & inf	18-7839	48	670	M-670-02640 & inf	18-7839
25A	648	ML-648-304174 & Sup	②	48	670	M-670-02641 — 002160	②
25A	648	M-648-19025 & abajo	18-7839	W48	670	ML-670-311996 & Sup	18-7839
25A	648	M-648-19026 & Sup	②	W48	670	M-670-002161 & Sup	18-7839
25C TPE	695	EL-695-550101 — 555959	②	55	663	EL-663-315379 — 317710	18-7839
25C TPE	695	EL-695-555960 & Sup	18-7839	55	663	EL-663-317711 & Sup	②
25C TPE	695	E-695-250101 — 253861	②	55	663	E-663-004041 — 004317	18-7839
25C TPE	695	E-695-253862 & Sup	18-7839	55	663	E-663-004318 & Sup	②
25C TPE	695	ML-695-300101 — 318173	②	55	663	ML-663-36475 & inf	18-7839
25C TPE	695	ML-695-318174 & Sup	18-7839	55	663	M-663-02730 & inf	18-7839
25C TPE	695	M-695-000101 — 023895	②	W55	663	ML-663-578278 — 583880	18-7839
25C TPE	695	M-695-023896 & Sup	18-7839	W55	663	ML-663-583881 & Sup	②
28	644	EL-664-570795 & inf	18-7839	60 2 CiL	6F0	Todos	18-7839
28	644	EL-664-570796 & Sup	②	60 2 CiL	675	EL-675-30101 — 300280	18-7839
28	644	E-664-270310 & inf	18-7839	60 2 CiL	675	EL-675-300281 — 304180	②
28	644	E-664-270311 & Sup	②	60 2 CiL	675	EL-675-304180 & Sup	18-7839
28	644	ML-664-451125 & inf	18-7839	60 2 CiL	675	E-675-00101 — 000180	18-7839
28	644	ML-664-451126 & Sup	②	60 2 CiL	675	E-675-00181 — 001170	②
28	644	M-664-151345 & inf	18-7839	60 2 CiL	675	E-675-001171 & Sup	18-7839

① Requiere el uso del 18-7837 y 18-7838

② Requiere el uso del 18-7839 y 18-7840

ENSAMBLAJE DE LÍNEA DE COMBUSTIBLE COMPLETA LONG. (2,44 mts)

3/8" **ENSAMBLAJE LÍNEA DE COMBUSTIBLE 18-8010EP-1 SILVERADO 4000 Premium**



*

(SE VENDE POR SEPARADO)

COMPONENTES LINEA COMBUSTIBLE

*

ENSAMBLAJE DE LÍNEA DE COMBUSTIBLE COMPLETA LONG. (2,44 mts)

3/8" **FUEL LINE ASSEMBLY 18-8012EP-1 SILVERADO 4000 Premium OE# 32-858114Q08, 32-858114K08**



*

Conector de 1/4" con rosca en el lado motor y conector de 1/4" con rosca en el lado depósito. Bomba incluida. para otras aplicaciones modificar los conectores.

COMPONENTES LINEA COMBUSTIBLE

*

ENSAMBLAJE DE LÍNEA DE COMBUSTIBLE COMPLETA LONG. (2,44 mts)
3/8" **FUEL LINE ASSEMBLY 18-8024EP-1 SILVERADO 4000 Premium OE# 32-858104Q08, 32-858104K08**



*

Conector rápido en el lado motor y rosca de 1/4" en el lado depósito. Bomba incluida. Para Force 40Hp y posteriores (1993 y posteriores) y todos los Mercury/Mariner.

COMPONENTES LINEA COMBUSTIBLE

*

* Depositos y motores sólo como imagen.

ENSAMBLAJE LÍNEA COMBUSTIBLE COMPLETA LONG. 8'

3/8"
ENSAMBLAJE LÍNEA DE COMBUSTIBLE

18-8025EP-1 *SILVERADO 4000 Premium*

OE# 32-858105Q08,
32-858105K08



*



18-8068
18-8082
CONECTOR

(SE VENDE POR SEPARADO)



18-8084
CONECTOR
GASOLINA



18-8005EP-1
BOMBA
COMBUSTIBLE



18-8076
CONECTOR
GASOLINA



*

COMPONENTES DE ENSAMBLAJE LÍNEA DE COMBUSTIBLE

Compuesto de conector rápido en el lado motor y uno tipo bayoneta en el depósito.

Bomba incluida. Longitud: 2,44 mts. Para Force 40 (1993 & posteriores) 9.9/15/25HP (1998) y todos los Mercury/Mariner.

ENSAMBLAJE LÍNEA COMBUSTIBLE COMPLETA LONG. 8'

3/8"
ENSAMBLAJE LÍNEA DE COMBUSTIBLE

18-8016EP-1 *SILVERADO 4000 Premium*

OE# 32-858109Q12,
32-858109K12



*



18-80402
CONECTOR

(SE VENDE POR SEPARADO)



18-8091
CONECTOR DE
GASOLINA



18-8005EP-1
BOMBA
COMBUSTIBLE



18-8076
CONECTOR
DE GASOLINA



*

COMPONENTES DE ENSAMBLAJE LÍNEA DE COMBUSTIBLE

Compuesto de conector rápido en el lado motor y lado depósito.

Bomba incluida. Longitud: 2,44 mts. Para Force 40 (1993 & posteriores) 9.9/15/25HP (1998) y todos los Mercury/Mariner.

* Tanques y motores sólo a modo ilustrativo

BOMBA COMBUSTIBLE



18-8002EP-1
18-8002EP-1-10①
BOMBA
COMBUSTIBLE 1/4"

18-8004EP-1
18-8004EP-1-10①
BOMBA COMBUSTIBLE
5/16"

Reemplaza: 89396A38,
89396Q38
Bomba de gran capacidad

18-8005EP-1
18-8005EP-1-10①
BOMBA COMB.
3/8"

Reemplaza: 13330A3,
13330Q, 13330Q5
Bomba de gran capacidad

RACOR MANGUERA



REF #	MERCURY OE #	ROSCA	NPT	TIPO CONECTOR
18-8054	22-63186	5/16"	1/8"	Macho
18-8055	22-63187	5/16"	1/4"	Macho
18-8073	-	3/8"	1/8"	Macho
18-8074	-	3/8"	1/4"	Macho

① Descuento en tienda por pack de 10 - Precio por pack



18-7083
BOMBA COMBUSTIBLE
 Reemplaza: 858763, 8168773, 8168772, 8168771, 816877, 684311
 Para: 30 2cil (Todos), 30 JET 3 cil. (Todos), 40 2 cil. (Todos), 40 3 cil. (Todos), 40 JET(Todos), 50 3 cil. (G590000 & Sup), 55 3 cil. (G590000 & Sup), 60 3 cil. (G590000 & Sup), 60 3cil Bigfoot (Todos), 65 JET (Todos), 75 3 cil. (D283222 & Sup), 90 3 cil. (D283222 & Sup)



18-80410
CONECTOR COMBUSTIBLE
 Reemplaza: 22-13563T3
 Racor manguera hembra 5/16"
 Para: 4/5 2-Tiempos (1999 & Sup)
 Se adapta 18-80412



18-80412
CONECTOR COMBUSTIBLE
 Reemplaza: 22-816856T2
 Conector manguera macho 5/16"
 Para: 100 4-cil. (1988-99), 115 4-cil. (1989 & Sup), 125 4-cil. (1994 & Sup), 65 Jet (1994 & sup), 75 3-cil. (1987 & Sup), 80 Jet (1994 & Sup), 90 3-cil. (1987 & Sup)
 se adapta 18-80410



18-8068
CONECTOR
 (1/4" NPT)
 (Hembra)



18-8069
CONECTOR COMBUSTIBLE
 5/16"
 Reemplaza: 22831Q3, 22831A3, 22831A4, 22831B3, 22831A1
 (Hembra)



18-8070
FUEL CONNECTOR
 5/16"
 Reemplaza: 30185A3, 30185Q3, 30185B3, 30185A1, 29196, 16610M
 (Macho)



18-8075
CONECTOR COMBUSTIBLE
 (1/4")
 Reemplaza: 22-14213M, 2214213Q, 22-81042M
 Se adapta 18-8077-1



18-8076
18-8076-10^①
CONECTOR COMBUSTIBLE
 (3/8")
 Reemplaza: 22-13563A3, 22-13563Q3
 Se adapta 18-8077-1



18-8077-1
18-8077-1-10^①
CONECTOR
 (1/4" NPT)
 Se adapta 18-8075, 18-8076, 18-8085



18-8082
DEPÓSITO CONECTOR
 Conector Mercury recto
 (1/4" NPT)
 (Hembra)



18-8083
CONECTOR COMBUSTIBLE
 3/8"
 (Hembra)



18-8084
CONECTOR COMBUSTIBLE
 3/8"
 Reemplaza: 30185A3, 30185Q3, 30185B3, 30185A1, 29196, 22-16610M
 (Hembra)



18-8085
18-8085-10^①
CONECTOR COMBUSTIBLE
 (5/16")
 Se adapta 18-8077-1



18-8091
CONECTOR COMBUSTIBLE
 (3/8")
 Reemplaza: 22-13563Q7, 22-13563T7, 22-13563A7
 22-13563A6
 Se adapta 18-80402



18-80402
CONECTOR COMBUSTIBLE
 (1/4" NPT)
 Se adapta 18-8091

① Descuento en tienda por pack de 10 - Precio por pack

THE **LARGEST** SELECTION IN THE **MARINE INDUSTRY**

No one offers more coverage
for Rotating Electrical products
than Sierra. Over 400 products
including:

- Alternators
- Starters
- Trim Motors
- Solenoids
- Rectifiers
- Accessories



Sierra
Marine Engine and Drive Parts

- DISEÑO UNIVERSAL -
REEMPLAZO DIRECTO PARA MERCURY Y YAMAHA
SOPORTE FILTRO GASOLINA



Tipo de soporte	Ref #	Reemplaza	Tipo de soporte	Ref #	Reemplaza
1/4" acero inoxidable	18-7777		1/4" Aluminio	18-7853-1	Mercury 89876A3, 89876, 55481
3/8" acero inoxidable	18-7776		3/8" Aluminio	18-7775	

KIT FILTROS GASOLINA



KIT FILTROS DE 21 MICRONES PARA MOTORES CARBURACIÓN

TIPO DE KIT	Ref #	Capacidad Filtrado	Contenido	Reemplaza
1/4" Aluminio (Filtro corto)	18-7848-1	21	1 - 18-7844 filtro & 1 18-7853-1 soporte 2 - 18-4256 1/4" tapones	35-807172A4, Q4, 35-60494A4, 35-805369A4, 35-57250A1, 35-55501A1, 35-52456A1, 35-60494A1, 52444
1/4" Aluminio Bonus Pack Contiene filtro de repuesto	18-7848-2	21	2 - 18-7844 filtro & 1 18-7853-1 soporte 2 - 18-4256 1/4" tapones	
1/4" Aluminio (Filtro alto)	18-7852-1	21	1 - 18-7845 filtro & 1 18-7853-1 soporte 2 - 18-4256 1/4" tapones	
1/4" Aluminio Bonus Pack Contiene filtro de repuesto	18-7852-2	21	2 - 18-7845 filter & 1 18-7853-1 soporte 2 - 18-4256 1/4" tapones	
3/8" Aluminio (Filtro alto)	18-7775-1	21	1 - 18-7845 filter & 1 18-7775 soporte 2 - 18-4264 3/8" tapones	
1/4" acero inoxidable (Filtro alto)	18-7777-1	21	1 - 18-7845 filtro & 1 18-7777 soporte 2 - 18-4256 1/4" tapones	
3/8" acero inoxidable (Filtro alto)	18-7776-1	21	1 - 18-7845 filtro & 1 18-7776 soporte 2 - 18-4264 3/8" tapones	

KITS FILTROS 10 MICRONES PARA MOTORES DE INYECCIÓN



Tipo de kit	Ref #	Capacidad filtrado	Contenido
1/4" Aluminio (Filtro corto)	18-7983-1	10	1 - 18-7944 filtro & 1 18-7853-1 soporte • 2 - 18-4256 1/4" tapones
1/4" Aluminio Bonus Pack (Contiene filtro de repuesto)	18-7983-2	10	2 - 18-7944 filtro & 1 18-7853-1 soporte • 2 - 18-4256 1/4" tapones
1/4" Aluminio (Filtro alto)	18-7982-1	10	1 - 18-7945 filtro & 1 18-7853-1 soporte • 2 - 18-4256 1/4" tapones
1/4" Aluminio Bonus Pack (Contiene filtro de repuesto)	18-7982-2	10	2 - 18-7945 filtro & 1 18-7853-1 soporte • 2 - 18-4256 1/4" tapones
1/4" Aluminio (Gran capacidad Filtro)	18-7966-1	10	1 - 18-7866 filtro & 1 18-7853-1 soporte • 2 - 18-4256 1/4" tapones
3/8" Aluminio (Filtro alto)	18-7986-1	10	1 - 18-7945 filtro & 1 18-7775 soporte • 2 - 18-4264 3/8" tapones
1/4" Acero inoxidable (Filtro alto)	18-7984-1	10	1 - 18-7945 filtro & 1 18-7777 soporte
3/8" Acero inoxidable (Filtro alto)	18-7985-1	10	1 - 18-7945 filtro & 1 18-7776 soporte • 2 - 18-4264 3/8" tapones
1/4" Aluminio (Filtro alto)	18-79912	10	1 - 18-79911 & 1 - 18-7853-1



KIT FILTROS 10 MICRONES CON VASO DECANTADOR

El vaso transparente Sierra AquaVue™ se usa para fueraborda e instalaciones en cubierta. El vaso metálico antiinflamable se usa para instalaciones bajo cubierta. Los filtros con vaso decantador transparente o metálico permiten drenar el agua, alargando la vida útil del elemento filtrante.

Tipo Kit	Ref #	Capacidad filtrado	Contenido
1/4" Aluminio c/ vaso AquaVue™	18-7932-1	10	1 - 18-7919 filtro & 1 18-7853-1 Soporte 1 - 18-7922-1 vaso AquaVue™ 2 - 18-4256 1/4" tapones
1/4" Aluminio c/ cazoleta desagüe	18-7951	10	1 - 18-7919 filtro & 1 18-7853-1 soporte 1 - 18-7924 Cazoleta metálica 2 - 18-4256 1/4" tapones
1/4" Acero inoxidable c/ vaso AquaVue™	18-7937-1	10	1 - 18-7919 filtro & 1 18-7777 soporte 1 - 18-7922-1 vaso AquaVue™ 2 - 18-4256 1/4" tapones
1/4" Acero inoxidable c/ cazoleta desagüe	18-7938	10	1 - 18-7919 filtro & 1 18-7777 Soporte 1 - 18-7924 cazoleta metálica 2 - 18-4256 1/4" tapones

SOPORTE COMPACTO Y KIT SEPARADOR PARA PEQUEÑOS FUERABORDA Y APLICACIONES EN AGUA DULCE



18-7774
SOPORTE DE ALUMINIO COMPACTO

18-7965-1
KIT SEPARADOR 10 MICRONES COMPACTO
Contiene:
1 - 18-7774 soporte
1 - 18-7865 filtro



FILTROS REPUESTO



DISEÑO UNIVERSAL- REPUESTO DIRECTO PARA MERCURY AND YAMAHA

FILTRO DE REPUESTO 10 MICRONES			FILTRO DE REPUESTO 10 MICRONES		
Ref #	Descripción	Reemplaza	Ref. #	Descripción	Reemplaza
18-7944	Corto - 3.875"	35-807172, 35-802893Q, 35-806771, 35-8053691, 35-805369, 35-604941, 35-60494, 35-57250, 35-55501, 35-52456,	18-79911	Largo - 8.5"	35-8M0079962
18-7945	Largo - 4.35"	35-802893Q, 35-806771, 35-8053691, 35-805369, 35-604941, 35-60494, 35-57250, 35-55501, 35-52456	FILTRO DE REPUESTO 21 MICRONES		
18-7866	Gran capacidad - 6"		18-7844	corto- 3.875"	35-807172, 35-807172, 35-806771,
18-7865	10 micrones compacto		18-7845	Largo - 4.35"	35-8053691, 35-60494A4, 35-604941, 35-57250, 35-55501
18-7967	Primeros modelos c/ sensor	35-18458Q3, 35-18458A3, 35-18458A2, 35-17808A1, 35-14571A1	<p>18-8955 TAPA Para: 18-7944 & 18-7945 filtro</p>		
18-7968	Ultimos modelos c/ sensor	35-18458Q4, 35-184585			
<p>FILTROS DE REPUESTO 10 MICRONES CON VASO DECANTADOR (CONSULTE LA TABLA DE ABAJO)</p>					

FILTROS DE REPUESTO			FILTROS Y KITS CAZOLETAS	
Ref #	Descripción	Reemplaza	Ref. #	Descripción
18-7919	Elemento filtrante	35-809097, 35-8M0103095 Racor S3213	18-7928-1	Filtro & vaso AquaVue™ Estilo Mercury Contiene: 18-7919 filtro, vaso18-7922-1
18-7920	Elemento filtrante	35-809099 Racor S3214	18-7929	Filtro & Cazoleta metálica Estilo Mercury Contiene: 18-7919 filtro, vaso18-7924
18-7948	Elemento filtrante Para - 320RRAC01	35-886638 Racor S3227	18-7969	Filtro & cazoleta metálica Contiene: 18-7948 filtro, vaso18-7924
REPUESTO DE VASO DECANTADORES			18-7994-1	Filtro & vaso AquaVue™ Contiene: 18-7948 filtro, vaso18-7922-1
Part #	Descripción			
18-7922-1	Recipiente AquaVue™			
18-7924	Recipiente metal			

<p>18-7936 ELEMENTO FILTRO COMBUSTIBLE Reemplaza: 35-888289T2 Para: 225 EFI (2003-06) (SN 0T653945 & Sup)</p>	<p>18-7712 FILTRO COMBUSTIBLE (EN LÍNEA) Reemplaza: 35-16248 Para: 4/5 2 cil (1999 & Sup), 4/5/6 4 tiempos (1999 & Sup), 8/9,9 4-tiempos (2005 & Sup)</p>	<p>18-7713 FILTRO COMBUSTIBLE (EN LÍNEA) Reemplaza: 35-80365M Para: Mercury/Mariner 9.9 4-tiempos (1995-98), 15 4-tiempos (1998 & Sup), Yamaha 6 (1989, 1992-99), 8 (1989-99, 2001-02), F4 (1999-02), F9.9 (1989-95, 1997-99, 2001-02), FT 9.9 (1988-90)</p>
<p>18-7714 FILTRO COMBUSTIBLE (EN LÍNEA) Reemplaza: 35-877565T1 Para: 25 4-tiempos (1998 & Sup), 30 4-tiempos (1999-01), 30 3 cil 4-Tiempos (1999-01), 40 4-Tiempos (1998-01), 40 4. tiempos 4 cil (2001-02), 40 Carb 3-cil 4-tiempos (2002 & Sup), 50 4-tiempos 4 cil (2001-02), 60 4-tiempos 4 cil (2001-02), 75 4-tiempos (2000 & Sup), 90 4-tiempos (2000 & Sup)</p>	<p>18-7718 FILTRO COMBUSTIBLE (EN LÍNEA) 5/16" Reemplaza: 35-879885T Para: 135/150/175 4-tiempos Verado (S/N 1B227000 & Sup), 200/225 4-tiempos Verado (S/N 0T980000 & Sup), 250/275 4-tiempos Verado (S/N 0T801000 & Sup)</p>	<p>18-7802 FILTRO COMBUSTIBLE Reemplaza: 35-87946A3, 35-87946-Q3, Q4 Para: 6 HP hasta 25 HP</p>
<p>18-7832 FILTRO COMBUSTIBLE Reemplaza: 1399-3938, 1399-1754, 1399-1136 Para: AJ, KA, KB, KC, KD, WM, WMC Carb.</p>	<p>18-7979 FILTRO COMBUSTIBLE Reemplaza: 881540 Para: 115 EFI (4 tiempos), 75HP (4 tiempos), 75HP (4 tiempos) (Bodensee), 90HP (4 tiempos)</p>	<p>18-7981 FILTRO COMBUSTIBLE Reemplaza: 35-884380T, 35-8M0020349 Para: Todos Verados, 90HP (DFI) (3 cil), 115 DFI (3 cil) / 200HP (DFI) / 225HP (DFI) (incluida 3.0L DFI)</p>



FILTRO COMB.

Ref #	Aplicación
18-7828-1	1/4" Pequeña capacidad (Para 1/4" manguera)
18-7829	1/4" gran capacidad (para 1/4" manguera) Reemplaza: 35-16494, 35-816296, 35-816296T, 35-816296K03
18-7830	5/16" Reemplaza: 35-164941, 35-816296-1, 35-816296T1, 35-8162961, 35-816396Q1 35-816296B2, 35-816296B1, 35-134301
18-7831	3/8" Reemplaza: 802128A1

PACK DE 10



18-7113-9²
ARO TÓRICO
Reemplaza: 25-897536, 25-98277
Para: Filtro 18-7802 (35-87946Q3)



18-7997
FILTRO DE AIRE
Reemplaza: 35-853333T, 35-853333
Para: V115 DFI (2.5L) (2000), V-135 DFI (2.5L) (1998 & Sup), V-150 DFI (2.5L) (1998 & Sup), V-175 DFI (2.5L) (2001 & Sup), 200 DFI (1998-02), 225 DFI (1998-02)



18-7999
FILTRO DE AIRE
Reemplaza: 35-896247
Para: 135/150/175 4-tiempos Verado (S/N 1B227000 & Sup)



18-3605
KIT TERMOSTATO
Para: V-135 DFI (2.5L)(1998 & Sup), V-150 DFI (2.5L)(1998 & Sup), V-175 DFI (2.5L)(2000 & Sup)



18-3606
KIT TERMOSTATO 130°
Para: 200 3.0L DFI DTS (Todos), 200 3.0L EFI (2003 & Sup)(OT750164 & Sup), 200 DFI (1997 & Sup)(OG386496 & Sup), 225 3.0L EFI (1999 & Sup)(OG760300 & Sup), 225 3.0L EFI SeaPro (2004 & Sup)(OT801000 & Sup), 225 3.0L DFI DTS (2003 & Sup)(OT599000 & Sup), 225 DFI (1998 & Sup)(OG590000 & Sup), 250 3.0L EFI (1999 & Sup) (OG760300 & Sup), 250 Largo 3.0L EFI (OT861319 & Sup)

① 18-3606D 



18-43175
KIT TERMOSTATO 130°
Reemplaza: 855676002
Para: Mercury 15 Carb(2cil) 4-Tiempos(R235949& Sup), 15 SeaPro 4-Tiempos(R051685 & Sup), 20 Carb(2cil)4-tiempos(R235168 & Sup), 25 EFI(3cil)4-tiempos(R106999 & Sup), 25 Jet EFI(3cil)4-tiempos(R165086 & Sup), 25 SeaPro 4-tiempos (R051710 & Sup), 30 EFI(3cil)4-tiempos(T409000-1B226999), 8 4-tiempos(209cc)(R042475 & Sup), 9.9 4 tiempos(209cc)(R042475 & Sup)



18-3672
KIT TERMOSTATO
— CONTIENE —

Ref #	Desc.	O.E. #
18-3553	Termostato, latón	75692
18-0182	Junta termostato	27-62386

HP	Desde S/N	Hasta S/N	HP	Desde S/N	Hasta S/N
V135	A904646 & Sup	V150 MAGII	C239553	4571651	
V150	A904646 & Sup	V150 MAGIII	D082000	4825248	
V150 XR4	C239553	C159199	V175	C100861 & Sup	
V150 XR6	D082000 & Sup	V200	6435503 & Sup		

① 18-3672D 



18-3569
KIT TERMOSTATO
Reemplaza: 803061T1
Incluye 18-3549 termostato

HP	Desde S/N	Hasta S/N	HP	Desde S/N	Hasta S/N
70 3 cil.	A996142 & Sup	100 4 cil.	B209468	& Sup	
75 3 cil.	C222000 & Sup	115 4 cil.	C100000	& Sup	
80 3 cil.	A996142 & Sup	125 4 cil.	D283222	& Sup	
90 3 cil.	A996142 & Sup				



18-43052
KIT TERMOSTATO
Reemplaza: 14586A3, 75962A9, 75962A10, 75962A11
Para: Mercury 6-25 hp 2-Tiempos



18-3534
TERMOSTATO 110°
Reemplaza: 850055, 850055001
Para: 40 3cil (1998 & Sup), 40 Jet (2000 & Sup), 50 3cil (1986 & Sup), 55 3cil (1996 & Sup), 60 3cil (1984 & Sup)



18-3535
TERMOSTATO 130°
Reemplaza: 885599004
Para: 200 3.0L DFI DTS (Todos), 200 3.0L EFI (2003 & Sup)(OT750164 & Sup), 200 DFI (1997 & Sup)(OG386496 & Sup), 225 3.0L EFI (1999 & Sup)(OG760300 & Sup), 225 3.0L EFI SeaPro (2004 & Sup) (OT801000 & Sup), 225 3.0L DFI DTS (2003 & Sup)(OT599000 & Sup), 225 DFI (1998 & Sup)(OG590000 & Sup), 250 3.0L EFI (1999 & Sup)(OG760300 & Sup), 250 Largo 3.0L EFI (OT861319 & Sup)



18-3536
TERMOSTATO 143°
Reemplaza: 833072003
Para: V135 DFI 2.5L (1998 & Sup) (OG590000 & Sup), V150 DFI 2.5L (1998 & Sup)(OG590000 & Sup), V175 DFI 2.5L (2001 & Sup)(OT178500 & Sup)



18-3537
TERMOSTATO 143°
Reemplaza: 833072002, 833072004
Para: 75 3 cil DFI 1.5L (2006 & Sup) (OT980000 & Sup), 90 3 cil DFI 1.5L (2004 & Sup)(OT801000 & Sup), 115 3 cil DFI 1.5L (2004 & Sup)(OT801000 & Sup)

① Referencias acabadas en D envasadas
② Precio envasado



18-3553
TERMOSTATO
Reemplaza: 62981, 66850, 75692
143°

18-3553 APLICACIÓN TERMOSTATO					
HP	Desde	Hasta	HP	Desde	Hasta
7.5	5226935	& Sup	V150	A904646	& Sup
9.8	5206550	& Sup	V175	C100861	& Sup
40	3336258	C159199	V200	6435503	& Sup
50/60	D000750	& Sup	V220	B117316	& Sup
65	3547987	4571651	V225	5628028	& Sup
70	4571652	4825248	V300/3.4L	5611648	& Sup
70/75/80/90	A996142	& Sup	XR4	C239553	D081999
100/115	B209468	& Sup	Magnum II	C239553	D081999
V135	A904646	& Sup			



18-3549
TERMOSTATO
Reemplaza: 14586
Para: 6, 7, 8, 9.9 & 15 HP
Mercury/Mariner A197112 & posterior
120°

18-3549 APLICACIÓN TERMOSTATO		
MARINER		
HP	Serie #	
6,8,9,9 (2 cil.)	A197112	posterior
Sea Pro 10	D038000	posterior
15 (2 cil.)	B292414	posterior
18XD, 20XD, 25XD	B114231	posterior
25 (2 cil.) 25 Sea Pro	B238464	posterior
30 (2 cil.)	G055314	posterior
45 Jet, 50, 55, 60 (3 cil.)	G290585	posterior
MERCURY		
Sea Pro 10	D038000	posterior
15 (2 cil.)	B292414	posterior
18XD, 20XD, 25XD	B114231	posterior
25 (2 cil.) 25 Sea Pro	B238464	posterior
30 (2 cil.)	G055314	posterior
45 Jet, 50, 55, 60 (3 cil.)	G290585	posterior



18-3631
ALOJAMIENTO TERMOSTATO
Reemplaza: 892864T04
Para: 135-300 Verado



18-3556
TERMOSTATO
Reemplaza: 895338
3/4" - 130°



18-43051
KIT TAPA TERMOSTATO
Para: Mercury V6



18-5896
SENSOR DE TEMPERATURA
Reemplaza: 12415
1/8" - 27NPT rosca



18-3007
18-3007-10①
IMPULSOR
Reemplaza: 47-89983, 47-89983T



18-3008
IMPULSOR
Reemplaza: 47-20813, 47-25287



18-3012
IMPULSOR
Reemplaza: 47-22748



18-3017
18-3017-10 ①
IMPULSOR
Reemplaza: 47-89984, 47-899842, 47-89984T3, 47-89984T4, 47-899844, 47-30221, 47-65960, 47-85460



IMPULSOR

Ref #	ID	Reemplaza:
18-3039	.456"	47-65957, 47-89981, 47-39074
18-3054	.438"	47-68988, 47-89980



18-3052
IMPULSOR
Reemplaza: 47-56780, 47-65958, 47-89982



18-3056
18-3056-10①
IMPULSOR
Reemplaza: 47-430261, 47-430262, 47-43026T2, 47-430264



18-3057
IMPULSOR
Reemplaza: 47-85089-3



18-3062
IMPULSOR
Reemplaza: 47-420381, 47-420382, 47-42038Q02



18-3063
IMPULSOR
Reemplaza: 47-95611M, 47-81242M



18-3066
IMPULSOR
Reemplaza: 47-11590M



18-3067
IMPULSOR
Reemplaza: 47-84797M, 47-81604M



18-3069
IMPULSOR
Reemplaza: 47-81423M, 47-97108M, 47-82824M



18-3072
IMPULSOR
Reemplaza: 47-80395M

APLICACIONES COMIENZAN EN LA PÁGINA 174
① Descuento en tienda pack de 10 - Precio por pack

 <p>18-3073 IMPULSOR Reemplaza: 47-96305M</p>	 <p>18-3074 IMPULSOR Reemplaza: 47-84027M, 47-84027T, 47-96619M</p>	 <p>18-3098 IMPULSOR Reemplaza: 47-161543, 47-16154</p>	 <p>18-45312 IMPULSOR Reemplaza: 47-95289, 47-952892 Para: Mercury 2(T884302 & Sup), 2.5(A855097 & Sup), 3.3(G710613 & Sup)</p>	
 <p>18-8900 IMPULSOR Reemplaza: 47-19453</p>	 <p>18-3293 CHAVETA Reemplaza: 28-43037</p>	 <p>18-3294 CHAVETA Reemplaza: 28-81603M</p>	 <p>18-3300 CHAVETA Reemplaza: 28-83444M Para: 40A, 40B, 40C</p>	 <p>18-3305 CHAVETA Reemplaza: 28-81912M, 28-83070M, Para: 6C-D, 8C, 9.9C, 15C</p>
 <p>18-3109 TUBO GUÍA Reemplaza: 23-29804, 23-29804T, 23-52928 (Usar con alojamiento 18-3116)</p>	 <p>18-3013 RETÉN BOMBA DE AGUA Reemplaza: 26-821309 Para: 4-tiempos O/B's, 25/30/40/45/50 HP s/n OG760300 & Sup</p>	 <p>18-3110 CASQUILLO Reemplaza: 26-38970, 26-36557A1, 26-29677 (Parte del alojamiento 18-3116)</p>	 <p>18-3014 RETÉN BOMBA DE AGUA Reemplaza: 26-821310 Para: 4-Tiempos O/B's, 25/30/40/45/50 HP s/n OG760300 & Sup</p>	 <p>18-3151 ALOJAMIENTO Reemplaza: 816597</p>
<p>Pack de 5</p>  <p>18-3227 18-3227-9 CLAVIJA BASE BOMBA DE AGUA Reemplaza: 17-35973 Para: 20-225HP S/N 1866496-Sup</p>	 <p>18-1730 ACOPLAMIENTO Reemplaza: 43585 Para: 200, 225, 250 & 275 Verado</p>	 <p>18-3113 ALOJAMIENTO Reemplaza: 70977</p>	 <p>18-3114 ALOJAMIENTO Reemplaza: 48752, 48752T</p>	 <p>18-3115 ALOJAMIENTO Reemplaza: 48753</p>
 <p>18-3435 ALOJAMIENTO TURBINA</p>	 <p>18-3107 PLATINA IMPULSOR Reemplaza: 54705, 32768</p>	 <p>18-3117 IMPULSOR PLATINA Reemplaza: 32435, 324351, 30605</p>	 <p>18-3122 IMPULSOR PLATINA Reemplaza: 817276, 8172761, 8172763</p>	
 <p>18-3139 IMPULSOR PLATINA Reemplaza: 46895</p>	 <p>18-3436 IMPULSOR PLATINA</p>	 <p>18-3116 ALOJAMIENTO BOMBA Reemplaza: 46-96418, 46-96148A1, 46-96148T1, 46-64141A1, 46-48743A1</p>	 <p>18-3118 ALOJAMIENTO BOMBA Reemplaza: 46-48746A1, 46-77822A1, 46-48746A3</p>	



18-3414
BASE BOMBA
Reemplaza: 46-96146A5, 46-73804A1



18-3416
BASE BOMBA
Reemplaza: 46-96146A6, 46-96146A2, 46-78400A1, 46-73802A2



18-3419
BASE BOMBA
Reemplaza: 46-42579A3



18-3422
BASE BOMBA
Reemplaza: 46-77516A1, 46-73842A2, 46-68390A1, 46-65498A1, 46-48745A1



18-3423
BASE BOMBA
Reemplaza: 46-73640A1



18-3424
BASE BOMBA
Reemplaza: 46-77177A1



18-3445
BASE BOMBA
Reemplaza: 46-812966A7, 46-812996A3, 46-812996A9
Para: 40-60 HP



18-43212
ALOJAMIENTO BOMBA
Reemplaza: 46-803750A02, 46-8037502
Para: Mercury 8/9.9 4-tiempos(209cc)



18-3207D 
KIT REPARACIÓN IMPULSOR
Reemplaza: 47-89983T2, 47-89983Q1
— CONTIENE —

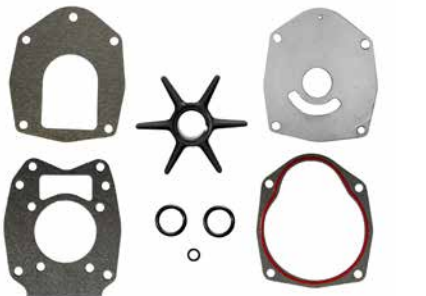

18-3214D 
KIT REPARACIÓN IMPULSOR
Reemplaza: 47-43026T6, 47-43026T8, 47-43026T11
— CONTIENE —

Ref #	Descripción	O.E. #	Cant.
18-3007	Impulsor	47-89983	1
18-2945	Junta drenaje	12-20260,12-19183	2
18-2823	Junta bomba de agua	27-32769, 27-19553	1
18-2824	Junta cuerpo de bomba	27-32770	1
18-2825	Junta bomba de agua	27-32771,27-19551	1
18-2841	Junta bomba de agua	27-77417,27-19552	1
18-2948	Arandela goma	12-49221-1	1
18-3107	Platina	54705	1
18-7155	Aro tórico	25-26855	1
18-7174	Aro tórico	25-45711	1
18-7115	Aro tórico	25-26722	1

ref #	Descripción	O.E. #	Cant.
18-2564	Base bomba agua platina	27-43033-1	1
18-2565	Base bomba de agua alojamiento	27-43047-1	1
18-2566	Platina tapa bomba agua	27-817277	1
18-2944	Retén	26-45577	1
18-3056	Impulsor	47-43026-1	1
18-3122	Impulsor	817276	1
18-7420	Aro tórico	25-21836	1



18-3215D 
KIT REPARACIÓN IMPULSOR
Reemplaza: 47-85089T7
— CONTIENE —



18-3149-1
KIT BOMBA DE AGUA
Reemplaza: 46-42040A1, 46-42040A3, 46-42040A5, 46-42040T5
Para: 10 Magnum, Marathon, Sea Pro, Viking
15 Marathon, Sea Pro 6, 8, 9.9HP, XR10

Ref #	Descripción	O.E. #	Cant.
18-2560	Junta impulsor	12-86645	2
18-2561	Alojamiento platina	27-85087	1
18-2562	Alojamiento platina	27-99326-1	1
18-3057	Impulsor	47-85089-3	1
18-7419	Aro tórico	25-69202	1

ref #	Descripción	O.E. #	Cant.
18-2564	Base bomba agua platina	27-43033-1	1
18-2565	Base bomba de agua alojamiento	27-43047-1	1
18-2566	Platina tapa bomba agua	27-817277	1
18-2944	Retén	26-45577	1
18-3056	Impulsor	47-43026-1	1
18-3122	Impulsor	817276	1
18-7420	Aro tórico	25-21836	1

APLICACIONES COMIENZAN EN LA PÁGINA 174

① Referencias acabas de D envasadas



**18-3265
KIT REPARACIÓN IMPULSOR**

Reemplaza: 47-43026Q06, 47-43026T11, 47-8M0100526
 Para: 135/150/175 4-tiempos Verado (S/N 1B227000 & Sup), 200/225 4-Tiempos Verado (S/N OT980000 & Sup), 250/275 4-tiempos Verado (S/N OT801000 & Sup)



①18-3217D

**18-3217
KIT IMPULSOR**

Reemplaza : 46-96148A5 sin base o alojamiento
 — CONTIENE —

Ref #	Descripción	O.E. #	Cant.
18-3109	Tubo de agua	23-29804	1
18-3017	Impulsor	47-89984	1
18-2919	Junta bomba de agua	27-42631-1	1
18-3110	Casquillo	26-38970	1
18-2945	Junta drenaje	12-20260,12-19183	2
18-2826	Base bomba agua alojamiento	27-85610	1
18-2914	Junta bomba de agua	27-85608-1	1
18-2915	Junta bomba de agua	27-85609-1	1
18-2944	Retén	26-45577	1
18-3117	Platina	32435	1
18-7158	Aro tórico	25-30613	1
18-7162	Aro tórico	25-33145	1
18-7173	Aro tórico	25-30224	1
18-7176	Aro tórico	25-90011	1
18-2801	Junta bomba de agua	27-32438	1
18-7426	Aro tórico	35-30271	1

①18-3239D



**18-3239
KIT REPARACIÓN IMPULSOR**

— CONTIENE —

Ref #	Descripción	O.E. #	Cant .
18-3039	Impulsor	47-89981	1
18-3139	Impulsor platina	46895	1
18-7409	Aro tórico	—	1



**18-3252
KIT REPARACIÓN IMPULSOR**

Reemplaza: 47-89982T1

— CONTIENE —

Ref #	Descripción	O.E. #	Cant.
18-2004	Retén aceite	26-20070	2
18-2006	Retén aceite	26-897154	1
18-2827	Junta platina superior	27-39623	1
18-2828	Junta platina superior	27-39625	1
18-3052	Impulsor	47-89982	1
18-7164	Aro tórico	25-33466	1



**18-3406
KIT REPARACIÓN BOMBA DE AGUA**

Reemplaza: 817275A08
 Para: 135/150/175 4-tiempos Verado (S/N 1B227000 & Sup), 200/225 4-tiempos Verado (S/N OT980000 & Sup), 250/275 4-tiempos Verado (S/N OT801000 & Sup)



**18-3407
KIT REPARACIÓN BOMBA DE AGUA**

Reemplaza: 817275A09
 Para: 135/150/175 4-tiempos Verado (S/N 1B227000 & Sup), 200/225 4-tiempos Verado (S/N OT980000 & Sup), 250/275 4-tiempos Verado (S/N OT801000 & Sup)



**18-3314
KIT BOMBA DE AGUA**

— CONTIENE —

Ref #	Descripción	O.E. #	Cant.
18-3109	Tubo de agua	23-29804	1
18-3017	Impulsor	47-89984	1
18-3116	Alojamiento	46-96148A1	1
18-3414	Base	46-96146A5	1
18-2919	Junta bomba de agua	27-42631-1	1
18-3110	Casquillo	26-38970	1
18-2945	Junta drenaje	26-20260, 12-19183	2
18-2826	Base alojamiento	27-85610-1	1
18-2914	Junta bomba de agua	27-85608-1	1
18-2915	Junta bomba de agua	27-85609-1	1
18-2944	Retén	26-45577	1
18-3117	Platina	32435	1
18-7158	Aro tórico	25-30613	1
18-7162	Aro tórico	25-33145	1
18-7173	Aro tórico	25-30224	1
18-7176	Aro tórico	25-90011	1
18-2801	Junta	27-32438	1
18-7426	Aro tórico	35-30271	1

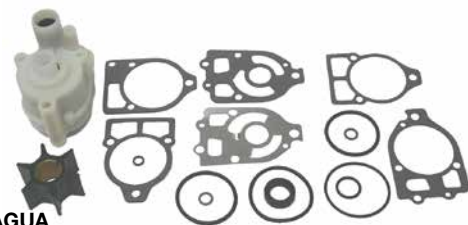

**18-3316
KIT BOMBA DE AGUA**

Reemplaza: 46-78400A2, 46-96148A8, 46-32437A3

— CONTIENE —

Ref #	Descripción	O.E. #	Cant.
18-3109	Tubo de agua	23-29804	1
18-3017	Impulsor	47-89984	1
18-3116	Alojamiento	46-96148A1	1
18-3416	Base	46-96146A6	1
18-2919	Junta bomba de agua	27-42631-1	1
18-3110	Casquillo	26-38970	1
18-2945	Junta drenaje	26-20260, 12-19183	2
18-2826	Base alojamiento	27-85610-1	1
18-2914	Junta bomba de agua	27-85608-1	1
18-2915	Junta bomba de agua	27-85609-1	1
18-2944	Retén	26-45577	1
18-3117	Platina	32435	1
18-7158	Aro tórico	25-30613	1
18-7162	Aro tórico	25-33145	1
18-7173	Aro tórico	25-30224	1
18-7176	Aro tórico	25-90011	1
18-2801	Junta	27-32438	1
18-7196	Aro tórico	25-38099	1
18-7426	Aro tórico	35-30271	1



**18-3319
KIT BOMBA DE AGUA**

Reemplaza: 46-42579A4

— CONTIENE —

Ref #	Descripción	O.E. #	Cant.
18-3109	Tubo de agua	23-29804	1
18-3017	Impulsor	47-89984	1
18-3116	Alojamiento	46-96148A1	1
18-3419	Base	46-42579A3	1
18-2919	Junta bomba de agua	27-42631-1	1
18-3110	Casquillo	26-38970	1
18-2945	Junta drenaje	26-20260, 12-19183	2
18-2826	Base alojamiento	27-85610-1	1
18-2914	Junta bomba de agua	27-85608-1	1
18-2915	Junta bomba de agua	27-85609-1	1
18-2944	Retén	26-45577	1
18-3117	Platina	32435	1
18-7158	Aro tórico	25-30613	1
18-7162	Aro tórico	25-33145	1
18-7173	Aro tórico	25-30224	1
18-7176	Aro tórico	25-90011	1
18-2801	Junta	27-32438	1
18-7426	Aro tórico	35-30271	1

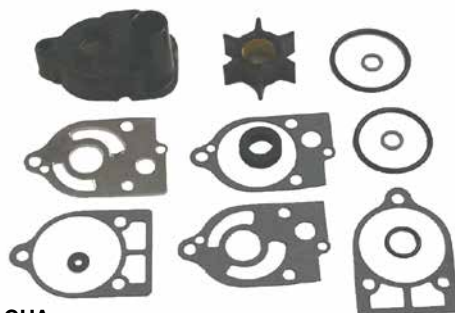

**18-3507
KIT BOMBA DE AGUA**

(Sin base)

Reemplaza: 46-60366A1

— CONTIENE —

Ref #	Descripción	O.E. #	Cant.
18-3007	Impulsor	47-89983	1
18-3118	Alojamiento bomba superior	46-77822A1	1
18-2945	Junta drenaje	12-20260, 12-19183	2
18-2823	Base bomba agua inf. platina	27-32769, 27-19553	1
18-2824	Platina superior a cueroi	27-32770, 27-19551	1
18-2825	Junta bomba de agua	27-32771	1
18-2841	Junta bomba de agua	27-77417, 27-19552	1
18-2948	Tapón drenaje	12-49221-1	1
18-3107	Platina	54705	1
18-7155	Aro tórico	25-26855	1
18-7174	Aro tórico	25-45711	1
18-7115	Aro tórico	25-26722	1

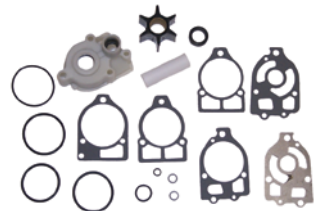

**18-3517
KIT BOMBA DE AGUA**

(sin base)
Reemplaza: 46-96148A5, 46-96148A8, 46-78400A2, 46-73804A3, 46-73802A3, 46-69222A3, 46-64141A11, 46-60367A4, 46-58618A4, 46-57234A3, 46-48747A3, 46-42579A4, 46-44292A4, 46-32437A1

— CONTIENE —

Ref #	Descripción	O.E. #	Cant.
18-3109	Tubo de agua	23-29804	1
18-3017	Impulsor	47-89984	1
18-3116	Alojamiento	46-96148A1	1
18-2919	Junta bomba de agua	27-42631-1	1
18-3110	Casquillo	26-38970	1
18-2945	Junta drenaje	26-20260, 12-19183	2
18-2826	Base alojamiento	27-85610-1	1
18-2914	Junta bomba de agua	27-85608-1	1
18-2915	Junta bomba de agua	27-85609-1	1
18-2944	Retén	26-45577	1
18-3117	Platina	32435	1
18-7158	Aro tórico	25-30613	1
18-7162	Aro tórico	25-33145	1
18-7173	Aro tórico	25-30224	1
18-7176	Aro tórico	25-90011	1
18-2801	Junta bomba de agua	27-32438	1
18-7426	Aro tórico	35-30271	1



**18-3322
KIT BOMBA DE AGUA**

Reemplaza: 46-77516A3

— CONTIENE —

Ref #	Descripción	O.E. #	Cant.
18-3007	Impulsor	47-89983	1
18-3118	Alojamiento	46-77822A1	1
18-3422	Base bomba de agua	46-77516A1	1
18-2945	Junta drenaje	12-20260, 12-19183	2
18-2823	Base bomba agua inf. platina	27-32769, 27-19553	1
18-2824	Platina superior a cuerpo	27-32770, 27-19551	1
18-2825	Junta bomba de agua	27-32771	1
18-2841	Junta bomba de agua	27-77417, 27-19552	1
18-2948	Tapón drenaje	12-49221-1	1
18-3107	Platina	54705	1
18-7155	Aro tórico	25-26855	1
18-7174	Aro tórico	25-45711	1
18-7115	Aro tórico	25-26722	1



18-3323
KIT BOMBA DE AGUA
Reemplaza: 46-73640A2

— CONTIENE —

Ref #	Descripción	O.E. #	Cant.
18-3007	Impulsor	47-89983	1
18-3118	Alojamiento bomba superior	46-77822A1	1
18-3423	Base bomba de agua	46-73640A1	1
18-2945	Junta drenaje	12-20260, 12-19183	2
18-2823	Base bomba agua inf. platina	27-32769, 27-19553	1
18-2824	Platina superior a cuerpo	27-32770, 27-19551	1
18-2825	Junta bomba de agua	27-32771	1
18-2841	Junta bomba de agua	27-77417, 27-19552	1
18-2948	Tapón drenaje	12-49221-1	1
18-3107	Platina	54705	1
18-7155	Aro tórico	25-26855	1
18-7174	Aro tórico	25-45711	1
18-7115	Aro tórico	25-26722	1

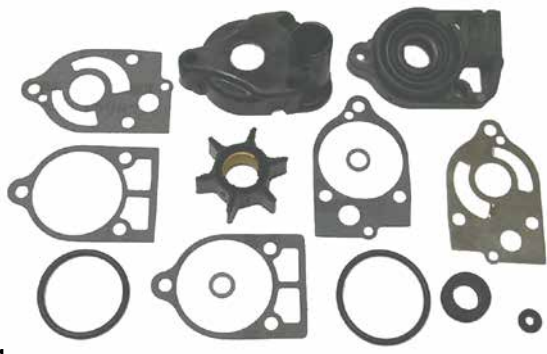

18-3324
KIT BOMBA DE AGUA
Reemplaza: 46-77177A3

— CONTIENE —

Ref #	Descripción.	O.E. #	Cant.
18-3007	Impulsor	47-89983	1
18-3118	Alojamiento bomba superior	46-77822A1	1
18-3424	Base bomba de agua	46-77177A1	1
18-2945	Junta drenaje	12-20260, 12-19183	2
18-2823	Base bomba agua inf. platina	27-32769, 27-19553	1
18-2824	Platina superior a cuerpo	27-32770, 27-19551	1
18-2825	Junta bomba de agua	27-32771	1
18-2841	Junta bomba de agua	27-77417, 27-19552	1
18-2948	Tapón drenaje	12-49221-1	1
18-3107	Platina	54705	1
18-7155	Aro tórico	25-26855	1
18-7174	Aro tórico	25-45711	1
18-7115	Aro tórico	25-26722	1

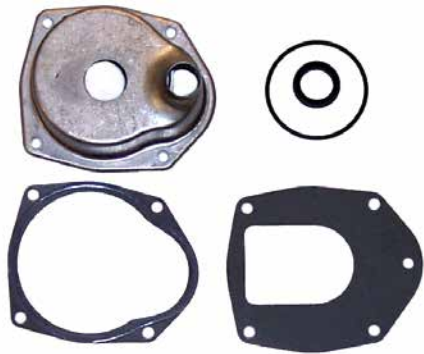

18-3571
KIT ALOJAMIENTO BOMBA
Reemplaza: 817275A1
V-6 fueraborda



18-3572
KIT ALOJAMIENTO BOMBA
Reemplaza: 46-43024A3, 817275A2



18-3148
KIT REPARACIÓN BOMBA DE AGUA
Sin alojamiento
Reemplaza: 46-84277M, 46-84277T

— CONTIENE —

Ref #	Descripción	O.E. #	Cant.
18-0768	Junta disco de desgaste	—	1
18-3074	Impulsor	47-84027M	1
18-3305	Chaveta impulsor	28-8192M	1



18-3446
KIT BOMBA DE AGUA
Reemplaza: 46-70941A3
Para: 4/4.5 HP

— CONTIENE —

Ref #	Descripción	O.E. #	Cant.
18-3039	Impulsor	47-89981	1
18-3139	Impulsor platina	46895	1

18-3448
KIT BOMBA DE AGUA
 Reemplaza: 46-48744A3
 Para: 20 HP 1967-80

— CONTIENE —

Ref #	Descripción	O.E. #	Cant.
18-3052	Impulsor	47-89982	1
18-2827	Junta platina superior	27-39623	1
18-2828	Junta platina inferior	27-39625	1
18-2829	Junta bomba de agua	27-39626	1



18-3570
KIT BOMBA DE AGUA

— CONTIENE —

Ref #	Descripción	O.E. #	Cant.
NSS	Alojamiento bomba de agua	—	1
18-3056	Impulsor	47-430262	1
18-2599	Retén	26-816575A2	1
18-3122	Impulsor platina	817276	1



18-3425
KIT BOMBA DE AGUA
 Sin alojamiento
 Reemplaza: 84188M, 84188T

— CONTIENE —

Ref #	Descripción	O.E.#	Cant.
18-0292	Junta platina alojamiento	27-81417M	1
18-3435	Tapa	—	1
18-0294	Junta platina alojamiento	—	1
18-3069	Impulsor	47-81423M, 47-97108M	1
18-0256	Tornillo	—	2
18-3436	Impulsor platina	—	1
18-3297	Llave impulsor	—	1

HP	Desde S/N	Hasta S/N	HP	Desde S/N	Hasta S/N
817275A2 APLICACIÓN					
40 (4 tiempos)			817275A2 APLICACIÓN (Cont.)		
(4 cil.) Bigfoot	OT228405	& Sup	80 Jet	OD283222	& Sup
50 (4 tiempos)			90 (3 cil.)	OA996142	& Sup
935cc Big Foot	OG231123	OT178499	90 (4 tiempos)	OG960500	& Sup
50 (4 tiempos)			100 (4 cil.)	OB209468	& Sup
996cc Big Foot	OT178500	& Sup	115 (4 cil.)	OC100000	& Sup
60 (3 cil.)			125 (4 cil.)	OD283222	& Sup
Bigfoot	OD000750	& Sup	817275A1 APLICACIÓN		
60 (4 tiempos)			45 (4 tiempos)		
Bigfoot	OT178500	& Sup	Bigfoot Bodensee	OG231123	& Sup
65 Jet	OC283222	& Sup	V-200 DFI (3.0L)	OG386496	OG589999
70 (3 cil.)	OA996142	& Sup	V-200 DFI (3.0L)	OG590000	& Sup
75 (3 cil.)	OC222000	& Sup	V-225 (3.0L)		
75 (4 tiempos)	OG960500	& Sup	Carb & EFI	OD280813	& Sup
80 (3 cil.)	OA996142	& Sup	V-225 DFI	OG590000	& Sup
			V-250 (3.0L) EFI	OG129222	& Sup

18-3426
KIT BOMBA DE AGUA
 Sin alojamiento
 Reemplaza: 42431M, 84829M, 97793M, 97793T

— CONTIENE —

Ref #	Descripción	O.E.#	Cant.
18-3067	Impulsor	47-84797M	1
18-3294	Llave impulsor	28-81603M	1



18-3427
KIT BOMBA DE AGUA
 Sin alojamiento
 Reemplaza: 81242M, 95661M

— CONTIENE —

Ref #	Descripción	O.E.#	Cant.
18-0773	Junta disco desgaste	—	1
18-3067	Impulsor	47-84797M	1
18-3294	Llave impulsor	28-81603M	1

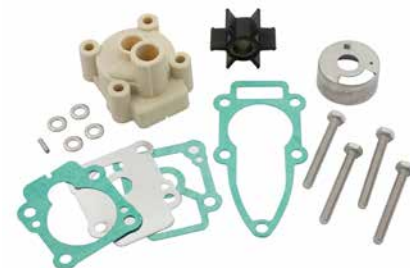

18-48317
KIT COMPLETO BOMBA DE AGUA
 Reemplaza: 46-803750A03, 46-80375A03
 Para: Mercury 8-9.9 4-tiempos (209cc)(R042475 & Sup)

APLICACIÓN SISTEMA REFRIGERACIÓN MARINER

Modelos Mariner	S/N Codigo	S/N	Impulsor	Platina	Tapa impulsor	Kit reparación impulsor	Kit completo
2A	646	Todos	18-3072	—	—	—	—
2B	6A1	Todos	18-3072	—	—	—	—
4A	6E0	Todos	18-3073	—	—	—	—
5C	6E3	Todos	18-3073	—	—	—	—
6C	6H8	Todos	18-3066	—	—	—	—
6D	6H6	Todos	18-3066	—	—	—	—
8A(M)	655	000000-000300	18-3063	—	—	—	—
8A(ML)	655	000000-300101	18-3063	—	—	—	—
8B(M)	677	000101 & Sup	18-3063	—	—	—	—
8B(ML)	677	300101 & Sup	18-3063	—	—	—	—
8C	6G1	Todos	18-3066	—	—	—	—
9.9C	682	Todos	18-3074	—	—	18-3148	—
15A(M)	651	000285 & Inf	18-3063	—	—	—	—
15A(ML)	651	3000100 & Inf	18-3063	—	—	—	—
15C	684	Todos	18-3074	—	—	18-3148	—
20C(M)	6A9	000101-005810	18-3067	18-3436	—	18-3426	—
20C(ML)	6A9	300101-306542	18-3067	18-3436	—	18-3426	—
20C(E)	6A9	250101-250819	18-3067	18-3436	—	18-3426	—
20C(EL)	6A9	550101-550693	18-3067	18-3436	—	18-3426	—
20C(M)	6A9	010112 & Sup	18-3067	—	—	—	18-3427
20C(ML)	6A9	306543 & Sup	18-3067	—	—	—	18-3427
20C(E)	6A9	250820 & Sup	18-3067	—	—	—	18-3427
20C(EL)	6A9	550694 & Sup	18-3067	—	—	—	18-3427
25C(M)	695	000101-014870	18-3067	18-3436	—	—	18-3426
25C(ML)	695	000000-312185	18-3067	18-3436	—	—	18-3426
25C(E)	695	000000-252290	18-3067	18-3436	—	—	18-3426
25C(EL)	695	000000-553575	18-3067	18-3436	—	—	18-3426
25C(M)	695	014871 & Sup	18-3067	—	—	—	18-3427
25C(ML)	695	312186 & Sup	18-3067	—	—	—	18-3427
25C(E)	695	252291 & Sup	18-3067	—	—	—	18-3427
25C(EL)	695	553576 & Sup	18-3067	—	—	—	18-3427
28	664	Todos	18-3067	—	—	—	—
30	689	Todos	18-3067	—	—	—	—
30A(M)	689	000366-014805	18-3067	18-3436	—	—	18-3426
30A(ML)	689	301911-315315	18-3067	18-3436	—	—	18-3426
30A(E)	689	100251-103275	18-3067	18-3436	—	—	18-3426
30A(EL)	689	401216-407815	18-3067	18-3436	—	—	18-3426
30A(M)	689	022059 & Sup	18-3067	—	—	—	18-3427
30A(ML)	689	321377 & Sup	18-3067	—	—	—	18-3427
30A(E)	689	105325 & Sup	18-3067	—	—	—	18-3427
30A(EL)	689	411947 & Sup	18-3067	—	—	—	18-3427
48/48W	670	Todos	18-3069	18-3436	18-3435	18-3425	—
55/W55	663	Todos	18-3069	18-3436	18-3435	18-3425	—
60	675,6F0	Todos	18-3069	18-3436	18-3435	18-3425	—

MERCURY APLICACIONES SISTEMA DE REFRIGERACIÓN

HP	Desde Nº serie	Hasta Nº serie #	Impulsor	Impulsor Platina	Tapa	Aloj. Superior	Base	Kit reparación imp.	Termostato	Kit Superior	Kit Completo
3.3 (con recambio)	D901217	& Sup	18-3098								
3.5	358136	6202172	18-3012								
3.5	6202173	& Sup	18-3054								
3.6	5404657	& Sup	18-3054								
3.9	1655013	2498135	18-3012	18-3139							
4 (1 cil.)	2498136	4107219	18-3039	18-3139				18-3239			
4 (2 cil.)	5589202	& Sup	18-3054	—							
4 (made in USA)	5595532	A809600	18-3054	18-3139							
4 (made in USA)	5595532	& Sup	18-3039	18-3139		18-3446		18-3239			18-3446
4 (1 cil.)	A809601	& Sup	18-3098							—	
4.5	4107220	5595531	18-3039	18-3139				18-3239			18-3446
4.5	5595532	& Sup	18-3054	18-3139							
4.5	5595532	& Sup	18-3039	18-3139				18-3239			18-3446
5	574128	786612	18-3012								
5 (1 cil.)	A809601	& Sup	18-3098								
5 4-tiempos	R000001	& Sup	18-3098								
6	888005	1916138	18-3012								
6	1916139	2193817	18-3039	18-3139				18-3239			
6	A197112	QT800749	18-3062								
6	1582403	1916138	18-3039								
6	1916139	2193817	18-3039								
6	2193818	2529894	18-3039								
6	2385673	2387383	18-3039								
7.5	2529895	4131609	18-3039	18-3139							
7.5	4131610	5226934	18-3039	18-3139				18-3239			18-3446
7.5	5206550	& Sup	18-3054								
7.5	5206550	& Sup	18-3039	18-3139				18-3239			18-3446

- 1 Modelos con alojamiento sup. bomba aluminio
- 2 Modelos con bomba agua aluminio
- 3 Modelos con alojamiento bomba agua plástico
- 4 Modelos con bomba agua plástico
- 5 Bomba tornillos sin aislador
- 6 Bomba tornillos con aislador
- 7 Modelos con tuerca retenedor
- 8 Modelos sin tuerca retenedor
- 9 Modelos con agujero enjuage
- 10 Modelos sin agujero enjuagee
- 11 Modelos con alojamiento superior plástico
- 12 Unidades cambio bomba usando 46-46893A 6 se debe usar 2193818-2529894
- 13 Unidades cambio bomba usando 46-46893A 6 se debe usa USA 3795658-4126549
- 14 Unidades cambio bomba usando 46-46893A 6 se debe usa "Early Mariner Impellers"

APLICACIÓN SISTEMA REFRIGERACIÓN MERCURY

HP	Desde nº Serie #	Hasta nº Serie #	Impulsor	Impulsor Platina	Tapa	Aloj. Superior	Base	Kit repar. Impulsor	Termostato	Kit Superior	Kit Completo
8	A197112	& Sup	18-3062								
8 (4-Tiempos Bodensee)	G760300	& Sup	18-3062								
110 (9.8)	1865779	2196388	18-3039								
110 (9.8)	2196389	3795657	18-3039								
110 (9.8)	3795658	4126459	18-3039								
110 (9.8) 3	4126460	5206549	18-3039	18-3139				18-3239			
110	5206550	& Sup	18-3054								—
9.8	5206550	& Sup	18-3039	18-3139				18-3239	18-3553		18-3446
9.9	A197112	& Sup	18-3062								
9.9 (4 tiempos) STANDARD CASE	G760300	T979999	18-3062								
XR10 SeaPro	D038000	& Sup	18-3062						18-3549		
10	500022	1057993	18-3008								
15	B292414	& Sup	18-3062						18-3549		
15 SeaPro	G044365	& Sup	18-3062								
16	700000	& Sup	18-3008								
18	5837437	& Sup	18-3057								
20	860970	1292909	18-3008								
20	2827677	6443972	18-3052					18-3252			18-3448
20	6443973	T800749	18-3057					18-3215			
22	1158546	1238089	18-3008								
25,25XD,25 Sea Pro	5705532	& Sup	18-3057					18-3215			
25 (3 cil.)	E268781	& Sup	18-3057					18-3215			
30	950250	1260724	18-3008					—			
30	1271884	1448139	18-3007	18-3107				18-3207		18-3507	—
30 Jet	C159200	G589999	18-3007	18-3107	18-3115	18-3118	18-3424	18-3207		18-3507	18-3324
30 Jet	G590000	& Sup	18-3057								
30 (2 cil)	G053314	T598999	18-3057								
35	1217222	1448139	18-3007	—			—	—		—	—
35	1571114	1960826	18-3007	18-3107				18-3207		18-3507	—
35	1960827	2453068	18-3007	18-3107				18-3207		18-3507	—
35	6445653	& Sup	18-3007	18-3107	18-3115	18-3118	18-3424	18-3207		18-3507	18-3324
40	941751	1224480	18-3008	—	—	—	—	—		—	—
40	1224481	1476509	18-3007	—	—	—	—	—		—	—
40	2874704	4362214	18-3007	18-3107	18-3115	18-3118	18-3422	18-3207		18-3507	18-3322
40 (2 cil) hasta 1983	4860103	& Sup	18-3057	18-3107	18-3115	18-3118	18-3424	18-3207		18-3507	18-3324
40 (3 cil)	G531301	& Sup	18-3057	—	—	—	—	—		18-3507	—
40 (4 cil)	C159200	& Sup	18-3007	18-3107	18-3115	18-3118	18-3424	18-3207			
40 (4-tiempos) 2:1 ratio	G760300	T408999	18-3057								
40 (EFI 4-tiempos) 1.83:1 ratio	T409000	& Sup	18-8900				18-3445				
40 (EFI 4-tiempos) 2.31:1 ratio	T409000	B344398	18-3056					18-3214			
40 (4-tiempos, 4 cil.) 2.31:1 ratio	T228405	T598999	18-3056					18-3214			
40 (4-tiempos, Std)	G231123	T178499	18-3057								
40 4-tiempos Carb BIG FOOT	C033811	& Sup	18-3056								
40	1279685	1476509	18-3007							18-3507	
45	5531630	& Sup	18-3007	18-3107	18-3115	18-3118	18-3424	18-3207			
45 Jet (3 cil)	D000750	& Sup	18-8900								
45 (4-tiempos, std) Bodensee		G231123 & Sup	18-3057								
45 (4-tiempos, bigfoot) Bodensee	G231123	& Sup	18-3056					18-3214			
50	1421113	1460498	18-3007							18-3507	
50	1477910	1521913	18-3007								
50	1521914	2305100	18-3007	18-3107				18-3207		18-3507	
50 aluminio w/p	2305101	2478119	18-3007								
50 plástico w/p	2305101	2478119	18-3007								
500	2514919	4357639	18-3007	18-3107	18-3115	18-3118	18-3422	18-3207		18-3507	
50 (4cil)	4357640	5531629	18-3007	18-3107	18-3115	18-3118	18-3423	18-3207		18-3507	
50 (4cil)	5531630	& Sup	18-3007			18-3118					
50 (4 cil)	4962056	& Sup	18-3007	18-3107	18-3115	18-3118	18-3424	18-3207		18-3507	
50 (3 cil)	6428681	D000749	18-3007	18-3107	18-3115	18-3118	18-3424	18-3207			
50 (3 cil)	D000750	G589999	18-8900				18-3445		18-3553		
50 (3 cil)	G590000	& Sup	18-3057								
50 (4-tiempos, Std)	G231123	T178499	18-3057								
50 (4-tiempos, 4 cil.) STANDARD	T178500	T598999	18-8900				18-3445				
50 (4-tiempos, 4 cil.) BIG FOOT	T178500	& Sup	18-3056			18-3572		18-3214			
50 (EFI 4-tiempos) STANDARD	T409000	B344398	18-8900				18-3445				
50 (EFI 4-tiempos) BIG FOOT	T409000	B344398	18-3056					18-3214			
55 (3 cil)	D000750	& Sup	18-8900				18-3445				
60	6428681	D000749	18-3007	18-3107	18-3115	18-3118	18-3424	18-3207			18-3324
60 (3cil) standard	D000750	& Sup	18-3056	18-3122				18-3214	18-3553		
60 Marathon	D000750	& Sup	18-3056	18-3122				18-3214			
60 Big Foot	D000750	& Sup	18-3056	18-3122				18-3214	18-3553		
60 (3 cil)	D000750	& Sup	18-8900						18-3553		
60 4-tiempos STANDARD	OT178500	T598999	18-8900				18-3445	18-3214			
60 4-tiempos, BIG FOOT	OT178500	T598999	18-3056					18-3214			
60 4-tiempos EFI BIG FOOT	T409000	B344398	18-3056								

- 1 Modelos con alojamiento sup. bomba aluminio
- 2 Modelos con bomba agua aluminio
- 3 Modelos con alojamiento bomba agua plástico
- 4 Modelos con bomba agua plástico
- 5 Bomba tornillos sin aislador
- 6 Bomba tornillos con aislador
- 7 Modelos con tuerca retenedor

- 8 Modelos sin tuerca retenedor
- 9 Modelos con agujero enjuage
- 10 Modelos sin agujero enjuagee
- 11 Modelos con alojamiento superior plástico
- 12 Unidades cambio bomba usando 46-46893A 6 se debe usar 2193818-2529894
- 13 Unidades cambio bomba usando 46-46893A 6 se debe usa USA 3795658-4126549
- 14 Unidades cambio bomba usando 46-46893A 6 se debe usa "Early Mariner Impellers"

MERCURY APLICACIONES SISTEMA DE REFRIGERACIÓN

HP	Desde nº Serie #	Hasta nº Serie #	Impulsor	Impulsor Platina	Tapa	Aloj. Superior	Base	Kit repar. Impulsor	Termostato	Kit superior	Kit Completo
65 (4 cil) aluminio w/p	1542745	280351	18-3017	18-3117	18-3114			18-3217		18-3507	
65 (4cil) plastico w/p	1542745	280351	18-3017			18-3116					
65 (4cil)	2803562	2874263	18-3017			18-3116					
65 (4cil)	2997439	3293183	18-3017			18-3116					
65(3 cil)	3293184	4382056	18-3007	18-3107	18-3115	18-3118	18-3422	18-3207		18-3507	
65(3 cil)	4382057	4571651	18-3007	18-3107	18-3115	18-3118	18-3424	18-3207			
65 Jet	0D283222	& Sup	18-3056	18-3122				18-3214			
70	1413611	1436114	18-3017	18-3117				18-3217		18-3507	
70 (6cil)	1482212	1503458	18-3017								
700 E-2 (6cil)	1503459	1503958	18-3017								
700 EL-2 (6cil)	1503459	1566239	18-3017								
700 E-2 (6cil)	11 1503959	1566239	18-3017			18-3116					
700 EL-2 (6cil)	11 1505111	1566239	18-3017			18-3116					
70 (3 cil)	4571652	4977156	18-3007	18-3107	18-3115	18-3118	18-3423	18-3207	18-3553	18-3507	
70	4977157	6428680	18-3007	18-3107	18-3115	18-3118	18-3424	18-3207			
70	B110054	& Sup	18-3056					18-3214			18-3517
70 (3cil)	6 A996142	C221999	18-3056			18-3572			18-3553		
70 (3cil)	5 A996142	C221999	18-3056			18-3572			18-3553		
75 (4 cil)	6432901	& Sup	18-3017	18-3117	18-3114	18-3116	18-3414	18-3217			
75 (3 cil)	A996142	C221999	18-3056					18-3214	18-3553		
75 (3 cil)	C222000	& Sup	18-3056					18-3214	18-3569		
75 (3 cil)	C222000	& Sup	18-3056	18-3122				18-3214	18-3569		
75 (3cil) Optimax	T980000	& Sup	18-3056			18-3572					
75 4-Tiempos	G960500	B366822	18-3056					18-3214			
75 4-Tiempos	B366823	& Sup	18-3056			18-3572					
80	1355468	3493912	18-3017	18-3117				18-3217			18-3517
80 (6cil)	1335465	1398629	18-3017								
80 (4 cil)	4831999	6432900	18-3017	18-3117	18-3114	18-3116	18-3414	18-3217			
80 (3 cil)	6 A996142	C221999	18-3056					18-3214	18-3553		
80 (3 cil)	5 A996142	C221999	18-3056			18-3572			18-3553		
80 Jet	D283222	& Sup	18-3056	18-3122				18-3214			
850 E & EL (6cil)	1460999	1567039	18-3017	18-3117				18-3217			18-3517
850 E-1, EL-1 (6cil)	11 1566240	1766823	18-3017								
85 (4 cil)	4590512	& Sup	18-3017	18-3117	18-3114	18-3116	18-3414	18-3217			
85 XS (4cil)	3493913	4831998	18-3017			18-3116					
850 XS (4cil)	3493913	4831998	18-3017			18-3116					
850, 850 XS (4cil)	3493913	4590511	18-3017			18-3116					
900 (90hp) (6 cil)	11 1766824	1869775	18-3017	18-3117				18-3217			18-3517
90 (6 cil)	4845301	& Sup	18-3017	18-3117	18-3114	18-3116	18-3414	18-3217			
90 (3 cil)	B110054	C221999	18-3056					18-3214			
90 (3 cil)	A996142	& Sup	18-3056					18-3214	18-3553		
90 (3 cil)	A996142	& Sup	18-3056	18-3122				18-3214	18-3553		
90 4-Tiempos	G960500	B366822	18-3056			18-3572		18-3214			
90 4-Tiempos	B366823	& Sup	18-3056			18-3572		18-3214			
95	1869776	2318585	18-3017	18-3117				18-3217			
115 (3CIL) Optimax	T801000	& Sup	18-3056			18-3572					
950 (95hp) (6 cil)	11 1869776	2318585	18-3017								
1000(6 cil)	1464949	1503331	18-3017	18-3117				18-3217			
1000 (6cil)	1503332	2318585	18-3017			18-3116					
100 (4 cil)	B209468	& Sup	18-3056					18-3214	18-3553		
100 (4 cil)	B209468	& Sup	18-3056	18-3122				18-3214	18-3553		18-3517
1000 SS (6cil)	1 2318586	2413843	18-3017			18-3116					
1000 SS (6cil)	3 2318586	2413843	18-3017			18-3116					
1000 SS E-1	1 2484633	2836018	18-3017			18-3116					
1000 SS E-1	3 2484633	2836018	18-3017			18-3116					
1000 BP (6cil)	2399698	3253111	18-3017			N.L.A.					
105 Jet	0D182000	& Sup	18-3017	18-3117	18-3114	18-3116	18-3419	18-3217			
110	1 1870204	2314955	18-3017	18-3117				18-3217			
110	3 1870204	2314955	18-3017			18-3317					
115 (6cil)	2836019	4112634	18-3017	18-3117				18-3217			18-3517
115 (6cil)	4112635	4394236	18-3017								
115 (6 cil)	4394237	& Sup	18-3017	18-3117	18-3114	18-3116	18-3414	18-3217			
115 (4 cil)	6 C100000	& Sup	18-3056					18-3214	18-3569		
115 (4cil)	5 C100000	& Sup	18-3056			18-3572			18-3569		
115 (4 cil)	B209468	& Sup	18-3056	18-3122				18-3214			
115 4-Tiempos	T178500	B366822	18-3056					18-3214			
115 4-Tiempos	B366823	& Sup	18-3056			18-3572					
115 (3cil) Optimax	T801000	& Sup	18-3056			18-3572					
115 Pro XS	B751825	& Sup	18-3056			18-3572					
125 (6cil)	2 2314956	2839368	18-3017	18-3117				18-3217			
125 (6cil)	4 2314956	2839368	18-3017								
125 (4 cil)	6 D283222	& Sup	18-3056						18-3569		
125 (4cil)	5 D283222	& Sup	18-3056			18-3572					
125 (3cil) Optimax	B736885	& Sup	18-3056			18-3572					

- 1 Modelos con alojamiento sup. bomba aluminio
- 2 Modelos con bomba agua aluminio
- 3 Modelos con alojamiento bomba agua plástico
- 4 Modelos con bomba agua plástico
- 5 Bomba tornillos sin aislador
- 6 Bomba tornillos con aislador
- 7 Modelos con tuerca retenedor
- 8 Modelos sin tuerca retenedor
- 9 Modelos con agujero enjuage
- 10 Modelos sin agujero enjuagee
- 11 Modelos con alojamiento superior plástico
- 12 Unidades cambio bomba usando 46-46893A 6 se debe usar 2193818-2529894
- 13 Unidades cambio bomba usando 46-46893A 6 se debe usa USA 3795658-4126549
- 14 Unidades cambio bomba usando 46-46893A 6 se debe usa "Early Mariner Impellers"

MERCURY APLICACIÓN SISTEMA DE REFRIGERACIÓN

HP	Desde nº Serie #	Hasta nº Serie #	Impulsor	Impulsor Platina	Tapa	Aloj. Superior	Base	Impulsor Repar. kit	Termostato	Kit Superior	Kit completo
135	2839369	3293233	18-3017	18-3117				18-3217			18-3517
V 135	904646	& Sup	18-3017	18-3117	18-3114	18-3116	18-3419	18-3217			—
135 4-tiempos VERADO	B227000	& Sup	18-3056			18-3572					18-3407
140	3293234	3502805	18-3017	18-3117				18-3217			18-3517
140	4865678	& Sup	18-3017	18-3117	18-3114	18-3116	18-3414	18-3217			18-3517
140 Jet	D082000	& Sup	18-3017	18-3117	18-3114	18-3116	18-3419	18-3217			—
150	3502806	4121434	18-3017	18-3117				18-3217			18-3517
150 (6cil) 9	4121435	4865677	18-3017	18-3117	18-3114	18-3116	18-3414	18-3217			18-3517
150 (6cil) 10	4121435	4865677	18-3017				18-3414				
1500 XS (6cil)	4868648	5327662	18-3017								
V 150	A904646	& Sup	18-3017	18-3117	18-3114	18-3116	18-3419	18-3217			18-3517
V 150	A904645	& Inf	18-3017	18-3117	18-3114	18-3116	18-3416	18-3217			18-3517
V-135 DFI	G590000	& Sup	18-3017								
V-150 Carb 8	4868998	A904645	18-3017								
V-150 Carb 7	4868998	A904645	18-3017								
V-150 Carb, EFI, DFI	A904646	& Sup	18-3017								
V-150XR2,4,6 - MAGNUM II, III 8	4868998	& Sup	18-3017								
V150XR2,4,6 - MAGNUM II, III 7	4868998	& Sup	18-3017								
150 4-tiempos VERADO (4cil)	B227000	& Sup	18-3056			18-3572				18-3406	18-3407
V 175	6618751	& Sup	18-3017	18-3117	18-3114	18-3116	18-3419	18-3217			18-3517
V 175	4301235	6618750	18-3017	18-3117	18-3114	18-3116	18-3416	18-3217			18-3517
V-175 Carb, EFI, DFI	6618751	& Sup	18-3017								
175 4-tiempos VERADO (4cil)	B227000	& Sup	18-3056			18-3572				18-3406	18-3407
V 200	6625221	& Sup	18-3017	18-3117	18-3114	18-3116	18-3419	18-3217			18-3517
V-200 8	4839034	6625220	18-3017	18-3117	18-3114	18-3116	18-3416	18-3217			—
V-200 7	4839034	6625220	18-3017								
V-200 DFI (3.0L)	G386496	G589999	18-3056					18-3214			18-3517
V-200 EFI (3.0L)	T750164	B504988	18-3056								
V-200 Carb, & EFI (2.5L)	6625221	& Sup	18-3017								
V-200 DFI (3.0L)	G590000	T598999	18-3056			18-3572					
V-200 DFI (3.0L)	T590000	B504988	18-3056			18-3572					
V-200 DFI (3.0L)	B504989	& Sup	18-3056			18-3572					18-3407
200 4-TIEMPOS VERADO (4cil)	B517159	& Sup	18-3056			18-3572				18-3406	18-3407
200 4-TIEMPOS 4.8 INCH TORPEDO	T980000	& Sup	18-3056			18-3572				18-3406	18-3407
V 220 LASER	B117316	& Sup	18-3017	18-3117	18-3114	18-3116	18-3419	18-3217			18-3517
V-225 (2.4L) 8	5628028	& Sup	18-3017								
V-225 (2.4L) 7	5628028	& Sup	18-3017								
V-225 (3.0L) CARB & EFI	D280813	G760299	18-3056								
V-225 (3.0L) CARB & EFI	G760300	T408999	18-3056			18-3571					
V-225 (3.0L) EFI	T409000	B504988	18-3056			18-3571					
V-225 DFI	G590000	T598999	18-3056			18-3571					
V-225 DFI	T599000	B504988	18-3056			18-3571					
V-225 DFI	B504989	& Sup	18-3056			18-3571					18-3407
V-225 Pro XS	B104549	B752546	18-3056			18-3571					
V-225 Pro XS	B752547	& Sup	18-3056			18-3571					18-3407
225 4-tiempos VERADO 4.8 INCH TORPEDO	T980000	& Sup	18-3056			18-3572					18-3407
V-250 (3.0L) EFI	G129222	T408999	18-3056			18-3571					
V-250 (3.0L) EFI	T409000	B504988	18-3056			18-3572					
V-250 DFI	B528615	& Sup	18-3056			18-3572					18-3407
V-250 Pro XS	B426561	B752546	18-3056			18-3571					
V-250 Pro XS	B752547	& Sup	18-3056			18-3572					18-3407
250 4-tiempos VERADO 4.8 INCH TORPEDO	T980000	& Sup	18-3056			18-3572					18-3407
275 4-tiempos VERADO 4.8 INCH TORPEDO	T980000	& Sup	18-3056			18-3572					18-3407
300 4-tiempos VERADO 4.8 INCH TORPEDO	B517434	& Sup	18-3056			18-3572					18-3407
MARK 5	574128	786612	18-3012								
MARK 6, 6A	888005	& Sup	18-3012								
MARK 50	Todos	& Sup	18-3007								
MARK 55	831021	& Sup	18-3007								
MARK 55A	1227131	& Sup	18-3007								
MARK 58 E, MARK 58A (M&E)	1139538	& Sup	18-3007								
9	OG129222	& Sup	18-3056	18-3117	18-3114	18-3116	18-3419	18-3214			18-3517
XR4/Magnum II	Todos		18-3017					18-3217			

- 1 Modelos con alojamiento sup. bomba aluminio
- 2 Modelos con bomba agua aluminio
- 3 Modelos con alojamiento bomba agua plástico
- 4 Modelos con bomba agua plástico
- 5 Bomba tornillos sin aislador
- 6 Bomba tornillos con aislador
- 7 Modelos con tuerca retenedor

- 8 Modelos sin tuerca retenedor
- 9 Modelos con agujero enjuage
- 10 Modelos sin agujero enjuagee
- 11 Modelos con alojamiento superior plástico
- 12 Unidades cambio bomba usando 46-46893A 6 se debe usar 2193818-2529894
- 13 Unidades cambio bomba usando 46-46893A 6 se debe usa USA 3795658-4126549
- 14 Unidades cambio bomba usando 46-46893A 6 se debe usa "Early Mariner Impellers"

TODOS LOS PISTONES SE SUMINISTRAN CON LOS AROS, LOS PASADORES Y LAS ARANDELAS



MARINER (MODELOS JAPONESES)

Contenido de los kits de pistones (Ver tabla de aplicaciones por aplicaciones específicas)

Modelo / HP	Cil.	Medida	Pistón	OEM ref #	Aro	OEM ref #
9.9 / 15	2	std	18-4135	761-7982M, 761-7982T, 761-7134M, 761-7133M, 761-7131M	18-3976	39-15320M, 39-15320T
48	2	std	18-4138	761-8484M, 761-7198M, 761-7197M, 761-7196M	—	—

APLICACIONES AROS Y PISTONES MARINER - MODELOS JAPONESES

Modelo	Ser#	Codigo	Ser #	Pistón standard	.25mm Pistón	.50mm Pistón	Aros standard	.25mm Aros	.50mm Aros	Cant. Requer
9.9	682		ALL	18-4135	—	—	18-3976	—	—	2
15C	684		ALL	18-4135	—	—	18-3976	—	—	2
30A	689		ALL	18-4138	—	—	—	—	—	2

MERCURY / MARINER

Contenido de los kits de pistones SIERRA (Ver tablas de aplicaciones para aplicaciones específicas)

Modelo / HP	Cil.	Medida	Piston	OEM ref #	Aro	OEM Part #	Arandela	OEM ref#
2 AROS PISTÓN - CÚPULA ALTA								
35-140	2-6	2.875 / Std.	—	774-9137A12	18-3918	39-817096A6	18-4294 ④	40-52035
35-140	2-6	2.890 / .015	—	774-9137A13	18-3919	39-817096A16	18-4294 ④	40-52035
35-140	2-6	2.905 / .030	—	774-9137A14	18-3920	39-817096A26	18-4294 ④	40-52035
2 AROS PISTÓN - CÚPULA BAJA								
35-140	2-6	2.875 / Std.	—	774-9137A9	18-3918	39-817096A6	18-4294 ④	40-52035
35-140	2-6	2.890 / .015	—	774-9137A10	18-3919	39-817096A16	18-4294 ④	40-52035
35-140	2-6	2.905 / .030	—	774-9137A11	18-3920	39-817096A26	18-4294 ④	40-52035
3 AROS PISTÓN - CÚPULA ALTA								
35-140	2-6	2.875 / Std.	—	776-8896A3	① 18-3902	39-78816A12, 39-45155A12	18-4294 ④	40-52035
35-140	2-6	2.890 / .015	—	776-8897A2	18-3916	39-78811A12, 39-45204A12	18-4294 ④	40-52035
35-140	2-6	2.905 / .030	—	776-8898A2	① 18-3917	39-88392A12, 39-88392	18-4294 ④	40-52035
3 AROS PISTÓN - CÚPULA BAJA								
35-140	2-6	2.875 / Std.	—	776-8600A9	② 18-3902	39-78816A12	18-4294 ④	40-52035
35-140	2-6	2.890 / .015	—	776-9095A1	② 18-3916	39-78811A12, 39-45204A12	18-4294 ④	40-52035
35-140	2-6	2.905 / .030	—	776-9096A1	18-3917	39-88392A12, 39-88392	18-4294 ④	40-52035
2 AROS PISTÓN - FLUJO CRUZADO								
40-50	4	2.565 / Std.	18-4620	780-9229A7, 743-5172A6, 743-3193A4, 743-3193A2	18-3966	39-18653A12	18-4294 ④	40-52035
40-50	4	2.580 / .015	18-4621	780-9229A10, 743-3366A2, 743-3366A1	18-3967	39-18653A1	18-4294 ④	40-52035
40-50	4	2.595 / .030	18-4622	780-9229A11, 743-7716A2	18-3968	39-18653A2	18-4294 ④	40-52035
50-60	3	2.875 / Std.	—	783-9613A1	18-4019	39-19721A6	18-4294 ④	40-52035
50-60	3	2.890 / .015	18-4017	783-9613A2, 783-9613T2	—	39-19721A1	18-4294 ④	40-52035
50-60	3	2.905 / .030	18-4018	783-9613A3, 783-9613T3	—	39-19721A2	18-4294 ④	40-52035
70-115	3-4	3.375 / Std.	18-4623	777-815965T4, 777-815965A4	18-3979	39-96170A12	18-4294 ④	40-52035
70-115	3-4	3.390 / .015	18-4624	777-815965A5	—	39-96170A3	18-4294 ④	40-52035
70-115	3-4	3.405 / .030	18-4625	777-815965A6	—	39-96170A4	18-4294 ④	40-52035
75-125	3-4	3.500 / Std.	18-4626	2704-826191T4, 2704-826191A4, 2704-826191A6, 2704-821896A6, 2704-812896A2	18-3982	39-822321A12, 39-824905A12	18-4294 ④	40-52035
75-125	3-4	3.515 / .015	18-4627	2704-821896A3	—	39-822321A1	18-4294 ④	40-52035
75-125	3-4	3.530 / .030	18-4628	2704-821896A4	—	39-822321A2	18-4294 ④	40-52035

APLICACIONES PISTÓN DE 3 AROS EN LÍNEA (SÓLO PARA REFERENCIA ③)

HP	Cil.	Desde nº serie.	Hasta nº serie.	Std. Cil. Dia. (medida)	Std. Pistón	.015 O.S. Pistón	.030 O.S. Pistón	Std. aros	.015 O.S. aros	.030 O.S. aros
3.5	1	6202173	& Sup	2	—	—	—	—	—	—
3.6	1	5404657	& Sup	2	—	—	—	—	—	—
3.9	1	1655013	2498135	2	—	—	—	—	—	—

LAS APLICACIONES CONTINÚAN EN LA PÁGINA SIGUIENTE

- ① 3 aros altos NLA, ahora substituidos por aros de pistón ② 3 aros inf. NLA, ahora substituidos por 2 aros pistón
 ③ La tabla es sólo para referencia, los pistones recibidos serán versión 2 aros
 ④ Precio por pieza. Para pedir envasado añadir -9 a la referencia..

APLICACIONES PISTÓN DE 3 AROS EN LÍNEA (SÓLO PARA REFERENCIA ③)

HP	Cil.	Desde nº serie.	Hasta nº serie.	Std. Cil. Dia. (medida)	Std. Pistón	.015 O.S. Pistón	.030 O.S. Pistón	Std. aros	.015 O.S. aros	.030 O.S. aros
4 (1Cil)	1	2498136	A809600	2	—	—	—	—	—	—
4.5	1	4107220	& Sup	2	—	—	—	—	—	—
7.5	2	2529895	& Sup	2	—	—	—	—	—	—
9.8	2	1470349	& Sup	2	—	—	—	—	—	—
20	2	1922910	5942040	2.562	—	—	—	—	—	—
25	2	1467499	149931	2.562	—	—	—	—	—	—
30 Jet (40 HP)	4	0C159200	& Sup	2.562	18-4620	18-4621	18-4622	18-3966	18-3967	18-3968
30 Jet (40 HP)		0C159200	& Sup	2.562	18-4620	18-4621	18-4622	18-3966	18-3967	18-3968
35	2	6445653	& Sup	2.875	—	—	—	18-3918	18-3916	18-3920
40 (4 cil)	4	1279085	1476509	2.562	—	—	—	—	—	—
40	2	2045260	C159199	2.875	—	—	—	18-3918	18-3916	18-3920
40, 402	2	3336258	6445652	2.875	—	—	—	18-3918	18-3916	18-3920
40	4	0C159200	& Sup	2.562	18-4620	18-4621	18-4622	18-3966	18-3967	18-3968
45	4	1476510	& Sup	2.562	18-4620	18-4621	18-4622	18-3966	18-3967	18-3968
45	4	5531630	0B110788	2.562	18-4620	18-4621	18-4622	18-3966	18-3967	18-3968
45	4	0B110789	& Sup	2.562	18-4620	18-4621	18-4622	18-3966	18-3967	18-3968
45 JET	3	D000750	G589999	2.955	—	18-4017	18-4018	18-4019	—	—
50,500	4	2116318	6428680	2.562	18-4620	18-4621	18-4622	18-3966	18-3967	18-3968
50	3	6428681	B122929	2.875	18-4500	—	—	18-3918	18-3916	18-3920
50	3	B122930	D000749	2.875	18-4500	—	—	18-3918	18-3916	18-3920
50	3	D000750	G589999	2.955	—	18-4017	18-4018	18-4019	—	—
55	3	6428681	0B122929	2.875	18-4500	—	—	18-3918	18-3916	18-3920
55	3	B122930	D000749	2.875	18-4500	—	—	18-3918	18-3916	18-3920
55	3	D000750	G589999	2.955	—	18-4017	18-4018	18-4019	—	—
60	6	1303411	1542744	2.562	—	—	—	—	—	—
60	3	6428681	B122929	2.875	—	—	—	18-3918	18-3916	18-3920
60	3	B122930	D000749	2.875	—	—	—	18-3918	18-3916	18-3920
60	3	D000750	G589999	2.955	—	18-4017	18-4018	18-4019	—	—
65,650	3	3293184	4382056	2.875	—	—	—	18-3918	18-3916	18-3920
65,650	3	4382057	4571651	2.875	—	—	—	18-3918	18-3916	18-3920
70	3	4571652	A996141	2.875	—	—	—	18-3918	18-3916	18-3920
70 (3 cil.) w/Rod #646-8188461	3	A996142	& Sup	3.375	18-4623	18-4624	18-4625	18-3979	—	—
75	4	6432901	& Sup	2.875	—	—	—	18-3918	18-3916	18-3920
75 (3 cil.) w/Rod #646-818846	3	C222000	D283221	3.375	18-4623	18-4624	18-4625	18-3979	—	—
75 (3 cil.)	3	D283222	& Sup	3.5	18-4626	18-4627	18-4628	18-3982	—	—
80,800	4	2559001	3493912	2.875	—	—	—	18-3918	18-3916	18-3920
80,800	4	4831999	6432900	2.875	—	—	—	18-3918	18-3916	18-3920
80 Jet	3	D283222	& Sup	3.5	18-4626	18-4627	18-4628	18-3982	—	—
85,850	4	3493913	4831998	2.875	—	—	—	18-3918	18-3916	18-3920
85,850	4	4366802	4831998	2.875	—	—	—	18-3918	18-3916	18-3920
85 Mar.	4	4731898	4842728	2.875	—	—	—	18-3918	18-3916	18-3920
90,900	6	4845301	& Sup	2.875	—	—	—	18-3918	18-3916	18-3920
90 (3 cil.) w/Rod #646-818846	3	A9964142	D283221	3.375	18-4623	18-4624	18-4625	18-3979	—	—
90 (3 cil.)	3	D283222	& Sup	3.5	18-4626	18-4627	18-4628	18-3982	—	—
95	6	1869776	2318585	2.875	—	—	—	18-3918	18-3916	18-3920
100 SS	6	2318586	2836018	2.875	—	—	—	18-3918	18-3916	18-3920
100 BP	6	2399698	3253111	2.875	—	—	—	18-3918	18-3916	18-3920
100 (4 cil.) w/Rod #646-818846	4	B209468	D283221	3.375	18-4623	18-4624	18-4625	18-3979	—	—
100 (4cil)	4	D283222	& Sup	3.5	18-4626	18-4627	18-4628	18-3982	—	—
115 1150	6	2836019	5829643	2.875	—	—	—	18-3918	18-3916	18-3920
115 Merc.	6	5829644	B209467	2.875	18-4500	—	—	18-3918	18-3916	18-3920
115 Mar.	6	5738891	5861526	2.875	—	—	—	18-3918	18-3916	18-3920
115 Mar.	6	5861527	C100000	2.875	18-4500	—	—	18-3918	18-3916	18-3920
115 (4 cil.) w/Rod #646-818846	4	C100000	D283221	3.375	18-4623	18-4624	18-4625	18-3979	—	—
115 (4cil)	4	D283222	& Sup	3.5	18-4626	18-4627	18-4628	18-3982	—	—

APLICACIONES CONINUAN EN LA SIGUIENTE PÁGINA

APLICACIONES PISTÓN DE 3 AROS EN LÍNEA (SÓLO PARA REFERENCIA ③)

HP	Cil.	Desde nº serie.	Hasta nº serie.	Std. Cil. Dia. (medida)	Std. Pistón	.015 O.S. Pistón	.030 O.S. Pistón	Std. aros	.015 O.S. aros	.030 O.S. aros
125 BP	6	2641855	3253111	2.875	—	—	—	18-3918	18-3916	18-3920
135	6	2839369	3293233	2.875	—	—	—	18-3918	18-3916	18-3920
140 1400	6	3293234	3502805	2.875	—	—	—	18-3918	18-3916	18-3920
140 1400	6	4865678	& SUP	2.875	18-4500	—	—	18-3918	18-3916	18-3920
150 1500	6	3502806	5327622	2.875	18-4500	—	—	18-3918	18-3916	18-3920

③ La tabla es sólo para referencia, los pistones recibidos serán versión 2 aros.

PISTONES DE 2 AROS EN LÍNEA & APLICACIONES DE AROS

HP	Cil.	Desde nº Serie	Hasta nº Serie	Dia. (medida)	Pistones		babor		babor		Piston Aros		
					Std. (babor)	Stbd.	.015" O.S.	Stbd.	.030 O.S.	Stbd.	Std.	.015" O.S.	.030 O.S.
105 JET	V-6	D082000	& Sup	3.125	—	—	—	18-4013	—	—	18-3921	18-3922	18-3923
V-135	V-6	A904646	C239552	3.125	—	—	—	—	—	—	18-3921	18-3922	18-3923
V-135 (w/ rod 644-8141)	V-6	C239553	G960499	3.125	—	—	—	18-4013	—	—	18-3921	18-3922	18-3923
V-135 (2.5L) (w/o rod 636-818141)	V-6	C239553	G960499	3.125	—	—	—	—	—	—	18-3921	18-3922	18-3923
V-140 JET	V-6	D082000	G960499	3.5	18-4635	18-4636	18-4637	18-4638	NA	NA	18-3982	—	—
V-140 JET	V-6	G960500	Sup	3.5	18-4635	18-4636	18-4637	18-4638	NA	NA	18-3982	—	—
V-150 MAR	V-6	5600162	6038680	3.125	—	—	—	—	—	—	18-3921	18-3922	18-3923
V-150 MAR	V-6	6038681	C239552	3.125	—	—	—	—	—	—	18-3921	18-3922	18-3923
V-150, 1,501,500	V-6	4868998	6042945	3.125	—	—	—	—	—	—	18-3921	18-3922	18-3923
V-150	V-6	6042946	C239552	3.125	—	—	—	—	—	—	18-3921	18-3922	18-3923
V-150 (w/ rod 644-8141)	V-6	C239553	G960499	3.125	—	—	—	18-4013	—	—	18-3921	18-3922	18-3923
V-150 (2.5L) (w/o rod 636-818141)	V-6	C239553	G960499	3.125	—	—	—	—	—	—	18-3921	18-3922	18-3923
V-150 EFI XR6 MAGIII	V-6	D082000	G960499	3.5	18-4635	18-4636	18-4637	18-4638	NA	NA	18-3982	—	—
V-150 XR4 MAGIII	V-6	B242885	C239552	3.375	—	—	—	18-4570	—	—	18-3924	18-3925	—
V-150 XR4 MAGIII	V-6	C239553	D081999	3.375	—	—	—	—	—	—	18-3924	18-3925	—
V-175, 175, 1750	V-6	4301235	6618750	3.125	—	—	—	—	—	—	18-3921	18-3922	18-3923
V-175	V-6	6618751	C239552	3.375	—	—	—	—	—	—	18-3927 ④	—	—
V-175	V-6	C239553	D081999	3.375	—	—	—	—	—	—	18-3924	18-3925	—
V-175	V-6	D082000	G960499	3.5	18-4635	18-4636	18-4637	18-4638	NA	NA	18-3982	—	—
V-175	V-6	G960500	& Sup	3.5	18-4635	18-4636	18-4637	18-4638	NA	NA	18-3982	—	—
V-175 I XRI EF	V-6	D000750	D081999	3.5	18-4635	18-4636	18-4637	18-4638	NA	NA	18-3982	—	—
V-175	V-6	D000750	D081999	3.5	18-4635	18-4636	18-4637	18-4638	NA	NA	18-3982	—	—
V-175 XRI EFI	V-6	D082000	G303045	3.5	18-4635	18-4636	18-4637	18-4638	NA	NA	18-3982	—	—
V-175 XRI EFI	V-6	G303046	& Sup	3.5	18-4635	18-4636	18-4637	18-4638	NA	NA	18-3982	—	—
V-200, 2,002,000	V-6	4839034	6203990	3.375	—	—	—	—	—	—	18-3927 ④	—	—
V-200 (2.4L)	V-6	6203991	C291519	3.375	—	—	—	—	—	—	18-3927 ④	—	—
V-200 (2.5L) (w/ rod #644-818141)	V-6	C291520	D081999	3.5	18-4635	18-4636	18-4637	18-4638	NA	NA	18-3982	—	—
V-200 (2.5L)	V-6	D082000	& Sup	3.5	18-4635	18-4636	18-4637	18-4638	NA	NA	18-3982	—	—
V-200 XRI EFI	V-6	C100861	C291519	3.375	—	—	—	—	—	—	18-3927 ④	—	—
V-200	V-6	C291520	G960499	3.5	18-4635	18-4636	18-4637	18-4638	NA	NA	18-3982	—	—
XRI EFI													
V-220	V-6	B117316	Sup	3.375	—	—	—	—	—	—	18-3927 ④	—	—
V-225	V-6	5628028	D280812	3.375	—	—	—	—	—	—	18-3927 ④	—	—
V-225 (3.0L)	V-6	D280813	Sup	3.625	—	—	—	—	—	—	18-4050	—	—

SIERRA V-6 CONTENIDO KIT PISTÓN (VER TABLA PARA APLICACIONES ESPECIFICAS)

Model / HP	Cil.	Medida	Pistón	OEM port #	Aro pistón	OEM Part #	Pasador	Circlicps
135, 150 2 Litros	V-6	3.125 / Std. (babor)	—	765-7442T32	18-3921	39-93481A12	—	N.S.S.
135, 150 2 Litros	V-6	3.125 / Std. (estribor)	—	765-7441T32	18-3921	39-93481A12	—	N.S.S.
135, 150 2 Litros	V-6	3.140 / .015 (babor)	—	765-7444A11	18-3922	39-78918A4	—	N.S.S.
135, 150 2 Litros	V-6	3.140 / .015 (estribor)	18-4013	765-7443A11	18-3922	39-78918A4	—	N.S.S.
135, 150 2 Litros	V-6	3.155 / .030 (babor)	—	765-7446A11	18-3923	39-85636A4	—	N.S.S.

4 de — = 1 de 39-21665A12	3 de 18-3919 = 1 de 39-817096A16	6 de 18-3924 = 1 de 39-18487A12	3 de 18-4019 = 1 de 39-19721A6
4 de 18-3902 = 1 de 39-78816A12	3 de 18-3920 = 1 de 39-817096A26	2 de 18-3925 = 1 de 39-815267A4	6 de 18-3982 = 1 de 39-822321A12
4 de 18-3916 = 1 de 39-78811A12	6 de 18-3921 = 1 de 39-93481A12	6 de 18-3966 = 1 de 39-18653A12	6 de 18-4050 = 1 de 39-827179A12
4 de 18-3917 = 1 de 39-88392A12	2 de 18-3922 = 1 de 39-78918A4	6 de 18-3968 = 1 de 39-18653A2	6 de 18-3927 = 1 de 39-813011A12
3 de 18-3918 = 1 de 39-817096A6	2 de 18-3923 = 1 de 39-85636A4	6 de 18-3967 = 1 de 39-18653A1	

APLICACIONES CONTINUAN EN LA SIGUIENTE PÁGINA

SIERRA V-6 CONTENIDO KIT PISTÓN (VER TABLA PARA APLICACIONES ESPECIFICAS)

Model / HP	Cil.	Medida	Pistón	OEM port #	Aro pistón	OEM Part #	Pasador	Circlips
135, 150 2 Litros	V-6	3.155 / .030 (stbd)	—	765-7445T11	18-3923	39-85636A4	—	N.S.S.
135-175	V-6	3.125 / Std. (babor)	—	765-7442A3, A36	18-3921	39-93481A12	—	N.S.S.
135-175	V-6	3.125 / Std. (stbd)	18-4545	765-7441A3, A36	18-3921	39-93481A12	—	N.S.S.
135-175	V-6	3.140 / .015 (babor)	—	765-7442A2, A12	18-3922	39-78918A4	—	N.S.S.
135-175	V-6	3.140 / .015 (stbd)	—	765-7443A2, A12	18-3922	39-78918A4	—	N.S.S.
135-175	V-6	3.155 / .030 (babor)	—	N/A	18-3923 ④	39-85636A4	—	N.S.S.
135-175	V-6	3.155 / .030 (stbd)	—	N/A	18-3923 ④	39-85636A4	—	N.S.S.
175-225	V-6	3.375 / Std. (babor)	—	766-8667A41/ T41	18-3927 ④	39-813011A12	—	N.S.S.
175-225	V-6	3.375 / Std. (stbd)	—	766-8666A41/ T41	18-3927 ④	39-813011A12	—	N.S.S.
175-225	V-6	3.390 / .015 (babor)	—	766-8667A36/ A43	18-3925	39-815267A4	—	N.S.S.
175-225	V-6	3.390 / .015 (stbd)	—	766-8666A36/ A43	18-3925	39-815267A4	—	N.S.S.
175-225	V-6	3.405 / .030 (babor)	—	NLA	—	NLA	—	N.S.S.
150 XR4/MAG II	V-6	3.375 / Std. (babor)	—	766-8667A42/ T42	18-3924	39-18487A12	—	N.S.S.
150 XR4/MAG II	V-6	3.375 / Std. (stbd)	—	766-8666A42/ T42	18-3924	39-18487A12	—	N.S.S.
150 XR4/MAG II	V-6	3.390 / .015 (babor)	—	766-8667A36/ A43	18-3925	39-815267A4	—	N.S.S.
150 XR4/MAG II	V-6	3.390 / .015 (stbd)	—	766-8666A36/ A43	18-3925	39-815267A4	—	N.S.S.
150 XR4/MAG II	V-6	3.405 / .030 (babor)	—	NLA	—	NLA	—	N.S.S.
140-200, XR6/MAG III	V-6	3.500 / Std. (babor)	18-4635	785-9737T9	18-3982	39-822321A12	—	N.S.S.
140-200, XR6/MAG III	V-6	3.500 / Std. (stbd)	18-4636	785-9738T9	18-3982	39-822321A12	—	N.S.S.
140-200, XR6/MAG III	V-6	3.515 / .015 (babor)	18-4637	785-9737A10	—	39-822321A1	—	N.S.S.
140-200, XR6/MAG III	V-6	3.515 / .015 (stbd)	18-4638	785-9738T10	—	39-822321A1	—	N.S.S.
225 (3.0L)	V-6	3.6265 / Std. (babor)	—	700-858294T1	18-4050	39-827179A12	—	N.S.S.
225 (3.0L)	V-6	3.6265 / Std. (stbd)	—	700-858295T1	18-4050	39-827179A12	—	N.S.S.
225 (3.0L)	V-6	3.6415 / .015 (babor)	—	700-878571A2	—	39-826293A12	—	N.S.S.
225 (3.0L)	V-6	3.6415 / .015 (stbd)	—	700-878572A2	—	39-826293A12	—	N.S.S.
225 (3.0L)	V-6	3.6565 / .030 (babor)	—	700-878573A2	—	39-826297A12	—	N.S.S.
225 (3.0L)	V-6	3.6565 / .030 (stbd)	—	700-878574A2	—	39-826297A12	—	N.S.S.

4 de — = 1 of 39-21665A12
 4 de 18-3902 = 1 de 39-78816A12
 4 de 18-3916 = 1 de 39-78811A12
 4 de 18-3917 = 1 de 39-88392A12
 3 de 18-3918 = 1 de 39-817096A6

3 de 18-3919 = 1 de 39-817096A16
 3 de 18-3920 = 1 de 39-817096A26
 6 de 18-3921 = 1 de 39-93481A12
 2 de 18-3922 = 1 de 39-78918A4
 2 de 18-3923 = 1 de 39-85636A4

6 de 18-3924 = 1 de 39-18487A12
 2 de 18-3925 = 1 de 39-815267A4
 6 de 18-3966 = 1 de 39-18653A12
 6 de 18-3968 = 1 de 39-18653A2
 6 de 18-3967 = 1 de 39-18653A1

3 de 18-4019 = 1 de 39-19721A6
 6 de 18-3982 = 1 de 39-822321A12
 6 de 18-4050 = 1 de 39-827179A12
 6 de 18-3927 = 1 de 39-813011A12

④ Para bloques cromados

<p>Env. de 200</p>  <p>AGUJAS COJINETE</p> <table border="1"> <thead> <tr> <th>Ref #</th> <th>Reemplaza:</th> <th>Descripción</th> </tr> </thead> <tbody> <tr> <td>18-4036 ①</td> <td>29-47270</td> <td>Pistón</td> </tr> <tr> <td>18-4037 ①</td> <td>29-71422</td> <td>Cojinete central</td> </tr> </tbody> </table>	Ref #	Reemplaza:	Descripción	18-4036 ①	29-47270	Pistón	18-4037 ①	29-71422	Cojinete central	<p>AGUJAS COJINETE</p>  <table border="1"> <thead> <tr> <th>Ref #</th> <th>Reemplaza</th> <th>Descripción</th> </tr> </thead> <tbody> <tr> <td>18-4038</td> <td>31-62596A1, 31-63075A1, 31-61424A2, 31-58859A1, 31-55332A1, 31-47245A1</td> <td>Cigüeñal sin jaula</td> </tr> <tr> <td>18-4039</td> <td>31-17514A2, 31-8M0045430</td> <td>Cigüeñal sin jaula</td> </tr> </tbody> </table> <p>16 agujas-se debe reutilizar la jaula</p>	Ref #	Reemplaza	Descripción	18-4038	31-62596A1, 31-63075A1, 31-61424A2, 31-58859A1, 31-55332A1, 31-47245A1	Cigüeñal sin jaula	18-4039	31-17514A2, 31-8M0045430	Cigüeñal sin jaula	 <p>18-1186 COJINETE AGUJAS CON RETENEDORES Reemplaza: 29-88258 + 12-88263 (2 piezas) Para: Merc V-6 200/225/250 HP 3.0 & 3.4L</p>
Ref #	Reemplaza:	Descripción																		
18-4036 ①	29-47270	Pistón																		
18-4037 ①	29-71422	Cojinete central																		
Ref #	Reemplaza	Descripción																		
18-4038	31-62596A1, 31-63075A1, 31-61424A2, 31-58859A1, 31-55332A1, 31-47245A1	Cigüeñal sin jaula																		
18-4039	31-17514A2, 31-8M0045430	Cigüeñal sin jaula																		
<p>18-1194 COJINETE Reemplaza: 31-17514A1, 8M004528, 31-17514A2, 31-8M0045428, 31-17514, 31-67526A1, 31-67526A2, 31-67526, 31-821146A1, 31-814337A1, 879366 Para: 30-60HP 2&3 Cil., Mag II, V-135-200 & XR4</p> 	<p>18-1153 COJINETE BOLA Reemplaza: 30-63326, 30-63326T, 30-49313, 30-54215, 30-20464</p> 	<p>18-1154 COJINETE BOLA Reemplaza: 30-63742</p> 																		
<p>18-1196 COJINETE Reemplaza: 31-74248T, 31-74248 Para: V135, 150, 175, 200 (carb)</p> 	<p>18-1345 COJINETE BOLA Reemplaza: 30-67923T, 30-67923, 30-41421 Para: 135-225 HP V-6</p> 																			

① Precio por pieza. Para pedir envasado añadir -9 a la referencia.

18-1346

COJINETE BOLA

Reemplaza: 30-43011T, 30-43011
Para: 75-125 3 & 4 cil.



18-1398

COJINETE BOLA

Reemplaza: 30-72961, 30-20861
Para: 3.5-9.8 HP & Mercruiser
Bomba de agua con correa



HP	Cil.	Desde nº de serie.	Hasta nº de serie	std.cil. diámetro	Rodillos	cojinete central	cojinete pistón	cojinete principal inferior	Aro inferior	Retén aceite inferior	Retén aceite inferior 2	Aro superior	Cojinete principal superior	Retén aceite superior	cojinete superior
3.5		6202173	& Sup	—	—	—	—	—	—	—	—	18-7152	18-1398	—	—
3.6		5404657	& Sup	—	—	—	—	18-1398	—	—	—	18-7152	18-1398	—	—
3.9	1	1655013	2498135	—	—	—	—	18-1398	—	—	—	18-7152	18-1398	—	—
4 (40)	1	2498136	4107219	—	—	—	—	18-1398	—	—	—	18-7152	18-1398	—	—
4	1	5595532	& Sup	—	—	—	—	18-1398	—	—	—	18-7152	18-1398	—	—
4 (40)	2	5589202	& Sup	—	—	—	—	18-1398	18-7102	—	—	—	—	18-0515	—
4.5 (4.5, 45)	1	4107220	& Sup	—	—	—	—	18-1398	—	—	—	18-7152	18-1398	—	—
4.5	1	5595532	& Sup	—	—	—	—	18-1398	—	—	—	18-7152	18-1398	—	—
6 (60)		1916139	2529894	—	—	—	—	18-1398	—	—	—	18-7459	18-1398	—	—
6		A197112	T800749	—	—	—	—	—	—	—	—	—	—	—	—
7.5 (75)		2529895	5226934	—	—	—	—	18-1398	—	—	—	18-7152	18-1398	—	—
10 (100)		1290910	& Sup	—	—	—	—	—	—	—	—	—	—	—	—
10 (MARATHON, XR10, SEAPRO)		D038000	& Sup	—	—	—	—	—	—	—	—	—	—	—	—
15 (150)		1290910	1499331	—	—	—	—	—	—	18-2026	18-2026	—	18-1153	—	—
15		B292414	& Sup	—	—	—	—	—	—	—	—	—	—	—	—
15 (EXPORT SEAPRO)		G044365	G202749	—	—	—	—	—	—	18-0537	—	—	—	—	—
15 (SEAPRO)		G438000	& Sup	—	—	—	—	—	—	—	—	—	—	—	—
15 (SUPER)		B238464	G202749	—	—	—	—	—	—	18-0537	—	—	—	—	—
18		5837437	6239752	—	—	—	—	—	—	18-0537	—	—	—	—	—
20		1558310	2296266	—	—	—	—	—	—	18-2026	18-2026	—	18-1153	—	—
20 (200, 20)		2296267	& Sup	—	—	—	—	—	—	—	—	—	—	—	—
25 (KF 9)	4	377150	495761	—	—	—	—	—	—	—	—	—	—	—	—
10 (MK10)	2	1057994	1122327	—	—	—	—	—	—	—	—	—	—	—	—
15 (MK15)	2	1200114	1287384	—	—	—	—	—	—	—	—	—	—	—	—
16 (MK20)	2		Todos	—	—	—	—	—	—	—	—	—	—	—	—
20 (MK25)	2	860979	& Sup	—	—	—	—	—	—	—	—	—	—	—	—
22 (MK28)	2	1158546	1238089	—	—	—	—	—	—	—	—	—	—	—	—
30 (MK30)	4		Todos	—	—	—	—	—	—	—	—	—	—	—	—
35 (MK35)	4	1217222	1271884	—	—	—	—	—	—	—	—	—	—	—	—
25 (MK40)	4	711400	& Sup	—	—	—	—	—	—	—	—	—	—	—	—
40 (MK50)	4		Todos	—	—	—	—	—	—	—	—	—	—	—	—
40(MK55)	4	831021	& Sup	—	—	—	—	—	—	—	—	—	—	—	—
45 (MK58)	4	1139538	& Sup	—	—	—	—	—	—	—	—	—	—	—	—
60 (MK75)	6		Todos	18-4037	—	—	—	—	—	—	—	—	—	—	—
70 (MK78)	6	1143038	& Sup	18-4037	—	—	—	—	—	—	—	—	—	—	—
3.5 / 3.6 / 3.9	1		Todos	—	—	—	—	18-1398	—	—	—	—	18-1398	—	—
9.8	2	1865779	& Sup	—	—	—	—	18-1398	—	—	—	—	18-1398	—	—
20	2	1292910	6443972	—	—	—	—	18-1153	—	—	—	—	18-1153	—	—
20 (20 XD)	2	6443973	B114230	—	—	—	—	—	—	18-0537	—	—	—	—	—
25	2	1467499	1499331	—	—	—	—	—	—	—	—	—	—	—	—
25	2	5705532	6241936	—	—	—	—	—	—	18-0537	—	—	—	—	—
25 (250)		1290910	1499331	—	—	—	—	—	—	—	—	—	—	—	—
30 (300)	4	1271885	1448139	—	—	—	—	18-1154	18-7151	—	18-2016	18-7151	18-1154	—	—
30 (644cc)	2	G053314	D589999	—	18-4039	—	18-4036	18-1154	18-7176	18-2016	—	—	—	—	—
30 (644cc)	2	G590000	T598999	—	18-1194	—	18-4036	—	—	—	—	—	—	—	—
30 JET	4	C159200	& Sup	18-4037	—	—	—	18-1154	—	—	—	—	18-1154	—	—

APLICACIÓN CONTINÚAN EN LA SIGUIENTE PÁGINA

HP	Cil.	Desde nº de serie.	Hasta nº de serie	std.cil. diámetro	Rodillos	cojinete central	cojinete pistón	cojinete principal inferior	Aro inferior	Retén aceite inferior	Retén aceite inferior 2	Aro superior	Cojinete principal superior	Retén aceite superior	cojinete superior
30 JET	3	G590000	& Sup	—	—	—	18-4036	18-1154	—	—	—	—	—	—	—
35 (350, 35A)	4	121722	1448139	—	—	—	—	18-1154	—	—	—	—	18-1154	—	—
35 (350)	2	1571114	1898815	—	—	—	—	18-1154	18-7151	—	—	—	18-1154	—	—
35	2	6445653	B110788	—	18-4038	—	18-4036	18-1154	—	—	—	—	—	—	—
40 (400E, 400M)	4	1279685	1367697	—	—	—	—	18-1154	—	—	—	—	18-1154	—	—
40 (400E, 400M)	4	1384806	1476509	—	—	—	—	—	—	—	—	—	—	—	—
40 (400)	2	2874704	3045259	—	18-4038	—	18-4036	18-1154	18-2016	18-2016	—	—	18-2016	—	—
40 (400)	2	3045260	3336257	—	18-4038	—	18-4036	—	—	—	—	—	—	—	—
40 (402)		3336258	4117709	—	18-4038	—	18-4036	—	—	—	—	—	—	—	—
40 (402, 40)		4117710	5556229	—	18-4038	—	18-4036	—	18-2016	18-2016	—	—	18-2016	—	—
40	2	5556230	6443972	—	18-4038	—	18-4036	—	—	—	—	—	—	—	—
40	2	G053314	& Sup	—	18-1194	—	18-4036	18-1154	18-2016	—	—	—	—	—	—
40	3	G531301	& Sup	—	18-1194	—	18-4036	18-1154	18-2016	—	—	—	—	—	—
40	4	C159200	& Sup	18-4037	—	—	—	18-1154	18-7161	18-2016	—	18-7151	18-1154	—	—
45 (450)	4	1476510	1531568	—	—	—	—	18-1154	—	18-2016	18-7151	18-1154	18-1154	—	—
45	4	5531630	& Sup	18-4037	—	—	—	18-1154	18-7151	18-2016	18-7151	18-1154	18-1154	—	—
45 JET		D000750	D589999	—	18-4039	—	18-4036	18-1154	18-7176	18-2016	—	—	—	18-2016	—
45 JET (59 CID)	3	G590000	& Sup	—	18-1194	—	18-4036	18-1154	18-7176	18-2016	—	—	—	—	—
50 (500)	4	1421113	1755548	—	—	—	—	18-1154	18-7151	—	18-2016	18-7151	18-1154	18-2016	—
50 (500)		1770179	2305100	—	—	—	—	—	—	—	—	—	—	—	—
50 (500, 50)		2305151	5193253	—	—	—	—	—	—	—	—	—	—	—	—
50	4	5193259	5531629	18-4037	—	—	—	18-1154	—	—	—	—	18-1154	—	—
50	4	5531630	& Sup	18-4037	—	—	—	—	—	—	—	—	—	—	—
50	3	6428681	D000749	18-4037	18-4038	—	18-4036	—	18-7161	18-2016	18-2016	18-7415	—	18-2016	—
50	3	D000750	G589999	—	18-4039	—	18-4036	18-1154	18-7176	18-2016	—	—	—	18-2016	—
50	3	G590000	& Sup	—	18-1194	—	18-4036	18-1154	18-7176	18-2016	—	—	—	—	—
55	3	D000750	G589999	—	18-4039	—	18-4036	18-1154	18-7176	18-2016	—	—	—	18-2016	—
55	3	G590000	& Sup	—	18-1194	—	18-4036	18-1154	18-7176	18-2016	—	—	—	—	—
60 (600)	4	1303411	1542744	18-4037	—	—	—	18-1154	18-7151	—	18-2016	18-7151	18-1154	18-2016	—
60	3	6428681	D000749	18-4037	18-4038	—	18-4036	—	18-7161	18-2016	18-2016	18-7415	—	18-2016	—
60	3	D000750	G589999	—	18-4038	—	18-4036	18-1154	18-7176	18-2016	—	—	—	18-2016	—
60 (59 CID)	3	G590000	& Sup	—	18-1194	—	18-4036	18-1154	—	—	—	—	—	—	—
65 (650)	4	1545745	1765043	18-4037	—	—	—	18-1154	18-7151	—	18-2016	—	—	18-2016	—
65 (650)	4	1765044	2119748	18-4037	—	—	—	—	—	—	—	—	—	—	—
65 (650)	4	2119749	2309310	18-4034	—	—	—	—	—	—	—	—	—	—	—
65 (650)	4	2309311	3293183	18-4037	—	—	—	—	—	—	—	—	—	—	—
65 (650)	3	3293184	4571651	18-4037	18-4038	—	18-4036	—	18-7161	18-2016	18-2016	18-7961	—	18-2016	—
65 (650)	3	8006640	8042349	18-4037	18-4038	—	18-4036	—	—	—	—	—	—	—	—
65 (650)	3	9020074	9135824	18-4037	18-4038	—	18-4036	—	—	—	—	—	—	—	—
65 (650)	3	7013633	7087822	18-4037	18-4038	—	18-4036	—	—	—	—	—	—	—	—
65 JET		D283222	& Sup	—	—	—	—	18-1346	—	18-2016	—	18-7414	—	18-0523	—
70 (700)	6	1296411	1566239	18-4037	—	—	—	18-1154	18-7151	—	18-2016	18-7151	18-1154	18-2016	—
70	3	4571652	5579016	18-4037	18-4038	—	18-4036	—	18-7161	18-2016	18-2016	18-7415	—	18-2016	—
70	3	5579017	6428680	18-4037	18-4038	—	18-4036	—	—	—	—	—	—	—	—
70 CONNECTING ROD #638-8532-1	3	A996142	C221999	—	—	—	—	18-1346	—	18-2016	—	18-7414	—	18-0523	—
75	4	6432901	& Sup	18-4037	18-4038	—	18-4036	18-1154	18-7161	18-2016	18-2016	18-7961	—	18-2016	—
75 CONNECTING ROD #638-8532-1	3	C222000	& Sup	—	—	—	—	18-1346	—	18-2016	—	18-7414	—	18-0523	—
75 DFI (1.5L)		T980000	B189548	—	—	—	—	18-1346	—	18-2016	—	—	—	—	—
80 (800)	6	1335465	1566239	18-4037	—	—	—	18-1154	18-7151	—	18-2016	18-7151	18-1154	18-2016	—
80 (800)	4	2559001	2670574	18-4037	18-4038	—	18-4036	18-1154	18-2016	18-2016	18-2016	18-7961	—	18-2016	—
80 (800)	4	2783253	3493912	18-4037	18-4038	—	18-4036	—	—	—	—	—	—	—	—
80 (800, 80)	4	4831999	5582561	18-4037	18-4038	—	18-4036	18-1154	18-7161	18-2016	18-2016	18-7961	—	18-2016	—

APLICACIÓN CONTINÚAN EN LA SIGUIENTE PÁGINA

HP	Cil.	Desde nº de serie.	Hasta nº de serie	std.cil. diámetro	Rodillos	cojinete central	cojinete pistón	cojinete principal inferior	Aro inferior	Retén aceite inferior	Retén aceite inferior 2	Aro superior	Cojinete principal superior	Retén aceite superior	cojinete superior
80 (80)	4	5582562	6422900	18-4037	18-4038	—	18-4036	—	—	—	—	—	—	—	—
80 CONNECTING ROD #638-8532-1	3	A996142	C221999	—	—	—	—	18-1346	—	18-2016	—	18-7414	—	18-0523	—
80 JET		D283222	& Sup	—	—	—	—	18-1346	—	18-2016	—	18-7414	—	18-0523	—
85 (850, 76 CID)	6	1460999	1464848	18-4037	—	—	—	18-1154	18-7151	—	18-2016	18-2016	—	18-2016	—
85 (850, 90 CID)	6	1566240	1766823	18-4037	—	—	—	18-1345	18-2016	—	18-2016	—	—	18-2016	—
85 (850)	4	3493913	3865694	18-4037	18-4038	—	18-4036	18-1154	18-7161	18-2016	18-2016	18-7961	—	18-2016	—
85 (850)	4	3865695	4831998	18-4037	18-4038	—	18-4036	—	—	—	—	—	—	—	—
90 (900)	6	1766824	1850448	18-4037	—	—	—	18-1154	18-2016	—	18-2016	—	—	18-2016	—
90 (900)	6	1850449	1869775	18-4037	—	—	—	—	—	—	—	—	—	—	—
90 (900, 90)	6	4845301	5594656	18-4037	18-4038	—	18-4036	18-1154	18-7161	18-2016	18-2016	—	—	18-2016	—
90 (90)	6	5594657	& Sup	18-4037	18-4038	—	18-4036	—	—	—	—	—	—	—	—
90 (90) CONNECTING ROD #638-8532-1	3	A996142	D283221	—	—	—	—	18-1346	—	18-2016	—	18-7414	—	18-0523	—
95 (950E)	6	1869776	2318585	18-4037	—	—	—	18-1154	18-7151	—	18-2016	—	—	18-2016	—
95 (950E-SS)		1869776	2318585	18-4037	—	—	—	18-1154	18-2016	—	18-2016	—	—	18-2016	—
95 (950E-SS-1)		1869776	2318585	18-4037	—	—	—	—	—	—	—	—	—	—	—
100 (1000)	6	1464949	2318585	18-4037	—	—	—	18-1154	18-7151	—	18-2016	—	—	18-2016	—
100 (1000SS)		2318586	2836018	18-4037	—	—	—	18-1154	18-7151	—	18-2016	—	—	18-2016	—
100 (1000BP)		2399698	2641854	18-4037	—	—	—	—	—	—	—	—	—	—	—
100 (1000BP)		2641855	3253111	18-4037	18-4038	—	18-4036	18-1154	18-7151	18-2016	18-2016	18-7961	—	18-2016	—
100	4	B209468	& Sup	—	—	—	—	18-1346	—	—	—	—	—	—	—
105 JET		D820000	& Sup	—	18-1194	—	—	18-1345	—	—	—	—	—	—	—
110 (1100E)		1870204	2314955	18-4037	—	—	—	18-1154	18-7151	—	18-2016	—	—	18-2016	—
110 (1100-SS)	6	1870204	2314955	18-4037	—	—	—	18-1154	18-2016	—	18-2016	—	—	18-2016	—
110 (1100E-SS-1)	6	1870204	2314955	18-4037	—	—	—	—	—	—	—	—	—	—	—
115 (1150)	6	2836019	3525440	18-4037	18-4038	—	18-4036	18-1154	18-7151	18-2016	18-2016	18-7961	—	18-2016	—
115 (1150, 115)		3525441	5600966	18-4037	18-4038	—	18-4036	—	—	—	—	—	—	—	—
115	6	5600967	6262960	18-4037	18-4038	—	18-4036	—	—	—	—	—	—	—	—
115	6	6262961	C099999	18-4037	18-4038	—	18-4036	—	—	—	—	—	—	—	—
115 CONNECTING ROD #638-8532-1	4	C100000	D283221	—	—	—	—	18-1346	—	18-2016	—	18-7414	—	18-0523	—
115 OPTIMAX	6	G960500	T178499	—	18-1194	—	—	—	—	—	—	—	—	—	—
125 (1250, 1250BP)	6	2314956	2641954	18-4037	18-4038	—	18-4036	18-1154	18-2016	—	—	18-7961	—	18-2016	—
125 (1250BP)		2641955	3253111	18-4037	18-4038	—	—	—	—	—	—	—	—	—	—
125	4	D283222	& Sup	—	—	—	—	18-1346	—	18-2016	—	18-7414	—	18-0523	—
135 (1350)		2839369	3293233	18-4037	18-4038	—	18-4036	18-1154	18-7151	18-2016	18-2016	18-7961	—	18-2016	—
1400		3293234	3502805	18-4037	18-4038	—	18-4036	18-1154	—	—	—	—	—	—	—
1400-140		4865678	& Sup	18-4037	18-4038	—	18-4036	—	—	—	—	—	—	—	—
140 JET	V-6	D082000	& Sup	—	18-4039	—	—	18-1345	18-0860	18-2016	18-2016	18-0858	—	18-2016	—
V-135 W/ METAL CAGED MAIN BRG	V-6	A904646	C239552	—	18-1194	—	—	—	—	—	—	—	—	—	—
V-135 W/ PLASTIC CAGED MAIN BRG	V-6	A904646	C239552	—	18-1194	—	—	—	—	—	—	—	—	—	—
V-135 CONNECTING ROD #636-8118	V-6	C239553	D082000	—	18-1194	—	—	—	—	—	—	—	—	—	—
V-135	V-6	D082000	& Sup	—	18-1194	—	—	—	—	—	—	—	—	—	—
V-135 DFI	V-6	D082000	G760299	—	18-4039	—	—	18-1345	—	—	—	—	—	—	—
V-135 DFI	V-6	G760300	& Sup	—	18-1194	—	—	—	—	—	—	—	—	—	—

APLICACIONES CONTINÚAN EN LA SIGUIENTE PÁGINA

HP	Cil.	Desde nº de serie.	Hasta nº de serie	std.cil. diámetro	Rodillos	cojinete central	cojinete pistón	cojinete principal inferior	Aro inferior	Retén aceite inferior	Retén aceite inferior 2	Aro superior	Cojinete principal superior	Retén aceite superior	cojinete superior
1500-1500XS	V-6	3502806	5327662	18-4037	18-4038	—	18-4036	18-1154	18-7161	18-2016	18-2016	18-7961	—	18-2016	—
1500-1500XS	V-6	8005615	8052649	18-4037	18-4038	—	18-4036	—	—	—	—	—	—	—	—
1500-1500XS	V-6	7010533	7112772	18-4037	18-4038	—	18-4036	—	—	—	—	—	—	—	—
V-150 (V-1500)	V-6	4868998	C100860	—	18-4039	—	—	18-1345	—	18-2016	18-2016	—	—	18-2016	18-1196
V-150	V-6	C100861	C239552	—	18-1194	—	—	18-1345	18-0860	18-2016	18-2016	18-0858	—	18-2016	—
V-150 CONNECTING ROD #636-8118	V-6	C239553	D081999	—	18-1194	—	—	18-1345	18-0860	18-2016	18-2016	18-0858	—	18-2016	—
V-150 CONNECTING ROD #644-818141	V-6	C239553	D081999	—	18-1194	—	—	—	—	—	—	—	—	—	—
V-150 DFI	V-6	D082000	& Sup	—	18-1194	—	—	18-1345	18-0860	18-2016	18-2016	18-0858	—	18-2016	—
V-150 EFI	V-6	D082000	& Sup	—	18-4039	—	—	18-1345	—	—	—	—	—	—	—
150	V-6	4868998	D081999	—	18-1194	—	—	—	—	—	—	—	—	—	—
XR-4	V-6	G760300	& Sup	—	18-1194	—	—	—	—	—	—	—	—	—	—
XR-4	V-6	B242885	C239552	—	18-1194	—	—	—	—	—	—	—	—	—	—
XR-4	V-6	C239553	D081999	—	18-1194	—	—	—	—	—	—	—	—	—	—
XR-6	V-6	D082000	& Sup	—	18-4039	—	—	18-1345	—	—	—	—	—	—	—
V-175 (1750)	V-6	4301235	6618750	—	18-4039	—	—	18-1345	—	18-2016	18-2016	—	—	18-2016	18-1196
V-175	V-6	6618751	C239552	—	18-1194	—	—	18-1345	18-0860	18-2016	18-2016	18-0858	—	18-2016	—
V-175	V-6	C239553	D081999	—	18-1194	—	—	18-1345	18-0860	18-2016	18-2016	18-0858	—	18-2016	—
V-175	V-6	D082000	& Sup	—	18-1194	—	—	—	—	—	—	—	—	—	—
V-175 XRI	V-6	D000750	D081999	—	18-1194	—	—	18-1345	18-0860	18-2016	18-2016	18-0858	—	18-2016	—
V-175 EFI	V-6	D082000	& Sup	—	18-4039	—	—	18-1345	—	—	—	—	—	—	—
V-175	V-6	T178500	& Sup	—	18-1194	—	—	18-1345	18-0860	18-2016	18-2016	18-0858	—	18-2016	—
DFI & PRO XS															
175 (1750)	V-6	8058870	& Sup	—	18-1194	—	—	—	—	—	—	—	—	—	—
V-200 (V2000)	V-6	4839034	5363917	—	18-1194	—	—	18-1345	—	—	—	—	—	—	—
V-200 (V2000)	V-6	5363918	6073191	—	18-1194	—	—	18-1345	—	18-2016	18-2016	—	—	18-2016	18-1196
V-200 (2.4L)	V-6	6073192	C291519	—	18-1194	—	—	18-1345	18-0860	18-2016	18-2016	18-0858	—	18-2016	—
V-200 (2.5L) CONNECTING ROD #636-8118	V-6	C291520	D081999	—	18-1194	—	—	—	—	—	—	—	—	—	—
V-200 (2.5L) CONNECTING ROD #644-818141	V-6	C291520	D081999	—	18-1194	—	—	—	—	—	—	—	—	—	—
V-200	V-6	D082000	& Sup	—	18-4039	—	—	18-1345	—	—	—	—	—	—	—
V-200 EFI	V-6	C100861	C291519	—	18-1194	—	—	18-1345	18-0860	18-2016	18-2016	18-0858	—	18-2016	—
V-200 EFI CONNECTING ROD #644-818141	V-6	C291520	D081999	—	18-1194	—	—	—	—	—	—	—	—	—	—
V-200 EFI CONNECTING ROD #636-8118	V-6	C291520	D081999	—	18-1194	—	—	—	—	—	—	—	—	—	—
V-200 EFI (2.5L)	V-6	D082000	B226999	—	18-4039	—	—	18-1345	—	—	—	—	—	—	—
V-220	V-6	B117316	& Sup	—	18-1194	—	—	—	—	—	—	—	—	—	—
V-225	V-6	5628028	D280812	—	18-1194	—	—	18-1345	18-0860	18-2016	18-2016	—	—	18-2016	—
V-225 (225, SEAPRO)	V-6	D280813	& Sup	—	18-4039	—	—	18-1345	—	—	—	—	—	—	—
V-225 DFI	V-6	G590000	T325116	—	—	—	—	18-1345	18-0860	—	—	18-7414	—	—	—
V-225	V-6	G129222	& Sup	—	—	—	—	18-1345	18-0860	—	—	18-7414	—	—	—
V-250 EFI	V-6	G129222	T325116	—	—	—	—	18-1345	18-0860	—	—	18-7414	—	—	—
V-250	V-6	C101891	& Sup	—	18-4039	—	—	18-1345	—	—	—	18-7414	—	18-2016	—
V-250 DFI & PRO XS	V-6	B528615	& Sup	—	—	—	—	18-1345	18-0860	—	—	18-7414	—	—	—
V-275	V-6	C101891	& Sup	—	—	—	—	—	—	—	—	18-7414	—	—	—
V-3.4L	V-6	5611648	& Sup	—	18-4039	—	—	18-1345	—	—	—	18-7414	—	—	—



**18-2143
KIT SILENT BLOCK**

Reemplaza: 67210, 78249
Diámetro largo
Montaje parte inferior
Incluye: (1) monta jde de parte inferior y (2) 1 1/4" D.E. x 1/2" D.I. arandelas de acero inoxidable.



**18-2144
KIT SILENT BLOCK**

Reemplaza: 67209, 77326, 78687, 78687T
Diámetro corto
Montaje superior
Incluye: (1) Montaje parte superior y (1) 1 1/4" D.E. x 1/2" D.I. Arandelas de acero inoxidable



**18-7901
FILTRO ACEITE**

Reemplaza: 825467A1, T1
Para: 9.9HP S/N OH000058-OH017099 (1995-98)



**18-7758
FILTRO ACEITE**

Reemplaza: 35-877761K01, 35-877761Q01
Para: 75/90/115 hp. (S/N 1B366823 (2006) & Sup)



**18-7918
FILTRO ACEITE**

Reemplaza: 35-883701K01, 35-877769K01
Desde: Verado 200-300 HP, En línea 6 cilindros



**18-7921
FILTRO ACEITE**

Reemplaza: 35-896546T, 35-877767K01
Para: Verado 135-200 HP, En línea 4 cilindros



**18-7906-1
FILTRO ACEITE**

Reemplaza: 35-822626T7, 35-822626Q15, 35-8226267
Para: 225 HP (No-Verado)



**18-7913
FILTRO ACEITE**

Reemplaza: 35-822626Q1
Para: 8 HP (323cc) 2001-2004 / 9.9 HP (323cc) 1999-2004 / 15 HP. (323cc) 1998 y posteriores / 20 HP. 2008 y posteriores / 30 HP (492cc) 2006 y posteriores



**18-7914
FILTRO ACEITE**

Reemplaza: 35-822626Q2, 35-822626Q04, 35-877768K01, 35-822626K04, 35-822626T2, 35-8M0064104, 35-8M0008397
Para: 25 HP. (498cc) 1998-2005 / 30 HP. (747cc) 1999-2005 / 40, 50, 60 HP. 1995 y posteriores / 75, 90 Carburado 2000-2005 / 115 EFI (S/N 1B366822 y inferior)

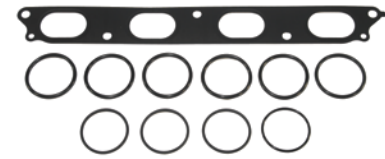

**18-0663
KIT JUNTA**

Para: Mercury 75 4-tiempos (2000-03), 90 4-tiempos (2000 & Sup),

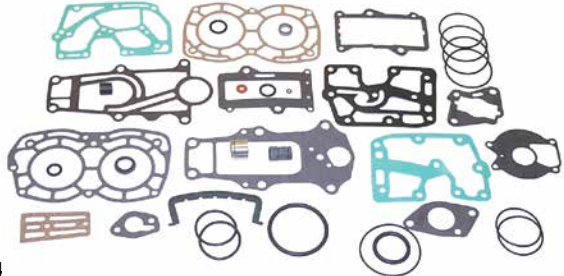

**18-4334
JUEGO DE JUNTAS BLOQUE**

Reemplaza: 27-41499A87
Desde: 15HP, 18HP, 20HP & 25HP fuerabordas

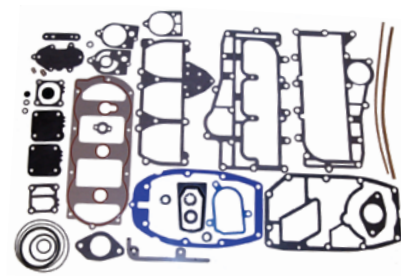

**18-4326
JUEGO DE JUNTAS BLOQUE**

Reemplaza: 27-43779A87
Desde: 50,55,60 HP, 3 cil.

-- CONTIENE --			
Ref #	Descripción	O.E.#	Cant.
18-4261	Arandela	19643	1
18-0320	Junta	27-13937-6	6
18-0324	Junta	27-15172-3	3
18-0670	Junta	27-43007 5	1
18-2565	Junta	27-43047-1	1
18-2945	Arandela	12-20260	3
18-7164	Aro tórico	25-33466	1
18-7198	Aro tórico	25-45710	1
18-7167	Aro tórico	25-45254	1
18-0182	Junta	27-62386	1
18-2740	Junta	27-43005 7	1
18-2741	Junta	27-43004 7	2
18-0339	Junta termostato	27-43006-2	1
18-0341	Junta	27-43008, 27-430082, 27-430083, 27-430085	1
18-2563	Junta	27-43034-1	1
18-2564	Junta	22-43033-1	1
18-2566	Junta impulsor	27-817277	1
18-7105	Aro tórico	25-62705	2
18-7414	Aro tórico	25-64067	1
18-0858	Aro tórico	25-54029	1
18-7803	Kit diafragma	21-857005A1	1

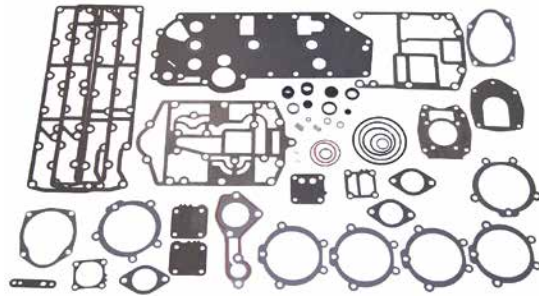

**18-4336
JUEGO DE JUNTAS BLOQUE**

Reemplaza: 27-43004A99, 27-43004A90, 27-43004A86
Desde: 70, 80, 90HP 3 cil fuerabordas

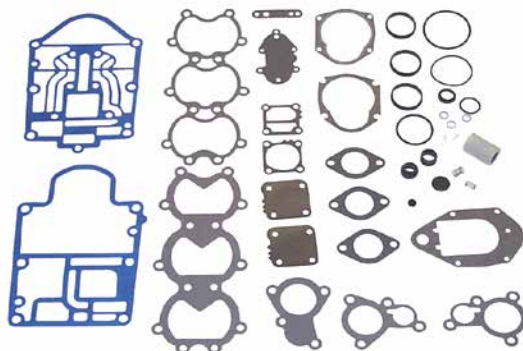

18-4337
JUEGO DE JUNTAS BLOQUE
 Reemplaza: 27-812867A97, 27-812867A96, 27-812867A91
 Desde: 45 Jet, 50HP, 55HP, 60HP, 3 cil Fueraborda

CONTIENE –			
Ref #	Descripción	O.E.#	Cant.
18-7152	Aro tórico	25-20863	1
18-2244	Arandela	10-79953A2	3
18-7173	Aro tórico	25-30224	1
18-0182	Junta termostato	27-62386	1
18-2719	Junta colector	27-812869	1
18-2721	Junta adaptador platina	27-827284	1
18-2729	Junta tapa termostato	27-812867 2	1
18-2749	Junta	27-812867 1	1
NSS	Junta escape	27-812866	1
18-0319	Junta tapa escape	27-828533	1
18-0622	Junta platina	27-19701	1
18-0345	Junta bomba de agua	27-722189	1
18-2593	Junta bomba de agua	N/A	1
18-2566	Junta impulsor	27-817277	1
18-7176	Aro tórico	25-90011	1
18-7950	Aro tórico	25-45258	1
18-7817	Kit diafragma	21-857005A1	1

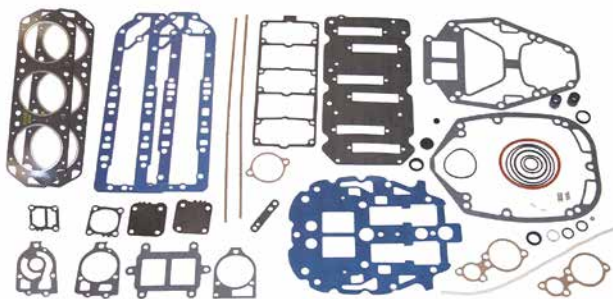

18-4339
JUEGO DE JUNTAS BLOQUE
 Reemplaza: 27-14697A87
 Para: V200EFI y V220 fueraborda

CONTIENE –			
Ref #	Descripción	O.E.#	Cant.
18-3862	Junta culata	27-41246-1	2
18-7153	Aro tórico	25-21836	1
18-7164	Aro tórico	25-33466	1
18-7159	Aro tórico	25-31534	1
18-0135	Junta	27-78246	1
18-7426	Aro	25-30271	1
18-0182	Junta	27-62386	2
18-0860	Aro tórico	25-62700	1
18-0936	Junta	27-78690	2
18-2919	Junta	27-42631-1	1
18-2915	Junta	27-85609-1	1
18-2506-1	Junta platina escape	27-99176-3	1
18-2503	Junta platina	27-99177-1	1
18-2513	Junta	27-11338	2
18-0644	Junta	27-14697-2	1
18-0645	Junta	27-16737-1	1
18-2502	Junta	27-90484-1	2
18-2511	Junta	27-99173-2	1
18-2914	Junta	27-85608-1	1
18-3110	Casquillo	26-38970	2
18-7174	Aro tórico	25-45711	2
18-7176	Aro tórico	25-90011	1
18-8305	Retén	26-814754	1
18-0858	Aro tórico	25-54029	1
18-0952	Junta	27-88907	1
18-7421	Aro tórico	25-20415	1
18-0970	Junta bomba combustible	27-98769-1	1
18-7817	Kit diafragma	21-857005A1	1

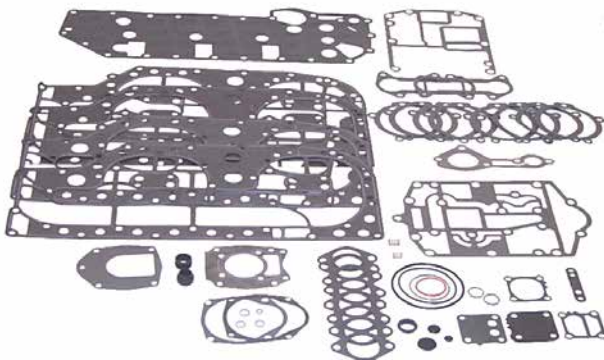

18-4340
JUEGO DE JUNTAS DE BLOQUE
 Reemplaza: 27-13461A99, 27-13461A90, 27-13461A89, 27-13461A88
 Para: 80 Jet, 100HP, 115HP, and 125HP 4 cil Fueraborda

CONTIENE –			
Ref #	Descripción	O.E.#	Cant.
18-4261	Arandela	19643	1
18-7961	Aro tórico	25-47254	1
18-0320	Junta	27-13937-6	8
18-0324	Junta	27-15172 4	8
18-0670	Junta	27-43007-5	1
18-2565	Junta	27-43047-2	1
18-2945	Arandela	12-19183	3
18-7198	Aro tórico	25-45710	1
18-0182	Junta	27-62386	1
NSS	Junta	27-13461-2	2
18-2943	Junta	27-44328-4	1
18-2621	Junta platina	27-13958-1	2
18-2610	Junta	27-812775-4	1
18-2611	Junta platina	27-812775-5	1
18-0339	Junta termostato	27-43006-2	1
18-0341	Junta	27-43008-6, 27-43008, 27-430082, 27-430083, 27-430085	1
18-2563	Junta	27-43034-1	1
18-2564	Junta	27-43033-1	1
18-2566	Junta impulsor	27-817277	1
18-7105	Aro tórico	25-62705	1
18-7414	Aro tórico	25-64067	1
18-0858	Aro tórico	25-54029	1
18-0970	Junta bomba combustible	27-98769-1	1
18-7817	Kit diafragma	21-857005A1	1

LAS APLICACIONES DE JUEGOS DE JUNTAS COMIENZAN 192
***JUEGO DE JUNTAS BLOQUE NO INCLUYE JUNTA CULATA**

— CONTIENE —

Ref #	Descripción	O.E.#	Cant.
18-0182	Junta termostato	27-62386	2
18-0858	Aro tórico	254029	1
18-0860	Aro tórico	25-62700	1
18-0129	Junta	27-65744-3	6
18-0135	Junta	27-78246	1
18-0936	Junta platina	27-78690	2
18-0952	Junta platina	27-88907	2
18-7421	Aro tórico	25-20415	2
18-7411	Aro tórico	25-35480	1
18-2501	Junta alojamiento	27-93536-1	1
18-2502	Junta	27-90484-1	2
18-2503	Junta platina	27-99177-1	1
18-2506	Junta platina	27-99176-3	1
18-2508	Junta platina	27-99776-1	2
18-2509	Junta montaje carburador	27-67751	3
18-2510	Junta alojamiento	27-96761-1	1
18-2511	Junta platina	27-99173-2	1
18-2513	Junta cilindro	27-11338	2
18-2803	Junta montaje carburador	27-90430	3
18-2808	Tapa cilindro	27-96278	2
18-2826	Junta alojamiento	27-85610-1	1
18-2914	Junta bomba de agua	27-85608-1	1
18-2915	Junta bomba de agua	27-85609-1	1
18-3110	Casquillo	26-38970	2
18-7153	Aro tórico	25-25439	1
18-7157	Aro tórico	25-29976	1
18-7159	Aro tórico	25-31534	1
18-7162	Aro tórico	25-33145	1
18-7164	Aro tórico	25-33466	1
18-7168	Aro tórico	25-48171	4
18-7174	Aro tórico	25-45711	2
18-7176	Aro tórico	25-90011	1
18-7812	Kit bomba combustible	89031A2	1
18-3863	Junta culata	27-96542-1	2
18-0359	Junta tapa	27-67275-1	1
18-0384	Junta carburador	27-89221-1	3
18-2919	Junta bomba de agua	27-42631-1	1
18-7406	Aro tórico	—	1

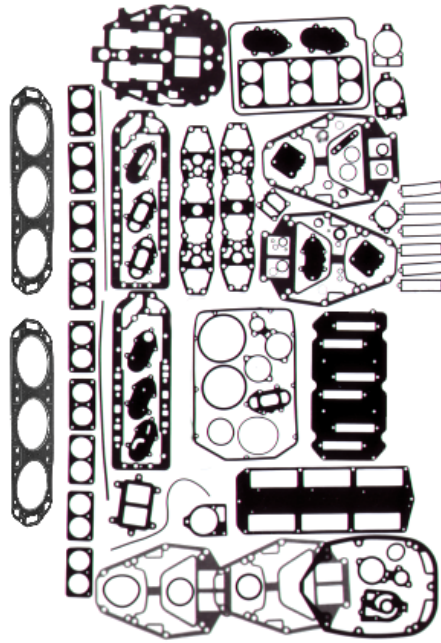

18-4317
JUEGO DE JUNTAS BLOQUE
 Reemplaza: 27-90484A88, 27-90484A86, 27-90484A32

— CONTIENE —

Ref #	Descripción	O.E.#	Cant.
18-0182	Junta termostato	27-62386	2
18-0858	Aro tórico	254029	1
18-0860	Aro tórico	25-62700	1
18-0129	Junta	27-65744-3	6
18-0135	Junta	27-78246	1
18-0936	Junta platina	27-78690	2
18-0952	Junta platina	27-88907	2
18-7421	Aro tórico	25-20415	2
18-7411	Aro tórico	25-35480	1
18-2501	Junta alojamiento	27-93536-1	1
18-2502	Junta	27-90484-1	2
18-2503	Junta platina	27-99177-1	1
18-2506	Junta platina escape	27-99176-3	1
18-2508	Junta platina escape	27-99776-1	2
18-2509	Junta montaje carburador	27-67751	3
18-2510	Junta alojamiento	27-96761-1	1
18-2511	Junta platina	27-99173-2	1
18-2513	Junta cilindro	27-11338	2
18-2803	Junta montaje carburador	27-90430	3
18-2808	Tapa cilindro	27-96278	2
18-2826	Junta alojamiento	27-85610-1	1
18-2914	Junta bomba de agua	27-85608-1	1
18-2915	Junta bomba de agua	27-85609-1	1
18-3110	Casquillo	26-38970	2
18-7153	Aro tórico	25-25439	1
18-7157	Aro tórico	25-29976	1
18-7159	Aro tórico	25-31534	1
18-7162	Aro tórico	25-33145	1
18-7164	Aro tórico	25-33466	1
18-7168	Aro tórico	25-48171	4
18-7174	Aro tórico	25-45711	2
18-7176	Aro tórico	25-90011	1
18-7812	Kit bomba combustible	89031A2	1
18-3862	Junta culata	27-41246-1	2
18-0359	Junta tapa	27-67275-1	1
18-0384	Junta carburador	27-89221-1	3
18-2919	Junta bomba de agua	27-42631-1	1
18-7406	Aro tórico	—	1
18-7176	Aro tórico	25-90011	1

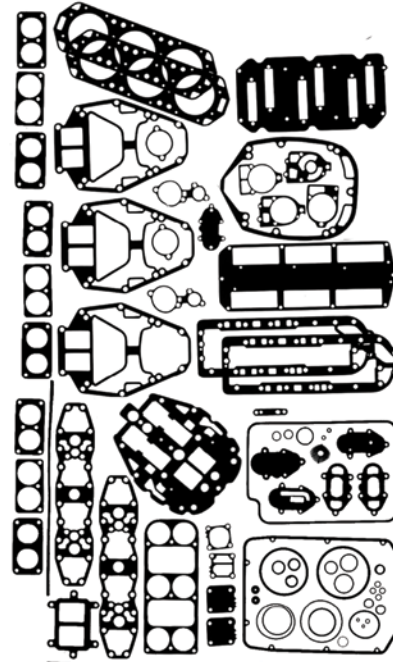

18-4319
JUEGO DE JUNTAS BLOQUE
 Reemplaza: 27-11338A88, 27-89221A88, 27-89221A85, 27-89221A84, 27-89221A32, 27-11338A85

— CONTIENE —

Ref #	Descripción	O.E.#	Cant.
18-0940	Junta escape	27-85488-2	1
18-0879	Junta platina	27-38501-1	1
18-2810	Junta tapa	27-43777-2	1
18-0103	Junta platina	27-79650-1	2
18-0137	Junta platina	27-85492-2	1
18-2800	Junta carburador	27-75791-1	2
18-0870	Junta tapa	27-27936-1	2
18-0539	Junta	37721	1
18-7161	Aro tórico	25-32546	1
18-2844	Junta termostato	27-48818-1	1
18-2823	Junta platina	27-19553	1
18-0938	Junta tubo de agua	27-79797-1	1
18-2825	Junta base bomba de agua	27-32771	1
18-7153	Aro tórico	25-25439	1
18-7151	Aro tórico	25-20081	1

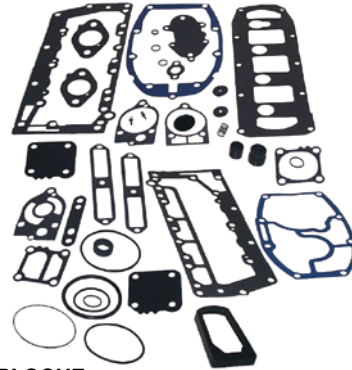

***18-4325**
JUEGO DE JUNTAS BLOQUE
 Reemplaza: 27-85491A90, 25-85491A87

— CONTIENE —

Ref #	Descripción	O.E.#	Cant.
18-0912	Junta Platina	27-66102-1	1
18-0133	Junta tapa	27-73665	1
18-0944	Junta tapa	27-85496-1	1
18-0107	Junta tapa escape	27-85498-1	1
18-7421	Aro tórico	25-20415	1
18-3110	Casquillo	26-38970	2
18-7411	Aro tórico	25-35480	1
18-2500	Junta tapa escape	27-85493	1
18-2514	Junta bloque	27-53650	2
18-2802	Junta carburador	27-48164-1	2
18-2826	Junta alojamiento	27-85610	1
18-2835	Junta culata	27-69238	1
18-2914	Junta bomba de agua	27-85608	1
18-2915	Junta bomba de agua	27-85609-1	1
18-7153	Aro tórico	25-25439	1
18-7157	Aro tórico	25-29976	1
18-7161	Aro tórico	25-32546	1
18-7162	Aro tórico	25-33145	1
18-7167	Aro tórico	25-47254	2
18-7807	Kit bomba de combustible	55278A1	1
18-0351	Junta tapa	27-55896	1
18-7426	Aro tórico	25-30271	1
18-4261	Arandela	19643	1

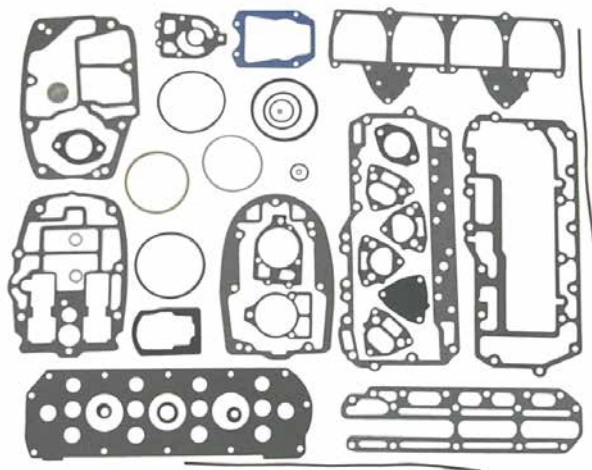

***18-4351**
JUEGO DE JUNTAS BLOQUE
 Reemplaza: 27-64203A75, 27-64203A74, 27-64203A73

— CONTIENE —

Ref #	Descripción	O.E.#	Cant.
18-0870	Junta tapa	27-27936-1	2
18-0879	Junta	27-30501-1	1
18-0103	Junta platina	27-79650-1	2
18-0938	Junta tubo de agua	27-79797-1	1
18-0942	Junta platina	27-85491-2	1
18-0137	Junta platina	27-85492-2	1
18-7421	Aro tórico	25-20415	1
18-2507	Junta tapa	27-85487	1
18-2800	Junta carburador	27-75791-1	2
18-2810	Junta tapa	27-43777-2	1
18-2823	Junta platina	27-32769, 27-19553	1
18-2824	Junta cuerpo	27-32770, 27-19551	1
18-2825	Junta base bomba de agua	27-32771	1
18-2841	Junta base bomba de agua	27-77417, 27-19552	1
18-7151	Aro tórico	25-20081	2
18-7153	Aro tórico	25-25439	1
18-7115	Aro tórico	25-26722	1
18-7155	Aro tórico	25-26855	1
18-7160	Aro tórico	25-31986	1
NSS	Aro tórico	25-29619	1
18-7413	Aro tórico	25-62702	2
18-7804	Kit bomba combustible	23014A1	1
18-2571	Junta carburador	27-31402	2



***18-4353**
JUEGO DE JUNTAS BLOQUE
 Reemplaza: 27-72486A32, 27-72486A79, 27-72486A78, 27-72486A76, 27-46110A72, 27-46110A2, 27-46110A1

— CONTIENE —

Ref #	Descripción	O.E.#	Cant.
18-0912	Junta platina	27-66102-1	1
18-0926	Junta tapa	27-73645	1
18-0133	Junta tapa	27-73665	1
18-0101	Junta platina carburador	27-76952	2
18-0944	Junta tapa	27-85496-1	1
18-0107	Junta tapa escape	27-85498-1	1
18-7421	Aro tórico	25-20415	1
18-3110	Casquillo	26-38970	1
18-7411	Aro tórico	25-35480	2
18-2500	Junta tapa escape	27-85493	1
18-2505	Junta tapa	27-96171-1	1
18-2514	Junta bloque	27-53650	2
18-2804	Junta carburador	27-73377-1	2
18-2826	Junta base bomba de agua	27-85610-1	1
18-2835	Junta culata	27-69238-1	1
18-2914	Junta bomba de agua	27-85608-1	1
18-2915	Junta bomba de agua	27-85609-1	1
18-7153	Aro tórico	25-25439	1
18-7157	Aro tórico	25-29976	1
18-7161	Aro tórico	25-32546	2
18-7162	Aro tórico	25-33145	1
18-7164	Aro tórico	25-33466	1
18-7167	Aro tórico	25-47254	2
18-7413	Aro tórico	25-62702	2
18-7808	Kit bomba combustible	55278A5	1
18-7426	Aro tórico	25-30271	1
18-4261	Arandela	19643	1

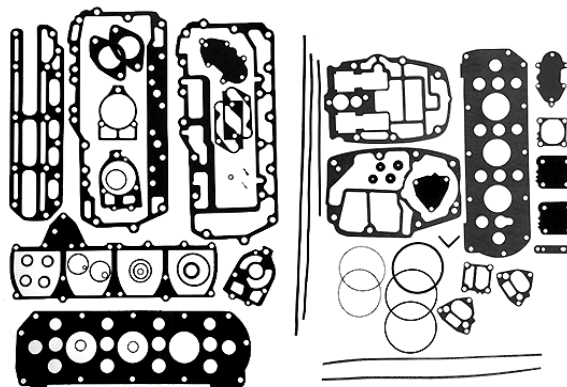

***18-4354**
JUEGO DE JUNTAS BLOQUE
 Reemplaza: 27-73645A87, 27-73645A76, 27-73645A32



***18-4355**
JUEGO DE JUNTAS BLOQUE
 Reemplaza: 27-78028A78, 27-55306A75, 27-55306A74, 27-55306A73, 27-55306A72

-- CONTIENE --

Ref #	Descripción	O.E.#	Cant.
18-0182	Junta termostato	27-62386	1
18-0879	Junta platina	27-38501-1	1
18-0988	Junta platina	27-62860-1	1
18-0914	Junta tapa termostato	27-66847	1
18-0938	Junta tubo de agua	27-79797-1	1
18-0940	Junta platina	27-85488-2	1
18-0105	Junta platina	27-85489-2	1
18-7421	Aro tórico	25-20415	1
18-7411	Aro tórico	25-35480	1
18-2802	Junta carburador	27-48164-1	1
18-2805	Junta tapa	27-85490-2	1
18-2823	Junta platina	27-19553	1
18-2824	Junta cuerpo bomba	27-19551	1
18-2825	Junta base bomba de agua	27-32771	1
18-2838	Junta tapa	27-55279-1	1
18-2841	Junta base bomba de agua	27-19552	1
18-7115	Aro tórico	25-26722	1
18-7143	Aro tórico	25-65936	2
18-7145	Aro tórico	25-64068	3
18-7153	Aro tórico	25-25439	1
18-7155	Aro tórico	25-26855	1
18-7160	Aro tórico	25-31986	1
18-7167	Aro tórico	25-47254	1
18-7413	Aro tórico	25-62702	3
18-7414	Aro tórico	25-64067	1
18-7807	Kit bomba combustible	55278A1	1
18-4261	Arandela	19643	1

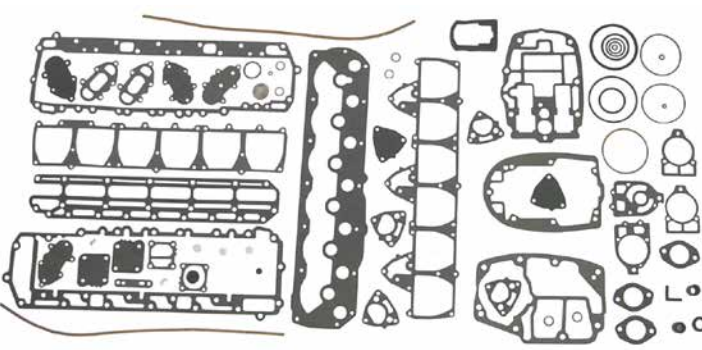

***18-4356**
JUEGO DE JUNTAS BLOQUE
 Reemplaza: 27-85653A87, 27-85653A79, 27-85653A32, 27-60476A75, 27-60476A74, 27-60476A73, 27-60476A72

-- CONTIENE --

Ref #	Descripción	O.E.#	Cant.
18-7153	Aro tórico	25-25439	1
18-7120	Aro tórico	25-38933	1
18-3110	Casquillo	26-38970	2
18-7164	Aro tórico	25-33466	1
18-7167	Aro tórico	25-47254	1
18-2802	Junta carburador	27-48164-1	3
18-7413	Aro tórico	25-62702	2
18-7161	Aro tórico	25-32546	2
18-7173	Aro tórico	25-30224	1
18-3110	Casquillo	26-38970	1
18-7421	Aro tórico	25-20415	1
18-7162	Aro tórico	25-33145	1
18-7157	Aro tórico	25-29976	1
18-2914	Junta bomba de agua	27-85608-1	1
18-2915	Junta bomba de agua	27-85609-1	1
18-2801	Junta bomba de agua	27-32438	1
18-2826	Junta alojamiento	27-85610-1	1
18-0912	Junta alojamiento	27-66102-1	1
18-2573	Junta tapa	27-72142-1	1
18-2574	Junta tapa escape	27-85495-2	1
18-0946	Junta	27-85653-1	1
18-2513	Junta carter a bloque	27-53862	2
18-2807	Junta tapa	27-98185	1
18-2835	Junta culata	27-69238-1	1
18-2839	Tapa escape	27-85497-2	1
18-7807	Kit bomba combustible	55278A1	2
18-7813	Kit bomba combustible	89031A3	1
18-7426	Aro tórico	25-30271	1

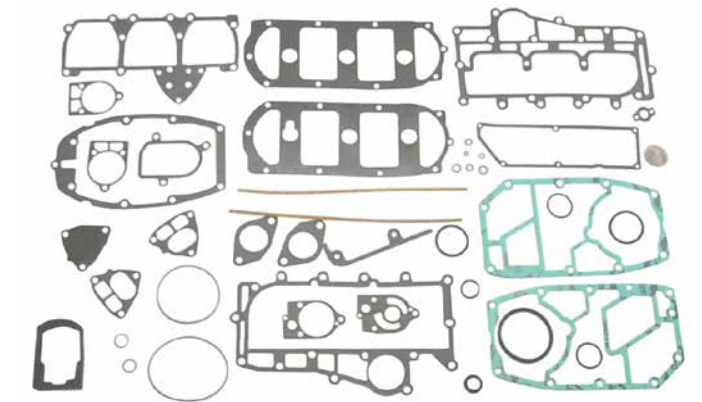

***18-4357**
JUEGO DE JUNTAS BLOQUE
 Reemplaza: 27-88449A32, 27-88449A80, 27-76589A79, 27-76589A78, 27-76589A77, 27-73440A76

-- CONTIENE --

Ref #	Descripción	O.E.#	Cant.
18-0182	Junta termostato	27-62386	1
18-0879	Junta platina	27-38501-1	1
18-0904	Junta	27-60317	1
18-0918	Junta platina	27-69524-2	1
18-0131	Junta platina	27-69525-2	1
18-0922	Junta platina	27-70335-1	1
18-0932	Junta tapa	27-76862-1	1
18-0938	Junta tubo de agua	27-79797-1	1
18-0139	Junta platina	27-88451-1	1
18-7421	Aro tórico	25-20415	1
18-2945	Tapón drenaje	12-20260	2
18-7411	Aro tórico	25-35480	1
18-2504	Junta tapa	27-88449	1
18-2512	Junta cigüeñal	27-60286	2
18-2804	Junta carburador	27-73377-1	2
18-2809	Junta tapa	27-43779-2	1
18-2823	Junta platina	27-19553	1
18-2824	Junta cuerpo bomba	27-19551	1
18-2825	Junta base bomba de agua	27-32771	1
18-2841	Junta base bomba de agua	27-19552	1
18-7143	Aro tórico	27-77417	1
18-7153	Aro tórico	25-25439	1
18-7115	Aro tórico	25-26722	1
18-7155	Aro tórico	25-26855	1
18-7160	Aro tórico	25-31986	1
18-7161	Aro tórico	25-32546	1
18-7413	Aro tórico	25-62702	2
18-7415	Aro tórico	25-64966	1
18-7809	Kit bomba combustible	55278A4	1
18-4261	Arandela	19643	1

- CONTIENE -			
Ref #	Descripción	O.E.#	Cant.
18-0135	Junta adaptador	27-78246	1
18-0182	Junta termostato	27-62386	2
18-0384	Junta carburador	27-89221-1	3
18-0641	Junta carburador	27-828292	3
18-0642	Junta platina	27-19050-3	1
18-0643	Junta platina	27-18307-1	1
18-0644	Junta platina	27-14697-2	1
18-0645	Junta adaptador	27-16737-1	1
18-0646	Junta platina	27-813859	1
18-0838	Aro tórico	-	1
18-0858	Aro tórico	25-54029	1
18-0860	Aro tórico	25-62700	1
18-0936	Junta válvula	27-78690	2
18-2506	Junta	27-99176-3	1
18-2509	Junta carburador	27-67751	3
18-2511	Junta platina	27-99173-2	1
18-2513	Junta cigüeñal	27-11338	2
18-2914	Junta bomba de agua	27-85608-1	1
18-2915	Junta bomba de agua	27-85609-1	1
18-2919	Junta bomba de agua	27-42631-1	1
18-3110	Retén	26-38970	2
18-7153	Aro tórico	25-25439	1
18-7157	Aro tórico	25-29976	1
18-7159	Aro tórico	25-31534	1
18-7174	Aro tórico	25-45711	1
18-7176	Aro tórico	25-90011	1
18-8305	Retén	26-814754	1

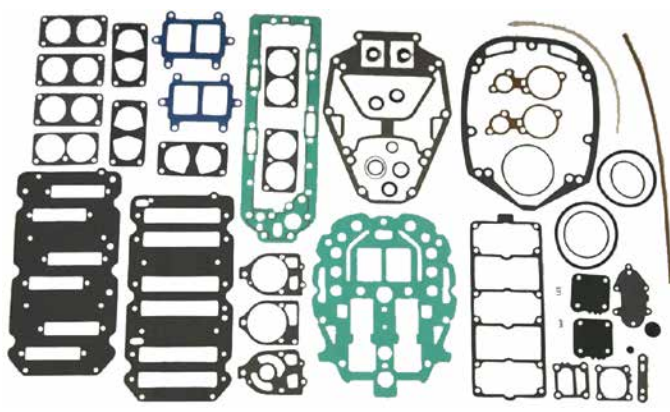

***18-4359**
JUEGO DE JUNTAS BLOQUE
 Reemplaza: 27-815791A92, 27-815792A90, 27-815810A90, 27-815809A90

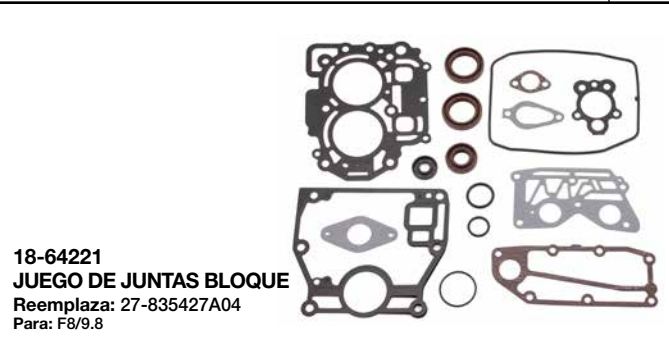

18-64221
JUEGO DE JUNTAS BLOQUE
 Reemplaza: 27-835427A04
 Para: F8/9.8

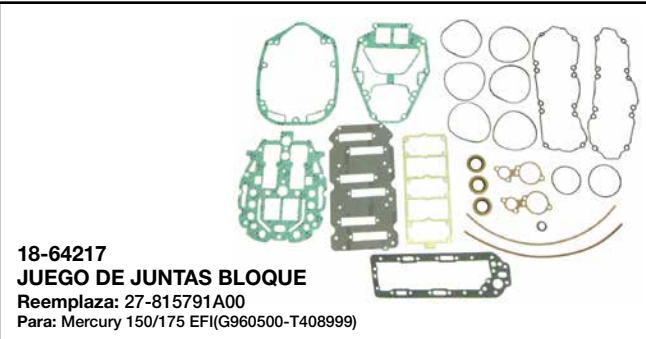

18-64217
JUEGO DE JUNTAS BLOQUE
 Reemplaza: 27-815791A00
 Para: Mercury 150/175 EFI(G960500-T408999)



18-2736
JUNTA CULATA
 Reemplaza: 27-863895,
 27-863891, 27-863893
 Para: 15-25HP 2 cil



18-3804
JUNTA CULATA
 Reemplaza: 27-19138M,
 19138, 27-84733M
 Para: Modelo 30A; S/N Cod. 689



18-3828
JUNTA CULATA
 Reemplaza: 27-18937M,
 27-18937, 27-98990M,
 27-83899M
 Para: Modelo 9.9C; S/N Code 682
 & Modelo 15C, S/N Cod. 684

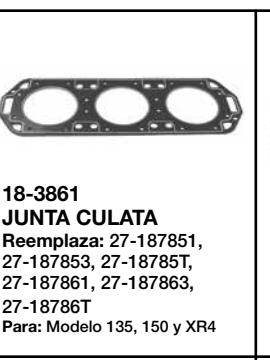

18-3861
JUNTA CULATA
 Reemplaza: 27-187851,
 27-187853, 27-18785T,
 27-187861, 27-187863,
 27-18786T
 Para: Modelo 135, 150 y XR4



18-3862
JUNTA CULATA
 Reemplaza: 27-41246-1
 Para: Modelo 175, 200, XR4



18-3844
JUNTA CULATA
 Reemplaza: 27-803508
 Para: 4-tiempos O/B's, 40/45/50 HP
 HP S/N OR000001 & Sup



18-3871
JUNTA CULATA
 Reemplaza: 27-18786-1
 Para: Modelo 175, XR4, Mag II



18-3863
JUNTA CULATA
 Reemplaza: 27-96542-1
 Para: Modelo 150



18-3864
JUNTA CULATA
 Reemplaza: 27-822844-1
 Para: Modelo 175, 200 y XR6



18-3872
JUNTA CULATA
 Reemplaza: 27-41245-1
 Para: 200 y 225 HP

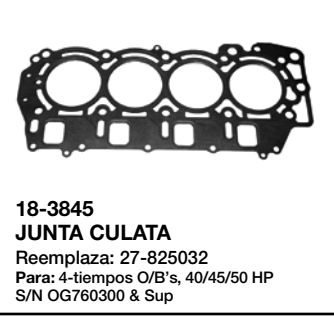

18-3845
JUNTA CULATA
 Reemplaza: 27-825032
 Para: 4-tiempos O/B's, 40/45/50 HP
 S/N OG760300 & Sup



18-3827
JUNTA CULATA
 Reemplaza: 27-8254821, 27-825482
 Para: 8, 9.9 HP 4-tiempos



18-60916
JUNTA CULATA
 Reemplaza: 27-850836001
 Para: Mercury 8/9.9 (R042475 & Sup)

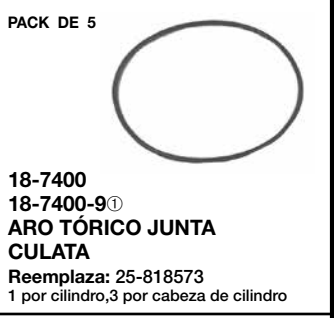

PACK DE 5
18-7400
18-7400-9①
ARO TÓRICO JUNTA CULATA
 Reemplaza: 25-818573
 1 por cilindro, 3 por cabeza de cilindro

① Precio por envase

LAS APLICACIONES COMIENZAN EN LA SIGUIENTE HOJA
 *JUEGO DE JUNTAS BLOQUE NO INCLUYE JUNTA CULATA

JUNTA CULATA/APLICACIONES JUEGO DE JUNTAS













Modelo	Cil.	Desde Nº de serie	Hasta Nº de serie	Juego de juntas	Aro tórico	Junta culata	Sellos de cabeza
4/5/6 (4 tiempos)	1 CIL	R000001	& Sup	—	—	18-3844	—
8 4 tiempos (232cc)		H000058	H017349	—	—	18-3827	—
8 4 tiempos (232cc)		G760300	T178499	—	—	18-3827	—
9.9 tiempos (232cc)		H000058	H017349	—	—	18-3827	—
18 (18XD)	2	6416713	6443972	18-4334	—	—	—
20 (20,20XD, 200)	2	6443973	OT800999	18-4334	—	—	—
20 JET	2	G044027	& Sup	18-4334	—	—	—
30 JET (40 HP)	4 CIL	C159200	& Sup	18-4325	—	—	—
35	2 CIL	6445653	B110788	18-4355	—	—	—
40,402	2 CIL	3336258	G053313	18-4355	—	—	—
40	4 CIL	C159200	& Sup	18-4325	—	—	—
40 4 tiempos (232cc)	3 CIL	G231123	T178499	—	—	18-3845	—
45	4 CIL	5531630	0B110788	18-4353	—	—	—
45	4 CIL	B110789	& Sup	18-4325	—	—	—
45 Jet	3 CIL	D000750	& Sup	18-4337	—	—	—
45 4 tiempos (BODENSEE)		G231123	T178499	—	—	18-3845	—
50,500	4 CIL	2116318	& Sup	18-4353	—	—	—
50, 60	4 CIL	6428681	B122929	18-4357	—	—	—
50	3 CIL	D000750	OG589999	18-4337	—	—	—
50	3 CIL	B122930	D000749	18-4326	—	—	—
50 4 tiempos		G231123	T178499	—	—	18-3845	—
55	3 CIL	6428681	B122929	18-4357	—	—	—
55	3 CIL	D000750	& Sup	18-4337	—	—	—
65 (650)	3 CIL	3293184	4382056	—	—	—	—
65 (650)	3 CIL	4382057	4571651	18-4357	—	—	—
70	3 CIL	4571652	A996141	18-4357	—	—	—
70	3 CIL	A996142	& Sup	18-4336	—	—	—
75	4 CIL	6432901	& Sup	18-4354	—	—	—
80	3 CIL	A996142	& Sup	18-4336	—	—	—
80 Jet	4 CIL	D283222	& Sup	18-4340	—	—	—
80,800	4 CIL	2559001	3493912	18-4350	—	—	—
80,800	4 CIL	4831999	6432900	18-4354	—	—	—
85,850	4 CIL	3493913	4366801	18-4351	—	—	—
85,850	4 CIL	4366802	4831998	18-4354	—	—	—
90,900	6 CIL	4845301	& Sup	18-4356	—	—	—
90	3 CIL	A996142	& Sup	18-4336	—	—	—
100	4 CIL	B209468	& Sup	18-4340	—	—	—
105 JET	6 CIL	D082000	& Sup	18-4359	—	18-3864 ^②	— 1
115	4 CIL	C100000	& Sup	18-4340	—	—	—
125	4 CIL	D283222	& Sup	18-4340	—	—	—
140 (140, 1400)	6 CIL	3293234	3502805	18-4356	—	—	—
140 (140, 1450)	6 CIL	4865678	& Sup	18-4356	—	—	—
140 (140, 1400)	6 CIL	4865678	& Sup	18-4356	—	—	—
150 (1500)	6 CIL	3502806	5327622	18-4356	—	—	—
V-135	V-6	A904646	C239552	18-4317 □	—	18-3863	—
V-135	V-6	C239553	G960499	18-4359	—	18-3861	— 1
V-135 DFI	V-6	G590000	G960499	18-4338	—	—	— 1
140 JET	V-6	D082000	G960499	18-4359	—	18-3864	— 1
V-150 (150, 1500)	V-6	4868998	6042945	18-4315	—	—	—
V-150	V-6	6042946	C239552	18-4317 □	—	18-3863	—
V-150	V-6	C239553	G960499	18-4359	—	18-3861	— 1
V-150	V-6	G960500	& Sup	18-4338	—	—	— 6
V-150 (XR/MAGNUM II)	V-6	B242885	C239552	18-4319 □	—	—	—
V-150 XR4	V-6	C239553	D081999	18-4359	—	18-3871	— 1
V-150 (XR6/MAGNUM III)	V-6	D082000	G960499	18-4359	—	18-3864 ^{②④}	— 1
V-150 (EFI)		D082000	G960499	18-4359	N/D	—	— 1



















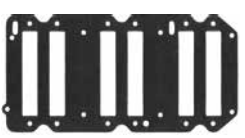

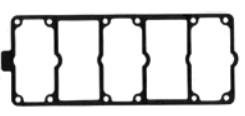



- ① Juego de juntas incluye junta culata ④ Usado en un 2.5L con 3.5" 2 Aros y retenes no incluidos en el kit
 ② Necesita 2 juntas culata ⑤ necesita 3 por cabeza de cilindro 3 Aros y retenes no incluidos en el kit 6 Aros y retenes no incluidos en el kit
 ③ Usado en un 2.4L con 3.38" 1 Junta culata no incluida en kit

JUNTA CULATA/APLICACIONES JUEGO DE JUNTAS

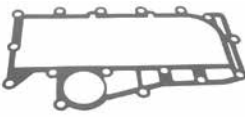
Modelo	Cil.	Desde Nº de serie	Hasta Nº de serie	Juego de juntas	Aro tórico	Junta culata	Sellos de cabeza
150 MAR	V-6	5600162	6038680	18-4315	—	—	—
150 MAR	V-6	6038681	C239553	18-4317 ①	—	18-3863②	—
150 MAR	V-6	C239554	& Sup	18-4359	—	18-3861②	—
V-175 (175, 1750)	V-6	4301235	6618750	18-4315	—	—	—
V-175	V-6	6618751	C239552	18-4319 ①	—	18-3862	—
V-175	V-6	C239553	D081999	18-4359	—	18-3871②③	— 1
V-175	V-6	D082000	G960499	18-4359	—	18-3864③④	—
V-175 (EFI)	V-6	D000750	D081999	18-4359	—	18-3871②③	— 1
V-175 XRI EFI	V-6	D000750	D081999	18-4359	—	18-3864②④	—
V-175 (EFI)	V-6	D082000	G303045	18-4359	—	18-3864②④	— 1
V-200 (200,2000)	V-6	4839034	6073191	—	—	18-3872②	—
V-200	V-6	6073192	6203990	—	—	18-3872②	—
V-200	V-6	6203991	C291519	18-4319 ①	—	18-3862②③	—
V-200	V-6	C291520	D081999	18-4359	—	18-3864②④	— 1
V-200	V-6	D082000	G960499	18-4359	—	—	— 1
V-200 (EFI)	V-6	C100861	OC291519	18-4339	—	18-3862	—
V-200 (EFI)	V-6	C291520	G960499	18-4359	—	18-3864	— 1
V-200 (DFI) 3.0L	V-6	G386496	G589999	—	18-7400	—	—
V-200 (DFI) 3.0L	V-6	G590000	G960499	18-4335	18-7400	—	— 2
V-200 (DFI) 3.0L	V-6	G960500	T178499	—	18-7400	—	— 3
V-200 XRI EFI	V-6	C100861	C291519	—	—	18-3862②	—
V-200 XRI EFI	V-6	C291520	& Sup	18-4359	—	18-3864②④	—
V-220	V-6	B117316	& Sup	18-4339	—	18-3862②	—
V-225 SEA PRO	V-6	G245605	OT408999	—	18-7400 ⑤	—	—
V-225 (EFI) 3.0L	V-6	G129222	T408999	—	18-7400 ⑤	—	—
V-225 DFI (3.0L)	V-6	G590000	OG960499	18-4335	18-7400 ⑤	—	— 3
V-225 DFI (3.0L)	V-6	G960500	T178499	—	18-7400 ⑤	—	— 3
V-250 (EFI) 3.0L	V-6	G129222	T408999	—	18-7400 ⑤	—	—

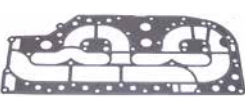























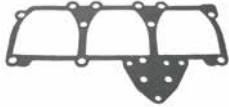



- ① Juego de juntas incluye junta culata ④ Usado en un 2.5L con 3.5" 2 Aros y retenes no incluidos en el kit
 ② Necesita 2 juntas culata ⑤ Necesita 3 por cabeza de cilindro 3 Aros y retenes no incluidos en el kit 6 Aros y retenes no incluidos en el kit
 ③ Usado en un 2.4L con 3.38" 1 Junta culata no incluida en kit

 18-0101 JUNTA CARBURADOR Reemplaza: 27-76952, 27-73397 4 Cil.	 18-0324 JUNTA CARBURADOR Reemplaza: 27-15172 3, 27-151724, 27-15172, 27-93214	 18-0384 JUNTA CARBURADOR Reemplaza: 27-892211, 27-817533, 27-89221, 27-8M0027781 200/225 HP	 18-0633 JUNTA CARBURADOR Reemplaza: 27-192061, 27-42178, 27-19206, 27-414491, 27-41449	
 18-0641 JUNTA CARBURADOR Reemplaza: 27-828292	Pack. de 3  18-2509 18-2509-9⑥ JUNTA CARBURADOR Reemplaza: 27-67751 V-6	Pack. de 2  18-2571 18-2571-9⑥ JUNTA CARBURADOR Reemplaza: 27-31402	Pack. de 2  18-2572 18-2572-9⑥ JUNTA CARBURADOR Reemplaza: 27-63309, 27-22023	
Pack. de 2  18-2800 18-2800-9⑥ JUNTA CARBURADOR Reemplaza: 27-757911, 27-75791, 27-69659, 27-26891 20-45-50 HP	Pack. de 2  18-2802 18-2802-9⑥ JUNTA CARBURADOR Reemplaza: 27-48164, 27-481641	Pack. de 3  18-2803 18-2803-9⑥ JUNTA CARBURADOR Reemplaza: 27-90430, 27-904301 V-6	Pack. de 4  18-2804 18-2804-9⑥ JUNTA CARBURADOR Reemplaza: 27-733771, 27-73377 3-4 Cil.	 18-60915 JUNTA CARBURADOR Reemplaza: 27-835383001 Para: Mercury 8/9.9 (R042475 & Sup)



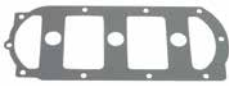













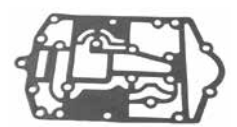

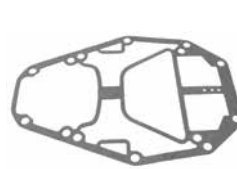
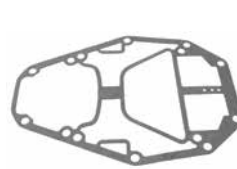

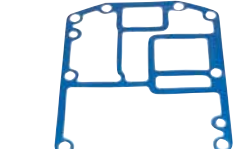

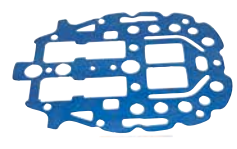
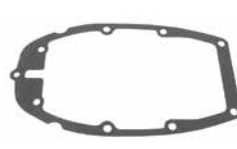

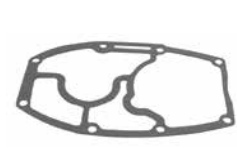
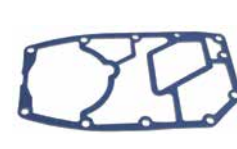
 <p>18-2568 18-2568-9① JUNTA TAPA Reemplaza: 27-25848</p>	 <p>18-2569 18-2569-9① JUNTA TAPA FILTRO Reemplaza: 27-25849</p>	 <p>18-2570 18-2570-9① JUNTA TAPA Reemplaza: 27-25851, 27-34614</p>	 <p>18-2575 18-2575-9① JUNTA CARBURADOR Reemplaza: 1399-99</p>	 <p>18-0970 18-0970-9① BASE BOMBA COMBUSTIBLE Reemplaza: 27-987691, 27-98769</p>												
 <p>18-0359 JUNTA TAPA SILENCIADOR Reemplaza: 27-672751, 27-67275</p>	 <p>18-0129 JUNTA Reemplaza: 27-657443, 27-657442, 27-657441, 27-65744 V-6</p>	 <p>18-0320 JUNTA Reemplaza: 27-13937-6</p>	 <p>18-0644 JUNTA PLATINA Reemplaza: 27-146972</p>													
 <p>18-0646 JUNTA PLATINA Reemplaza: 27-813859</p>	 <p>18-2501 18-2501-9① JUNTA ALOJAMIENTO Reemplaza: 27-935361, 27-93536, 27-67738 V-6</p>	 <p>18-2510 18-2510-9① JUNTA ALOJAMIENTO Reemplaza: 27-967611, 27-96761 V-200</p>	<p>JUNTAS CARCASA CIGÜEÑAL</p> <table border="1"> <thead> <tr> <th>Ref #</th> <th>Reemplaza:</th> <th>Descripción</th> </tr> </thead> <tbody> <tr> <td>18-2512 ②</td> <td>27-60286</td> <td>Junta carter 3 cilindros</td> </tr> <tr> <td>18-2513 ②</td> <td>27-11338, 27-67208</td> <td>Junta carter V-6</td> </tr> <tr> <td>18-2514 ②</td> <td>27-53650</td> <td>Junta carter 4 cilindros</td> </tr> </tbody> </table>		Ref #	Reemplaza:	Descripción	18-2512 ②	27-60286	Junta carter 3 cilindros	18-2513 ②	27-11338, 27-67208	Junta carter V-6	18-2514 ②	27-53650	Junta carter 4 cilindros
Ref #	Reemplaza:	Descripción														
18-2512 ②	27-60286	Junta carter 3 cilindros														
18-2513 ②	27-11338, 27-67208	Junta carter V-6														
18-2514 ②	27-53650	Junta carter 4 cilindros														
 <p>18-0645 JUNTA PLATINO Reemplaza: 27-167371</p>	 <p>18-0105 JUNTA PLATINA Reemplaza: 27-85489-2</p>	 <p>18-0107 JUNTA TAPA ESCAPE Reemplaza: 27-85498-1, 27-85498, 27-64203, 27-72510 4 Cil.</p>	 <p>18-0131 JUNTA Reemplaza: 27-695252, 27-695251, 27-69525, 27-64857 3 Cil.</p>	 <p>18-0133 JUNTA TAPA Reemplaza: 27-73665, 27-52892 4 Cil.</p>												
 <p>18-0137 JUNTA PLATINA Reemplaza: 27-85492-2 50 HP</p>	 <p>18-0371 JUNTA PLATINA Reemplaza: 27-78409, 27-39316, 27-72915 20 HP</p>	 <p>18-0373 JUNTA PLATINA Reemplaza: 27-78411, 27-45088, 27-72917 20 HP</p>	 <p>18-0918 JUNTA TAPA ESCAPE Reemplaza: 27-695242, 27-695241, 27-69524 3 Cil.</p>	 <p>18-2712 JUNTA PLATINA Reemplaza: 27-414181, 27-41418, 27-85979 Para: 15-25 2 cil</p>												
 <p>18-2621 JUNTA PLATINA Reemplaza: 27-139581 Para: 100HP 4 cil, 115HP 4 cil</p>	 <p>18-2710 JUNTA Reemplaza: 27-414172, 27-414171, 27-41417, 27-85978 Para: 15-25HP 2 cil</p>	 <p>18-2721 JUNTA TERMOSTATO Reemplaza: 27-827284 Para: 30-60HP 3 cil fuerabordas</p>	 <p>18-2729 JUNTA TERMOSTATO Reemplaza: 27-8128672 Para: 30-40HP 2 cil, 45 Jet, 50-60 3 cil</p>	 <p>18-2749 JUNTA TERMOSTATO Reemplaza: 27-8128671, 27-812867 Para: 45 Jet, 50-60 HP 3 cil</p>												



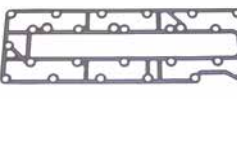



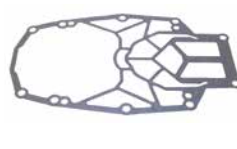



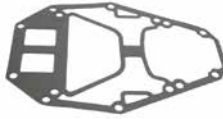

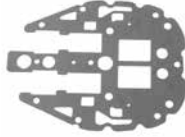
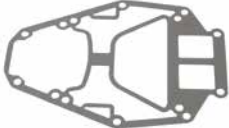

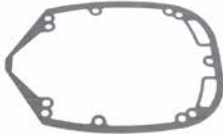





① Precio por envase

② Este producto tiene un precio por pieza . Para pedir el precio por paquete , por favor agregue -9 al número de pieza











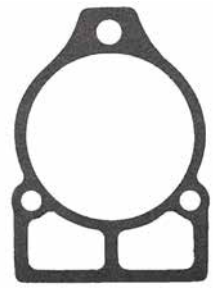

 <p>18-3675 JUNTA TERMOSTATO Reemplaza: 27-850318, 27-8503181 Para: 200-250HP 3.0L, (DFI y EFI)</p>	<p>Pack. de 2</p>  <p>18-0922 18-0922-9① JUNTA PLATINA Reemplaza: 27-703351, 27-70335 3 Cil.</p>	 <p>18-0940 JUNTA PLATINA Reemplaza: 27-854882, 27- 854881, 27-85488, 27-78027, 27-55308</p>	 <p>18-0942 JUNTA PLATINA Reemplaza: 27-85491-2, 27-854913, 27-854911, 27-85491, 27-72486, 27-46110 45/50 HP</p>	 <p>18-0944 JUNTA PLATINA Reemplaza: 27-854961, 27-85496, 27-64204, 27-72508</p>
 <p>18-0232 JUNTA TAPA Reemplaza: 27-81031M</p>	<p>Pack. de 2</p>  <p>18-2573 18-2573-9① JUNTA TAPA Reemplaza: 27-721421, 27-72142, 27-60475 6 Cil.</p>	<p>Pack. de 2</p>  <p>18-2574 18-2574-9① JUNTA TAPA ESCAPE Reemplaza: 27-854952, 27- 854951, 27-85495, 27-72507, 27-60476 6 Cil.</p>	<p>Pack. de 2</p>  <p>18-2836 18-2836-9① JUNTA TAPA ESCAPE Reemplaza: 27-78035, 27-72919, 27-46233, 27-31439 7.5-10 HP</p>	<p>Pack. de 2</p>  <p>18-2839 18-2839-9① JUNTA TAPA ESCAPE Reemplaza: 27-854972, 27-854971, 27-85497, 27-72509, 27-60477</p>
 <p>18-0151 JUNTA TAPA ESCAPE Reemplaza: 27-76636, 27-75952 V-6</p>	 <p>18-0642 JUNTA Reemplaza: 27-190503, 27-19050, 27-190502, 27-190505</p>	<p>Pack. de 2</p>  <p>18-2502 18-2502-9① JUNTA PLATINA Reemplaza: 27-904841, 27-90484, 27-87396 V-6</p>	 <p>18-0870 JUNTA TAPA Reemplaza: 27-279361, 27-27936</p>	 <p>18-0926 JUNTA TAPA Reemplaza: 27-73645</p>
 <p>18-0932 JUNTA TAPA Reemplaza: 27-768621, 27-76862 3 Cil.</p>	 <p>18-0946 JUNTA TAPA Reemplaza: 27-85653-1, 27-856730, 27-85653 6 Cil.</p>	<p>Pack. de 3</p>  <p>18-2838 18-2838-9① JUNTA TAPA Reemplaza: 27-552791, 27-55279</p>	 <p>18-0372 JUNTA TAPA Reemplaza: 27-78410, 27- 52579, 27-72916 20 HP</p>	 <p>18-2740 JUNTA TAPA Reemplaza: 27-430057, 27-430056, 27-430055, 27- 430053, 27-430052, 27-430051 Para: 65 Jet, 75HP 3 cil, 90HP 3 cil</p>
 <p>18-2943 JUNTA TAPA Reemplaza: 27-443281, 27-443282, 27-443283, 27-443284 Para: 81 Jet, 100HP, 115HP, y 125HP 4 cil fuerabordas</p>	<p>Pack de 2</p>  <p>18-2500 18-2500-9① JUNTA TAPA ESCAPE Reemplaza: 27-85493, 27-72505, 27-52893 80 HP</p>	<p>Pack de 2</p>  <p>18-2505 18-2505-9① JUNTA TAPA Reemplaza: 27-961711, 27-96171 75-80 HP</p>	<p>Pack de 2</p>  <p>18-2507 18-2507-9① JUNTA TAPA Reemplaza: 27-85487, 27- 78026, 27-72487, 27-37816 40-50 HP</p>	<p>Pack de 2</p>  <p>18-2805 18-2805-9① JUNTA TAPA Reemplaza: 27-85490-2 35-40 HP</p>
<p>Pack. de 2</p>  <p>18-2504 18-2504-9① JUNTA TAPA BLOQUE Reemplaza: 27-88449, 27-76401, 27-74511, 27-60310 3 Cil.</p>	<p>Pack. de 2</p>  <p>18-2806 18-2806-9① JUNTA TAPA Reemplaza: 27-65788 V-6</p>	<p>Pack. de 2</p>  <p>18-2807 18-2807-9① JUNTA TAPA Reemplaza: 27-981853, 27-9818512, 27-981851, 27-98185, 27-85494, 27-72506, 27-64940, 27-53863 90-115 HP</p>	<p>Pack. de 2</p>  <p>18-2808 18-2808-9① JUNTA TAPA Reemplaza: 27-96278 V-6</p>	 <p>18-60917 JUNTA TAPA CILINDRO Reemplaza: 27-803508017 Para: Mercury 8/9.9 (R042475 & Sup)</p>

① Precio por envase

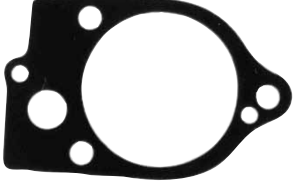
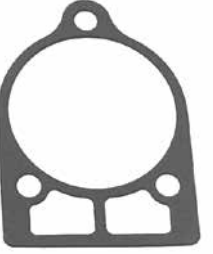
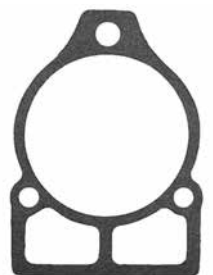
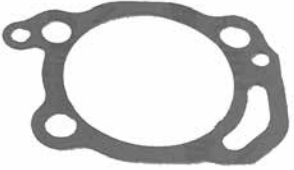
<p>Pack. de 2</p>  <p>18-2810 18-2810-9① JUNTA TAPA Reemplaza: 27-437772, 27-437771, 27-43777, 27-96483 45-50 HP</p>	<p>Pack. de 2</p>  <p>18-2837 18-2837-9① JUNTA TAPA Reemplaza: 27-41382, 27- 78087, 27-72918, 27-66358, 27-31436</p>	 <p>18-0333 JUNTA BASE Reemplaza: 27-39401</p>	 <p>18-0334 JUNTA BASE Reemplaza: 27-39402</p>	 <p>18-0336 JUNTA BASE Reemplaza: 27-41670-3, 27-41670-5 18 HP</p>
<p>18-0649 JUNTA ALOJAMIENTO CAMBIO Reemplaza: 27-858935 Para: 200 HP T801000 & SUP, 200 HP OPTIMAX DFI G438000 & SUP, 225 HP EFI G438000 & SUP, 225 HP OPTIMAX DFI G590000-G960499, 250 HP EFI G438000 & SUP, (MODELOS CON "C-3": 200 HP OPTI- MAX DFI G386496-G437999, 225 HP D280813-G437999, 225 HP EFI G129222-G437999, 250 HP EFI G129222-G437999)</p> 	 <p>18-0341 JUNTA BASE Reemplaza: 27-430086, 27-43008, 27-430082, 27- 430083, 27-430085 Para: 70-90, 100, 115 & 125 HP</p>	 <p>18-0791 JUNTA TAPA CAMBIO Reemplaza: 27-880729 Para: Todos los verado 135/150/175/200 225/250/275</p>	 <p>18-0369 JUNTA BASE Reemplaza: 27-75909 V-6</p>	
 <p>18-0378 JUNTA BASE Reemplaza: 27-823142, 27-823142 2</p>	 <p>18-0670 JUNTA BASE Reemplaza: 27-430075, 27-430073, 27-43007</p>	 <p>18-0385 JUNTA BASE Reemplaza: 27-89937, 27-31557, 27-30803, 27-45748 4.5-9.8 HP</p>	 <p>18-0643 JUNTA BASE Reemplaza: 27-18307-1, 27-183076</p>	 <p>18-0879 JUNTA BASE Reemplaza: 27-385011, 27-38501, 27-37724</p>
 <p>18-0904 JUNTA BASE Reemplaza: 27-60317 65 HP</p>	 <p>18-0135 JUNTA ADAPTADOR Reemplaza: 27-78246, 27-78246 1</p>	 <p>18-0103 JUNTA BASE Reemplaza: 27-796501, 27-79650, 27-37725, 27-72496</p>	 <p>18-0139 JUNTA BASE Reemplaza: 27-884511, 27-88451, 27-78623, 27-76589</p>	 <p>18-2735 JUNTA PLATINA Reemplaza: 27-190506 Para: 140 Jet, 115-200HP (2.5L), XR-6</p>
 <p>18-2713 JUNTA ALOJAMIENTO Reemplaza: 27-433374, 27-43337, 27-43337A1, 27-433371, 27-433372, 27-433373, 27-96286 Para: 15-25 2 cil</p>	 <p>18-2714 JUNTA TAPA ESCAPE Reemplaza: 27-414995, 27-414994, 27-414993, 27-414992, 27-892157 Para: 15-25 HP, 2 Cil.</p>	 <p>18-2716 JUNTA TAPA ESCAPE Reemplaza: 27-414991, 27-41499, 27-92332 Para: 18XD, 20XD (2 cil), 25XD</p>	 <p>18-2741 JUNTA TAPA ESCAPE Reemplaza: 27-430047, 27-430045, 27-430043, 27-430042, 27-430041, 27-43004009 Para: 65 Jet, 75HP 3 cil, 90HP 3 cil</p>	 <p>18-2717 JUNTA COLECTOR ESCAPE Reemplaza: 27-414758, 27-414757, 27-414756, 27-414755, 27-414754, 27-414753, 27-414752, 27- 414751, 27-41475, 27-92331, 27-892158 Para: 15-25HP 2 cil</p>
 <p>18-0319 JUNTA BASE Reemplaza: 27-828553 Para: 30-60HP 2 cil and 3 cil</p>	 <p>18-2610 JUNTA Reemplaza: 27-8127754, 27-812755 Para: 81 Jet, 100HP, 115HP, y 125HP 4 cil fuerabordas</p>	 <p>18-2739 JUNTA PLATINA Reemplaza: 27-8329335, 27-8329334, 27-8329333, 27-8329332, 27-8329331, 27-832933006 Para: 250XS (3.0L) DFI</p>	 <p>18-2611 JUNTA Reemplaza: 27-8127551, 27-8127755, 27-812755A01 Para: 80 Jet, 100HP, 115HP, y 125HP 4 cil fueraborda</p>	 <p>18-0912 JUNTA PLATINA ALOJAMIENTO EJE Reemplaza: 27-661021, 27-66102, 27-60945</p>

 <p>18-0934-1 JUNTA BASE BLOQUE Reemplaza: 27-78069</p>	 <p>18-0988 JUNTA BASE BLOQUE Reemplaza: 27-628601, 27-62860, 27-37976</p>	<p>Pack. de 2</p>  <p>18-2503 18-2503-9① JUNTA PLATINA ESCAPE Reemplaza: 27-991771, 27-991772, 27-99177, 27-78068 V-6</p>	<p>Pack. de 2</p>  <p>18-2506-1 18-2506-1-9① JUNTA PLATINA ESCAPE Reemplaza: 27-991763, 27-991764, 27-991762, 27-99176 V-175/V-200</p>	<p>Pack. de 2</p>  <p>18-2508-1 18-2508-1-9① JUNTA PLATINA ESCAPE Reemplaza: 27-997761, 27-99776, 27-96440 V-135/V-150</p>
<p>Pack. de 2</p>  <p>18-2809 18-2809-9① JUNTA TAPA Reemplaza: 27-437792, 27-437791, 27-43779, 27-96485 50-60-HP</p>	<p>Pack. de 2</p>  <p>18-2511 18-2511-9① JUNTA PLATINA ESCAPE A ALOJAMIENTO Reemplaza: 27-99173-2 V-6</p>	<p>Pack. de 2</p>  <p>18-60919 JUNTA TAPA ESCAPE Reemplaza: 27-834952001 Para: Mercury 8/9.9 (R042475 & Sup)</p>	<p>Pack. de 2</p>  <p>18-2835 18-2835-9① JUNTA BASE BLOQUE Reemplaza: 27-692381, 27-69238, 27-66101, 27-64173, 27-60479 52-90-115-140 HP</p>	 <p>18-0982-1 JUNTA PLATINA BLOQUE Reemplaza: 27-56304, 27-48713</p>
 <p>18-60918 JUNTA BASE MOTOR Reemplaza: 27-835427003 Para: Mercury 8/9.9 (R042475 & Sup)</p>	<p>Pack. de 2</p>  <p>18-0182 18-0182-9① JUNTA TERMOSTATO Reemplaza: 27-62386</p>	 <p>18-0323 JUNTA TERMOSTATO Reemplaza: 27-14318-2, 27-14318 3</p>	 <p>18-0339 JUNTA TERMOSTATO Reemplaza: 27-43006-2, 27-430066 70-90 HP</p>	 <p>18-0835 JUNTA TERMOSTATO Reemplaza: 27-824853, 27-8248531 Para: Mercury 9.9-60 H.P., 4T</p>
<p>Pack. de 2</p>  <p>18-0914 JUNTA TERMOSTATO Reemplaza: 27-66847</p>	 <p>18-60920 JUNTA TERMOSTATO Reemplaza: 27-853702005 Para: Mercury 8/9.9 (R042475 & Sup)</p>	<p>Pack. de 2</p>  <p>18-0936 18-0936-9① JUNTA PLATINA VÁLVULA Reemplaza: 27-78690 V-6</p>	<p>Pack. de 2</p>  <p>18-0952 18-0952-9① JUNTA PLATINA VÁLVULA Reemplaza: 27-88907 V-6</p>	<p>Pack. de 2</p>  <p>18-2558 18-2558-9① JUNTA IMPULSOR Reemplaza: 27-19204-2 6/8/9/15</p>
 <p>18-0292 JUNTA PLATINA A ALOJAMIENTO BOMBA Reemplaza: 27-81417M</p>	<p>Pack. de 2</p>  <p>18-0294 18-0294-9① JUNTA PLATINA DESGASTE Reemplaza: 27-81421M</p>	<p>Pack. de 2</p>  <p>18-2559 18-2559-9① JUNTA IMPULSOR Reemplaza: 27-42206, 27-19202 6/8/9.9/15</p>	<p>Pack. de 2</p>  <p>18-2561 18-2561-9① JUNTA IMPULSOR Reemplaza: 27-85087 18/25 S/N 6443972 & inferior</p>	

① Precio por envase

<p>Pack. de 2</p>  <p>18-2564 18-2564-9① JUNTA IMPULSOR 70/75/80/90/100/115 Reemplaza: 27-430331, 27-43033</p>	<p>Pack. de 2</p>  <p>18-2565 18-2565-9 ① JUNTA IMPULSOR 70/75/80/90/100/115 Reemplaza: 27-430472, 27-430471, 27-43047</p>	<p>Pack. de 2</p>  <p>18-2566 18-2566-9 ① JUNTA IMPULSOR 75/90/100/115 Reemplaza: 27-817277, 27-8172771</p>	<p>Pack. de 2</p>  <p>18-2562 18-2562-9 ① JUNTA IMPULSOR 18/20/25 S/N 6443973 & superiores Reemplaza: 27-993261, 27-99326</p>
<p>Pack. de 2</p>  <p>18-2563 18-2563-9① JUNTA IMPULSOR 70/75/80/90/100/115 Reemplaza: 27-430341, 27-43034</p>	<p>Pack. de 2</p>  <p>18-2801 18-2801-9 ① JUNTA BOMBA DE AGUA Reemplaza: 27-32438 4-6 Cil.</p>	<p>Pack. de 2</p>  <p>18-2823 18-2823-9 ① JUNTA BOMBA DE AGUA INFERIOR Reemplaza: 27-32769, 27-19553 40-50-70 HP</p>	<p>Pack. de 2</p>  <p>18-2824 18-2824-9 ① JUNTA BOMBA DE AGUA SUPERIOR Reemplaza: 27-32770, 27-19551</p>
<p>Pack. de 2</p>  <p>18-2825 18-2825-9① JUNTA BASE BOMBA DE AGUA Reemplaza: 27-32771 40-50-70</p>	<p>Pack. de 2</p>  <p>18-2826 18-2826-9 ① JUNTA BASE BOMBA DE AGUA Reemplaza: 27-85610 1, 27-85670 4</p>	<p>Pack. de 2</p>  <p>18-2827 18-2827-9① JUNTA BOMBA DE AGUA SUPERIOR Reemplaza: 27-39623 20 HP</p>	<p>Pack. de 2</p>  <p>18-2828 18-2828-9 ① JUNTA BOMBA DE AGUA INFERIOR Reemplaza: 27-39625 20 HP</p>
 <p>18-0622 JUNTA PLATINA INFERIOR Reemplaza: 27-19701</p>	 <p>18-2593 JUNTA BOMBA DE AGUA Reemplaza: 27-194541 Para: 45 Jet, 50HP, 55HP, 60HP 3 cil fuerabordas</p>	 <p>18-0345 JUNTA BOMBA DE AGUA Reemplaza: 27-822189 Para: 25-60HP fuerabordas, 2, 3 cil. & 4 tiempos modelo</p>	<p>Pack. de 2</p>  <p>18-2841 18-2841-9 ① JUNTA BASE BOMBA DE AGUA Reemplaza: 27-77417, 27-19552</p>

<p>Pack. de 2</p>  <p>18-2914 18-2914-9① JUNTA BOMBA AGUA Reemplaza: 27-856081, 27-85608, 27-32433, 27-30603, 27-8M0090319</p>	<p>Pack. de 2</p>  <p>18-2915 18-2915-9① JUNTA BOMBA DE AGUA Reemplaza: 27-856091, 27-858524, 27-85609, 27-32434, 27-30604</p>	<p>Pack. de 2</p>  <p>18-2919 18-2919-9① JUNTA BOMBA DE AGUA Reemplaza: 27-426311, 27-42631</p>	
 <p>18-0514 RETÉN Reemplaza: 26-25329</p>	 <p>18-0521 RETÉN Reemplaza: 26-36557</p>	 <p>18-0539 RETÉN Reemplaza: 37721</p>	
 <p>18-0563 RETÉN Reemplaza: 26-36556</p>	<p>Pack. de 2</p>  <p>18-2560 18-2560-9① JUNTA IMPULSOR Reemplaza: 12-86645, 12-866451, 8M0027721 18/20/25</p>	<p>Pack. de 5</p>  <p>18-2430 18-2430-9① 18-24301-9① (PACK. DE 50) JUNTA Reemplaza: 26-830749 Para: Todos los Verado</p>	
 <p>18-2728 RETÉN TUBO DE AGUA Reemplaza: 26-42102, 26-421021</p>	<p>Pack. de 2</p>  <p>18-2945 18-2945-9① RETÉN DRENAJE Reemplaza: 12-20260, 12-19183, 12-191832, 191833, F50556, F8077, F8186 Usado en la mayoría de las unidades inferiores y bombas de agua marina</p>	<p>Pack. de 2</p>  <p>18-2948 18-2948-9① ARANDELA GOMA Reemplaza: 12-492211, 12-49221, 12-23245 Para ventilación tanque depósito y otros usos</p>	<p>Pack. de 2</p>  <p>18-4858-9① ARANDELA Reemplaza: 12-45176 Para: Mercury fueraborda 25 H.P. y Sup, Mercuriser #1, R, MR, Alpha I Gen II y Bravo</p>

 <p>18-4261 ARANDELA Reemplaza: 19643</p>	<p>Pack. de 4</p>  <p>18-0568-9③ CASQUILLO Reemplaza: 23-43045</p>	 <p>18-8305 JUNTA RETÉN DIVISOR Reemplaza: 26-814754, 428381, 42838, 69668, 88726</p>
 <p>18-8309 JUNTA RETÉN REGULA-DOR DE AGUA Reemplaza: 18717</p>	 <p>18-4698 18-46981-9③ (Pack. de 50) ARANDELA LLENADO/VACIADO Reemplaza: 27-81987, 27-81987M</p>	 <p>18-4275 ARANDELA Reemplaza: 12-29245, 12-824793, 12-38753, 12-32733, 12-25945, 12-22388</p>
 <p>18-4915 CUERDA DE ARRANQUE Reemplaza: 50-12066A9, 50-12066Q9, 50-45093, 50-28985A2, 50-22791A1, 50-12066A1</p>	 <p>18-6506 MUELLE DE ARRANQUE Reemplaza: 24-29340A1, T1</p>	

APLICACIONES MUELLES ARRANQUE

Modelo/HP	Desde Nº de serie	Hasta Nº de serie	Muelle arranque	Modelo/HP	Desde Nº de serie	Hasta Nº de serie	Muelle arranque
Merc 4	2498136	4107219	18-6506	Merc 35	1217222	1271884	18-6506
Merc 4.5	4107220	& Sup	18-6506	Merc 35	1356948	1448139	18-6506
Merc 6	1408611	2387383	18-6506	Merc 35	1571114	1960826	18-6506
Merc 7.5	2529895	& Sup	18-6506	Merc 35	1960827	2097279	—
Mar 8	M-677-000101	& Sup	—	Merc 35	2097832	2258863	—
Merc 9.8	Todos		18-6506	Merc 35	2300962	2453068	—
Mar 9.9	M-682-000551	M-682-032885	—	Merc 35	2487558	2874703	—
Mark (10) 10	Todos		18-6506	Merc 35	6445653	& Sup	—
Merc 10	1290910	1455239	18-6506	Mark (55) 40	831021	& Sup	18-6506
Mark (15) 15	Todos		18-6506	Merc 40	1279685	1476509	18-6506
Merc 15	1288910	1349697	18-6506	Mar 40	Todos		—
Mar 15	M-684-000101	& Sup	—	Merc 40	2874704	3336257	—
Merc 20	3537531	6443972	18-6506	Merc 40	3326258	& Sup	—
Merc 20	1292910	3537530	18-6506	Merc 40	C159200	& Sup	—
Mar 20	M-653-07615	& Inferior	—	Mark (58) 45	1139538	& Sup	18-6506
Mar 20	M-653-07616	& Sup	—	Merc 45	1476510	1531568	18-6506
Mar 20	M-6A9-000101	& Sup	—	Merc 50	1421113	2116317	18-6506
Mark (28) 22	Todos		18-6506	Merc 50	5531630	& Sup	—②
Merc 25	1467499	1499331	18-6506	Merc 50	1770179	& Sup	—
Mar 25	M-648-19025	& Inferior	& Inferior	Mark (75) 60	Todos		18-6506
Mar 25	M-695-000101	& Sup	& Sup	Merc 60	Todos		18-6506
Mar 28	Todos		—	Merc 65	1542745	1765043	18-6506
Merc 30	1271885	1356947	18-6506	Mark (78) 70	Todos		18-6506
Mar 30	Todos		18-6521	Merc 70	Todos		18-6506

① Por encima escape ② Sólo 4 cil

③ Precio por envase

Introducing

SONAR **PRO**

SIERRA ONLINE APPLICATION RESOURCE



Login to: <http://sonar.seastarsolutions.com>

SONAR PRO FEATURES INCLUDE

- Parts Interchange
- Parts Category Search
- Model Search
- New Products
- Diagrams & Exploded Views
- Search Parts By Keyword
- Send Us Your Feedback
- Warranty Tracker
- Free

www.seastarsolutions.com

35 & 40 2 Cilindros

Serie # 2736807-G053313

50, 60, 65 3 Cilindros

Serie # 3293184-D000749

70 3 Cilindros

Serie # 4571652-6428680

40, 45, 50 4 Cilindros

Serie # 4357640 y posteriores

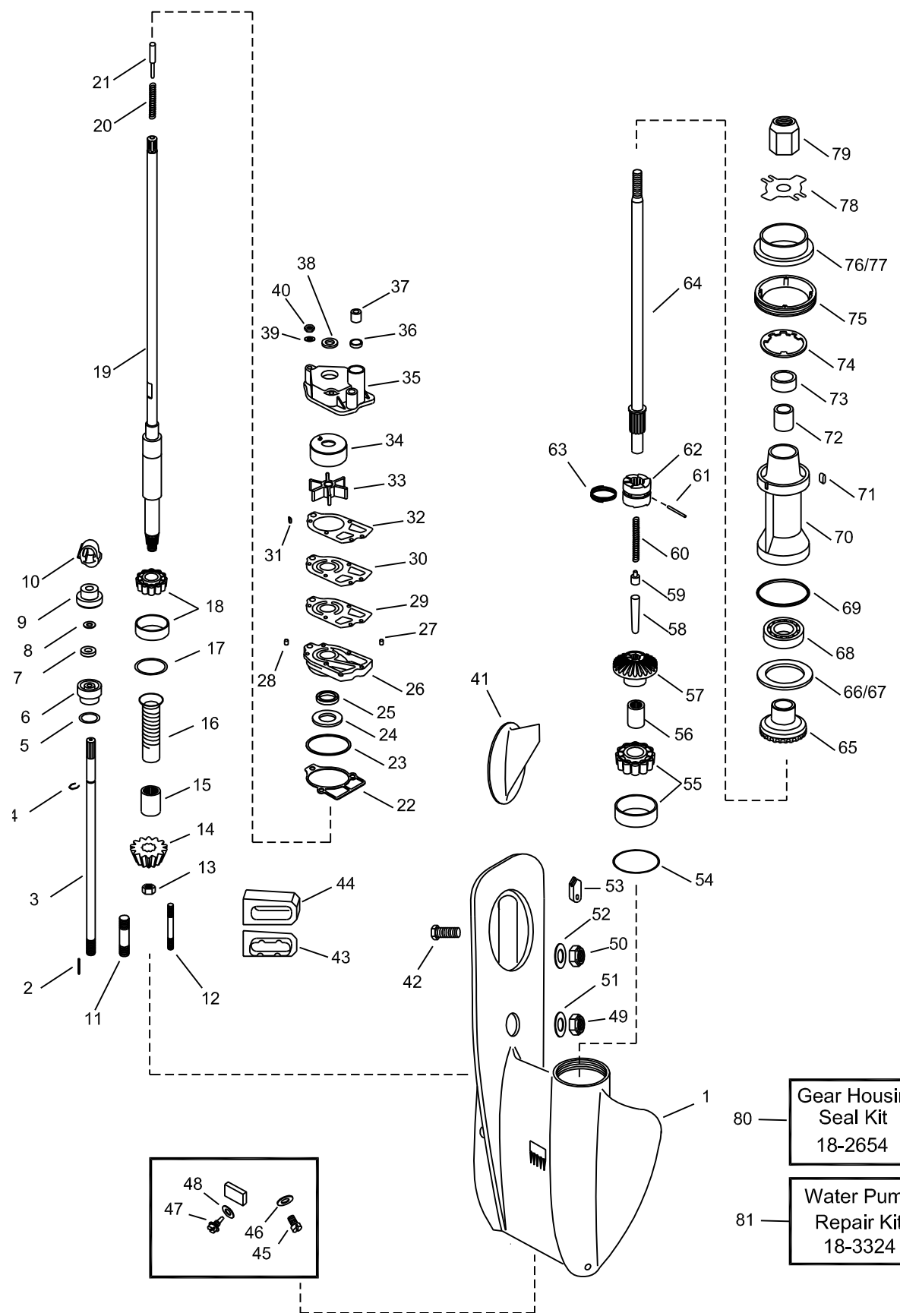

80 — Gear Housing Seal Kit 18-2654

81 — Water Pump Repair Kit 18-3324

Figura #	Descripción	Ref #	O.E.M. #	Cant.	Figura #	Descripción	Ref #	O.E.M. #	Cant.
1	Alojamiento	—	1643-9539A1	1	48	Arandela	18-2948	12-492211	1
2	Pasador	—	17-85500	2	49	Tuerca	18-2361	11-34933	1
3	Eje dirección	—	76163A1	1	50	Tuerca	—	1134863	1
4	Clip	18-4295	53-29641	1	51	Arandela	—	12-65791	1
5	Aro	18-7153	25-21836	1	52	Arandela	—	12-45175	1
6	Casquillo	18-2155	23-77631A2	1	53	Pasador cambio	—	76039	1
7	Retén	18-2054	26-816461	1	54	Set aros	—	15-38374A1	AR
8	Arandela	18-2316	12-77674	1	55	Cojinete	18-1162	31-38356A1	1
9	Base reserva	—	78036	1	56	Cojinete	18-1096	31-21739	1
10	Cierre reverso	—	433081	1	57	Engranaje de avance	—	43-55608A4	1
11	Pivote	—	16-33778	3	58	Pasador	—	38441	1
12	Pivote	—	16-57933	2	59	Deslizador	—	20843	1
13	Tuerca piñon	—	11-55910	1	60	Muelle	—	24-38114	1
14	Engranaje piñon	—	43-98097	1	61	Pasador	—	17-38113	1
15	Cojinete	—	31-62091	1	62	Alojamiento	—	52-92911	1
16	Tornillo	—	88181	1	63	Muelle	—	24-39845	1
17	Set aros	—	15-92881A1	AR	64	Eje dirección	—	44-75365	1
18	Cojinete	—	31-77420A1	1	65	Engranaje reverso	—	43-79158	1
19	Eje dirección	—	45-981801	1	66	Arandela empuje	—	12-32004	1
20	Muelle	—	24-20254	1	67	Set aros	—	15-20927A1	AR
21	Pasador	—	17-30545	1	68	Cojinete	18-1190	30-20839T	1
22	Junta	18-2841	27-19552	1	69	Aro	18-7160	2531986	1
23	Aro	18-7115	25-26722	1	70	SopORTE cojinete	—	69386A1	1
24	Retén	18-2055	26-79831	1	71	Llave	—	28-30281	1
25	Retén	18-2011	26-90562	1	72	Cojinete	—	3121700	1
26	Base bomba de agua	18-3424	46-77177A1	1	73	Retenes	18-2051, 18-2052	26-69188, 26-619189	1
27 & 28	Pasador	—	17-35973	1	74	Arandela	—	14-53012	1
29	Junta	18-2823	27-19553	1	75	Tuerca tapa	—	11-87763	1
30	Platina	18-3107	54705	1	76	Núcleo de empuje	18-4233	73345A1	1
31	Llave	—	28-56662	1	77	Núcleo empuje	18-3204	14-76281	1
32	Junta	18-2824	27-19551	1	78	Núcleo empuje	18-3204	14-76281	1
33	Impulsor	18-3007	47-89983	1	79	Tuerca	18-3702	11-69578A	1
34	Aro pasante	18-3115	48753	1	80	Kit retén alojamiento	18-2654	26-79831A1	1
35	Cuerpo bomba de agua	18-3118	46-77822A1	1	81	Kit reparación bomba de agua	18-3324	46-77177A3	1
36	Arandela	—	12-38453	1					
37	Retén	—	26-38452	1					
38	Tuerca	—	25-20273	1					
39	Arandela	18-4275	12-29245	3					
40	Tuerca	—	11-13438	3					
41	Anodo zinc	009354	31640A1	1					
42	Tornillo	—	10-66024	1					
43	SopORTE platina	—	92815	1					
44	Retén tubo de salida	18-0539	37721	1					
45	Tapón drenaje	18-2244	10-79953	2					
46	Arandela	18-2945	12-19183	2					
47	Tapón	—	19-48750	1					

AR Se requiere

70, 75, 80, 90

Serie # A996142 y posterior

100, 115, 125 4 Cilindros

Serie # B209468 y posterior

- 68 — Gear Housing Seal Kit 18-2626
- 69 — Water Pump Repair Kit 18-3214



Figura #	Descripción	Ref #	O.E.M. #	Cant.	Figura #	Descripción	Ref #	O.E.M. #	Cant.
1	Alojamiento	—	1667-9011A73	1	49	Muelle	—	24-30622	1
2	Tornillo	—	10-8248327	4	50	Embrague	18-2236	52-822539	1
3	Arandela	18-4275	12-29245	4	51	Pasador	18-2357	17-30632	1
4	Aislador	18-0568	23-43045	4	52	Muelle	18-2348	24-30893	1
5	Aloj. bomba agua	18-3572	817275A2	1	53	Eje dirección	—	44-12238T	1
6	Impulsor	18-3056	47-430262	1	54	Engranaje reverso	—	43-12635	1
7	Impulsor llave	18-3293	28-43037	1	55	Aro	18-7961	25-97386	1
8	Junta	18-2566	27-817277	1	56	Cojinete	18-1112	31-12576	1
9	Platina	18-3122	817276	1	57	Arandela empuje	18-1191	12-12577	1
10	Junta	18-2564	27-430331	1	58	Cojinete	18-1113	31-12578	1
11	tornillo	—	10-824832-6	6	59	SopORTE cojinete	—	12596A2	1
12	Arandela	18-4275	12-29245	6	60	Arandela	—	12-70132	2
13	base bomba	—	43055A4	1	61	Tuerca	—	11-401198	2
14	Retén	18-0583	26-43035	1	62	Cojinete	18-1158	31-30956	1
15	Retén	18-0522	26-43036	1	63	Retén	18-2002	26-76868	1
16	Junta	18-2565	27-430472	1	64	Retén	18-2053	26-70081	1
17	Eje	—	43040A1	1	65	Arandela empuje	18-4221	13191A1	1
18	Tornillo	—	43046	1	66	Arandela	18-3200	14-31210	1
19	Alojamiento	—	42461A1	1	67	Tuerca hélice	18-3700	11-52707	1
20	Alojamiento	—	42461A1	1					
21	Eje dirección	—	45-43031A1	1					
22	Aro	—	15-44492A1	AR					
23	Cojinete (Se vende con #24)	18-1118	31-42677A1	1					
24	Cojinete (Se vende con #23)	18-1118	31-42677A1	1					
25	Piñon engranaje	—	43-44484	1					
26	Tuerca piñon	18-3719	11-35921	1					
27	Retén	18-2054	26-8164641	1					
28	Alojamiento	—	23-43052A4	1					
29	Tornillo	—	10-824832-6	2					
30	Aro	18-7198	25-45710	1					
31	Aro	18-4295	53-29641	1					
32	Eje	—	43048A1	1					
33	Junta	18-2945	12-19183	3					
34	Tapón	—	10-28653	1					
35	Tapón	18-2244	10-79953	1					
36	Tapón	18-2375	22-67892A1	1					
37	Anodo zinc	18-6011	31640A1	1					
38	Tornillo montaje ánodo	18-6245	10-15942	1					
39	Arandela, montaje ánodo	18-4858-9	12-45176	1					
40	Leva	—	76039	1					
41	Arandela	—	15-44491A1	AR					
42 & 43	Cojinete	18-1156	13-30894A1	1					
44	Cojinete	18-1157	31-30895	1					
45	Engranaje avante	—	43-12634A2	1					
46 & 47	Pasador	—	12239A1	1					
48	Cojiente	—	30-44530	3					

AR Se requiere

V-150

Serie # A904645 y anteriores

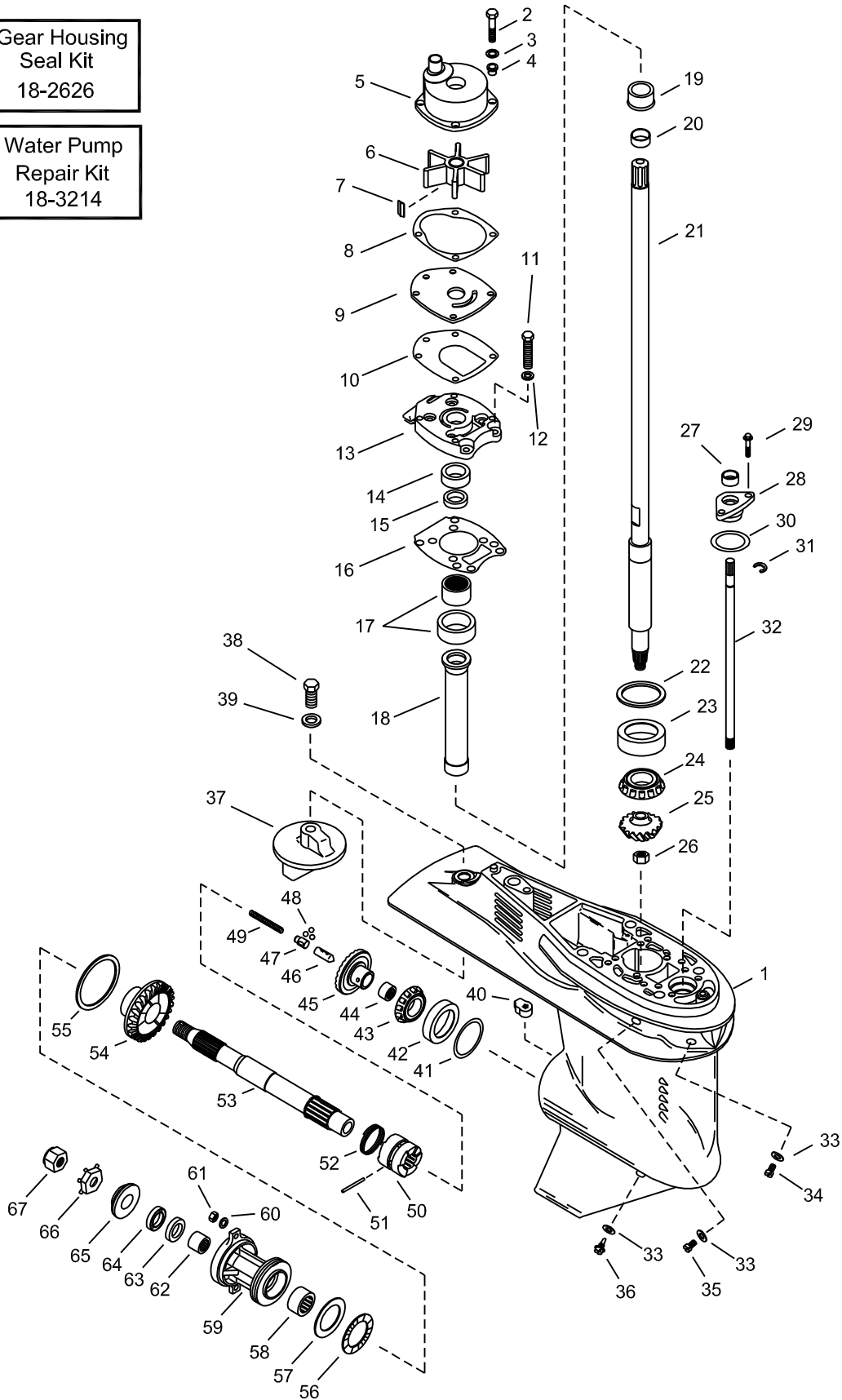
V-175

Serie # 6648750 y anteriores

V-200

Serie # 6625220 y anteriores

Gear Housing
Seal Kit
18-2653

Water Pump
Repair Kit
(with housing)
18-3217

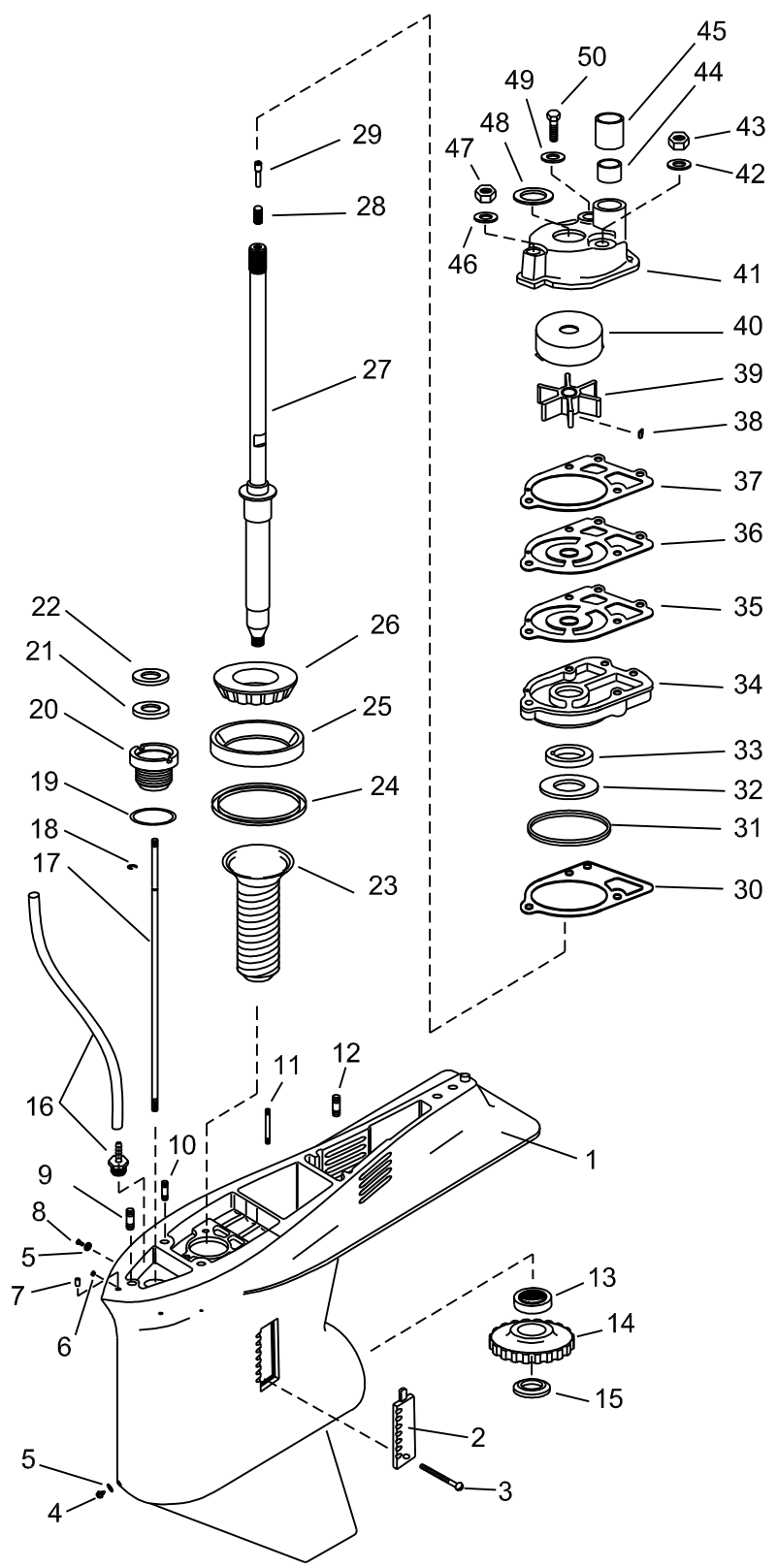

Listado completo de engranajes en la página 431



Figura #	Descripción	Ref #	O.E.M. #	Cant.
34	Base bomba de agua	18-3416	46-96146A6	1
35	Junta	18-2914	27-856081	1
36	Platina	18-3117	32435	1
37	Junta	18-2915	27-856091	1
38	Llave	~	28-56654	1
39	Impulsor	18-3017	47-899842	1
40	Aro pasante	18-3114	48752	1
41	Cuerpo bomba de agua	18-3116	43-96148A1	1
42	Arandela	18-4275	12-29245	3
43	Tuerca	18-3722	11-20361	2
44	Retén	18-3110	26-38970	1
45	Guía	18-3109	23-29804	1
46	Arandela	18-4270	12-36001	1
47	Aro	18-3722	11-45592	1
48	Aro	18-7426	25-30271	1
49	Arandela	18-4275	12-29245	3
50	Tornillo	~	10-96411	1
51	Ánodo Trim.	009354	3164A1	1
52	Tornillo	~	10-66024	1
53	Pasador cambio	~	78956	1
54	Tuerca	18-3721	11-34933	1
55	Arandela	~	12-45176	2
56	Tornillo	~	10-65210	1
57	Pasador	~	89594A1	1
58	Actuador	~	79911 1	1
59	Pasador	~	17-78906	1
60	Muelle	~	24-749910	2
61	Arandela	~	12-78910	1
62	Arandela	18-2285	15-47397A1	AR
63	Cojinete	18-1166	31-78172A1	1
64	Engranaje de avance	~	43-78082A3	1
65	Cojinete	18-1122	31-73363	2
66	Embrague	~	52-823174	1
67	Pasador	~	17-78909	2
68	Pasador	~	17-78905	1
69	Muelle	~	24-78962	2
70	Eje dirección	18-2239	44-94148	1
71	Engranaje reverso	~	43-85462	1
72	Aro	~	68100 1	1
73	Cojinete	18-1155	30-88957	1
74	Aro	18-7159	25-31534	1
75	Cojinete soporte	18-1567	43567T1	1
76	Llave	~	28-30281	1
77	Cojinete	18-1158	31-30956	1
78	Retén (Int)	18-2002	26-76868	1
79	Retén (Ext)	18-2053	26-70081	1
80	Arandela	18-2299	14-79447	1
81	Tuerca tapa	18-3751	79448	1
82	Núcleo empuje	18-4220	13171	1
83	Arandela	18-3714	12-31211A2	1
84	Arandela	18-3200	14-31210	1
85	Tuerca hélice	18-3700	11-52707	1

Figura #	Descripción	Ref #	O.E.M. #	Cant.
1	Alojamiento	~	1647-9148A65	1
2	Rejilla de agua (Estribor)	~	66885	1
	Rejilla de agua (Babor)	~	66884	1
3	Tornillo	18-3197	10-76156	1
4	Tornillo drenaje	18-2375	22-67892A1	1
5	Arandela	18-2945	12-19183	2
6	Tuerca	18-2344	11-45812	1
7	Pasador	~	17-43044	2
8	Tornillo ventilación	18-2244	10-79953	1
9	Pivote	~	16-78638	1
10	Pivote	~	16-56297	1
11	Pivote	~	16-30667	2
12	Pivote	~	16-579201	2
13	Cojinete	~	31-35934A1	1
14	Piñon engranaje	~	43-780811	1
15	Tuerca piñon	18-3719	11-35921	1
16	Tubo velocímetro	~	22-85822A10	1
17	Eje dirección	~	78902 2	1
18	Clip	18-4295	53-29641	1
19	Aro	18-7153	25-21836	1
20	Casquillo	18-2155	23-77631A2	1
21	Retén	18-2054	26-816461	1
22	Arandela goma	18-2316	12-77674	1
23	Tornillo	~	23-98621	1
24	Arandela	18-2295	15-57007A1	AR
25	Cojinete	18-1164	31-53079A1	1
26	Cojinete	18-1164	31-53079A1	1
27	Eje dirección	~	45-98682A1	1
28	Muelle	~	24-34576	1
29	Pasador	~	17-30545	1
30	Junta	18-2826	27-856101	1
31	Aro	18-7162	25-33145	1
32	Retén	18-2014	26-89238	1
33	Retén	18-2013	26-16977	1

AR Se requiere

 <p>18-1190 COJINETE A BOLAS Reemplaza: 30-20839T, 30-20839, 30-62699, FI000034 Para engranaje reverso Force, Mercury, Mariner de 25-60HP (2, 3 cilindros, & 4-tiempos) incluye 30Jet - 45Jet</p>	 <p>18-1191 ARANDELA EMPUJE Reemplaza: 12-12577 30-125HP</p>	 <p>18-1112 COJINETE DE EMPUJE EN-GRANAJE REVERSO Reemplaza: 31-12576</p>	 <p>18-1113 COJINETE ENGRANAJE RE-VERSO Reemplaza: 31-12578, 31-12578T</p>
 <p>18-1115 COJINETE PIÑON AVANTE INT. Reemplaza: 31-32898, 31-32898T, 31-29982</p>	 <p>18-1117 COJINETE PIÑON Reemplaza: 31-42647A1, 31-42647, 31-F694057</p>	 <p>18-1118 COJINETE PIÑON Reemplaza: 31-42677A1</p>	
 <p>18-1122 COJINETE INTERIOR EN-GRANAJE AVANTE Reemplaza: 31-73363, 31-73363T</p>	 <p>18-1143 COJINETE CÓNICO Reemplaza: 31-36387A1</p>	 <p>18-1144 ENSAMBLAJE COJINETE Reemplaza: 31-48939A2</p>	 <p>18-1153 COJINETE A BOLAS Reemplaza: 30-63326, 30-63326T, 30-49313, 30-54215, 30-20464</p>
 <p>18-1154 COJINETE A BOLAS Reemplaza: 30-63742, 30-63742T</p>	 <p>18-1155 COJINETE A BOLA Reemplaza: 30-88957A1, 30-88957T, 30-35914, 30-17927, 30-89957</p>	 <p>18-1197 COJINETE CÓNICO Reemplaza: 31-828439A2 1.5625 D.I. Para: Mercury/Mariner 200 (3.0L DFI), 225 (3.0L Carb), 225/250 (3.0L EFI) S/N G437999 & inferior</p>	 <p>18-1156 COJINETE RODILLO Reemplaza: 31-30894A1</p>
 <p>18-1157 COJINETE AGUJAS Reemplaza: 31-30895, 31-30895T</p>	 <p>18-1158 COJINETE DE AGUJAS Reemplaza: 31-30956, 31-30956T, 31-F523058</p>	 <p>18-1159 COJINETE RODILLOS Reemplaza: 31-35928A1, 31-35928T1</p>	 <p>18-1162 COJINETE RODILLOS Reemplaza: 31-38356A1, 31-F84901, F84901, F84903</p>

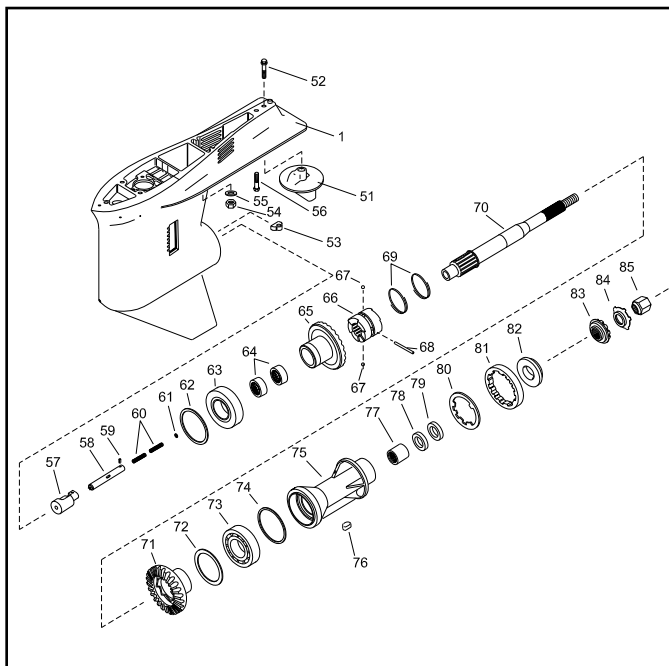
APLICACIONES EMPIEZAN EN LA PRÓXIMA PÁGINA



18-1164
COJINETE RODILLOS
Reemplaza: 31-53079A1, 31-53079

18-1166
COJINETE RODILLOS
Reemplaza: 31-78172A1

18-1170
COJINETE PIÑÓN INFERIOR
Reemplaza: 31-812767A1



18-0557
RETÉN INFERIOR
Reemplaza: 888909A1
Para: Todos Verado
135/150/175/200/225/250/275



18-1567
RODILLO DIÁBOLO
Reemplaza: 43567T1, 43567A1, 96184A1
Para: V-115 DFI 2.5L (2000), V-135 (1986 & Sup), V-135 DFI 2.5L (1998 & Sup), V-150 (1978 & Sup), V-150 EFI (1996-01), V-150 DFI 2.5L (1998 & Sup), V-175 (1976-99), V-175 EFI (1996-01), V-175 DFI 2.5L (2001 & Sup), V-200 (1978 & Sup), V-200 EFI (1989-01), V-200 EFI 2.5L (2002 & Sup), XR-6 (1992-99)



18-2370
RODILLO DIÁBOLO
Reemplaza: 19291A3
(Force 40/50 HP 1995-99, 70 HP 1991-95, 75 HP 1996-98)
(Mercury/Mariner 30/40 HP 2 cil 9854537-P016999, 30/40 4-tiempos G760300-sup, 40/50 HP/30Jet 3 cil 9973100-sup, 60 HP 3 cil D000750-sup, 60 HP 4-tiempos 9973100-sup)

Modelo	Número de serie	Cojinete (Eje transmisión)	Cojinete piñón	Cojinete interior marcha avante	Cojinete externo Marcha avante	Cojinete Marcha atrás	Cojinete empuje Marcha atrás	Cojinete Agujas
30 (4-tiempos, Bigfoot)	G760300 & Sup	18-1118	—	18-1157	18-1156	18-1113	18-1112	18-1158
30 (4-tiempos, no-Bigfoot)	G760300 & Sup	—	—	—	18-1107	—	—	—
30 EFI (4-tiempos, Bigfoot)	T409000 & Sup	18-1118	—	18-1157	18-1156	18-1113	18-1112	18-1158
30 EFI (4-tiempos, no-Bigfoot)	T409000 & Sup	—	—	—	18-1107	—	—	—
35 (2 cil.)	6445653 & Sup	—	—	—	18-1162	—	N/D	—
350	1960827 - 2874703	—	—	18-1162	—	N/D	—	—
400 (2 cil.)	2874704 - 3336257	—	—	—	18-1162	—	N/D	—
402	3336258 - 4117709	—	—	—	18-1162	—	N/D	—
402	4117710 - 4860102	—	—	—	18-1162	—	N/D	—
402/40 (2 cil.)	4860103 - 5556229	—	—	—	18-1162	—	N/D	—
40 (2 cil.)	5556230 - G053313	—	—	—	18-1162	—	N/D	—
40 (4 cil.)	C159200 & Sup	—	—	—	18-1162	—	N/D	—
40 (4-tiempos, Bigfoot)	G231123 & Sup	18-1118	—	18-1157	18-1156	18-1113	18-1112	18-1158
40 (4-tiempos, no-Bigfoot)	G231123 & Sup	—	—	—	18-1107	—	—	—
40 (4-tiempos, 4 cil. Bigfoot)	T228405 & Sup	18-1118	—	18-1157	18-1156	18-1113	18-1112	18-1158
40 (4-tiempos, 4 cil. no-Bigfoot)	T228405 & Sup	—	—	—	18-1170	—	—	—
40 EFI (4-tiempos, 3 cil. no-Bigfoot)	T409000 & Sup	—	—	—	18-1103	18-1190	—	—
40 EFI (4-tiempos, 3 cil. Bigfoot)	T409000 & Sup	18-1118	—	18-1157	18-1156	18-1113	18-1112	18-1158
40 EFI (4-tiempos, 4 cil. no-Bigfoot)	T409000 & Sup	—	—	—	18-1170	—	—	—
45 (4 cil.)	5531630 & Sup	—	—	—	18-1162	—	N/D	—
45 (Bodensee 4-tiempos, Bigfoot)	G231123 - T178499	18-1118	—	18-1157	18-1156	18-1113	18-1112	18-1158
45 (Bodensee 4-tiempos, no-Bigfoot)	G231123 - T178499	—	—	—	18-1103	—	—	—
500	2305101 - 2858813	—	—	—	18-1162	—	N/D	—
500	2858814 - 4140999	—	—	—	18-1162	—	N/D	—
500	4141000 - 4357639	—	—	—	18-1162	—	N/D	—
500 / 50	4357640 - 4962055	—	—	—	18-1162	—	N/D	—
500 / 50	4962056 - 5531629	—	—	—	18-1162	—	N/D	—
50 (4 cil.)	5531630 & Sup	—	—	—	18-1162	—	N/D	—
50 (3 cil.)	6428681 - D000749	—	—	—	18-1162	—	N/D	—
50 (3 cil.)	D000750 - G589999	—	—	—	18-1170	—	N/D	—
50 (4-tiempos, Bigfoot)	G231123 & Sup	18-1118	—	18-1157	18-1156	18-1113	18-1112	18-1158
50 (4-tiempos, no-Bigfoot)	G231123 & Sup	—	—	—	18-1107	—	—	—

- ① Sólo rotación standar.
- ② Necesita 2 cojinetes.
- ③ Para unidades con número 1655-9572C.
- ④ Para unidades con número 1674-814247C.
- ⑤ Necesita 2 cojinetes.
- ⑥ Para 5/8 Cojinete doble.
- ⑦ Use 18-1155 para aplicaciones contra-rotación.

Modelo	Número de serie	Cojinete (Eje transmisión)	Cojinete Piñón	Cojinete interior Marcha avante	Cojinete exterior Marcha avante	Cojinete marcha atrás	Cojinete empuje Marcha atrás	Cojinete Agujas
30 (4-tiempos, Bigfoot)	G760300 & Sup	18-1118	—	18-1157	18-1156	18-1113	18-1112	18-1158
30 (4-tiempos, no-Bigfoot)	G760300 & Sup	—	—	—	18-1107	—	—	—
30 EFI (4-tiempos, Bigfoot)	T409000 & Sup	18-1118	—	18-1157	18-1156	18-1113	18-1112	18-1158
30 EFI (4-tiempos, no-Bigfoot)	T409000 & Sup	—	—	—	18-1107	—	—	—
35 (2 cil.)	6445653 & Sup	—	—	—	18-1162	—	N/D	—
350	1960827 - 2874703	—	—	18-1162	—	N/D	—	—
400 (2 cil.)	2874704 - 3336257	—	—	—	18-1162	—	N/D	—
402	3336258 - 4117709	—	—	—	18-1162	—	N/D	—
402	4117710 - 4860102	—	—	—	18-1162	—	N/D	—
402/40 (2 cil.)	4860103 - 5556229	—	—	—	18-1162	—	N/D	—
40 (2 cil.)	5556230 - G053313	—	—	—	18-1162	—	N/D	—
40 (4 cil.)	C159200 & Sup	—	—	—	18-1162	—	N/D	—
40 (4-tiempos, Bigfoot)	G231123 & Sup	18-1118	—	18-1157	18-1156	18-1113	18-1112	18-1158
40 (4-tiempos, no-Bigfoot)	G231123 & Sup	—	—	—	18-1107	—	—	—
40 (4-tiempos, 4 cil. Bigfoot)	T228405 & Sup	18-1118	—	18-1157	18-1156	18-1113	18-1112	18-1158
40 (4-tiempos, 4 cil. no-Bigfoot)	T228405 & Sup	—	—	—	18-1170	—	—	—
40 EFI (4-tiempos, 3 cil. no-Bigfoot)	T409000 & Sup	—	—	—	18-1103	18-1190	—	—
40 EFI (4-tiempos, 3 cil. Bigfoot)	T409000 & Sup	18-1118	—	18-1157	18-1156	18-1113	18-1112	18-1158
40 EFI (4-tiempos, 4 cil. no-Bigfoot)	T409000 & Sup	—	—	—	18-1170	—	—	—
45 (4 cil.)	5531630 & Sup	—	—	—	18-1162	—	N/D	—
45 (Bodensee 4-tiempos, Bigfoot)	G231123 - T178499	18-1118	—	18-1157	18-1156	18-1113	18-1112	18-1158
45 (Bodensee 4-tiempos, no-Bigfoot)	G231123 - T178499	—	—	—	18-1103	—	—	—
500	2305101 - 2858813	—	—	—	18-1162	—	N/D	—
500	2858814 - 4140999	—	—	—	18-1162	—	N/D	—
500	4141000 - 4357639	—	—	—	18-1162	—	N/D	—
500 / 50	4357640 - 4962055	—	—	—	18-1162	—	N/D	—
500 / 50	4962056 - 5531629	—	—	—	18-1162	—	N/D	—
50 (4 cil.)	5531630 & Sup	—	—	—	18-1162	—	N/D	—
50 (3 cil.)	6428681 - D000749	—	—	—	18-1162	—	N/D	—
50 (3 cil.)	D000750 - G589999	—	—	—	18-1170	—	N/D	—
50 (4-tiempos, Bigfoot)	G231123 & Sup	18-1118	—	18-1157	18-1156	18-1113	18-1112	18-1158
50 (4-tiempos, no-Bigfoot)	G231123 & Sup	—	—	—	18-1107	—	—	—
50 EFI (4-tiempos, no-Bigfoot)	T409000 & Sup	—	—	—	18-1107	—	—	—
50 EFI (4-tiempos, Bigfoot)	T409000 & Sup	18-1118	—	18-1157	18-1156	18-1113	18-1112	18-1158
55 (3 cil.)	D000750 - G589999	—	—	—	18-1170	—	N/D	—
55 Seapro, Marathon, Pontoon	D000750 & Sup	18-1118	—	18-1157	18-1156	18-1113	18-1112	18-1158
60 (3 cil.)	6428681 - D000749	—	—	—	18-1162	—	N/D	—
60 (3 cil.)	D000750 - G589999	—	—	—	18-1170	—	N/D	—
60 EFI (4-tiempos, no-Bigfoot)	T409000 & Sup	—	—	—	18-1103	—	—	—
60 EFI (4-tiempos, Bigfoot)	T409000 & Sup	18-1118	—	18-1157	18-1156	18-1113	18-1112	18-1158
650 (4 cil.)	1542745 - 1765403	18-1153	—	18-1157	18-1156	—	N/D	18-1158
650 (4 cil.)	2119749 - 2309310	18-1153	—	18-1157	18-1156	—	N/D	18-1158
650 (4 cil.)	2309311 - 2452709	18-1153	—	18-1157	18-1156	—	N/D	18-1158
650 (4 cil.)	2503991 - 2803561	18-1153	—	18-1157	18-1156	—	N/D	18-1158
650 (4 cil.)	2803562 - 2874263	—	—	18-1157	18-1156	—	N/D	18-1158
650 (4 cil.)	2997339 & Sup	—	—	18-1157	18-1156	—	N/D	18-1158
650 (3 cil.)	3293184 - 3525440	—	—	—	18-1162	—	N/D	—
650 (3 cil.)	3547987 - 4571651	—	—	—	18-1162	—	N/D	—
70 (3 cil.)	4571652 - 4977156	—	—	—	18-1162	—	N/D	—
70 (3 cil.)	4977157 - 5579016	—	—	—	18-1162	—	N/D	—
70 (3 cil.)	5579017 - 6428680	—	—	—	18-1162	—	N/D	—
70 (3 cil.)	A996142 - & Sup	18-1118	N/D	18-1157	18-1156	18-1113	18-1112	18-1158
75 (4 cil.)	6432901 & Sup	—	—	18-1157	18-1156	N/D	N/D	18-1158
75 (3 cil.)	A996142 - & Sup	18-1118	N/D	18-1157	18-1156	18-1113	18-1112	18-1158
800 (4 cil.)	2559001 - 3144218	18-1153	—	18-1157	18-1156	—	N/D	18-1158
800 (4 cil.)	3144219 - 3493912	—	—	18-1157	18-1156	—	N/D	18-1158
80 (4 cil.)	4831999 - 6432900	—	—	18-1157	18-1156	N/D	N/D	18-1158
80 (3 cil.)	A996142 & Sup	18-1118	N/D	18-1157	18-1156	18-1113	18-1112	18-1158
850 (4 cil.)	3493913 - 4831998	—	—	18-1157	18-1156	—	N/D	18-1158
900 (6 cil.)	1766824 - 1869775	18-1153	—	18-1157	18-1156	—	N/D	18-1158
900/90 (6 cil.)	4845301 - & Sup	—	—	18-1157	18-1156	N/D	N/D	18-1158
90 (3 cil.)	A996142 & Sup	18-1118	N/D	18-1157	18-1156	18-1113	18-1112	18-1158

① Sólo rotación standar.

③ Para unidades con número 1655-9572C.

④ Para unidades con número 1674-814247C.

⑤ Necesita dos cojinetes.

⑥ Para 5/8 cojinete doble.

⑦ Use 18-1155 para aplicaciones contra-rotación.

⑧ Usar piñón 43-19672.

Modelo	Número de serie	Cojinete (eje transmisión)	Cojinete piñón	Cojinete inferior Marcha adelante	Cojinete externo Marcha adelante	Cojinete marcha atrás	Cojinete empuje marcha atrás	Cojinete Agujas
100 (4 cil.)	B209468 - & Sup	18-1118	N/D	18-1157	18-1156	18-1113	18-1112	18-1158
1150	2836019 - 2933900	18-1153	—	18-1157	18-1156	—	N/D	18-1158
1150	2933901 - 3525440	18-1153	—	18-1157	18-1156	—	N/D	18-1158
1150	3525441 - 4112634	18-1153	—	18-1157	18-1156	—	N/D	18-1158
1150	4112635 - 4855152	—	—	18-1157	18-1156	—	N/D	18-1158
1150 / 115	4855153 - 5314655	—	—	18-1157	18-1156	N/D	N/D	18-1158
115 (6 cil.)	5314656 - 5600966	—	—	18-1157	18-1156	N/D	N/D	18-1158
115 (6 cil.)	5600967 - 6436122	—	—	18-1157	18-1156	N/D	N/D	18-1158
115 (6 cil.)	6436123 & Sup	—	—	18-1157	18-1156	N/D	N/D	18-1158
115 (4 cil.)	C100000 & Sup	18-1118	N/D	18-1157	18-1156	18-1113	18-1112	18-1158
125 (4 cil.)	0T627234 & inferior Ⓣ	18-1118	N/D	18-1157	18-1156	18-1113	18-1112	18-1158
1250	2314956 - 2839368	18-1153	—	18-1157	18-1156	—	N/D	18-1158
1350	2839369 - 2940020	18-1153	—	18-1157	18-1156	—	N/D	18-1158
1350	2940021 - 3293233	18-1153	—	18-1157	18-1156	—	N/D	18-1158
1400	3293234 - 3502805	18-1153	—	18-1157	18-1156	—	N/D	18-1158
140	4865687 & Sup	—	—	18-1157	18-1156	N/D	N/D	18-1158
1500	3502806 - 4121434	18-1153	—	18-1157	18-1156	—	N/D	18-1158
1500	4121435 - 4865677	—	—	18-1157	18-1156	—	N/D	18-1158
V-135	A904646 & Sup	18-1143	18-1117	18-1122 ⑤	18-1166	18-1155	N/D	18-1158
V-135	C100861 & Sup	18-1143	18-1117	18-1122 ⑤ ①	18-1166 ① ⑦	18-1155 ①	N/D	18-1158
V-135	C239553 & Sup	18-1143	18-1117	18-1122 ⑥ ①	18-1166 ① ⑦	18-1155 ①	N/D	18-1158
V-135	D082000 & Sup	18-1143	18-1117	18-1115 ①	18-1166 ① ⑦	18-1155 ①	N/D	18-1158
V-150	4868998 - 5432021	18-1164	—	18-1122 ⑤	18-1166	18-1155	N/D	18-1158
V-150	5432022 - 6042945	18-1164	—	18-1122 ⑤	18-1166	18-1155	N/D	18-1158
V-150	6042946 - 6443212	18-1164	—	18-1122 ⑤	18-1166	18-1155	N/D	18-1158
V-150	6443213 - 6616990	18-1164	—	18-1122 ⑤	18-1166	18-1155	N/D	18-1158
V-150	6616991 - A904645	18-1164	—	18-1122 ⑤	18-1166	18-1155	N/D	18-1158
V-150	A904646 & Sup	18-1143	18-1117	18-1122 ⑤	18-1166	18-1155	N/D	18-1158
V-150	C100861 & Sup	18-1143	18-1117	18-1122 ⑤ ①	18-1166 ①	18-1155	N/D	18-1158
V-150	C239553 & Sup	18-1143	18-1117	18-1122 ⑤ ①	18-1166 ① ⑦	18-1155 ①	N/D	18-1158
V-150	D082000 & Sup	18-1143	18-1117	18-1115 ①	18-1166 ① ⑦	18-1155 ①	N/D	18-1158
V-150XRI (EFI)	D082000 & Sup	18-1143	—	18-1157	18-1156 ①	N/D	N/D	18-1158
V-150XRI (EFI)	D082000 & Sup	18-1143	18-1117	18-1115 ⑤ ①	18-1166 ① ⑦	18-1155 ①	N/D	18-1158
V-150XRI (EFI)	D082000 & Sup	18-1143	18-1117	18-1115 ⑤ ①	18-1166 ① ⑦	18-1155 ①	N/D	18-1158
V-175	4301235 - 5393736	18-1164	—	18-1122 ⑤	18-1166	18-1155	N/D	18-1158
V-175	5393737 - 6618750	18-1164	—	18-1122 ⑤	18-1166	18-1155	N/D	18-1158
V-175	6618751 & Sup	18-1143	18-1117	18-1122 ⑤	18-1166	18-1155	N/D	18-1158
V-175	C100861 & Sup	18-1143	18-1117	18-1122 ⑤ ①	18-1166 ① ⑦	18-1155 ①	N/D	18-1158
V-175	C239553 & Sup	18-1143	18-1117	18-1122 ⑥ ①	18-1166 ① ⑦	18-1155 ①	N/D	18-1158
V-175	D082000 & Sup	18-1143	18-1117	18-1115 ①	18-1166 ① ⑦	18-1155 ①	N/D	18-1158
V-175XRI (EFI)	D000750 & Sup	18-1143	18-1117	18-1122 ⑤ ⑥	18-1166	18-1155	N/D	18-1158
V-175XRI (EFI)	D000750 & Sup	18-1143	18-1117	18-1122 ⑤ ⑥	18-1166	18-1155	N/D	18-1158
V-175XRI (EFI)	D082000 & Sup	18-1143	—	18-1157	18-1156 ①	N/D	N/D	18-1158
V-175XRI (EFI)	D082000 & Sup	18-1143	18-1117	18-1115 ⑤ ①	18-1166 ① ⑦	18-1155 ①	N/D	18-1158
V-175XRI (EFI)	D082000 & Sup	18-1143	18-1117	18-1115 ⑤ ①	18-1166 ① ⑦	18-1155 ①	N/D	18-1158
V-200	4839034 - 5363917	18-1164	—	18-1122 ⑤	18-1166	18-1155	N/D	18-1158
V-200	5363918 - 6073191	18-1164	—	18-1122 ⑤	18-1166	18-1155	N/D	18-1158
V-200	6073192 - 6203990	18-1164	—	18-1122 ⑤	18-1166	18-1155	N/D	18-1158
V-200	6203991 - 6435502	18-1164	—	18-1122 ⑤	18-1166	18-1155	N/D	18-1158
V-200	6435503 - 6625220	18-1164	—	18-1122 ⑤	18-1166	18-1155	N/D	18-1158
V-200	6625221 - C100860	18-1143	18-1117	18-1122 ⑤	18-1166	18-1155	N/D	18-1158
V-200 (EFI)	C100861 - C291519	18-1143	18-1117	18-1122 ⑤	18-1166	18-1155	N/D	18-1158
V-200 (2.5L)	C291520 - D081999	18-1143	18-1117	18-1122 ⑥ ①	18-1166 ① ⑦	18-1155 ①	N/D	18-1158
V-200	D082000 & Sup	18-1143	18-1117	18-1115 ①	18-1166 ① ⑦	18-1155 ①	N/D	18-1158
V-200XRI (EFI)	C291520 & Sup	18-1143	18-1117	18-1122 ⑤	18-1166	18-1155	N/D	18-1158
V-200XRI (EFI)	D082000 & Sup	18-1143	—	18-1157	18-1156 ①	N/D	N/D	18-1158
V-200XRI (EFI)	D082000 & Sup	18-1143	18-1117	18-1115 ⑤ ①	18-1166 ① ⑦	18-1155 ①	N/D	18-1158
V-200XRI (EFI)	D082000 & Sup	18-1143	18-1117	18-1115 ⑤ ①	18-1166 ① ⑦	18-1155 ①	N/D	18-1158
V-220	B117316 & Sup	18-1143	18-1117	18-1122 ⑤	18-1166	18-1155	N/D	18-1158
V-225	5628028 & Sup	18-1164	—	18-1122 ⑤	18-1166	18-1155	N/D	18-1158
225	D280813 & Sup	18-1143	18-1117	18-1157 ①	18-1159 ①	18-1155 ①	N/D	18-1158
XR-4 ③	B242885 & Sup	18-1143	—	18-1157	18-1156	N/D	N/D	18-1158
XR-4	B242885 & Sup	18-1143	—	18-1157	18-1156	N/D	N/D	18-1158
XR-4 ③	C100861 & Sup	18-1143	—	18-1157	18-1156	N/D	N/D	18-1158
XR-4 ④	C100861 & Sup	18-1143	—	18-1157	18-1156	N/D	N/D	18-1158
XR-4	C239553 & Sup	18-1143	—	18-1157	18-1156	N/D	N/D	18-1158
XR-6	D082000 & Sup	18-1143	—	18-1157	18-1156	N/D	N/D	18-1158

① Sólo rotación standar.

③ Para unidades con número 1655-9572C.

④ Para unidades con número 1674-814247C.

⑤ Necesita dos cojinetes.

⑥ Para 5/8 cojinete doble.

⑦ Use 18-1155 para aplicaciones contra-rotación.

⑧ Usar piñón 43-19672.

**18-2244****18-22441-9①**

(Env. de 50 Sin junta)

TAPÓN DRENAJE

• 3/8" -16 hilo

Reemplaza: 10-20259, 10-28634, 10-28634A1, 10-79953A2, 10-79953Q2, 10-79953, 10-79953Q04, 816610A1, 816610A2, F40109, 10-F50109
Incluye juntas 18-2945

② **18-2375D****18-2375****18-23751-9①**

(Env. de 50 sin junta)

TAPÓN DRENAJE

• 3/8" -16 hilo

Reemplaza: 10-14834, 10-14834A1, 22-67892, 22-67892A1, 22-67892A05, 22-67892A06, 28-8M0058389
Incluye junta 18-2945

**18-2155****CASQUILLO CAMBIO**

Reemplaza: 23-37428A1, 23-55419A1, 23-77631A2
35-200 HP



18-3719
TUERCA PIÑON
 Reemplaza: 11-35921, 11-47411,
 11-826375, 11-F694188
 hilo 5/8" - 18 • Llave 1 1/16"



18-2359
JUEGO TUERCAS
EJE TRANSMISIÓN
 — INCLUYE —

Sierra #	Descripción	Reemplaza:
18-3719	Tuerca piñon	11-35921
18-2343	Tuerca piñon arand.	12-92721
18-2343-9	Tuerca piñon arandela	12-92721

Ⓢ Precio por envase



18-1736
EJE
 Reemplaza: 45-43031A1
 Para: 100 4 cil (1988 & Sup), 115 4 cil (1989 & Sup),
 125 4 cil (1994 & Sup)



18-1737
EJE (32 1/4" largo)
 Reemplaza: 45-440001
 Para: V-115 DFI 2.5L (2000), V-135 (1986 & Sup), V-135 DFI 2.5L (1998 & Sup), V-150 (1978 & Sup), V-150 EFI (1996-01), V-150 Mag/EFI (1993-95), V-150 DFI 2.5L (1998 & Sup), V-150 Mag (1980-85), V-175 (1976-99), V-175 EFI (1996 & Sup), V-175 Mag/EFI (1991-95), V-175 DFI 2.5L (2001 & Sup), V-175 XRI EFI (1991-95), V-200 (1978 & Sup), V-200 EFI (1989-01), V-200 Mag/EFI (1992-95), V-200 EFI 2.5L (2002 & Sup), V-200 XRI/EFI (1991-95), XR-4 (1988-91), XR-6 (1992 & Sup)



18-2254
EJE TRANSMISIÓN
 Reemplaza: 44-850308



18-2239
EJE TRANSMISIÓN
 Reemplaza: 44-94148



18-2260
EJE TRANSMISIÓN
 Reemplaza: 44-17915, 44-98418



18-2236
SELECTOR CAMBIO
 Reemplaza: 52-12777, 52-34239, 52-814756,
 52-822539, 52-822539T



18-1550
KIT COMPLETO ENGRANAJES
 Reemplaza: 43-850036T,
 43-881260A3, 52-850048T
 Avante, Piñon, Reverso y selector para 4 cil.: Para: 100 4 cil con 6 dientes desplazable reverso(1988-98), 115 4 cil con 6 dientes desplazable reverso (1989-98), 125 4 cil con 6 dientes desplazable reverso(1994-98) (2.07:1 Ratio)



18-1551
KIT COMPLETO DE ENGRANAJES
 Reemplaza: 43-803615T2,
 52-859340T, 43-828175A1
 Avante, Piñon, Reverso y selector de V-6:
 Para: V-150 (XR6, Mag III)(1997 & Sup), V-150 EFI (1997 & Sup), V150 DFI (1998 & Sup), V-175 (1997 & Sup), V-175 EFI (1997 & Sup), V-175 DFI (2001 & Sup), V-200 (1997 & Sup), V-200EFI 2.5L (1997 & Sup) (1.87:1 Ratio)



18-1560
REVERSO ENGRANAJE
 Reemplaza: 43-850036T, 43-850036
 Para: 75 4-tiempos (2000-02), 90 4-tiempos (2000-02), 100 4 cil con 6 JAW Rev despl. (1988 & Sup), 115 4 cil con 6 dientes Rev despl. (1989 & Sup), 115 4-tiempos EFI (2001 & Sup), 125 4 cil con 6 dientes Rev despl. (1994 & Sup) (2.07:1 Ratio)



18-1562
SELECTOR
 Reemplaza: 52-850048T, 53-850048
 Para: 40 4-tiempos 4 cil Bigfoot(2001 & Sup), 50 4-tiempos Bigfoot (1995 & Sup), 60 3 cil con 6 dientes Rev (1998 & Sup), 60 4-tiempos Bigfoot (2001 & Sup), 70 3 cil con 6 dientes Rev despl. (1987 & Sup), 75 3 cil con 6 dientes despl. (1990-98), 75 3 cil (1999 & Sup), 75 4-tiempos 1596cc (2000-03), 80 3 cil con 6 dientes Rev despl. (1987 & Sup), 90 3 cil con 6 dientes Rev despl (1987-98), 90 3 cil (1999 & Sup), 90 4-tiempos 1596cc (2000-03), 100 4 cil w 6 dientes Rev despl. (1988-98), 100 4 cil (1999 & Sup), 115 4 cil con 6 dientes Rev despl. (1989-98), 115 4 cil (1999 & Sup), 115 4-tiempos 1741cc (2001-03), 125 4 cil con 6 dientes Rev despl. (1994-98), 125 4 cil (1999 & Sup)



18-1564
KIT ENGRANAJE
 Reemplaza: 43-803615T2, 43-803615T1
 Para: V-150 (1978 & Sup), V-150 EFI (1996-01), V-150 DFI 2.5L (1998 & Sup), V-150 EFI 2.5L (2002 & Sup), V-175 EFI (1996-01), V-175 DFI 2.5L (2001 & Sup), V-175 EFI 2.5L (2002-03), V-200 (1978 & Sup), V-200 EFI (1989-01), V-200 EFI 2.5L (2002 & Sup) (1.87:1 Ratio)



**18-1565
SELECTOR**

Reemplaza: 52-859340T
Para: V-115 DFI 2.5L (2000), V-135 (1986 & Sup), V-135 DFI 2.5L (1998 & Sup), V-150 (1978 & Sup), V-150 EFI (1996-01), V-150 Mag/EFI (1993-95), V-150 DFI 2.5L (1998 & Sup), V-150 Mag (1980-85), V-175 (1976-99), V-175 EFI (1996 & Sup), V-175 Mag/EFI (1991-95), V-175



**18-1566
ENGRANAJE REVERSO**

Reemplaza: 43-828175A1
Para: V-150 (1978 & Sup), V-150 EFI (1996-01), V-150 DFI 2.5L (1998 & Sup), V-175 (1976-99), V-175 EFI (1996-01), V-175 DFI 2.5L (2001 & Sup), V-200 (1978 & Sup), V-200 EFI (1989-01), V-200 EFI 2.5L (2002 & Sup), XR-6 (1992-99) (1.87:1 Ratio)

**18-4830
CARCASA COLA**

Reemplaza: 1667-9011G59

Para: 100 4cil (1988-99), 115 4cil (1989 & Sup), 115 3cil DFI (2004 & Sup), 115 EFI 4-Tiempos(2001 & Sup), 125 4cil (1994 & Sup), 30 4-tiempos (1999-01), 30 Carb 3cil 4-tiempos (2002 & Sup), 40 4-tiempos (1998-01), 40 4-tiempos 4cil (2001-02), 40 Carb 3cil 4-tiempo (2002 & Sup), 40 EFI 4cil 4-tiempos (2002 & Sup), 40 Jet (2001 & Sup), 45 Jet (1994-98), 50 4-tiempos (1995-00), 50 4cil 4-tiempos (2001-02), 50 Bigfoot 4-tiempos(1995-00), 50 EFI 4cil 4-tiempos (2002 & Sup), 55 3cil (1996 & Sup), 60 3cil (1984 & Sup), 60 3cil Bigfoot (1998), 60 4cil 4-tiempos (2001-02), 60 EFI 4cil 4-tiempos (2002 & Sup), 65 Jet (1994 & Sup), 75 3cil (1987 & Sup), 75 4-tiempos (2000 & Sup), 75 3cil 1.5L DFI (1995 & Sup), 80 Jet (1994 & Sup), 90 3cil (1987 & Sup), 90 4-tiempos (2000 & Sup), 90 3cil 1.5L DFI (2004 & Sup) con 6 dientes (Design II)



**18-4850
COLA COMPLETA**

Reemplaza: 1667-9011G77, 1667-9011G78, 1667-9011G10, 1667-9011G11, 1667-9011G51, 1667-9011J6, 1667-9011R6

Para: 100/115/125 4-cil con 6 dientes (Design II) (2.07:1 Ratio)



**18-4851
COLA COMPLETA**

Reemplaza: 1647-6693A3, 1647-7350A5, 1647-7350A26, 1647-8688A1, 1647-9148A69, 1647-9148A8, 1647-9148A84, 1647-9148T84, 1647-9148R84
Para: 135/150/200/225 V6 (1.87:1 Ratio)



APLICACIONES FUERABORDA MERCURY UNIDAD INFERIOR

Modelo	Número de serie	Eje transmisión	Tuerca piñon	Eje hélice	Selector
40 4 tiempos - BigFoot	0T178500 - 1B226999		18-3719	18-2254	18-1562
50 4 tiempos - BigFoot	0G231123 - 1B226999		18-3719	18-2254	18-1562
60 Sea Pro/Marathon/BigFoot	0G590000 & Sup		18-3719	18-2254	18-1562 ④
60 Four Stroke - BigFoot	0T178500 - 1B226999		18-3719	18-2254	18-1562
650 (4 cil.)	1542745 - 1765403	N.L.A.	—	—	18-2236
650 (4 cil.)	2119749 - 2309310	—	—	—	18-2236
650 (4 cil.)	2309311 - 2452709	—	18-3719	—	18-2236
650 (4 cil.)	2503991 - 2803561	—	18-3719	—	18-2236
650 (4 cil.)	2803562 - 2874263	—	18-3719	—	18-2236
650 (4 cil.)	2997339 & Sup	—	18-3719	—	18-2236
70 (3 cil.)	A996142 - & Sup	—	18-3719	—	18-2236 ⑤
70 (3 cil.)	A996142 - & Sup	—	18-3719	18-2254	18-1562
75 (4 cil.)	6432901 & Sup	—	18-3719	—	18-2236
75 (3 cil.)	A996142 - & Sup	—	18-3719	—	18-2236 ⑤
75 (3 cil.)	A996142 - 0G760299	—	18-3719	18-2254	18-1562
75 (3 cil.)	0G760300 & Sup	—	18-3719	18-2254	18-1562
75 DFI	0T980000 & Sup	—	18-3719	18-2254	18-1562
75 4 tiempos	0G960500 - 0T800999	—	18-3719	18-2254	18-1562
800 (4 cil.)	2559001 - 3144218	—	18-3719	—	18-2236
800 (4 cil.)	3144219 - 3493912	—	18-3719	—	18-2236
80 (4 cil.)	4831999 - 6432900	—	18-3719	—	18-2236
80 (3 cil.)	A996142 & Sup	—	18-3719	—	18-2236 ⑤
80 (3 cil.)	A996142 & Sup	—	18-3719	18-2254	18-1562 ④
850 (4 cil.)	3493913 - 4831998	—	18-3719	—	18-2236
900 (6 cil.)	1766824 - 1869775	N.L.A.	—	—	18-2236
900/90 (6 cil.)	4845301 - & Sup	—	18-3719	—	18-2236
90 (3 cil.)	A996142 - 0G760299	—	18-3719	—	18-2236 ⑤
90 (3 cil.)	A996142 - 0G760299	—	18-3719	18-2254	18-1562 ④
90 (3 cil.)	0G760300 & Sup	—	18-3719	18-2254	18-1562
90 DFI	0T801000 & Sup	—	18-3719	18-2254	18-1562
90 4 tiempos	0G960500 - 0T800999	—	18-3719	18-2254	18-1562

① Solo eje largo ③ Solo offshore ⑤ 3 d. Selector rev transm.
 ② Solo rotación standard ④ 6d. selector reverso ⑥ Pasador, sin tuerca eje N.D No disponible

APLICACIONES CONTINUAN EN LA PRÓXIMA PÁGINA

APLICACIONES FUERABORDA MERCURY UNIDAD INFERIOR

Modelo	Número de serie	Eje transmisión	Tuerca piñon	Eje hélice	Acople
100 (4 cil.)	B209468 - 0G760299	—	18-3719	—	18-2236 ⑤
100 (4 cil.)	B209468 - 0G760299	—	18-3719	18-2254	18-1562 ④
100 (4 cil.)	0G760300 & Sup	—	18-3719	18-2254	18-1562
1150	2836019 - 2933900	—	18-3719	—	18-2236
1150	2933901 - 3525440	—	18-3719	—	18-2236
1150	3525441 - 4112634	—	18-3719	—	18-2236
1150	4112635 - 4855152	—	18-3719	—	18-2236
1150 / 115	4855153 - 5314655	—	18-3719	—	18-2236
115 (6 cil.)	5314656 - 5600966	—	18-3719	—	18-2236
115 (6 cil.)	5600967 - 6436122	—	18-3719	—	18-2236
115 (6 cil.)	6436123 & Sup	—	18-3719	—	18-2236
115 (4 cil.)	C100000 - 0G760299	—	18-3719	—	18-2236 ⑤
115 (4 cil.)	C100000 - 0G760299	—	18-3719	18-2254	18-1562 ④
115 (4 cil.)	0G760300 & Sup	—	18-3719	18-2254	18-1562
115 DFI	0T801000 & Sup	—	18-3719	18-2254	18-1562
115 4 tiempos	0T178500 - 0T800999	—	18-3719	18-2254	18-1562
1250	2314956 - 2839368	—	18-3719	—	18-2236
125 (4 cil.)	0D283222 - 0G760299	—	18-3719	—	18-2236 ⑤
125 (4 cil.)	0D283222 - 0G760299	—	18-3719	18-2254	18-1562 ④
125 (4 cil.)	0G760300 & Sup	—	18-3719	18-2254	18-1562
1350	2839369 - 2940020	—	18-3719	—	18-2236
1350	2940021 - 3293233	—	18-3719	—	18-2236
1400	3293234 - 3502805	—	18-3719	—	18-2236
140	4865687 & Sup	—	18-3719	—	18-2236
1500	3502806 - 4121434	—	18-3719	—	18-2236
1500	4121435 - 4865677	—	18-3719	—	18-2236
V-135	0A904646 - 0G437999	18-1737	18-3719	18-2239	—
V-135	0G438000 - 0T178499	18-1737	18-3719	18-2239 ②	—
V135 DFI	G590000 - 1B417701	18-1737	18-3719	18-2239	18-1565
V140	T178500 & Sup	—	18-3719	18-2239	—
V-150 (Casting # 1647-6670C)	4868998 - 0A904645	—	18-3719	—	—
V-150 (Casting #1647-8675C)	4868998 - 0A904645	—	18-3719	18-2239	—
V-150	4868998 - 0A904645	18-1737	18-3719	18-2239	—
V-150	0A904646 - 0G437999	18-1737	18-3719	18-2239	—
V-150	0G438000 & Sup	18-1737	18-3719	18-2239	18-1565
V-150 XR-4 (Casting #1655-9572C)	B242885 - 0D081999	—	18-3719	—	18-2236
V-150 XR-4 (Casting #1674-814247C)	B242885 - 0D081999	—	18-3719	—	18-2236
V-150 XR-6	D082000 - 0G303045	18-1737	18-3719	18-2239	18-2236
V-150 XR-6	0G438000 & Sup	18-1737	18-3719	18-2239	18-1565
V-150XRI (EFI)	D082000-0G437999	18-1737	18-3719	— ②	18-2236 ②
V-150XRI (EFI)	0G438000 & Sup	18-1737	18-3719	18-2239 ②	18-1565
V150 DFI	G590000 & Sup	18-1737	18-3719	18-2239	—
V-175	4301235 - 5393736	— ⑥	18-3719	—	—
V-175	5393737 - 6618750	— ⑥	18-3719	18-2239	—
V-175	6618751 - 0G437999	18-1737	18-3719	18-2239	—
V-175	0G438000 & Sup	18-1737	18-3719	18-2239	18-1565
V-175XRI (EFI)	D000750 - 0G437999	18-1737	18-3719	18-2239	—
V-175XRI (EFI)	0G438000 & Sup	18-1737	18-3719	18-2239	18-1565
V-200	4839034 - 6625220	— ⑥	18-3719	18-2239	—
V-200	6625221 - 0G437999	18-1737	18-3719	18-2239	—
V-200	0G438000 & Sup	18-1737	18-3719	18-2239	18-1565
V-200 (EFI)	C100861 - 0G437999	18-1737	18-3719	18-2239	—
V-200 (EFI)	0G438000 & Sup	18-1737	18-3719	18-2239	18-1565
V-200 (2.5L)	C291520 - D081999	—	18-3719	18-2239 ②	—
V-200 DFI	0G438000 & Sup	—	18-3719	—	18-1565
V-220	B117316 & Sup	—	18-3719	18-2239	—
V-225	5628028 & Sup	— ①	18-3719	18-2239	—
225	D280813 & Sup	—	18-3719	—	—
MODELOS ALTAS PRESTACIONES					
2.4 EFI	B290010 & Sup	—	18-3719	18-2260 ② ③	—
XR-2	B290314 - C276429	—	18-3719	18-2260 ②	—
MOD-VP	B290066 - C276379	—	18-3719	18-2260	—

- ① Solo eje largo ③ Solo offshore ⑤ Acople 3 d reverso transm.
 ② Solo rotación standard ④ Acople 6d. reverso ⑥ Pasador, sin tuerca eje N.D No disponible

<p>Env. de 10</p>  <p>18-0202-9® MUELLE Reemplaza: 8227731 Para: Mercury/Mariner 25-125hp Fueraborda</p>	 <p>18-3751 TUERCA CIERRE Reemplaza: 79448 Para: V-6</p>	 <p>18-2298 ARANDELA CIERRE Reemplaza: 14-18323, 14-17460</p>																				
 <p>18-2299 ARANDELA CIERRE Reemplaza: 14-79447, 14-52833</p>	 <p>TUERCAS DE ACERO INOX</p>	<table border="1"> <thead> <tr> <th>Ref #</th> <th>O.E. #</th> <th>Medida rosca</th> <th>Cant. env.</th> </tr> </thead> <tbody> <tr> <td>18-3720 ⑦</td> <td>11-34932</td> <td>3/8" - 24</td> <td>1</td> </tr> <tr> <td>18-3721 ⑦</td> <td>11-34933, 11-95702 11-82671015, 11-46355 11-33962, 11-29241, 11-24648, 11-22178, 11-21298</td> <td>7/16" - 20</td> <td>6</td> </tr> <tr> <td>18-3722 ⑦</td> <td>11-35888, 11-20361, 11-8267089</td> <td>1/4" - 28</td> <td>5</td> </tr> <tr> <td>18-3723 ⑦</td> <td>11-45592</td> <td>5/16" - 24</td> <td>1</td> </tr> </tbody> </table>	Ref #	O.E. #	Medida rosca	Cant. env.	18-3720 ⑦	11-34932	3/8" - 24	1	18-3721 ⑦	11-34933, 11-95702 11-82671015, 11-46355 11-33962, 11-29241, 11-24648, 11-22178, 11-21298	7/16" - 20	6	18-3722 ⑦	11-35888, 11-20361, 11-8267089	1/4" - 28	5	18-3723 ⑦	11-45592	5/16" - 24	1
Ref #	O.E. #	Medida rosca	Cant. env.																			
18-3720 ⑦	11-34932	3/8" - 24	1																			
18-3721 ⑦	11-34933, 11-95702 11-82671015, 11-46355 11-33962, 11-29241, 11-24648, 11-22178, 11-21298	7/16" - 20	6																			
18-3722 ⑦	11-35888, 11-20361, 11-8267089	1/4" - 28	5																			
18-3723 ⑦	11-45592	5/16" - 24	1																			

⑦ Precio por pieza. Para pedir envasado añade -9 a la referencia.
 ⑧ Precio por envasado

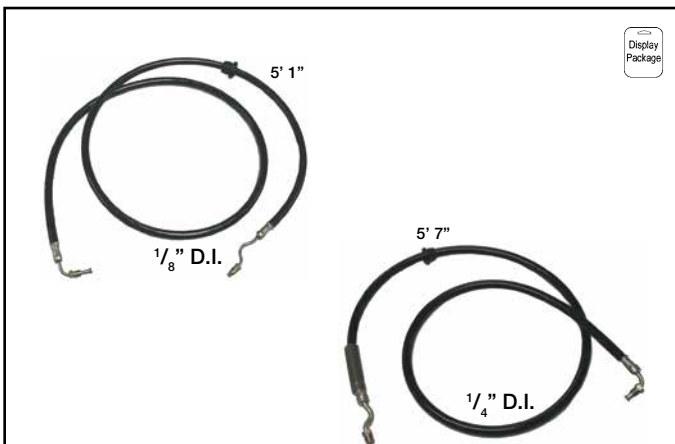

MANGUERA POWER TRIM

Para los equipados con power trim, motores en línea excepto aquellos con bomba power trim montada entre soportes de abrazaderas del motor.

Ref #	Reemplaza:	Descripción
18-2110	32-45327, 32-88005, 32-97153A1	Diámetro pequeño 2 por motor
18-2111	32-88006, 32-45959, 32-97154A1	Diámetro grande 2 por motor



18-3701
KIT TUERCA HÉLICE
Reemplaza: 11-52707A1, 11-52707A2, 11-52707Q1
— CONTIENE —

Ref #	O.E. #	Descripción
18-3200 (2)	14-31210, 14-816629	Aran.bloqueo
18-3700	11-52707	Tuerca hélice



18-3200
18-3200-9②
ARANDELA BLOQUEO
Reemplaza: 14-31210, 14-816629, 14-816629Q, 14-F697140



18-3702
KIT TUERCA HÉLICE
Reemplaza: 11-69578A1, T1, Q1
— CONTIENE —

Ref #	O.E. #	Description
18-3204 (2)	14-76281	Aran.bloqueo
18-3704	11-69578	Tuerca hélice



18-3204
18-3204-9②
ARANDELA BLOQUEO
Reemplaza: 14-76281



18-3700
TUERCA HÉLICE
Reemplaza: 11-52707, 11-52707A1, 11-52707Q1, 11-52707A2, 11-827614 F7040



18-3704
TUERCA HÉLICE
Reemplaza: 11-69578



18-3703
TUERCA HÉLICE
Reemplaza: 11-88228
Para: 9.9-25 HP 1986-Sup



18-3714
ARANDELA DE BRONCE
Reemplaza: 12-31211A2, 12-31211, 12-31211A3, 12-31211Q03
Para: 135-275 HP (V6 2 ciclos)

APLICACIÓN ARANDELA BLOQUEO/TUERCA HÉLICE / KIT TUERCA

HP	Desde	Hasta	Arandela Bloqueo	Tuerca Hélice	Kit tuerca Hélice	HP	Desde	Hasta	Arandela bloqueo	tuerca Hélice	Kit tuerca Hélice
9.9 ④	G760300	& SUP	—	18-3703	—	80	2559001	& SUP	18-3200	18-3700	18-3701
15 ④	G590000	& SUP	—	18-3703	—	85	1460999	3493912	18-3200	—	—
18	5837437	& SUP	—	18-3703	—	85	3493913	4831998	18-3200	18-3700	18-3701
20	6443973	& SUP	—	18-3703	—	90	1766824	4845300	18-3200	—	—
25	6416713	& SUP	—	18-3703	—	90	4845301	& SUP	18-3200	18-3700	18-3701
35	— ③	—	18-3204	18-3704	18-3702	95	1869776	2318585	18-3200	—	—
40	— ③	—	18-3204	18-3704	18-3702	100	1464949	2484632	18-3200	—	—
50	— ③	—	18-3204	18-3704	18-3702	100	2484633	2836018	18-3200	18-3700	18-3701
60	— ③	—	18-3204	18-3704	18-3702	100	B209468	& SUP	18-3200	18-3700	18-3701
65	1542745	2503990	18-3200	—	—	110	1870204	2314955	18-3200	—	—
65	2503991	3293183	18-3200	18-3700	18-3701	115	2836019	& SUP	18-3200	18-3700	18-3701
70	1482212	1566239	18-3200	—	—	125	2314956	2536209	18-3200	—	—
70	— ③	A996141	18-3204	18-3704	18-3702	125	2536210	2839368	18-3200	18-3700	18-3701
70	A996142	& SUP	18-3200	18-3700	18-3701	135	2839369	3293233	18-3200	18-3700	18-3701
75	6432901	& SUP	18-3200	18-3700	18-3701	140	3293234	& SUP	18-3200	18-3700	18-3701
80	1405637	1566239	18-3200	—	—	150(En línea)	3502806	& SUP	18-3200	18-3700	18-3701
③ Para mayoría de aplicaciones ④ 4-Tiempos Bigfoot						V-6	TODOS	—	18-3200	18-3700	18-3701



18-4444
LLAVE HÉLICE
Reemplaza: 91-95830A1, 91-95830, 91-38277A1



18-4446
LLAVE HÉLICE Y KIT TUERCAS
— CONTIENE —

Ref #	Descripción	O.E. #	Cant.
18-3200	Arandela	14-31210, 14-816629	2
18-3700	Tuerca hélice	11-52707	1
18-4444	Llave hélice	91-95830A1	1



18-4459
LLAVE HÉLICE
Reemplaza: 91-821887A1, 91-859046Q4, 91-859046T4

① Referencias acabadas en "D" envasadas
② Precio por Pack



18-9075
ESPACIADOR
Reemplaza: 23-888690
Para: 2-tiempos: 115hp. - 300hp. (1993-Actual)
4-tiempos: 115hp. - 225hp. (2002-Actual)



18-9076
COLLAR
Reemplaza: 23-888690-1
Para: 2-tiempos: 115hp. - 300hp. (1993-actual)
4-tiempos: 115hp. - 225hp. (2002-actual)



18-9077
ARANDELA
Reemplaza: 13-888363-2
Para: 2-tiempos: 115hp. - 300hp. (1993-actual) 4-tiempos: 115hp. - 225hp. (2002-actual)



18-9079
KIT ARANDELAS
Reemplaza:
Para: Yamaha 2-tiempos 115-300hp (1993 & Sup); Yamaha 4-tiempos 115-225hp (2002 & Sup); Mercury 4-tiempos 225 EFI S/N OT653945 & Sup



18-9078
ARANDELA ACERO INOXIDABLE
Reemplaza: 12-855682-2
Para: 2-tiempos: 115hp. - 300hp. (1993-Actual)
4-tiempos: 115hp. - 225hp. (2002-Actual)



18-4220D Display Package
ARANDELA

Ref #	Reemplaza
18-4220	12-13171, 12-77987, 12-8354671, 12-77987A1, 12-835467, 12-835467Q01 V-6 fueraborda y Colas Mercuriser
18-4221	13191A1, 75282A1 4 & 6 En línea - 75-150 HP



18-4233
ARANDELA
Reemplaza: 73345, 73345A1, 12-92647M
35-70 HP



18-73890
ARANDELA HÉLICE
Reemplaza: 803743
Para: Mercury 8/9.9(R042475 & Sup)



Display Package
18-9010
TOMA DE AGUA Reforzada



18-3607
SOPORTE
Reemplaza: 893409
Para: 200/225 4-tiempos Verado (S/N OT980000 & Sup), 250/275 4-tiempos Verado (S/N OT801000 & Sup)



18-2700
KIT RETÉN CILINDRO DIRECCIÓN
Reemplaza: 896173A01, 8M0045604
Para: 200/225 4-tiempos Verado (S/N OT980000 & Sup), 250/275 4-tiempos Verado (S/N OT801000 & Sup)



18-79989
ARRASTRE STICKS
Para: Para mayoría de fuerabordas hasta 150 hp con tilt/trim integral.

Zinc es para aplicaciones en agua salada.
Magnesio es para aplicaciones en agua dulce.
Aluminio es para aplicaciones en agua dulce y salada.

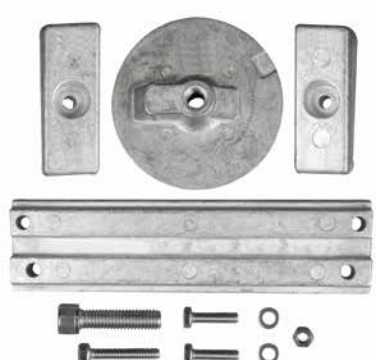

18-6156A
18-6156M
KIT ANODOS
Verados 4 cil. Todos los modelos



18-6157A
18-6157M
KIT ANODOS
Reemplaza: 8M0058677
Verado 6 cil. Todos los modelos



② **18-6241**
③ **009354**
① **18-6011A**
ANODOS
Reemplaza:
31640, 31640A1, 97-31640Q4, 97-31640B4, 31640A4, 31640A2, 316404, 316403, 72436A1
Use en línea 3, 4 & 6 Cil, V6



③ **025849**
① **18-6014A**
ANODOS
Reemplaza:
46399A1, 822777A1, 822777Q1, 822777A4, 822777A3, 8227772, 822777, 463999A2
Para uso con 225 (3.0L Carb.) modelos



③ **009371**
③④ **18-60161**
③⑤ **18-60161-9**
① **18-6016A**
② **18-6244**
ANODOS
Reemplaza:
76214, 97-76214Q5, 97-762145, 76214A5, 786214A2, 762142, 762142A1
200, 225, 250HP, V-155-V-200, & Todos Bravos



③ **009464**
ANODOS
Reemplaza: 826134, 826134A1, 97-826134Q

① Aluminio ② Magnesio ③ Zinc
④ Envase de 10 unidades ⑤ Envase de 10 unidades



③ 025848
① 18-6249A
ANODO PLACA MONTAJE
Reemplaza: 43396A2, 818298A1, Q1
Para uso en soporte de transm: 175HP/150EFI/200EFI (S/N OG303046 & Sup)

① 18-6245D Display Package



18-6245
TORNILLO MONTAJE ÁNODO
Reemplaza: 10-32470
Para uso con: 18-6011, 18-6014, 18-6016
7/16" X 1 3/4" Allen H



18-2599
RETEN/HERRAMIENTA
Reemplaza: 26-816575A2



18-2742
MANGUITO FUELLE
Reemplaza: 85552

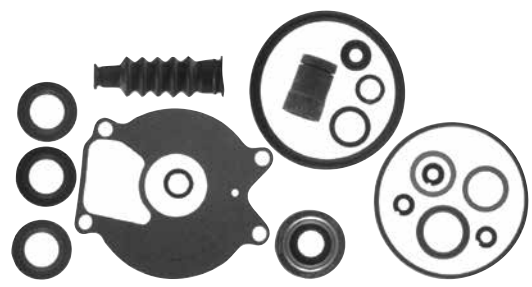

18-2624
KIT RETENES PARTE INFERIOR
Reemplaza: 26-85090A2

— CONTIENE —

Ref #	Descripción	O.E.#	Cant.
18-0579	Retén	26-41131	1
18-0580	Retén	26-41132	1
18-0586	Retén	26-99325	2
18-7419	Aro	25-69202	1
18-2562	Junta	27-99326-1	1
18-2945	Arandela	12-20260	2
18-2742	Manguito fuelle	85552	1
18-2560	Arandela	12-86645	2
18-7135	Aro	25-35276	1
18-7188	Aro	25-805726	2
18-7956	Aro	25-85549	1
18-7100	Aro	25-85594	1

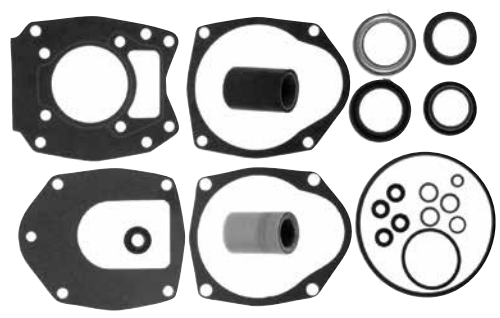

18-2626
KIT RETENES PARTE INFERIOR
Reemplaza: 26-43035A4, 26-43034A1, 26-43034A2, 26-43034A3

— CONTIENE —

Ref #	Descripción	O.E.#	Cant.
18-0522	Retén	26-43036	1
18-0583	Retén	26-43035	1
18-2002	Retén	26-30550, 26-76868	1
18-2053	Retén	26-70081	1
18-2054	Retén	26-8164641	1
18-2563	Junta platina a tapa Bomba de agua	27-43034-1	1
18-2564	Junta base bomba agua a platina	27-43033-1	1
18-2565	Junta aloj. engranaje a base bomba de agua	27-43047-2	1
18-2566	Junta platina a tapa bomba de agua	27-817277	1
18-2945	Arandela	12-19183	3
18-4261	Arandela	19643	1
18-7188	Aro	25-805726	1
18-7198	Aro	25-45710	1

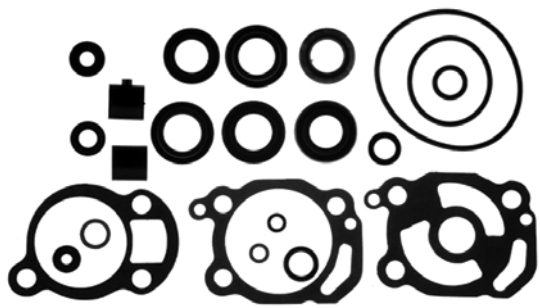

18-2627
KIT RETENES PARTE INFERIOR
Reemplaza: 26-66303A1

— CONTIENE —

Ref #	Descripción	O.E.#	Cant.
18-0595	Retén	26-66303	2
18-2004	Retén, Base bomba de agua	26-20070	2
18-2006	Retén, Base bomba de agua	26-897154	1
18-2019	Retén	26-26805	1
18-2827	Junta platina superior a bomba de agua	27-39623	1
18-2828	Junta base bomba inferior	27-39625	1
18-2945	Arandela	12-20260	1
18-4261	Arandela	12-20262	1
18-7120	Aro	25-38933	1
18-7163	Aro	25-33465	1
18-7164	Aro	25-33466	1
18-7180	Aro	25-26802	2

① Aluminio

③ Zinc

— CONTIENE —

Ref #	Descripción	O.E.#	Cant.
18-0584	Retén aceite, eje hélice	26-66022	1
18-2010	Retén, base bomba de agua	26-897153	1
18-2945	Arandela	12-20260	1
18-4261	Arandela	12-20262	1
18-7116	Aro	25-62704	1
18-7120	Aro	25-38933	1
18-7156	Aro	25-29439	1
18-7168	Aro	25-48171	1
18-7171	Aro	25-30529	1
18-7180	Aro	25-26802	1
18-8308	Retén, eje cambio	26-30696	1
18-8310	Retén, base bomba de agua	26-30900T	1

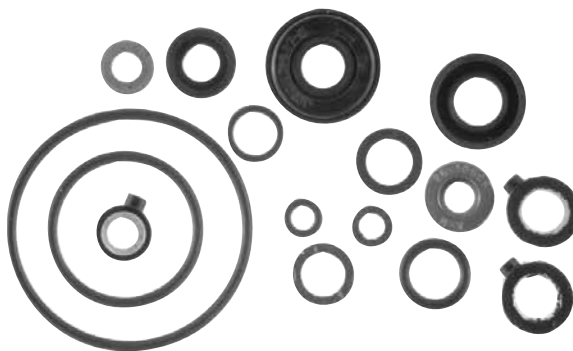

18-2628
KIT RETENES PARTE INFERIOR
 Reemplaza: 26-77066A1

— CONTIENE —

Ref #	Descripción	O.E.#	Cant.
18-2006	Retén	26-897154	2
18-2560	Arandela	12-86645	2
18-2562	Junta alojamiento engr. a platina	27-99326-1	1
18-2742	Junta	85552	1
18-2945	Arandela	12-20260	2
18-7135	Aro	25-35276	1
18-7419	Aro	25-69202	1
18-7956	Aro	25-85549	1
18-7100	Aro	25-85594	1
18-8348	Aro	25-86203	1



18-2629
KITS RETENES PARTE INFERIOR
 Reemplaza: 26-85090A1

— CONTIENE —

Ref #	Descripción	O.E.#	Cant.
18-0500	Retén	26-817472	1
18-0622	Junta, platina inferior	27-19701	1
18-2051	Retén	26-69188	1
18-2052	Retén	26-69189	1
18-2945	Arandela	12-19183	3
18-7168	Aro	25-48171	2
18-7173	Aro	25-30224	1
18-7950	Aro	25-45258	1



18-2635
KIT RETENES PARTE INFERIOR
 Reemplaza: 26-814669A2

— CONTIENE —

Ref #	Descripción	O.E.#	Cant.
18-2563	Junta platina a bomba de agua	27-43034-1	1
18-2564	Junta base bomba de agua a platina	22-43033-1	1
18-2945	Junta tornillo a drenaje	12-19183,12-20260	2
18-2599	Retén y herramienta	26-816575A2	1
18-2014	Retén	26-89238	1
18-2013	Retén	26-16977	1
18-2054	Retén	26-8164641	1
18-7159	Retén	25-31534	1
18-7176	Retén	25-90011	1
18-7420	Retén	25-21836	2
18-7440-1	Retén	25-36318	2

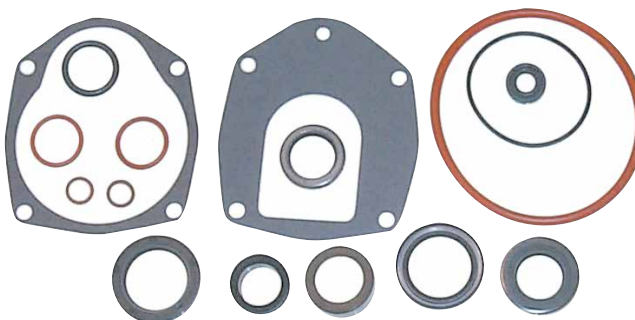

18-2642
KIT RETENES PARTE INFERIOR
 Reemplaza: 26-816575A5



18-2646-1
KIT RETENES CAJA DE ENGRANAJES
 Reemplaza: 26-816575A3, 26-816575A1

-- CONTIENE --			
Ref #	Descripción	O.E.#	Cant.
18-2599	Retén y herramienta	26-818575A2	1
18-2564	Junta base bomba de agua a platina	27-43033-1	1
18-2566	Junta platina a tapa bomba de agua	27-817277	1
18-2945	Arandela	12-19183	1
18-2944	Retén	26-45577	1
18-2002	Retén	26-30550, 26-76868	1
18-2009	Retén	26-892361	1
18-2013	Retén	26-16977	1
18-2014	Retén	26-89238	1
18-2056	Retén	26-965031	2
18-2076	Retén	26-12224	1
18-2077	Retén	26-14077	1
18-7159	Aro	25-31534	1
18-7168	Aro	25-48171	2
18-7176	Aro	25-90011	1
18-7420	Aro	25-21836	2
18-7440-1	Aro	25-36318	2
18-2056	Aro	26-66302	2
18-7413	Aro	25-62702	2
18-2009	Retén	26-892361	1
18-2430	Junta tornillo drenaje	26-830749	1



18-2653
KIT RETENES CAJA ENGRANAJES
 Reemplaza: 26-55682A1

-- CONTIENE --			
Ref #	Descripción	O.E.#	Cant.
18-3110	Retén	26-38970	1
18-2002	Retén	26-30550, 26-76868	2
18-2007	Retén	26-94038	1
18-2009	Retén	26-892361	1
18-2013	Retén	26-16977	1
18-2014	Retén	26-89238	1
18-2048	Retén	26-24590	1
18-2050	Retén	26-55682	1
18-2053	Retén	26-70081	1
18-2826	Junta base bomba agua a alojamiento engranaje	27-85610-1	1
18-2914	Junta bomba agua	27-85608-1	1
18-2915	Junta bomba de agua	27-85609-1	1
18-2948	Arandela	12-49221-1	1
18-7153	Aro	25-25439	1
18-7157	Aro	25-29976	1
18-7158	Aro	25-30613	1
18-7159	Aro	25-31534	1
18-7161	Aro	25-32546	1
18-7162	Aro	25-33145	1
18-7173	Aro	25-30224	1
18-2801	Junta bomba de agua	27-32438	1
18-7426	Aro	25-30271	1
18-2945	Junta tornillo drenaje	12-20260, 12-19183	2

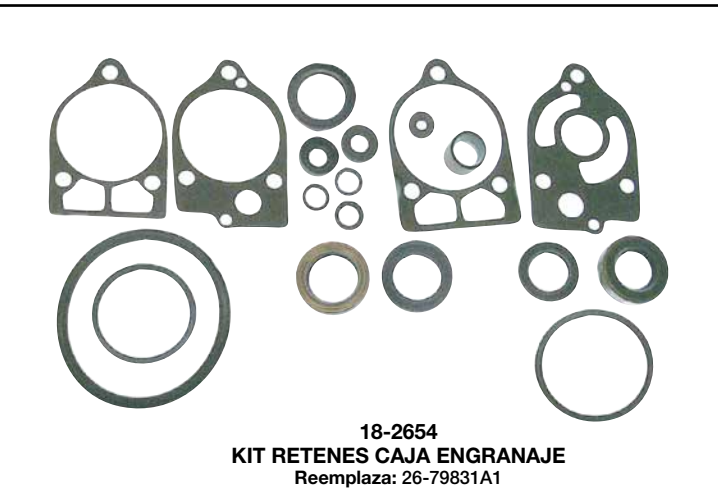

18-2654
KIT RETENES CAJA ENGRANAJE
 Reemplaza: 26-79831A1

-- CONTIENE --			
Ref #	Descripción	O.E.#	Cant.
18-2008	Retén	26-56788	1
18-2011	Retén	26-90562	1
18-2048	Retén	26-24590	1
18-2051	Retén	26-69188	1
18-2052	Retén	26-69189	1
18-2054	Retén	26-816464	1
18-2055	Retén	26-79831	1
18-2823	Junta base bomba agua inferior	27-32769	1
18-2824	Junta platina superior a cuerpo de bomba	27-19551	1
18-2825	Junta base bomba de agua	27-32770	1
18-2841	Junta base bomba de agua	27-19552, 27-77417	1
18-2948	Arandela de goma	12-49221-1	1
18-7153	Aro	25-25439	1
18-7155	Aro	25-26855	1
18-7160	Aro	25-31986	1
18-7115	Aro	25-26722	1
18-2945	Junta tornillo drenaje	12-20260, 12-19183	2

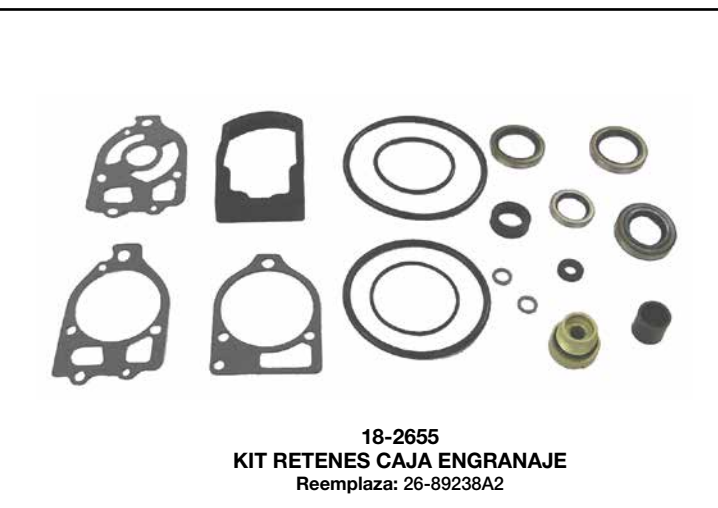

18-2655
KIT RETENES CAJA ENGRANAJE
 Reemplaza: 26-89238A2

-- CONTIENE --			
Ref #	Descripción	O.E.#	Cant.
18-2155	Junta	23-77631A2	1
18-2919	Junta	27-42631-1	1
18-2002	Retén	26-30550, 26-76868	2
18-2013	Retén	26-16977	1
18-2014	Retén	26-89238	1
18-2914	Junta bomba de agua	27-85608-1	1
18-2915	Junta bomba de agua	27-85609-1	1
18-3110	Aro	26-38970	1
18-7159	Aro	25-31534	1
18-7176	Aro	25-90011	1
18-7157	Aro	25-29976	1
18-7153	Aro	25-25439	1
18-2009	Retén	26-89236	1
18-7426	Aro	25-30271	1
18-2945	Junta tornillo drenaje	12-20260, 12-19183	2



18-2697-1
KIT RETENES PARTE INFERIOR
 Reemplaza: 26-41365A3

— CONTIENE —

Ref #	Descripción	O.E.#	Cant.
18-0581	Retén	26-413651	2
18-0584	Retén	26-66022	1
18-0585	Retén	26-821928	1
18-0586	Retén	26-99325	1
18-2728	Retén tubo agua	26-42102-1	1
18-2945	Arandela	12-19183	2
18-3149-1	Base bomba de agua	46-42040A5	1
18-4261	Arandela	19643	1
18-7162	Aro	25-33145	1



18-74501
KIT RETÉN
ALOJAMIENTO
ENGRANAJE
 Reemplaza: 27-99049M
 Para: Mariner 9.9C & 15C modelos



18-74805
KIT RETENES
UNIDAD INFERIOR
 Reemplaza:
 27-804908A00
 Para: Mercury 8/9.9 4-tiempos (R042475 & Sup)



18-2725
KIT RETENES UNIDAD INFERIOR
 Reemplaza: 26-830749A01
 Para: 135/150/175 4-tiempos Verado (S/N 1B227000 & Sup), 200/225 4-tiempos Verado (S/N OT980000 & Sup), 250/275 4-tiempos Verado (S/N OT801000 & Sup)

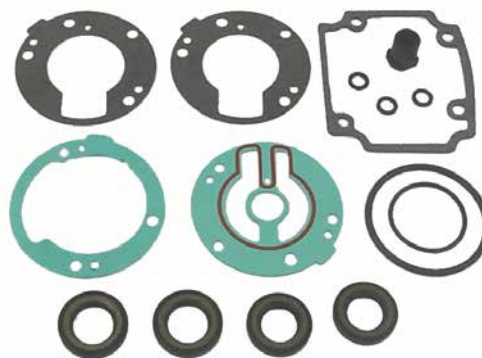

18-2785
KIT RETENES PARTE INFERIOR
 Reemplaza: 27-41899M

— CONTIENE —

Ref #	Descripción	O.E.#	Cant.
18-4698	Junta llenado/drenaje	27-81987M	3
18-0554	Retén aceite	26-84813M	1
18-0296	Retén aceite	26-854017M	2

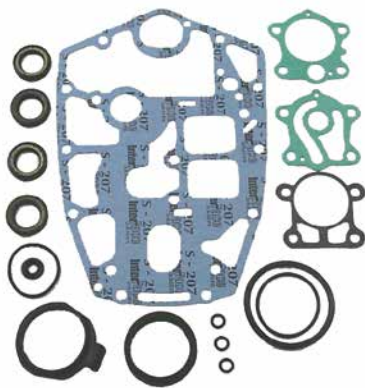

18-2787
KIT RETENES PARTE INFI
 Reemplaza: 27-92648M

— CONTIENE —

Ref #	Descripción	O.E.#	Cant.
18-4698	Junta llenado/drenaje	27-81987M	3
18-0296	Retén	26-854017M	2
18-0297	Retén	26-82234M	2
18-0298	Aro	25-82275M	1
18-0299	Aro	25-82289M	1
18-0292	Junta platina a alojamiento bomba	27-81417M	1
18-0267	Retén	26-82257M	1
18-0294	Junta platina a base bomba	27-81421M	1

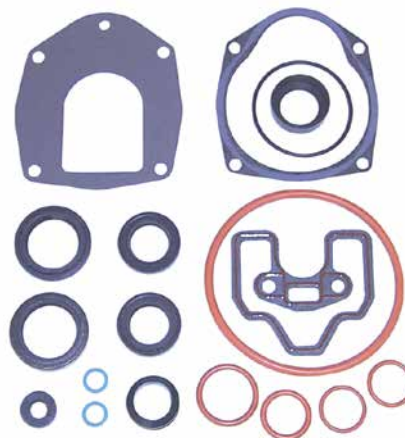

18-8382
KIT RETENES UNIDAD INFERIOR
 Reemplaza: 26-816575A4

Para: 200 HP (T801000 & Sup), 200 HP OPTIMAX DFI (G438000 & Sup), 225 HP EFI (G438000 & Sup), 225 HP OPTIMAX DFI (G590000-G960499), 250 HP EFI (G438000 & Sup), MODELS WITH "C-3 CASTING": 200 HP OPTIMAX DFI (G386496-G437999), 225 HP (D280813-G437999), 225 HP EFI (G129222-G437999), 250 HP EFI (G129222-G437999)

APLICACIONES KITS RETENES ALOJAMIENTO ENGRANAJE

HP	Desde n° serie #	Hasta n° serie #	Ref #	HP	Desde n° serie #	Hasta. n° serie #	Ref #
4 (1cil)	5595532	A809600	18-2628	60 (3 cil)	6428681	D000749	18-2654
4.5 (1 cil)	4107220	& SUP	18-2628	60 (3 cil)			
6	A197112	& SUP	18-2697-1	non-Bigfoot	D000750	& SUP	18-2635
7.5	4851693	& SUP	18-2628	60 (3 cil)			
8	A197112	& SUP	18-2697-1	Bigfoot	D000750	& SUP	18-2626
8 Bodensee (4-tiempos)	G760300	T178499	18-2697-1	60 (4-tiempos) Bigfoot	T178500	& SUP	18-2626
9.8	4839254	& SUP	18-2628	60 (4-tiempos)			
9.9	A197112	& SUP	18-2697-1	no-Bigfoot	T178500	& SUP	18-2635
9.9 (4-tiempos) no-Bigfoot	G760300	& SUP	18-2697-1	60 Seapro/ Marathon/ Big Foot (3 cil)	D000750	& SUP	18-2626
9.9 (4-tiempos) Bigfoot	G760300	& SUP	18-2624	70	4571652	A996141	18-2654
Seapro/XR10	D038000	& SUP	18-2697-1	70	A996142	& SUP	18-2626
15	A197112	& SUP	18-2697-1	75 (4 cil)	6432901	& SUP	18-2653
15 (4-tiempos) no-Bigfoot	G760300	& SUP	18-2697-1	75 (3 cil)	A996142	& SUP	18-2626
15 (4-tiempos) Bigfoot	G760300	& SUP	18-2624	75 (4-tiempos)	G960500	& SUP	18-2626
Magnum/ Marathon 15XD/ Super 15	TODOS		18-2624	80 (4 cil)	4831999	6432900	18-2653
18	5837437	6443972	18-2629	80 (3 cil)	A966142	& SUP	18-2626
18	6443973	& SUP	18-2624	90 (6 cil)	4845301	& SUP	18-2653
20	4709593	6443972	18-2627	90 (3 cil)	A996142	& SUP	18-2626
20	6443973	& SUP	18-2624	90 (4-tiempos)	G960500	& SUP	18-2626
25	5705532	6443972	18-2629	100 (4 cil)	B209468	& SUP	18-2626
25	6443973	& SUP	18-2624	115 (6 cil)	4855153	B209467	18-2653
25 Lightning (3 cil)	E268781	& SUP	18-2624	115 (4 cil)	C100000	& SUP	18-2626
30 (4-tiempos) (3 cil) Bigfoot	G760300	& SUP	18-2626	115EFI (4-tiempos)	T178500	& SUP	18-2626
35	6445653	& SUP	18-2654	125 (4 cil)	D283222	& SUP	18-2626
40 (2 cil)	4860103	G053313	18-2654	V-135	A904646	& SUP	18-2655
40 (4 cil)	C159200	& SUP	18-2654	V-135 DFI	G590000	& SUP	18-2655
40 (4-tiempos) (3 cil) Bigfoot	G760300	& SUP	18-2626	140 (6 cil)	4865678	& SUP	18-2653
45	5531630	& SUP	18-2654	V-150	4868648	A904645	18-2653
50 (4 cil)	4357640	& SUP	18-2654	V-150 (carb)	A904646	& SUP	18-2655
50 (3 cil)	6428681	D000749	18-2654	V-150 XR4, XR6, MAGII, III	B242885	& SUP	18-2655
50 (3 cil)	D000750	G589999	18-2635	V-150 EFI	D820000	& SUP	18-2655
50 (4-tiempos) (4 cil) Bigfoot	G760300	& SUP	18-2626	V-150 DFI	G590000	& SUP	18-2655
50 (4-tiempos) Bigfoot	G231123	& SUP	18-2626	V-175	4301235	6618750	18-2653
50 (4-tiempos) no-Bigfoot	T178500	& SUP	18-2635	V-175 (carb)	6618751	& SUP	18-2655
55 (3 cil)	D000750	& SUP	18-2635	V-175 XRI(EFI)	D000750	& SUP	18-2655
				V-200	4839034	6625220	18-2653
				V-200 (carb)	6625221	& SUP	18-2655
				V-200 XRI(EFI)	C100861	& SUP	18-2655
				V-200 DFI (3.0L)	G386496	G960499	18-2642
				V-220	B117316	& SUP	18-2655
				V-225	5628028	& SUP	18-2653
				V-225	D280813	& SUP	18-2646-1
				V-225/225 DFI	G386496	& SUP	18-2642
				V-250	G386496	& SUP	18-2642

KIT RETENES UNIDAD INFERIOR MARINER (Modelos japoneses)

Modelo	Serie #	O.E. Kit #	Ref #
20C	(6A9-) TODOS	27-41899M/27-95660M	18-2785
25C	(695-) TODOS	27-41899M/27-95660M	18-2785
30A	(689-) TODOS	27-41899M/27-95660M	18-2785
W48	(670-) TODOS	27-92648M	18-2787
55/W55	(663-) TODOS	27-92648M	18-2787
60	(675-) TODOS (6F0-) TODOS	27-92648M	18-2787

Retenes Aceite



Ref #	O.E. #	Tamaño Eje (pulgadas.)	Dimensiones		Ref #	O.E. #	Tamaño Eje (pulgadas.)	Dimensiones	
			d. ext	ancho (pulgadas)				d. ext	ancho (pulgadas)
18-0172	26-97530	0.845	1.500	0.315	18-0531	26-72785	0.790	1.880	0.248
18-0267	26-82257M	0.354	0.748	0.197	18-0537	26-85107	1.020	1.507	0.251
18-0296	26-854017M	0.866	1.417	0.236	18-0554	26-84813M	0.787	1.339	0.260
18-0297	26-82234M	0.906	1.457	0.236	18-0560 ③	26-888483	1.250	1.690	0.256
18-0515	26-30530	0.540	1.004	0.303	18-0564 ④	26-888483	1.250	1.690	0.256
18-0516	26-30913	0.500	0.839	0.187	18-0579	26-41131	1.141	1.313	0.344
18-0517	26-32911	1.100	1.260	0.127	18-0580	26-41132	0.750	1.250	0.312
18-0518 ②	26-34217	0.282	0.394	0.083	18-0581	26-413651	0.500	0.984	0.200
18-0519	26-14240	3.792	4.536	0.482	18-0583	26-43035	1.063	1.496	0.197
18-0522	26-43036	1.045	1.474	0.187	18-0584	26-66022	0.056	1.000	0.312
18-0523	26-43993	1.640	2.132	0.282	18-0585	26-821928	0.687	1.125	0.312
18-0525	26-45587	0.390	0.628	0.124	18-0586	26-99325	0.675	1.125	0.250
18-0526	26-48443	0.750	1.379	0.256	18-0595	26-66303	0.688	1.125	0.250
18-0527	26-56397	0.750	1.127	0.343	18-2002	26-76868	1.188	1.692	0.250
18-0529	26-62818	1.640	2.256	0.319	18-2004	26-20070	0.625	1.000	0.250
					18-2006	26-897154	0.625	1.125	0.312
					18-2008	26-56788	0.875	1.250	0.375
					18-2010	26-897153	0.437	0.875	0.250
					18-2017	26-32121	0.750	1.000	0.125
					18-2053	26-70081	1.185	1.754	0.360
					18-8308	26-30696	0.297	0.625	0.156
					18-8310	26-30900T	0.453	0.828	0.172
					18-8347	26-8164641	0.750	0.375	0.243

① Retén ② Env. de 4 ③ Metal ④ Goma

APLICACIONES RETENES

HP	Cil.	Desde N° serie.	Hasta N° serie.	Cigüeñal superior	Cant.	Cigüeñal inferior	Cant.
3.5	1	6202173	SUP	-	-	18-0527	1
3.6	1	5404657	SUP	-	-	18-0527	1
4	1	2771622	4107219	-	-	18-0527	1
4	1	5589202	SUP	18-0515	1	-	-
4.5	1	4107220	SUP	-	-	18-0527	1
7.5/9.8/110	2	2810637	3274633	-	-	18-0527	1
10/15/20/25	2	1290910	1499331	-	-	18-2013	1
20	2	1558310	2031773	-	-	18-2013	2
20	2	2031774	2827677	-	-	18-2013	2
18,20,25XD	2	6443973	SUP	-	1	18-0537	1
20 JET	2	G053314	SUP	-	1	18-0537	1
30	2	1271885	1356947	18-2016	1	18-2016	1
30JET	2	C159200	SUP	18-2016	1	18-2016 ①	2
MK 35 A	2	1217222	1271884	18-2016	1	18-2016	1
35	2	1356948	1571113	18-2016	1	18-2016	1
35	2	1571114	2874703	-	-	18-2016 (Inferior)	1
35	2	6445653	SUP	18-2016	1	18-2016	2
40	4	1279685	2874703	18-2016	1	18-2016	1
40	2	2874704	3336257	18-2016	1	18-2016	2
40	2	3336258	4117709	18-2016	1	18-2016	1
40	2	4117710	5556229	18-2016	1	18-2016	1
40	2	5556230	6445653	18-2016	1	18-2016	2
40	4	C159200	SUP	18-2016	1	18-2016 ①	2
45	4	1476510	1531568	18-2016	1	18-2016	1
45	4	5531630	SUP	18-2016	1	18-2016	2
45 JET	3	Todos	-	-	-	18-2016 (inf.)	1
50	4	1421113	2858813	18-2016	1	18-2016 (inf.)	1
50	4	2855514	SUP	18-2016	1	18-2016	2
50/60	3	6428681	D000750	18-2016	1	18-2016	2
50/55/60	3	D000750	SUP	-	-	18-2016 (inf.)	1
60	6	1303411	1542744	18-2016	1	18-2016	1
65	4	1542745	2803561	18-2016	1	18-2016 (inf.)	1
65	4	2803562	3293183	18-2016	1	18-2016	2
65	3	3293184	3547986	18-2016	1	18-2016	2
65	3	3547987	4571651	18-2016	1	18-2016	2
65 JET	3	D283222	SUP	18-0523	1	18-2016	1

① Para mayoría modelos

APLICACIONES RETENES (Cont.)

HP	Cil.	Desde n° Serie.	Hasta n° serie.	Cigüeñal Superior	Cant.	Cigüeñal Inferior	Cant.
70	6	1296411	1566239	18-2016	1	18-2016 (Int.)	1
70	3	4571652	6428680	18-2016	1	18-2016	2
70	3	A996142	SUP	18-0523	1	18-2016	1
75	4	6432901	A996141	18-2016	1	18-2016	2
75	3	A996142	D283221	18-0523	1	18-2016	1
75	3	D283222	SUP	18-0523	1	18-2016	1
80	6	1335465	1566239	18-2016	1	18-2016	1
80	4	2559001	4831998	18-2016	1	18-2016	2
80	4	4831999	SUP	18-2016	1	18-2016	2
80	3	A996142	SUP	18-0523	1	18-2016	1
80 JET	4	D283222	SUP	18-0523	1	18-2016	1
85	6	1460999	1766823	18-2016	1	18-2016	1
85	4	3493913	4831998	18-2016	1	18-2016	2
90	6	1766824	1869775	18-2016	1	18-2016 (ext.)	1
90	6	4845301	A996141	18-2016	1	18-2016	2
90	3	A996142	D283221	18-0523	1	18-2016	1
90	3	D283221	SUP	18-0523	1	18-2016	1
95	6	1869776	2318585	18-2016	1	18-2016 (int.)	1
100	6	1464949	2836018	18-2016	1	18-2016	1
100BP	6	2641855	3253111	18-2016	1	18-2016	2
100	4	B209468	D283221	18-0523	1	18-2016	1
100	4	D283222	SUP	18-0523	1	18-2016	1
105JET	V-6	D082000	SUP	18-2016	1	18-2016	2
110	6	1870204	2314955	18-2016	1	18-2016	1
115	6	2836019	3525440	18-2016	1	18-2016	2
115	6	3525441	C100000	18-2016	1	18-2016	2
125	6	2314956	3253111	18-2016	1	18-2016 (int.)	1
135	6	2839369	3293233	18-2016	1	18-2016	2
135	V-6	A904646	SUP	18-2016	1	18-2016	2
140	6	3293234	SUP	18-2016	1	18-2016	2
140JET	V-6	D082000	SUP	18-2016	1	18-2016	2
150	6	3502806	5327662	18-2016	1	18-2016	2
150	V-6	4868998	6042945	18-2016	1	18-2016	2
150	V-6	6042946	SUP	18-2016	1	18-2016	2
175	V-6	4301235	5875203	18-2016	1	18-2016	2
175	V-6	5875204	6618751	18-2016	1	18-2016	2
175	V-6	6618751	SUP	18-2016	1	18-2016	2
200	V-6	4839034	5875303	18-2016	1	18-2016	2
200	V-6	5875303	6073191	18-2016	1	18-2016	2
200	V-6	6073192	SUP	18-2016	1	18-2016	2
220	V-6	B117316	SUP	18-2016	1	18-2016	2
225	V-6	5628028	SUP	18-2016	1	18-2016	2

① Adapta a mayoría mod.

APLICACIONES RETENES UNIDAD INFERIOR

HP	Desde N° Serie.	Hasta N° Serie.	Eje hélice Interno/Externo	Base bomba de agua Superior/ Inferior	Alojamiento Bomba agua	Eje Cambio
3.5/3.6	5404657	SUP	-	18-2010	18-0516	-
3.9	1655013	2498135	18-0515	-	18-0516	-
4	2498136	5589201	18-0515	-	18-0516	-
4	5589202	5595531	-	18-2010	18-0516	-
4/4.5	5589203	A809601	-	18-2010	② 18-0516	-
6	1408611	2529894	18-0515	-	18-0516	-
7.5	2529895	3801457	18-0515	-	18-0516	-
7.5	3801458	5206549	-	-	18-0516	-
7.5	5206550	SUP	-	18-2010	② 18-0516	-
9.8	1470349	3795657	18-0515	-	18-0516	-
9.8	3795658	5206549	-	-	18-0516	-
9.8	5206550	SUP	-	18-2010	② 18-0516	-
18	5837437	6443972	-	18-2006/18-2006	-	-
20	1558310	1866494	18-2019/18-2019	18-2006	18-2004	-
20	1866495	6443972	18-2019/18-2019	18-2004/18-2006	18-2004	-
25	5705532	6443972	-	18-2006/18-2006	-	-
30	1271885	1356947	18-2011	18-2011	18-2015	18-2009
30	G055314	SUP	18-2051/18-2052	-	-	-
MK 35A	1217222	1271884	18-2011	18-2011	18-2015	18-2009
35	1356948	1448139	18-2011	18-2011	18-2015	18-2009
35	1571114	1960826	18-2011	18-2011	18-2017	18-2009
35	1960827	2874703	18-2011/18-2015	18-2011/18-2055	18-2017	18-2009
35	6445653	SUP	18-2051/18-2052	18-2011/18-2055	-	18-2054
40	1279685	2874703	18-2011	18-2011	18-2015	18-2009
40	2874704	3336257	18-2008	18-2011/18-2055	18-2017	18-2009
40	3336258	4117709	18-2008	18-2011/18-2055	18-2017	18-2048
40	4117710	4860102	18-2051/18-2052	18-2011/18-2055	-	18-2009/18-2048

② .438 DI solo

APLICACIONES RETENES UNIDAD INFERIOR (Cant.)

HP	Desde nº serie.	Hasta nº serie.	Eje hélice Int/Ext	Base bomba agua Superior/Inferior	Alojamiento Bomba agua	Eje cambio
40	4860103	6445652	18-2051/18-2052	18-2011/18-2055	-	18-2054
40 4cil	C159200	G053313	18-2051/18-2052	18-2011/18-2055	-	18-2054
40 2cil	G055314	SUP	18-2051/18-2052	-	-	-
45	1476510	1531568	18-2011	18-2011	18-2017	18-2009
45 4cil	5531630	SUP	18-2051/18-2052	18-2011/18-2055	-	18-2054
50	1421113	1639472	18-2011	18-2011	18-2017	18-2009
50	1639473	1770178	18-2011	18-2011	18-2017	18-2009
50	1770179	2305100	18-2011/18-2015	18-2011/18-2055	18-2017	18-2009
50	2305101	2858813	18-2011/18-2015	18-2011/18-2055	18-2017	18-2048
50	2858814	4140999	18-2008	18-2011/18-2055	18-2017	18-2009/18-2048
50	4141000	4962055	18-2051/18-2052	18-2011/18-2055	-	18-2009/18-2048
50	4962056	5531630	18-2051/18-2052	18-2011/18-2055	-	18-2054
50 3cil	6428681	D000750	18-2051/18-2052	18-2011/18-2055	-	18-2054
50/55/60 3 cil	D000751	SUP	18-2051/18-2052	-	-	18-2054
60	1303411	1542744	-	18-2011	18-2015	-
60	6428681	D000750	18-2051/18-2052	18-2011/18-2055	-	18-2054
65	1542745	2874263	18-2002/18-2002	18-2007	18-2013	18-2009
65	2874263	3293183	18-2002/18-2002	18-2007/18-2050	18-2013	18-2009/18-2048
65 3cil	3293184	4136684	18-2008	18-2011/18-2055	18-2017	18-2009/18-2048
65 3cil	4136685	4571651	18-2051/18-2052	18-2011/18-2055	18-2017	18-2009/18-2048
70	1296411	1413610	18-2011	-	18-2015	-
70	1413611	1566239	18-2002/18-2002	18-2007	18-2013	18-2009
70 3cil	4571652	4977156	18-2051/18-2052	18-2011/18-2055	-	18-2009/18-2048
70 3cil	4977157	5579016	18-2051/18-2052	18-2011/18-2055	-	18-2054
70 3cil	5579017	A996142	18-2051/18-2052	18-2011/18-2055	-	18-2009
70/75 3cil	A996142	SUP	18-2002/18-2053	18-0522 (inferiores)	-	--
75 4cil	6432901	A996142	18-2002/18-2053	18-2013/18-2007	-	18-2054
80	1335465	1398629	18-2002/18-2002	18-2007	18-2013	18-2009
80	1398630	1566239	18-2002/18-2002	18-2007	18-2013	18-2009
80 4cil	2559001	3144218	18-2002/18-2002	18-2013/18-2007	18-2013	18-2009/18-2048
80 4cil	3144219	4831998	18-2002/18-2002	18-2050/18-2007	18-2013	18-2009/18-2048
80 4cil	4831999	5582561	18-2002/18-2002	18-2013/18-2007	-	18-2054
80 4cil	5582562	A996142	18-2002/18-2053	18-2013/18-2007	-	18-2054
80 3cil	A996142	SUP	18-2002/18-2053	18-0522 (Inferiores)	-	--
85	1460999	1766823	18-2002/18-2002	18-2007	18-2013	18-2009
85 4cil	3493913	4590511	18-2002/18-2002	18-2050/18-2007	-	18-2009/18-2048
85 4cil	4590512	4831998	18-2002/18-2002	18-2013/18-2007	-	18-2009/18-2048
90	1766824	1869775	18-2002/18-2002	18-2013/18-2007	18-2013	18-2009
90	4845301	5594656	18-2002/18-2002	18-2013/18-2007	-	18-2054
90	5594657	A996142	18-2002/18-2053	18-2013/18-2007	-	18-2054
90 3cil	A996142	SUP	18-2002/18-2053	18-0522 (Inferiores)	-	--
95	1869776	2318585	18-2002/18-2002	18-2013/18-2007	18-2013	18-2009/18-2048
100,100SS	1464949	2836018	18-2002/18-2002	18-2013/18-2007	18-2013	18-2009
100BP	2399698	2641854	18-2002/18-2002	18-2013/18-2007	18-2013	18-2009/18-2048
100 4cil	B209468	SUP	18-2002/18-2053	18-0522 (Inferiores)	-	--
110	1870204	2314955	18-2002/18-2002	18-2013/18-2007	18-2013	18-2009/18-2048
115	2836019	3525440	18-2002/18-2002	18-2013/18-2007	18-2013	18-2009/18-2048
115	3525440	4112634	18-2002/18-2002	18-2013/18-2007	-	18-2009/18-2048
115	4112635	4855152	18-2002/18-2002	18-2013/18-2007	-	18-2009/18-2048
115	4855153	5600966	18-2002/18-2002	18-2013/18-2007	-	18-2054
115	5600967	C100000	18-2002/18-2053	18-2013/18-2007	-	18-2054
115 4cil	C100000	SUP	18-2002/18-2053	18-0522 (Inferiores)	-	--
125	2314956	2839368	18-2002/18-2002	18-2013/18-2007	18-2013	18-2009
135	2839369	3293233	18-2002/18-2002	18-2013/18-2007	18-2013	18-2009
140	3293234	3502805	18-2002/18-2002	18-2013/18-2007	18-2013	18-2009/18-2048
140	4865678	SUP	18-2002/18-2002	18-2013/18-2007	-	18-2054
150	3502806	4121434	18-2002/18-2002	18-2013/18-2007	-	18-2009/18-2048
150	4121434	5327662	18-2002/18-2002	18-2013/18-2007	-	18-2009/18-2048

V-6'S

150/150XR2	4868998	5432021	18-2002/18-2002	18-2013/18-2014	-	18-2054
150/150XRS	5432021	A904646	18-2002/18-2002	18-2013/18-2014	-	18-2054
135/150/XR2	A904646	SUP	18-2002/18-2002	18-2013/18-2014	-	18-2054
175	4301235	6618750	18-2002/18-2002	18-2013/18-2014	-	18-2054
175	6618751	SUP	18-2002/18-2002	18-2013/18-2014	-	18-2054
200	4839034	6073191	18-2002/18-2002	18-2013/18-2014	-	18-2054
200	6073192	SUP	18-2002/18-2002	18-2013/18-2014	-	18-2054
220	B117316	SUP	18-2002/18-2002	18-2013/18-2014	-	18-2054
225	5628028	D280813	18-2002/18-2002	18-2013/18-2014	-	18-2054
250/275	C101891	SUP	18-2002/18-2002	-	-	18-2054
3.4	5611648	SUP	18-2002/18-2002	-	-	18-2054

RETÉN ACEITE POWER TRIM

H.P.	Desde S/N	Hasta S/N	Retenes Aceite	Cant.	Descripción
115	2836019	3525440	18-2048	1	Soporte montaje estribor
140	3293234	SUP	18-2048	1	Soporte montaje estribor
150	3502806	4865677	18-2048	1	Soporte montaje estribor
150 XS	4868648	5327662	18-2048	1	Soporte montaje estribor

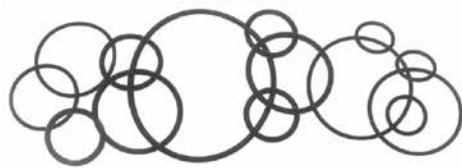

AROS

Ref #	O.E. #	Dimensiones		Ref #	O.E. #	Dimensiones	
		D.I.	Ancho (pulgadas)			D.I.	Ancho (pulgadas)
18-0175 ③④	25-26543	.220	.103	18-7164 ②④	25-33466	1.375	.100
18-0858 ③④	25-54029	2.425	.103	18-7165 ②④	25-45253	.500	.065
18-0860 ③④	25-62700	3.237	.103	18-7165 ②④	25-32509	.500	.065
18-7102 ②④	25-62706	.426	.070	18-7166 ②④	25-45254	.615	.065
18-7103 ②④	25-29845	.924	.103	18-7167 ②④	25-861844	3.609	.139
18-7105 ②④	25-62705	.750	.065	18-7168 ②④	25-48171	.370	.065
18-7107 ②④	25-67202	4.750	.135	18-7169 ②④	25-70937	3.500	.135
18-7114 ②④	25-23145	1.000	.135	18-7170 ②④	25-33504	1.365	.135
18-7115 ①	25-26722	1.735	.135	18-7171 ②④	25-30529	1.920	.100
18-7116 ①	25-62704	.360	.100	18-7172 ②④	25-31305	3.250	.135
18-7117 ①	25-35027	1.046	.139	18-7173 ②④	25-30224Q	1.875	.135
18-7120 ①	25-38933	.215	.065	18-7174 ②④	25-45711	.620	.100
18-7121 ①	25-35029	3.100	.135	18-7175 ②④	25-62817	3.750	.270
18-7124		2.500	.103	18-7176 ②④	25-896523	2.160	.100
18-7125		2.300	.103	18-7177 ②④	25-53421	2.625	.065
18-7135 ①	25-35276	.750	.135	18-7180 ②④	25-26802	.445	.090
18-7143 ②④	25-65936	1.310	.100	18-7188 ②	25-805726	.361	.0635
18-7145 ②④	25-64068	.250	.100	18-7198 ②④	25-45710	1.430	.100
18-7146 ②④	25-47632	1.120	.100	18-7411 ②④	25-35480	1.250	.100
18-7151 ②④	25-20081	3.000	.135	18-7413 ②④	25-62702	.301	.070
18-7152 ②④	25-20863	2.625	.135	18-7414 ②④	25-823683	1.989	.070
18-7153 ②④	25-21836	.862	.103	18-7415 ②④	25-64966	3.739	.070
18-7155 ②④	25-26855	1.620	.135	18-7419 ②④	25-69202	2.675	.103
18-7156 ②④	25-29439	1.185	.100	18-7420 ②④	25-25439	.862	.139
18-7157 ②④	25-29976	3.500	.210	18-7421 ②④	25-16524	.150	.065
18-7158 ②④	25-30613	.740	.100	18-7426 ③④	25-30271	.740	.310
18-7159 ②④	25-31534	3.855	.210	18-7440-1 ③	25-36318	.799	.103
18-7160 ②④	25-31986	2.635	.210	18-7445 ③④	25-55801	.801	.070
18-7161 ②④	25-32546	3.250	.070	18-7449 ①	25-97387	4.487	.103
18-7162 ②④	25-33145	2.025	.135	18-7459 ①	25-20826	2.234	.139
18-7163 ②④	25-33465	2.415	.100	18-7464 ①	25-39695	4.234	.139
				18-7467 ②④	25-54030	2.987	.103
				18-7474 ①	25-94288	1.239	.070
				18-7956 ③④	25-85549	2.480	.1969
				18-7100 ②④	25-85594	.2362	.1575
				18-7961	25-47254	3.650	.135
				18-76695	25-803513007		

① Env. de 1 ② Env. de 5 ③ Env. de 2

AROS MARINER (Modelos Japoneses)

Ref.	O.E. No.	Dimensiones		Ref.	O.E. No.	Dimensiones	
		D. I.	Ancho (mm)			D. I.	Ancho (mm)
18-0298	25-82275M	41.50	3.0	18-0299	25-82289M	66.04	5.33

APLICACIONES AROS Y RETENES

Modelo	Desde nº Serie #	Hasta nº Serie #	Aro tórico inf.	Retén aceite inf.	Aro tórico sup.	Retén aceite sup.
3.5 (1cil)	6202173	& SUP	N/D	N.L.A.	18-7152	N/D
3.9 (39) (1cil)	1655013	2498135	N/D	N.L.A.	18-7152	N.L.A.
4 (1cil)	1655013	2498135	N/D	N/D	18-7152	N/D
4 (40) (1cil)	2498136	2693114	N/D	N.L.A.	18-7152	N.L.A.
4 (1cil)	2771622	4107219	N.L.A.	N/D	18-7152	N.L.A.
4 (40) (2cil)	5589202	& SUP	18-7102	N/D	N/D	18-0515
4.5 (4.5, 45) (1cil)	4107220	4597261	N/D	N/D	18-7152	N.L.A.
4.5 (4.5, 45) (1cil)	4597262	5595531	N/D	N.L.A.	18-7152	N/D
4.5 (4.5, 45) (1cil)	5595532	& SUP	N/D	N.L.A.	18-7152	N/D
6 (60)	1916139	2529894	N/D	N.L.A.	18-7459	N.L.A.
6 (2cil)	1408611	2529894	N/D	N/D	18-7152	N/D
7.5 (75)	2529895	2721150	N/D	N.L.A.	18-7152	N.L.A.
7.5 (2cil)	2810637	3801457	N/D	N.L.A.	18-7152	N/D
7.5 (75) (2cil)	3274633	& SUP	N/D	N/D	18-7152	N/D
7.5 (7.5, 75)	3801458	& SUP	N/D	N/D	18-7152	N/D
9.8 (110)	1865779	2798056	N/D	N.L.A.	18-7152	N.L.A.
9.8 (110)	2798057	3795657	N/D	N.L.A.	18-7152	N/D
9.8 (2cil)	2810637	3274633	N/D	N/D	18-7152	N/D
9.8 (9.8, 110)	3795658	& SUP	N/D	N/D	18-7152	N/D
9.8 (2cil)	3274633	& SUP	N/D	N/D	18-7152	N/D
10 (100)	1290910	1499331	N/D	18-2026	N.L.A.	N.L.A.
110 (2cil)	2810637	3274633	N/D	N/D	18-7152	N/D
110 (2cil)	3274633	& SUP	N/D	N/D	18-7152	N/D
15 (150)	1290910	1499331	N/D	18-2026	N.L.A.	N.L.A.
15 (SEA PRO)	G044365	G437999	N/D	18-0537	N/D	N/D
15 (SEA PRO)	G438000	& SUP	N/D	26-12566 1	N/D	N/D
15 (SUPER)	B238464	& SUP	N/D	18-0537	N/D	N/D
15 (18, 18XD)	5837437	& SUP	N/D	18-0537	N/D	N/D
20 (200)	1290910	1499331	N/D	18-2026	N.L.A.	N.L.A.
20 (200)	1558310	2031773	N/D	18-2026	N.L.A.	N/D

④ Precio por pieza. Para pedir envasado añada 9 al final de la referencia.

APLICACIONES AROS Y RETENES (Cont.)

Modelo	Desde n° Serie #	Hasta n° Serie #	Aro tórico inf.	Retén aceite inf.	Aro tórico sup.	Retén aceite sup.
20 (2cil)	2031774	2827677	N/D	N/D	18-7151	N/D
20 (20, 200)	2827677	6443972	N/D	18-2056	18-7151	N/D
20 (20, 20XD)	6443973	T800749	N/D	18-0537	N/D	N/D
20 JET	G044027	& SUP	N/D	18-0537	N/D	N/D
25 (250)	1290910	1499331	N/D	18-2026	N.L.A.	N.L.A.
25 (25, 25XD) (2cil)	5705532	& SUP	N/D	18-0537	N/D	N/D
30 (2cil)	1271885	1448139	18-7151	N.L.A.	18-7151	18-2016
30 (2cil) 644cc	G053314	& SUP	18-7176	18-2016	N/D	N/D
30 (2cil) 430cc	G575500	& SUP	N/D	18-2016	N/D	N/D
30 JET (4cil)	C159200	D279349	18-7161	18-2016	18-7151	18-2016
30 JET (4cil)	D279350	& SUP	18-7161	18-2016	18-7151	18-2016
30 JET (3cil)	G531301	& SUP	18-7176	18-2016	N/D	N/D
MK 35A (2cil)	1217222	1271884	18-7151	N/D	18-7151	N/D
35 (350)	1271884	1448139	18-7151	N.L.A.	18-7151	18-2016
35 (2cil)	1356948	1571113	18-7151	N/D	18-7151	N/D
35 (2cil)	1571114	2874703	18-7151	N/D	18-7172	N.L.A.
35 (2cil)	6445653	& SUP	18-7414	18-2016	18-7167	18-2016
40 (402) (2cil)	1279685	1476509	18-7151	N/D	18-7151	18-2016
40 (4cil)	1279685	2874703	18-7151	N/D	18-7151	N/D
40 (2cil)	2874704	3336257	N/D	18-2016	18-7167	18-2016
40 (2cil)	3336258	3346479	N/D	18-2016	18-7961	18-2016
40 (2cil)	3336258	4117709	N/D	N/D	18-7167	N/D
40 (2cil)	4117710	& SUP	18-7414	18-2016	18-7167	18-2016
40 (2cil)	5556230	6445653	18-7414	N/D	18-7167	N/D
40 (4cil)	C159200	D279349	18-7161	18-2016	18-7151	18-2016
40 (402) (2cil)	3477010	4117709	N/D	18-2016	N/D	18-2016
40 (2cil) 644cc	G053314	& SUP	18-7176	18-2016	N/D	N/D
40 (4cil)	D279350	& SUP	18-7161	18-2016	18-7151	18-2016
40 (3cil)	G531301	& SUP	18-7176	18-2016	N/D	N/D
45 (450) (4cil)	1476510	1531568	18-7151	N.L.A.	18-7151	18-2016
45 (4cil)	5531630	& SUP	18-7151	18-7151	18-7151	18-2016
45 JET	D000750	G589999	18-7176	18-2016	18-7176	N/D
45 JET	G590000	& SUP	18-7176	18-2016	N/D	N/D
50 (500) (4cil)	1421113	1639472	18-7151	18-7151	18-7151	18-2016
50 (500) (4cil)	1639473	2858813	18-7151	N/D	18-7151	18-2016
50 (50, 500) (4cil)	2855514	& SUP	18-7151	18-2016	18-7151	18-2016
50 (3cil)	D000750	G589999	18-7176	18-2016	N/D	N/D
50 (3cil)	6428681	D000750	18-7161	18-2016	18-7415	18-2016
50 (3cil)	D000750	& SUP	18-7176	N/D	N/D	N/D
50 (3cil)	G590000	& SUP	18-7176	18-2016	N/D	N/D
55 (3cil)	D000750	G589999	18-7176	18-2016	N/D	N/D
55 (3cil)	G590000	& SUP	18-7176	18-2016	N/D	N/D
60 (3cil)	6428681	D000749	18-7161	18-2016	18-7415	18-2016
60 (3cil)	D000750	& SUP	18-7176	N/D	N/D	N/D
60 (600) (4cil)	1303411	1542744	18-7151	N/D	18-7151	18-2016
60 (3cil)	D000750	G589999	18-7176	18-2016	N/D	N/D
65 (650) (4cil)	1542745	2803561	18-7151	N/D	18-7172	18-2016
65 (650) (4cil)	2803562	3203183	18-7151	18-2016	18-7172	18-2016
65 (650) (3cil)	3293184	4571651	18-7161	18-2016	18-7167	18-2016
65 (3cil)	3547987	4571651	18-7161	N/D	18-7415	N/D
65 JET	D283222	& SUP	N/D	18-2016	18-7414	18-0523
70 (700) (6cil)	1296411	1566239	18-7151	N/D	18-7151	18-2016
70 (3cil)	4571652	6428680	18-7161	18-2016	18-7415	18-2016
70 (3cil)	A996142	B240450	N/D	18-2016	18-7414	18-0523
70 (3cil)	B240451	& SUP	18-0858	18-2016	18-7414	18-0523
75 (4cil)	6432901	& SUP	18-7161	18-2016	18-7961	18-2016
75 (3cil)	C222000	& SUP	N/D	18-2016	18-7414	18-0523
80 (800) (6cil)	1335465	1566239	18-7151	N/D	18-7151	18-2016
80 (800) (4cil)	2559001	3493912	18-7151	18-2016	18-7961	18-2016
80 (80, 800) (4cil)	4831999	6432900	18-7161	18-2016	18-7961	18-2016
80 (3cil)	A996142	B240450	N/D	18-2016	18-7414	18-0523
80 (3cil)	B240451	& SUP	18-0858	18-2016	18-7414	18-0523
80 JET	D283222	G760299	N/D	18-2016	18-7414	18-0523
80 JET Aro superior redondo	G760300	& SUP	N/D	18-2016	18-7414	18-0523
80 JET Aro superior cuadrado	G760300	& SUP	N/D	18-2016	N/D	18-0523
85 (850) (6cil)	1460999	1464848	18-7151	N/D	18-7151	18-2016
85 (850) (6cil)	1566240	1766823	18-7151	N/D	N.L.A.	18-2016
85 (850) (4cil)	3493913	4831998	18-7161	18-2016	18-7961	18-2016
90 (900) (6cil)	1766824	1869775	18-7151	N/D	N.L.A.	18-2016
90 (90, 900) (6cil)	4845301	& SUP	18-7161	18-2016	18-7961	18-2016
90 (3cil)	A996142	B240450	N/D	18-2016	18-7414	18-0523
90 (3cil)	B240451	C221999	18-0858	18-2016	18-7414	18-0523
90 (3cil)	C222000	& SUP	N/D	18-2016	18-7414	18-0523
95 (950) (6cil)	1869776	2318585	18-7151	N/D	N.L.A.	18-2016

APLICACIONES AROS Y RETENES (Cont.)

Modelo	Desde n° Serie #	Hasta n° Serie #	Aro tórico inf.	Retén aceite inf.	Aro tórico sup.	Retén aceite sup.
100 (1000) (6cil)	1464949	2318585	18-7151	N/D	N.L.A.	18-2016
100 (1000SS) (6cil)	2318586	2413847	18-7151	N/D	N.L.A.	18-2016
100 (1000SS) (6cil)	2484633	2836018	18-7151	18-2016	N.L.A.	18-2016
100 (1000BP) (6cil)	2399698	2641854	18-7151	18-2016	N.L.A.	18-2016
100 (1000BP) (6cil)	2641855	3253111	18-7151	18-2016	18-7961	18-2016
100 (4cil)	B209468	G760299	N/D	18-2016	18-7414	18-0523
100 w/Aro superior redondo	G760300	& SUP	N/D	18-2016	18-7414	18-0523
100 w/Aro superior cuadrado	G760300	& SUP	N/D	18-2016	25-858225	18-0523
110 (1100)	1870201	2314955	18-7151	N/D	N.L.A.	18-2016
115 (1150) (6cil)	2836019	3525440	18-7151	18-2016	18-7961	18-2016
115 (115, 1150) (6cil)	3525441	& SUP	18-7161	18-2016	18-7961	18-2016
115 (4cil)	C100000	G760299	N/D	18-2016	18-7414	18-0523
115 w/Aro superior redondo	G760300	& SUP	N/D	18-2016	18-7414	18-0523
115 w/Aro superior cuadrado	G760300	& SUP	N/D	18-2016	N/D	18-0523
115 DFI (1.5L)	T801000	& SUP	N/D	18-2016	N/D	N/D
115 PRO XS	B751825	& SUP	N/D	18-2016	N/D	N/D
125 (1250) (6cil)	2314956	2839368	18-7151	N/D	18-7961	18-2016
125 (4cil)	D283222	G760299	N/D	18-2016	18-7414	18-0523
125 w/ROUND UPPER O-RING (4cil)	G760300	& SUP	N/D	18-2016	18-7414	18-0523
125 w/SQUARE UPPER O-RING (4cil)	G760300	& SUP	N/D	18-2016	N/D	18-0523
135 (1350) (6cil)	2839369	3293233	18-7151	18-2016	18-7961	18-2016
140 (140, 1400) (6cil)	3293234	& SUP	18-7161	18-2016	18-7961	18-2016
150 (1500) (6cil)	3502806	4865677	18-7161	18-2016	18-7961	18-2016
150 (1500XS) (6cil)	4868648	5327662	18-7161	18-2016	18-7961	18-2016
V-105 JET	D082000	& SUP	18-0860	18-2016	18-0858	18-2016
V-135 CARB w1.50 ID Cojinete sup.	A904646	C100860	18-0860	18-2016	18-0858	18-2016
V-135 CARB w1.37 ID Cojinete sup.	A904646	C100860	18-0860	18-2016	18-0858	18-2016
V-135 CARB	C100861	& SUP	18-0860	18-2016	18-0858	18-2016
V-135 CARB	C239553	& SUP	18-0860	18-2016	18-0858	18-2016
V-135 DFI	G590000	& SUP	18-0860	18-2016	18-0858	18-2016
V-140 JET	D082000	& SUP	18-0860	18-2016	18-0858	18-2016
V-150 (V-1500) CARB	4868998	A904645	N/D	18-2016	N/D	18-2016
V-150 w/1.50 ID Cojinete sup.	A904646	C100860	18-0860	18-2016	18-0858	18-2016
V-150 w/1.37 ID Cojinete sup.	A904646	C100860	18-0860	18-2016	18-0858	18-2016
V-150 CARB	C100861	C239552	18-0860	18-2016	18-0858	18-2016
V-150 XR4 / MAGNUM II	B242885	C239552	18-0860	18-2016	18-0858	18-2016
V-150 CARB	C239553	& SUP	18-0860	18-2016	18-0858	18-2016
V-150 XR4 / 6 MAG II, III	C239553	& SUP	18-0860	18-2016	18-0858	18-2016
V-150 EFI	D082000	& SUP	18-0860	18-2016	18-0858	18-2016
V-150 DFI	G590000	& SUP	18-0860	18-2016	18-0858	18-2016
V-175 (V-175, 1750) CARB	4301235	5393736	N/D	18-2016	N/D	18-2016
V-175 CARB	5393737	6618750	N/D	18-2016	N/D	18-2016
V-175 CARB	6618751	C239552	18-0860	18-2016	18-0858	18-2016
V-175 CARB	C239553	& SUP	18-0860	18-2016	18-0858	18-2016
V-175 EFI	D000750	& SUP	18-0860	18-2016	18-0858	18-2016
V-175 DFI	T178500	& SUP	18-0860	18-2016	18-0858	18-2016
V-175 PRO XS	B516339	& SUP	18-0860	18-2016	18-0858	18-2016
V-200 (V-200, 2000) CARB	4839034	5363917	25-67207	18-2016	N/D	18-2016
V-200 CARB	5363918	6073191	N/D	18-2016	N/D	18-2016
V-200 CARB	6073192	C291519	18-0860	18-2016	18-0858	18-2016
V-200 CARB	C291520	& SUP	18-0860	18-2016	18-0858	18-2016
V-200 EFI	C100861	C291519	18-0860	18-2016	18-0858	18-2016
V-200 EFI (2.5L)	C291520	& SUP	18-0860	18-2016	18-0858	18-2016
V-200 DFI	G386496	& SUP	18-0860	N/D	18-7414	N/D
V-200 PRO XS	B504989	& SUP	18-0860	N/D	18-7414	N/D
V-200 LASER	B117316	& SUP	18-0860	18-2016	18-0858	18-2016
V-225 (2.4L)	5628028	& SUP	18-0860	18-2016	N/D	18-2016
V-225 (3.0L) SEA PRO / MARATHON CARB	G245605	G303045	18-0860	N/D	18-7414	N/D
V-225 (3.0L) SEA PRO / MARATHON CARB	G303046	& SUP	18-0860	N/D	18-7414	N/D
V-225 DFI	G590000	& SUP	18-0860	N/D	18-7414	N/D
V-225 PRO XS	B104549	& SUP	18-0860	N/D	18-7414	N/D
V-225 EFI	G129222	G303045	18-0860	N/D	18-7414	N/D
V-225 EFI	G303046	& SUP	18-0860	N/D	18-7414	N/D
V-250 w/o Cojinete sup.	C101891	& SUP	N/D	N.L.A.	18-7414	18-2016
V-250 w/Cojinete sup.	C101891	& SUP	N/D	N.L.A.	18-7414	18-2016
V-250 EFI	G129222	G303045	18-0860	N/D	18-7414	N/D
V-250 EFI	G303046	& SUP	18-0860	N/D	18-7414	N/D
V-250 DFI	B528615	& SUP	18-0860	N/D	18-7414	N/D
V-250 PRO XS	B426561	& SUP	18-0860	N/D	18-7414	N/D
V-275 CARB w/o Cojinete sup.	C101891	& UP	N/D	N.L.A.	18-7414	N/D
V-275 CARB w/Cojinete sup.	C101891	& UP	N/D	N.L.A.	18-7414	N/D
V-300 (3.4L)	5611648	& UP	N/D	N.L.A.	18-7414	N/D

① Requiere 2

② Retenedor Eje cambio

④ Se adapta a la mayoría de aplicaciones

APLICACIÓN DE AROS DE UNIDAD INFERIOR

HP	Desde N° Serie.	Hasta N° Serie.	Aro tórico Cojinete	Base bomba de agua	Cambio Eje	Eje Dirección
3.9	1655013	2498135	18-7121	18-7156	18-7180	18-7168
4	2498136	5589201	18-7121	18-7156	18-7180	18-7168
4/4.5	5589203	A809601	18-7171	18-7156	18-7180	-
6	1408611	2529894	18-7171	18-7156	18-7180	18-7168
6	A197112	SUP	18-7162	-	-	-
7.5	2529895	3801457	18-7171	18-7156	18-7180	18-7168
7.5	3801458	5206549	18-7171	18-7156	18-7180	-
7.5	5206550	SUP	18-7171	18-7156	18-7180	18-7116
8	A197112	SUP	18-7162	-	-	-
9.8	1470349	3795657	18-7171	18-7156	18-7180	18-7168
9.8	3795658	5206549	18-7171	18-7156	18-7180	-
9.8	5206550	SUP	18-7171	18-7156	18-7180	18-7116
9.9/15	A197112	SUP	18-7162	-	-	-
18	5837437	6443972	-	18-7419	-	-
20	1558310	1866494	18-7163	18-7164	18-7180	18-7180
20	1866495	6443972	18-7163	18-7164	18-7180	18-7180
25	5705532	6443972	-	18-7419	-	-
18/20/25XD	6443973	SUP	-	18-7419	18-7135 ②	-
30	1271885	1356947	18-7152	18-7115	18-7153	-
30	G055314	SUP	-	-	18-7155 ②	-
MK 35A	1217222	1271884	18-7152	18-7115	18-7153	-
35	1356948	1448139	18-7152	18-7115	18-7153	-
35	1571114	1960826	18-7160	18-7155	18-7153	-
35	1960827	2874703	18-7160	18-7155	18-7153	-
35	6445653	SUP	18-7160	18-7115	18-7153	-
40	1279685	2874703	18-7152	18-7115	18-7153	-
40	2874704	3336257	18-7160	18-7155	18-7153	-
40	3336258	4117709	18-7160	18-7155	18-7153	-
40	4117710	4860102	18-7160	18-7155	18-7153	-
40	4860103	6445652	18-7160	18-7115	18-7153	-
40 4cil	C159200	G053313	18-7160	18-7115	18-7153	-
40 2cil	G055314	SUP	-	-	18-7155 ②	-
45	1476510	1531568	18-7160	18-7155	18-7153	-
45 4cil	5531630	SUP	18-7160	18-7115	18-7153	-
50	1421113	1639472	18-7152	18-7155	18-7153	-
50	1639473	1770178	18-7160	18-7155	18-7153	-
50	1770179	2305100	18-7160	18-7155	18-7153	-
50	2305101	2858813	18-7160	18-7155	18-7153	-
50	2858814	4140999	18-7160	18-7155	18-7153	-
50	4141000	4962055	18-7160	18-7155	18-7153	-
50	4962056	5531630	18-7160	18-7155	18-7153	-
50 3cil	6428681	D000750	18-7160	18-7155	18-7153	-
50/55/60 3 cil	D000751	SUP	-	18-7173	-	-
60	1303411	1542744	-	18-7115	-	-
60	6428681	D000750	18-7160	18-7155	18-7153	-
65	1542745	2874263	18-7157	18-7173	18-7153	18-7158
65	2874263	3293183	18-7157	18-7162	18-7153	18-7158
65 3cil	3293184	4136684	18-7160	18-7155	18-7153	-
65 3cil	4136685	4571651	18-7160	18-7155	18-7153	-
70	1296411	1413610	18-7114	18-7155 ①	-	-
70	1413611	1566239	18-7157	18-7173	18-7153	18-7158
70 3cil	4571652	4977156	18-7160	18-7155	18-7153	-
70 3cil	4977157	5579016	18-7160	18-7115	18-7153	-
70 3cil	5579017	A996142	18-7160	18-7115	18-7153	-
70/75 3cil	A996142	SUP	-	-	18-7198	-
75 4cil	6432901	A996142	18-7157	18-7162	18-7153	-
80	1335465	1398629	18-7157	18-7155	18-7153	18-7158
80	1398630	1566239	18-7157	18-7173	18-7153	18-7158
80 4cil	2559001	3144218	18-7157	18-7173	18-7153	18-7158
80 4cil	3144219	4831998	18-7157	18-7162	18-7153	-
80 4cil	4831999	5582561	18-7157	18-7162	18-7153	-
80 4cil	5582562	A996142	18-7157	18-7162	18-7153	-
80 3cil	A996142	SUP	-	-	18-7198	-
85	1460999	1766823	18-7157	18-7173	18-7153	18-7158
85 4cil	3493913	4590511	18-7157	18-7162	18-7153	-

① Requiere 2

② Retenedor Eje cambio

④ Se adapta a la mayoría de aplicaciones

APLICACIÓN AROS UNIDAD INFERIOR (Cont.)

HP	Desde N° Serie.	Hasta N° Serie.	Aro tórico Cojinete	Base bomba de agua	Cambio Eje	Eje Dirección
85 4cil	4590512	4831998	18-7157	18-7162	18-7153	-
90	1766824	1869775	18-7157	18-7162	18-7153	18-7158
90	4845301	5594656	18-7157	18-7162	18-7153	-
90	5594657	A996142	18-7157	18-7162	18-7153	-
90 3cil	A996142	SUP	-	-	18-7198	-
95	1869776	2318585	18-7157	18-7173	18-7153	18-7158
100,100SS	1464949	2836018	18-7157	18-7173	18-7153	18-7158
100BP	2399698	2641854	18-7157	18-7173	18-7153	18-7158
100 4cil	B209468	-	-	-	18-7198	-
110	1870204	2314955	18-7157	18-7173	18-7153	18-7158
115	2836019	3525440	18-7157	18-7173	18-7153	18-7158
115	3525440	41122634	18-7157	18-7173	18-7153	-
115	41122635	4855152	18-7157	18-7162	18-7153	-
115	4855153	5600966	18-7157	18-7162	18-7153	-
115	5600967	C100000	18-7157	18-7162	18-7153	-
115 4cil	C100000	SUP	-	-	18-7198	-
125	2314956	2839368	18-7157	18-7173	18-7153	18-7158
135	2839369	3293233	18-7157	18-7173	18-7153	18-7158
140	3293234	3502805	18-7157	18-7173	18-7153	-
140	4865678	SUP	18-7157	18-7162	18-7153	-
150	3502806	4121434	18-7157	18-7173	18-7153	-
150	4121434	5327662	18-7157 ④	18-7162	18-7153	-



V-6

150/150XR2	4868998	5432021	18-7159	18-7162	18-7153	-
150/150XRS	5432021	A904646	18-7159	18-7176	18-7153	-
135/150/XR2	A904646	SUP	18-7159	18-7176	18-7153	-
175	4301235	6618750	18-7159	18-7162	18-7153	-
175	6618751	SUP	18-7159	18-7176	18-7153	-
200	4839034	6073191	18-7159	18-7162	18-7153	-
200	6073192	SUP	18-7159	18-7176	18-7153	-
220	B117316	SUP	18-7159	18-7176	18-7153	-
225	5628028	D280813	18-7159	18-7162	18-7153	-
250/275	C101891	SUP	18-7159	-	18-7153	-
3.4	5611648	SUP	18-7159	-	18-7153	-

APLICACIÓN AROS CON ABRAZADERA GIRATORIA

HP	Desde N° Serie.	Hasta N° Serie.	Aros	Cant.	Desc.	HP	Desde N° Serie.	Hasta N° Serie.	Aros	Cant.	Desc.
3.9	1655013	2498135	18-7153	2	SB	V 135	A904646	SUP	18-7164	1	SB
4	2498136	3529445	18-7153	1	SB	V 135	A904646	SUP	18-7174	1	TT
6	1436115	2529894	18-7153	2	SB	V 150	4868998	SUP	18-7164	1	SB
7.5	2529895	3488152	18-7153	2	SB	V 150	5432022	6606990	18-7168	2	TLL
9.9	1470349	3482752	18-7153	2	SB	V 150	6443213	SUP	18-7174	1	TT
35 ①	B110789	C159199	18-7164	1	SB,U	V 175	4301235	SUP	18-7164	1	SB
35 ①	B110789	C159199	18-7174	1	TT	V 175	5488752	6618750	18-7168	2	TLL
45 4 Cil ①	B110789	SUP	18-7174	1	TT	V 175	6618751	SUP	18-7174	1	TT
45 4 Cil ①	B110789	SUP	18-7164	1	SB,U	V 200	4839034	SUP	18-7164	1	SB
50 3 Cil ①	B122930	C160935	18-7164	1	SB,U	V 200	5464486	6625220	18-7168	2	TLL
50 3 Cil ①	B122930	C160935	18-7174	1	TT	V 200	6625221	SUP	18-7174	1	TT
60 3 Cil ①	B122930	C160935	18-7174	1	TT	V 200 EFI	C100861	SUP	18-7174	1	TT
60 3 Cil ①	B122930	C160935	18-7164	1	SB,U	V 200 EFI	C100861	SUP	18-7164	1	SB
70	A996142	SUP	18-7174	2	TT	V 220	B117316	SUP	18-7174	1	TT
70	A996142	SUP	18-7164	1	SB	V 220	B117316	SUP	18-7164	1	SB
75	6432901	SUP	18-7174	2	TT	V 225	5628028	SUP	18-7164	1	SB
75	6432901	SUP	18-7164	1	SB	V 225	5628028	SUP	18-7168	2	TLL
80	A996142	SUP	18-7164	1	SB	V 250	C101891	SUP	18-7168	2	TLL
80	A996142	SUP	18-7174	2	TT	V 250	C101891	SUP	18-7174	1	TT
90	6436123	SUP	18-7164	1	SB	V 275	C101891	SUP	18-7174	1	TT
90	6436123	SUP	18-7174	2	TT	V 275	C101891	SUP	18-7168	2	TLL
100	B209468	SUP	18-7164	1	SB	3.4 LT	5611648	SUP	18-7168	2	TLL
100	B209468	SUP	18-7174	1	TT	3.4 LT	5611648	SUP	18-7174	1	TT
115	6436123	SUP	18-7164	1	SB	3.4 LT	5611648	SUP	18-7164	1	SB
115	6436123	SUP	18-7174	2	TT	XR-4/Magnum II	B242885	SUP	18-7174	1	TT
						XR-4/Magnum II	B242885	SUP	18-7164	1	SB

① Modelos solo con power trim SB Abraz giratoria SB,U Abraz. giratoria sup. TLL Palanca Tilt TT Tubo Tilt

2 TIEMPOS MARINER 				2 TIEMPOS MARINER 			
MARINER	AÑO	Ref. CHAMPION	Ref. PRONAUTIC	MARINER	AÑO	Ref. CHAMPION	Ref. PRONAUTIC
2 TIEMPOS				15HP651		RL82C/L82C	050924/050937
2HP	1993-94	L86CC/L86C	050953/050910	15HP684-669		RL82C/L82C	050924/050937
2.5HP 1 CIL.	1989-97	L86CC/L86C	050953/050910	15HP Marathon	1992+	L92LCC	051020
2.5HP	1998+	QL87YC/L87C	050920/	20HP	1985+	QL78YC/L78YC	050917/050933
3HP	1990-92	L86CC/L86C	050953/050910	20HP 653,6A9		RL86C/L86C	050925/050910
3.3HP	1993-97	L86CC/L86C	050953/050910	20HP Hign-Ing		RA8HC	050957
3.5HP	1993-94	L86CC/L86C	050953/050910	25HP		QL78YC/L78YC	050917/050933
4HP	1990-97	RL82C/L82C	050924/050937	25HP 648,690,695		QL77JC4/L77JC4	050914/050906
5HP 1 CIL.	1990+	RL82C/L82C	050924/050937	25HPMar.25 648	1993-96	QL77JC4/L77JC4	050914/050906
5HP 5B-5C	1990-97	RL82C/L82C	050924/050937	25HP 2C. Mar.25	1993+	QL78YC/L78YC	050917/050933
6HP 6C-6HB	1993-96	RL82C/L82C	050924/050937	28HP 664		RL82C/L82C	050924/050937
6HP 2 CIL.	1992-97	QL78YC/L78YC	050917/050933	30HP 30A 689,A	1992-97	RL82C/L82C	050924/050937
6HP 6B(678)	1993-96	RL82C/L82C	050924/050937	30HP Marathon		QL78YC/L78YC	050917/050933
6HP 6C(6H8)	1993-96	RL82C/L82C	050924/050937	40HP	1989-98	QL78YC/L78YC	050917/050933
6HP	2000+	L92LCC	051020	40HP 4 CIL.	1989-97	QL78V/L78V	050916/050908
8HP K8-8A	1991-95	RL82C/L82C	050924/050937	40HP 6F5-6F6	1992-96	QL78C/L78C	050915/050907
8HP 6 CIL.	1991-95	RL82C/L82C	050924/050937	40HP A-B		QL78C/L78C	050915/050907
8HP B-W8	1991-95	RL82C/L82C	050924/050937	40HP 6E9	1992-96	QL78C/L78C	050915/050907
8HP 2 CIL.	1987-97	QL78YC/L78YC	050917/050933	40HP 676B	1992-96	QL78C/L78C	050915/050907
8HP 2 CIL.	1998+	L92LCC	051020	45HP	1986-89	QL78V/L78V	050916/050908
8HP Marathon	1991-95	RL82C/L82C	050924/050937	48HP		L82CC	051021
9.9HP(682)		RL82C/L82C	050924/050937	50HP	1980-98	QL78V/L78V	050916/050908
9.9HP 2 CIL.	1995-97	QL78YC6/ L78YC6	050962/050923	55HP		QL78C/L78C	050915/050907
9.9HP 2 CIL.	1998+	L92LCC	051020	55HPMar.	1991+	QL78YC/L78YC	050917/050933
9.9HP	1987-94	QL78YC/L78YC	050917/050933	60HP 3 CIL.	1991-98	QL78YC/L78YC	050917/050933
10HP Marathon	1991+	QL78YC6/ L78YC6	050962/050923	60HP 3 CIL.	1984-90	QL76V/L76V	050913/050905
15HP 2 CIL.		L92LCC	051020	60HP 2 CIL.		QL78C/L78C	050915/050907
15HP 2 CIL.	1989-97	QL78YC6/ L78YC6	050962/050923	70HP		QL78V/L78V	050916/050908



2 TIEMPOS MARINER



4 TIEMPOS MARINER



MARINER	AÑO	Ref. CHAMPION	Ref. PRONAUTIC	MARINER	AÑO	Ref. CHAMPION	Ref. PRONAUTIC
75HP		QL78V/L78V	050916/050908	4 TIEMPOS			
85HP		QL78V/L78V	050916/050908	F4	2000-2004	RA8HC	050957
90HP 6 CIL		QL76V/L76V	050913/050905	F5	2000-2004	RA8HC	050957
90HP 4 CIL		QL78V/L78V	050916/050908	F6	2000-2004	RA8HC	050957
90HP3 CIL		QL78V/L78V	050916/050908	F9.9	2000-2004	RA8HC	050957
100HP		QL78YC/L78YC	050917/050933	F9.9 Sail power	1995-2004	Z9Y	051014
105HP	1995-97	QL6VC/L6VC	050912/050934	F15 Big foot	1998-2004	RA8HC	050957
115HP 4 CIL		QL78YC/L78YC	050917/050933	F25 Big foot	1997-2004	RA8HC	050957
115HP 6CIL		QL76V/L76V	050913/050905	F30	1999-2004	RA8HC	050957
125HP	1994+	QL78YC/L78YC	050917/050933	F40 Big foot	1998-2004	RA8HC	050957
135HPV6 Ma.		QL6VC/L6VC	050912/050934	F50 Big foot	1995-2004	RA8HC	050957
135HP V6		QL78YC/L78YC	050917/050933	F60	2001-2004	RA8HC	050957
140HP 6 CIL		QL76V/L76V	050913/050905	F75DOHL	2000-2004	10YC4	050984
150HP V6EFI	1991-97	QL76VC/L76VC	050913/050905	75EFI		14PYC	050984
150HP DFI		R10ECC	051022	80EFI		14PYC	050984
175HP		QL6VC/L6VC	050912/050934	90DOHL	2000-2004	10YC4	050984
200HP		QL6VC/L6VC	050912/050934	90EFI		14PYC	051024
200HP EFI		QL78YC/L78YC	050917/050933	100EFI		14PYC	051024
220HP V6 3.0DFI		R10ECC	051022	115DOHL	2000-2004	10YC4	050984
220HPMagV220		RQL6VC/L6VC	050913	115EFI		14PYC	051024
225HP		QL77CC	050989	OPTIMAX Todos		QC12GMC	051025
250HP 6CIL 3.4L		RQL6VC/L6VC	050913/050934				
250HP V6		QL77CC	050989				
260HP		QL6VC/L6VC	050912/050934				
265HP		QL6VC/L6VC	050912/050934				
275HP		QL6VC/L6VC	050912/050934				

2 TIEMPOS MERCURY 				2 TIEMPOS MERCURY 			
MERCURY	AÑO	Ref. CHAMPION	Ref. PRONAUTIC	MERCURY	AÑO	Ref. CHAMPION	Ref. PRONAUTIC
2 TIEMPOS				15 HP Sea Pro	1995-97	QL78YC6/ L78YC6	050962/050923
2'5HP	1993-04	QL87YC/L87YC	050920/050938	15 HP 2 CIL.	1989-97	QL78YC6/ L78YC6	050962/050923
3 HP	1990-92	RL82YC/L82YC	050952/050909	15 HP 2 CIL.Sea	1998 +	L92LCC	O51020
3'3 HP	1993-97	RL82YC/L82YC	050952/050909	18 HP	1980-85	QL77JC4/L77JC4	050914/050906
3'3 HP	1998 +	RL87YC/L87YC	050963/050938	20 HP 2 CIL.	1998 +	QL78V/L78V	050916/O50908
3'5 HP	1983-85	RL82YC/L82YC	050952/050909	20 HP 2 CIL.	1986-97	QL78YC/L78YC	050917/050933
4 HP	1986-87	RL78V/L78V	000000/050908	25 HP 2 CIL.Sea	1993-97	QL78YC/L78YC	050917/050933
4 HP	1980-82	RL82YC/L82YC	050952/050909	25 HP 2 CIL.	1980-98	QL78YC/L78YC	050917/050933
4 HP	1988-97	RL82YC/L82YC	050952/050909	30 HP 2 CIL.Sea	1995-98	QL78YC/L78YC	050917/050933
4 HP 1 CIL.	1988	QL82YC/L82YC	050918/050909	30 HP 2 CIL.	1995 +	QL78YC/L78YC	050917/050933
4'5 HP	1977-85	QL78V/L78V	050916/050908	35 HP	1984-91	QL76V/L76V	050913/050905
5 HP	1988-97	RL82YC/L82YC	050952/050909	40 HP	1970-83	QL76V/L76V	050913/050905
5 HP 1 CIL.	98 +	RL82YC/L82YC	050952/050909	40 HP	1988-98	QL78YC/L78YC	050917/050933
6 HP 2 CIL.	98 +	L92LCC	O51020	45 HP	1986-89	QL78YC/L78YC	050917/050933
6 HP	1986-97	QL78YC/L78YC	050917/050933	50 HP	1970-90	QL76V/L76V	050913/050905
7'5 HP	1970-78	QL78V/L78V	050916/050908	50 HP 3 CIL.	1991-98	QL78YC/L78YC	050917/050933
7'5 HP	1979-85	QL77JC4/L77JC4	050914/050906	55 HP Sea Pro	1992-98	QL78YC/L78YC	050917/050933
8 HP	1986-97	QL78YC/L78YC	050917/050933	60 HP	1980-84	QL76V/L76V	050913/050905
8 HP	1998 +	L92LCC	O51020	60 HP 3 CIL.	1991-98	QL78YC/L78YC	050917/050933
9'8 HP	1970-78	QL78V/L78V	050916/050908	65 HP	1970-76	QL76V/L76V	050913/050905
9'8 HP	1979-85	QL77JC4/L77JC4	050914/050906	70 HP	1977-83	QL76V/L76V	050913/050905
9'9 HP 2 CIL.	1995-97	L78YC6	O50923	70 HP	1987-89	QL78V/L78V	050916/050908
9'9 HP 2 CIL.	1998	L92LCC	O51020	75 HP	1984-98	QL78V/L78V	050916/050908
9'9 HP	1986-94	QL78YC/L78YC	050917/050933	80 HP	1978-89	QL78V/L78V	050916/050908
10 HP sea Pro	1991-97	QL78YC6/ L78YC6	050962/050923	90 HP 6 CIL.	1978-86	QL76V/L76V	050913/050905
10 HP	1991-96	QL78YC6/ L78YC6	050962/050923	90 HP 3CIL.	1987-98	QL78V/L78V	050916/050908
15 HP 2 CIL.	1998 +	L92LCC	O51020	100 HP	1988-96	QL78YC/L78YC	050917/050933

2 TIEMPOS MERCURY





MERCURY	AÑO	Ref. CHAMPION	Ref. PRONAUTIC
115 HP 6 CIL.	1970-88	QL76V/L76V	050913/050905
115 HP 4 CIL.	1989-98	QL78YC/L78YC	050917/050933
125 HP	1994-98	QL78YC/L78YC	050917/050933
135 HP 6 CIL.	1986-97	QL6VC/L6VC	050912/050934
135 HP V6	2000 +	QL82YC/L82YC	050918/050909
140 HP	1970-80	QL6VC/L6VC	050912/050934
150 HP V6	1978-97	QL6VC/L6VC	050912/050934
150 HP V6 EFI	2000 +	QL82YC/L82YC	050918/050909
150 V6 XR2-4-6	1985-97	QL6VC/L6VC	050912/050934
150 HP V6 XR1	1993-97	QL6VC/L6VC	050912/050934
175 HP V6 Xri	1997-97	QL6VC/L6VC	050912/050934
175 HP V6 XriEFI	2000+	QL82YC/L82YC	050918/050909
200 HP V6	1978-97	QL6VC/L6VC	050912/050934
200 HP V6	2000+	QL82YC/L82YC	050918/050909
200 HP V6 Xri	1989-97	QL6VC/L6VC	050912/050934
200 HP V6 XriEFI	2000+	QL82YC/L82YC	050918/050909
200 HP 2.0LXR 2EFI	1997+	QL76V/L76V	050913/050905
225 HP V6 XRIEFI	1995-97	QL77CC	050989
225 HP V6 3.0L	1995-97	QL78YC/L78YC	050917/050933
225 HP V6 3.0L	1998+	QL77CC	050989
225 HP V6	1994-97	QL78YC/L78YC	050917/050933
225 HP V6	1998+	QL77CC	050989
245 HP 2.5L	1995-96	QL6VC/L6VC	050912/050934
250 HP 3.4L	1989-90	QL6VC/L6VC	050912/050934
250 HP V6 XRIEFI	1995-98	QL77CC	050989
265 HP	1997+	QL6VC/L6VC	050912/050934
275 HP	1984-94	QL6VC/L6VC	050912/050934



280 HP	1997+	QL6VC/L6VC	050912/050934
300 HP 2.5L EFI	1997+	QL6VC/L6VC	050912/050934
300 HP	1980-83	QL76VC/L76VC	051017/051018



4 TIEMPOS MERCURY



MERCURY	AÑO	Ref. CHAMPION	Ref. PRONAUTIC
4 TIEMPOS			
F4	2000-2004	RA8HC	O50957
F5	2000-2004	RA8HC	O50957
F6	2000-2004	RA8HC	O50957
F9.9	2000-2004	RA8HC	O50957
F9.9 Sail Power	1995-2004	Z9Y	O51014
F15 Big Foot	1998-2004	RA8HC	O50957
F25 Big Foot	1997-2004	RA8HC	O50957
F30	1999-2004	RA8HC	O50957
F40 Big Foot	1998-2004	RA8HC	O50957
F50 Big Foot	1995-2004	RA8HC	O50957
F60	2001-2004	RA8HC	O50957
F75DOHL	2000-2004	REC10YC4	O51016
75 EFI		REC14PYC	O51024
80 EFI		REC14PYC	O51024
90 DOHL	2000-2004	REC10YC4	O51016
90 EFI		REC14PYC	O51024
100 EFI		REC14PYC	O51024
115 DOHL	2000-2004	REC10YC4	O51016
115 EFI		REC14PYC	O51024
OPTIMAX todos		QC12GMC	O51025

MERCURY / MARINER 				MERCURY / MARINER 			
POTENCIA HP	AÑO	Ref. NGK	Ref. PRONAUTIC	POTENCIA HP	AÑO	Ref. NGK	Ref. PRONAUTIC
2,2	1989-1984	BPR6HS-10	050741	10, 2T Sea Pro	2001	BPZ8HS-15	050863
2,5	2001-1993	BPR6HS	050827	10, 2T Sea Pro	2000-1991	BP8HS-15	050869
3	1992-1990	B6HS	050804	10 XR10	1998-1992	BP8HS-15	050869
3,3	2001-1993	BPR6HS	050827	15, 2T	2000-1989	BP8HS-15	050869
3,5	1985-1983	BP6HS-10	050820	15, 2T	2001	BPZ8HS-15	050863
3,6	1982-1980	BP7HS-W	050822	15, 4T	2003-1998	DPR6EA-9	050865
4.0, 2T	2001-1988	BPR7HS	050829	15, 2T 15 Sea Pro	2001	BPZ8HS-15	050863
4.0, 4T	2003-2000	DCPR7E	050894	15, 2T 15 Sea Pro	2000-1997	BP8HS-15	050869
4.0.	1982-1980	BP7HS	050822	15, 15 Sea Pro	1996-1995	BP8HS-10	050729
4.0, 40 Gnat	1979-1976	BR6HS	050714	18	1983-1981	BP8H-N-10	050871
4,5	1985-1975	BUHW-2	050840	18 XD	1985-1984	BP8H-N-10	050871
5.0, 2T	2001-1988	BPR7HS	050829	20, 2T 20	2000-1986	BP8H-N-10	050871
5.0, 4T	2003-2001	DCPR7E	050894	20, 2T 20	2001	BPZ8H-N-10	050870
6.0, 2T	2001	BPZ8H-N-10	050870	20	1980-1979	BUHW-2	050840
6.0, 2T	2000-1986	BP8HN-10	050871	20, 2T 25	2001	BPZ8H-N-10	050870
6.0, 4T	2003-2000	DCPR7E	050894	20, 200	1978-1970	BUHW-2	050840
7,5	1985-1979	B9HS-10	050813	20, 2T 20 Jet	2000-1995	BP8H-N-10	050871
7,5	1978-1975	BUHW-2	050840	20, 2T 20 Jet	2001	BPZ8H-N-10	050870
8.0, 2T	2001	BPZ8H-N-10	050870	20, 2T 25 Sea Pro	2001	BPZ8H-N-10	050870
8.0, 2T	2000-1986	BP8HN-10	050871	25, 2T	2000-1993	BP8H-N-10	050871
8.0 Bondensee	1999-1995	CR6HS	050845	25, 4T	2003-1998	DPR6EA-9	050865
9,8	1985-1979	B9HS-10	050813	25	1992-1986	BP8H-N-10	050871
9.8, 110	1978-1975	BUHW-2	050840	25	1983-1990	BP8H-N-10	050871
9.9, 2T	2001	BPZ8HS-15	050863	25, 2T 25 Sea Pro	2000-1993	BP8H-N-10	050871
9.9, 2T	2000-1995	BP8HS-15	050869	25 XD	1986-1984	BP8H-N-10	050871
9.9, 4T	1998-1995	CR6HS	050845	30, 2 CIL, 2T	2001	BPZ8H-N-10	050870
9.9, 4T	1994-1986	BP8H-N-10	050871	30, 2 CIL, 2T	2000-1995	BP8H-N-10	050871
9.9, 4T	2003-1999	DPR6EA-9	050865	30, 2 CIL, 4T	2003-1999	DPR6EA-9	050865
10	1991	BP8HS-15	050869				

MERCURY / MARINER 				MERCURY / MARINER 			
POTENCIA HP	AÑO	Ref. NGK	Ref. PRONAUTIC	POTENCIA HP	AÑO	Ref. NGK	Ref. PRONAUTIC
30, 3 CIL	1997-1995	BUHW-2	050840	55, 3 CIL., 2T 55 Sea Pro	2001	BPZ8H-N-10	050870
30, 3 CIL, 2T	2001	BPZ8H-N-10	050870	55, 3 CIL., 2T 55 Sea Pro	2000-1992	BP8H-N-10	050871
30, 2CIL, 2T, 30 Jet	2001	BPZ8H-N-10	050870	60, 3 CIL., 2T	2001	BPZ8H-N-10	050870
30, 3CIL, 2T, 30 Jet	2000-1998	BP8H-N-10	050871	60, 3 CIL., 2T	2000-1991	BP8H-N-10	050871
30, 2CIL, 2T, 30 Sea Pro	2001	BPZ8H-N-10	050870	60, 4 CIL., 4T	2003-2001	DPR6EA-9	050865
30, 2CIL, 2T, 30 Sea Pro	2000-1995	BP8H-N-10	050871	60	1990-1984	BUHW	050839
35	1991-1984	BUHW-2	050840	60 Big Foot	1997-1995	BP8H-N-10	050871
40, 2 CIL., 2T	2001	BPZ8H-N-10	050870	60, 3 CIL., 2T Sea Pro	2001	BPZ8H-N-10	050870
40, 2 CIL., 2T	2000-1995	BP8H-N-10	050871	60, 3 CIL., 2T Sea Pro	2000-1995	BP8H-N-10	050871
40, 3 CIL., 2T	2001	BPZ8H-N-10	050870	65, 3 CIL., 2T Jet	2001	BUZHW-2	050703
40, 3 CIL., 2T	2000-1998	BP8H-N-10	050871	65, 3 CIL., 2T Jet	2000-1995	BUZHW-2	050703
40, 3 CIL., 4T	2003-1998	DCPR7E	050894	65, 650	1976-1972	BUHW	050839
40, 4 CIL.	1997-1988	BUHW-2	050840	70	1989-1987	BUHW-2	050840
40, 400	1971-1970	BUHW	050839	70	1983-1979	BUHW	050839
40, 402	1978-1972	BUHW	050839	70, 700	1978-1977	BUHW	050839
40, 4 CIL., 4T, Big Foot	2003-2001	DPR6EA-9	050865	75, 3 CIL., 2T	2001	BUZHW-2	050703
40, 4 CIL., 2T, Sea Pro	2001	BPZ8H-N-10	050870	75, 3 CIL., 2T	2000-1987	BUHW-2	050840
40, 4 CIL., 2T, Sea Pro	2000-1995	BP8H-N-10	050871	75, 4 CIL., 4T DOHC 75	2003-2000	LF5A-11	050862
45	1989-1986	BUHW-2	050840	75, 3 CIL., 2T Jet	2001	BUZHW-2	050703
45, 4 CIL., 4T, Bordensee	2001-1995	DPR6EA-9	050865	75, 3 CIL., 2T Sea Pro	2000-1991	BUHW-2	050840
45, 3 CIL., 2T Jet	2001	BPZ8H-N-10	050870	75, 4 CIL., 75XD	1986-1984	BUHW-2	050840
45, 3 CIL., 2T Jet	2000-1995	BP8H-N-10	050871	80, 3 CIL.	1989-1987	BUHW-2	050840
50, 3 CIL.	1990-1986	BUHW	050839	80, 4 CIL.	1983-1979	BUHW-2	050840
50, 3 CIL. 2T	2001	BPZ8H-N-10	050870	80, 800	1978	BUHW-2	050840
50, 3 CIL. 2T	2000-1991	BP8H-N-10	050871	80, 4 CIL., 2T 80 Jet	2001	BPZ8H-N-10	050870
50, 4 CIL.	1985-1979	BUHW-2	050840	80, 4 CIL., 2T 80 Jet	2000-1995	BP8H-N-10	050871
50, 4 CIL. 4T	2003-1995	DPR6EA-9	050865	85	1977-1973	BUHW	050839
50, 500	1977-1968	BUHW	050839	90, 3 CIL., 2T	2001	BUZHW-2	050703
50, 500	1978	BUHW-2	050840	90, 4 CIL., 4 T DOHC	2003-2000	LF5A-11	050862

MERCURY / MARINER 				MERCURY / MARINER 			
POTENCIA HP	AÑO	Ref. NGK	Ref. PRONAUTIC	POTENCIA HP	AÑO	Ref. NGK	Ref. PRONAUTIC
90, 6 CIL.	1986-1979	BUHW	050839	150, 6 CIL., 2T Optimax DFI	2002-1998	PZFR5F-11	050846
90	2000-1987	BUHW-2	050840	150XR-2	1987-1985	BU8H	050838
90, 900	1978	BUHW	050839	150XR-4	1991-1988	BU8H	050838
100	1999-1988	BP8H-N-10	050871	150XR-6	1997-1992	BU8H	050838
105 Jet	1998-1995	BU8H	050838	150XRi	1997-1993	BU8H	050838
115, 4 CIL., 2T	2001	BPZ8H-N-10	050870	150, 1500	1977-1973	BUHW	050839
115, 4 CIL., 2T	2000-1989	BP8H-N-10	050871	150, 6 CIL. 4T EFI	2006	ILFR6G	050722
115, 6 CIL.	1988-1979	BUHW	050839	175	1998-1979	BU8H	050838
115, 4 CIL., 4T, EFI MFI	2003-2001	LFR5A-11	050862	175, 1750	1978-1976	BUHW	050839
115, 6 CIL., 2T Optimax	2000	PZFR5F-11	050846	175 EFI	1999-1998	BU8H	050838
115	1978-1970	BUHW	050839	175, 6 CIL. 2T EFI MFI	2001-2000	BPZ8HS-10	050842
125, 4 CIL. 2T	2001	BPZ8H-N-10	050870	175, 6 CIL. 2T Optimax DFI	2002-2001	PZFR5F-11	050846
125, 4 CIL. 2T	2000-1994	BP8H-N-10	050871	175 XRI	1997-1991	BU8H	050838
135, 6 CIL, 2T	2000	BPZ8HS-N-10	050870	175, 6 CIL. 4T EFI	2006	ILFR6G	050722
135	1999-1986	BU8H	050838	200, 6 CIL., 2T	2001-2000	BPZ8HS-10	050842
135, 6 CIL, 4T EFI	2006	ILFR6G	050722	200	1999-1979	BU8H	050838
135, 6 CIL, 2T Optimax DFI	2003	IZFR5G	050876	200, 6 CIL., 4T EFI	2006	ILFR6G	050722
135, 6 CIL, 2T Optimax DFI	2002-1998	PZFR5F-11	050846	200, 2.0L Duece High EFI	1997	BUZ8H	050735
140, 140	1980-1979	BUHW	050839	200, VERADO, 4T EFI	2004	ILFR6G	050722
140, 1400	1978-1972	BUHW	050839	200, 2.0L F1 EFI	1997	BUZHW	050736
140 Jet	1999-1995	BU8H	050838	200, 2.0L SST 120 EFI	1997	BUHW	050839
150	2000	BPZ8HS-N-10	050870	200, 2.0L XR2SS EFI	1997	BUHW	050839
150	1999-1991	BU8H	050838	200 DFI	1997	PZFR6H	050886
150, 150	1994-1979	BU8H	050838	200 EFI	1999-1998	BU8H	050838
150, 1500	1978	BU8H	050838	200, 6 CIL., 2T 200 EFI MFI	2001-2000	BPZ8HS-10	050842
150, 6 CIL., 2T EFI	2001-2000	BPZ8HS-N-10	050870	200, 6 CIL., 2T 200 Optimax	2003	IZFR5G	050876
150 EFI	1999-1998	BU8H	050838	200, 6 CIL., 2T 200 Optimax	2002-1998	ZFR5F-11	050846
150 Marathon	1988-1985	BU8H	050838	1200 Xri	1997-1989	BUZ8H	050735
150, 6 CIL., 2T Optimax DFI	2003	IZFR5G	050876	200, 2000	1978	BUHW	050839

MERCURY / MARINER

POTENCIA HP	AÑO	Ref. NGK	Ref. PRONAUTIC
220, V-220 Laser	1988-1987	BUZ8H	050735
225, 6 CIL., 2T	2001-1998	BR8HS	050854
225, VERADO, 4T EFI	2004	ILFR6G	050722
225	1997-1994	BPZ8H-N-10	050870
225, 4T EFI	2006	ILFR6G	050722
225	1981-1980	BU8H	050838
225, 6 CIL., 2T EFI DFI	2001-1995	BR8HS	050854
225 Xri EFI	1999-1995	BR8HS	050854
225, 6 CIL., 2T 3.0L Sea Pro	2001-1997	BR8HS	050854
225, 3.0L Work	1997-1994	BPZ8H-N-10	050870
225, 3.0L Work	1998	BR8HS	050854
245, 2.5L	1996-1995	BU8H	050838
250, 4T EFI	2006	ILFR6G	050722
250, 3.4L	1990-1989	BU8H	050838
225, VERADO, 4T EFI	2004	ILFR6G	050722
250, 6 CIL., 2T XRI EFI	2001-1995	BR8HS	050854
260, 2.5L Off-shore	1997-1995	BU8H	050838
265, 2.5L SS Drag EFI	1997	BU8H	050838
275, 4T EFI	2006	ILFR6G	050722
275	1994-1989	BU8H	050838
275, VERADO, 4 T EFI	2004	ILFR6G	050722
300	1983-1981	BU8H	050838
300, 2.5L, S3000 EFI	1997	BU8H	050838
300, 3.0L	2001	BU8H	050838
300, 3.4L	1998-1984	BU8H	050838



18-5225
KIT CABLE BUJÍAS
El kit incluye 7,5 mts de cable de encendido de hypalon de 7mm y un surtido de 3 terminales diferentes para fueraborda..



18-5226
CABLE ENCENDIDO
Alma metálica
Bobina 100'
7mm Hypalon

Pack. de 10



18-5224
18-5224-9①
CABLE TERMINAL ENCENDIDO

Pack. de 10



18-5750
18-5750-9①
TAPA BUJÍAS UNIVERSAL
Suministrado completo con conector terminal



18-5752
TAPA BUJÍAS UNIVERSAL
8mm



18-5133
BOBINA ENCENDIDO
Reemplaza: 3A0-06040-1,
3A0-06048-1
Para: 2002 y Prior M y NS Modelo 25C2,
C3, 30A3, A4; 2003 25C3, A4; 2005 25C3



18-5134
CDI
Reemplaza: 3G2-06060-2
Para: 2002 y Prior M y NS Modelo 15D2,
18E, E2, 9.9D, D2; 2003 15D2, 18E2, 9.9D2



18-5143
BOBINA
Reemplaza: Tohatsu 369-06021-0
Para: 4C, 5B, 5BS (2003)



18-5165
BOBINA
Reemplaza: Nissan 3G3-06021-1
Para: 9.9D(2002 e inferior)9.9D2(2003 e inferior), 15D(2002 e inferior), 15D2(2003 e inferior), 18E(2002 e inferior), 18E2(2003 e inferior)



18-5166
BOBINA ENCENDIDO
Reemplaza:
Nissan/Tohatsu 3G2-06040-2 ss
to 3M3-06048-2
Para: 9.9D(2002 e inferior)9.9D2(2003 e inferior), 15D(2002 e inferior), 15D2(2003 e inferior), 18E(2002 e inferior),18E2(2003 e inferior)



18-5182
BOBINA ENCENDIDO
Reemplaza: Tohatsu 3F0-06153-0
Para: 2.5/3/3.3 HP



18-5185
BOBINA ENCENDIDO
Reemplaza: Tohatsu 3F0-06153-1
Para: 3.5/4.5HP (1997-2005)



18-23207
BOBINA ENCENDIDO
Reemplaza: Tohatsu 3V1060400M
Para: Tohatsu F8/9.8 (2003 & sup)

NISSAN/TOHATSU APLICACIÓN ENCENDIDO

Modelo	Año inicio	Año final	Bobina encendido	CDI	Bobina
FS8	2003	2014	18-23207	-	-
M15	1997	2002	-	18-5134	18-5165
M15	2003	2003	18-5166	18-5134	18-5165
M18	1997	2003	18-5166	18-5134	18-5165
M2.5	1997	2005	18-5182	-	-
M25	1997	2005	18-5133	-	-
M3.5	1997	2005	18-5182	-	-
M30	1997	2003	18-5133	-	-
M4	2003	2003	-	-	18-5143
M5	2003	2003	-	-	18-5143
M9.9	1997	2003	18-5166	18-5134	18-5165
MFS8	2006	2014	18-23207	-	-
MFS8	2003	2004	18-23207	-	-
MFS9.8	2003	2014	18-23207	-	-
NS2.5	1997	2005	18-5185	-	-
NS3.5	1997	2005	18-5185	-	-
NS15	1997	2002	-	18-5134	-
NS18	1997	2002	-	18-5134	-
NS9.9	1997	2002	-	18-5134	-
NSF8	2004	2004	18-23207	-	-
NSF8	2010	2014	18-23207	-	-
NSF9.8	2005	2005	18-23207	-	-
NSF9.8	2010	2014	18-23207	-	-



18-6865
TRIMA COMPLETO
Reemplaza: Tohatsu Universal



18-6823
CABLEADO
Reemplaza: Universal
Convierte motores tilt/trim de 3 a 2 cables.



18-6418
MOTOR ARRANQUE
Reemplaza: Tohatsu 353-76010-4
Para: M45A2, M50C, M60A, M70A2, M90A, M140A, NS45A2, NS50C, NS60A, NS70A2, NS90A, NSD90A, NS120A, NS140A (9 dientes)



18-6430
MOTOR ARRANQUE
Reemplaza: Tohatsu B29A-90500A
Para: 1981-on 2WT60A



18-6431
MOTOR ARRANQUE
Reemplaza: Tohatsu 346-76010-0A0
Para: 2cil 40C, 50C & 50A, 70A, NS25C, NS30A, NS35C, NS40C



18-6432
MOTOR ARRANQUE
Reemplaza: Tohatsu 3C8-76010-1
Para: M50D, M60B, M60C, MD40D, MD50A MFS25A, MFS30A, NS40D, NS50D, NS60C, NS70B, NS70C, NSD25A, NSD30A, NSD50A



18-6448
KIT CONVERSIÓN ELÉCTRICA
 Para: Tohatsu 25 & 30 HP



18-56001
ACOPLAMIENTO ESCOBILLA
 Para: 90-140 HP 2 tiempos
 Usar con motor de arranque 18-6418



18-56002
ACOPLAMIENTO ESCOBILLA
 Reemplaza: 3C8-75014-0
 Para: 25-70 HP 2 tiempos
 Usar con motor de arranque 18-6432



18-7712
FILTRO COMBUSTIBLE (EN LINEA)
 Reemplaza: 369022300M
 Para: 2 tiempos, 5 HP hasta 9.8 HP/4 tiempos, 4 HP hasta 30 HP



FILTRO COMB.

18-7828-1
 (1/4" Pequeño) Capacidad pequeña
 (Para línea combustible 1/4")

18-7829
 (1/4" Grande) Capacidad grande
 (Para línea combustible 1/4")

18-7830 (5/16")
18-7831 (3/8")



18-34500
CARBURADOR
 Reemplaza: 3FS-03100-0, 3V2-03100-0
 Para: 9.9 (4-tiempos)(R042475-R068397)

SEPARADORES AGUA/COMBUSTIBLE



Sierra ofrece una amplia gama de filtros separadores de agua de 10 y 21 micras incluyendo la cazoleta de drenaje para proteger tu carburador y la inyección.

Los filtros separadores de agua eliminan cerca del 98,8% del agua emulsionada de la gasolina. Los filtros Sierra de 10 micras tienen una eficiencia de cerca del 90% eliminando pequeñas partículas tan pequeñas como 10 micras. Todos los filtros tienen un caudal de 90 GPH. Los filtros Sierra de 10 micras son ideales para prevenir posibles daños en intrabordas sensibles y fueraborda de inyección.





CUSTOMER SATISFACTION WARRANTY

**GENUINE PARTS.
AN INDUSTRY-LEADING WARRANTY.**

WE ARE DEDICATED TO PROTECTING YOU AND YOUR INVESTMENT. THERE ARE NO SURPRISES WITH THE SIERRA WARRANTY. WE BELIEVE YOUR BOAT SHOULD ALWAYS BE RUNNING.

WE'VE GOT YOU COVERED!



18-8002EP-1
18-8002EP-1-10②
BOMBA COMBUSTIBLE
1/4"



18-8004EP-1
18-8004EP-1-10②
BOMBA COMB.
5/16"
Entrada grande depósito

18-8005EP-1
18-8005EP-1-10②
BOMBA COMB.
3/8"
Entrada grande depósito



18-8078
CONECTOR DEPÓSITO
1/4" N.P.T. .508 O.D.
Entrada grande depósito Nissan
Para: Todos modelos
Acoplable 18-8079
(Macho)



18-80410
CONECTOR COMBUSTIBLE
Reemplaza: 394-70250-0
5/16"
(Hembra)
Para: 4HP-30HP 4-tiempos
Acoplable 18-80417



18-80417
CONECTOR COMBUSTIBLE
Reemplaza: 394-70260-0
Para: 4HP-30HP 4-tiempos
Acoplable 18-80410



18-8079
CONECTOR COMBUSTIBLE
(Depósito)
Reemplaza: 3B2-70281-0, 65750-95500
Para: Todos los modelos
Acoplable 18-8078
Hembra para manguera de 3/8"



18-8088
CONECTOR COMBUSTIBLE
(Terminal combustible)
Reemplaza: 345-70250-0
3/8" manguera
Para: 5-90HP 2-tiempos y TLDI modelos
Acoplable 18-8089



18-8089
CONECTOR COMBUSTIBLE
(Terminal motor)
Reemplaza: 3B2-70260-0
(Rosca métrica)
5/16" manguera
Para: 5-90HP 2-tiempos y TLDI modelos
Acoplable 18-8088



Pack. de 10



ABRAZADERAS
18-8020 **18-8021**
18-8020-9① **18-8021-9①**
#8 para mang. 5/16" #10 para mang. 3/8"



18-7290
KIT CARBURADOR
Reemplaza: 345-87122-0
Kit contiene componentes para la reparación de 2 carburantes
Para: Todos 35/40C HP (1 por motor)



18-7291
KIT CARBURADOR
Reemplaza: 346-87122-0
Para: Todos 25/30 HP (1 por motor);
Todos 45A2, 50C, 60C, 70A2 (2 por motor)



18-7765
KIT CARBURADOR
Reemplaza: 369-87122-1
Para: Todos 4/5 HP (1 por motor)



18-8920
IMPULSOR
Reemplaza: 3B2-65021-1
Para: 8 (8B modelos), 9.8 (9.8B modelo), 8 4-tiempos (Todos), 9.8 4-tiempos (Todos)



18-8921
IMPULSOR
Reemplaza: 334-65021-0
Para: 9.9 (Todos), 15 (Todos), 18 (Todos), 9.9 4-tiempos (Todos B Modelos), 15 4-tiempos (Todos B Modelos), 18 4-Tiempos (Todos)



18-8922
IMPULSOR
Reemplaza: 3C8-65021-2
Para: 40 3-cil (D modelos), 40 TLDI 2-tiempos(Todos) 50 3-cil (D modelos), 50 TLDI 2-tiempos (Todos), 70 TLDI 2-tiempos(Todos), 90 TLDI 2-tiempos



18-8923
IMPULSOR
Reemplaza: 345-65021-0
Para: 25 (25C modelo), 25 4-tiempos (Todos A Modelos, B Modelos con cojinete blanco), 30 (30A modelo), 30 4-tiempos (Todos A Modelos, B modelos con cojinete blanco), 40 2-cil (40C modelo)



18-8924
IMPULSOR
Reemplaza:
3C7-65021-1, 3B7-65021-2
Para: 60 3-cil (B & C modelos), 70 3-cil (B & C modelos), MD 70, MD 90(TLDI), 115, 140, 90 2-tiempos



18-45404
IMPULSOR
Reemplaza: 353650210M
Para: Nissan/Tohatsu NS50C, NS60A, NS70A2(2002 & Sup)



18-43175
KIT TERMOSTATO
Reemplaza: 3R3-01030-0
Para: Nissan/Tohatsu 9.9-30 HP 4-tiempos



18-43212
BOMBA AGUA ALOJAMIENTO
 Reemplaza: 3B2-65016-0
 Para: 8/9.9 4-tiempos(209cc)

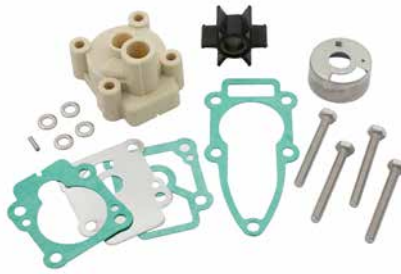

18-48317
KIT BOMBA DE AGUA COMPLETO
 Reemplaza: 3B2-87322-0
 Para: F8/9.8



18-7911-1
FILTRO ACEITE
 Reemplaza: 3R0-07615-0
 Para: 9.9-30HP

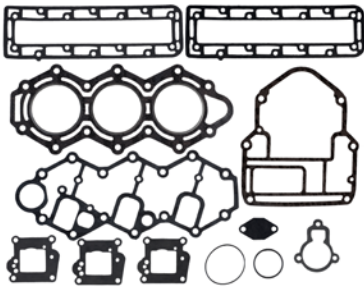

18-4434
JUEGO JUNTAS CULATA
 Reemplaza: 3B2-87321-0
 Para: Todos 40-50 HP

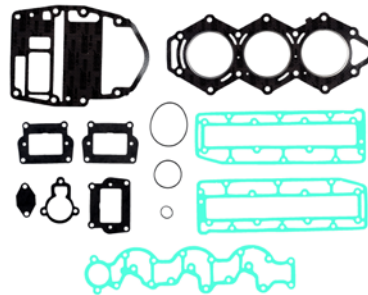

18-4435
JUEGO JUNTAS CULATA
 Reemplaza: 3F3-87121
 Para: Todos 60-70 HP

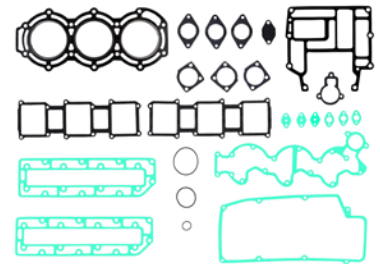

18-4436
JUEGO JUNTAS CULATA
 Reemplaza: 3B7-87121-1 ss -7
 Para: Todos 90 HP



18-64221
JUEGO JUNTAS CULATA
 Reemplaza: 3V1-87121-0
 Para: Mercury 8/9.9(R042475 & Sup)



18-74805
KIT SELLADO UNIDAD INFERIOR
 Reemplaza: 3B2-87321-0
 Para: Nissan/Tohatsu F8/F9.9

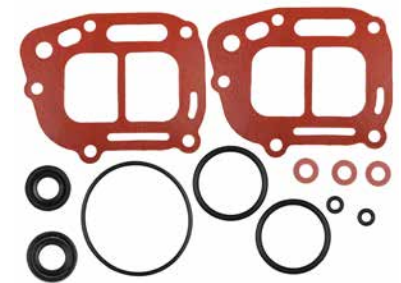

18-74610
KIT SELLADO UNIDAD INFERIOR
 Reemplaza: 398-87321-0
 Para: 18 & 15 (1997-08); 9.9 (1997-04)

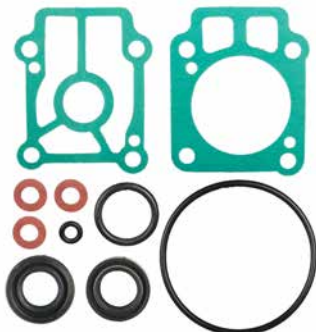

18-74611
KIT SELLADO UNIDAD INFERIOR
 Reemplaza: 346-87321-6
 Para: 25 (1997-05); 30 (1997-03)



18-3850
JUNTA CULATA
 Reemplaza: 3C8-01005-4 ss to -5
 Para: Todos 40-50 HP

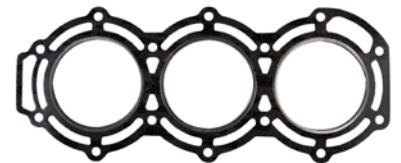

18-3886
JUNTA CULATA
 Reemplaza: 3T9-01005-0
 Para: Todos 90 HP



18-4299
JUNTA CULATA
Reemplaza: 3F3-01005-0 ss to -01
Para: Todos 60-70 HP



18-51000
MUELLE ARRANQUE DE RETR.
Reemplaza: 3AA-05004-0
Para: Tohatsu 8 4-tiempos(2004-12), 9.8 4-tiempos(2004-12)

TAPÓN DE VACIADO JUNTAS



18-60103
Reemplaza: 332600060M
Para: Todos Nissan/Tohatsu modelos



18-60103-50
Para: Todos Nissan/Tohatsu modelos



18-60915
JUNTA CARBURADOR
Reemplaza: 3V1-02011-0
Para: F8/9.8



18-60916
CILINDRO JUNTA CULATA
Reemplaza: 3V1-01005-0
Para: F8/9.8



18-60917
JUNTA TAPA CILINDRO
Reemplaza: 3V1-01024-0
Para: F8/9.8



18-60918
JUNTA DE LA BASE MOTOR
Reemplaza: 3V1-01303-0
Para: F8/9.8



18-60919
JUNTA TAPA ESCAPE
Reemplaza: 3V1-02305-0
Para: F8/9.8



18-60920
JUNTA TERMOSTATO
Reemplaza: 346-01032-0
Para: F8/9.8



18-2448
LLENADO UNIDAD INF./ KIT DE DRENAJE
M8 - 1.25 dientes
Para: Yamaha, Nissan/Tohatsu, & Honda unidades inferiores



18-72656
TAPÓN DE DRENAJE Y JUNTA
Reemplaza: Nissan-Tohatsu 332600051M, 332600060M
M8 - 1.25 dientes
Para: Nissan/Tohatsu - Todos los modelos



18-73964
KIT DE TUERCAS
Para: Nissan/Tohatsu F8/9.8



18-73890
ARANDELA DE EMPUJE
Reemplaza: 3B2-64230-0, 3B2-64230-1
Para: Nissan/Tohatsu F8/9.8



18-79989
ARRASTRE STICKS
Para: mayoría de fuera bordas 150HP con tilt/trim integral.



18-76695
ARO TÓRICO
Reemplaza: Nissan-Tohatsu 3R0-07422-0
Para: 8/9.9 s/n 0r042475 y Sup



TOHATSU



POTENCIA HP	CHAMPION	Ref. PRONAUTIC	POTENCIA HP	NGK	Ref. PRONAUTIC
MODELOS 2T			MODELOS 2T		
3.5HP M3.5A, M3.5B	L87YCC	050985	2.5 HP M2.5A 75cc	BPR6HS	050827
5HP M5B, M5BS	L82YC	050909	3.5 HP M3.5A/M3.5B 75cc	BPR6HS	050827
6HP M6B	L82YC	050909	4 HP M4C	BPR7HS	050829
8HP M8A, M8B 2Cil.	L82YC	050909	5 HP B13B, B9B	BR6HS	050714
9.9HP M9.9B2, M9.9C 2Cil.	L82C	050937	5 HP M5B, M5BS	BPR7HS-10	050843
9.8-12HP B18C, B18D	L86C	050910	6 HP M6B	BPR7HS	050829
12HP M12B	L82C	050937	8 HP M8A, M8B 169cc	BPR5HS	050874
15HP M15A,M15B2,M15C,M15D	L82C	050937	8 HP Proof 8 BEF, 169cc	BPR7HS	050829
16HP M16	L82C	050937	8 HP B13B, B9B	BPR6HS	050827
18HP M18A,M18C2,M18D,M18E	L82C	050937	9.8 HP B18C, B18D	BPR6HS	050827
20HP M20	L82C	050937	9.9 HP M9.9B2/M9.9C	BPR7HS	050829
20-25HP B40A, B30C	L86C	050910	12 HP M12B	BPR7HS-10	050843
25HP M25C, M25C2 2Cil.	L82C	050937	12 HP B18C, B18D	BPR6HS	050827
30HP M30A, M30A3 2Cil.	L82C	050937	13 HP M13	BPR7HS-10	050843
35HP M35A	L82YC	050909	15 HP M15A/M15B2/M15C/ M15D	BPR7HS-10	050843
40HP M40C 2Cil., M40D 3Cil.	L82YC	050909	16 HP M16	BPR7HS-10	050843
50HP M50C, M50D 3Cil.	L78C	050907	18 HP M18A/M18C2/M18D/ M18E 294cc	BPR7HS-10	050843
70HP M70A,M70A2,M70B	L78C	050907	20 HP M20	BPR7HS-10	050843
90HP M90A 3Cil.	L78C	050907	20 HP B40A, B30C	BPR7HS-10	050843
115HP M115A 4Cil.	L78C	050907	25 HP Proof 25C2 430cc	BPR7HS-10	050843
140HP M140A 4Cil.	L78C	050907	25 HP M25C, M25C2	BPR7HS-10	050843
MODELOS 4T			25 HP B40A, B30C	BPR7HS-10	050843
4 HP MFS4, OHV	RA8HC	050957	30 HP M30A/M30A3 400cc	BPR7HS-10	050843
5 HP MFS5A, OHV	RA8HC	050957	35 HP M35A	BPR7HS	050829
5 HP MFS5C, OHV	RA8HC	050957	40 HP MD40B TLDI	PZFR6H	050886
9.9 HP MFS9.9A, OHV	RA8HC	050957	40 HP M40D2 697cc	BPR7HS	050829
15 HP MFS15A, OHV	RA8HC	050957	40 HP Proof 40D Mega 697cc	B8HS-10	050810
			40 HP Proof 40D Mega 697cc EFTO	B8HS-10	050810
			40 HP M40D Mega EPTO 697cc	BR7HS	005053
			40 HP M40C 493cc	BPR6HS-10	050827
			40 HP MD40A TLDI	ZFR6F-11	050723
			50 HP 697cc	B8HS-10	050810
			50 HP MD50A TLDI	ZFR6F-11	050723
			50 HP MD50B TLDI	PZFR6H	050886



TOHATSU



POTENCIA HP	CHAMPION	Ref. PRONAUTIC	POTENCIA HP	NGK	Ref. PRONAUTIC
			50 HP W50	PZFR6H	050886
			50 HP M50C/M50D	B8HS-10	050810
			55 HP M55A/B	B8HS-10	050810
			60 HP 938cc M60A/M60B/ M60C	B8HS-10	050810
			70 HP MD70A 2 TLDI	ZFR6F-11	050723
			70 HP MD70B TLDI	IZFR5J	050724
			70 HP 938cc M70A/M70A2/	B8HS-10	050810
			80 HP M80A	B8HS-10	050810
			90 HP 1267cc M90A	B8HS-10	050810
			90 HP MD90B TLDI	IZFR5J	050724
			90 HP MD90A TLDI	ZFR6F-11	050723
			90 HP MD90A 2 TLDI	ZFR6F-11	050723
			115 HP MD115A TLDI	IZFR5J	050724
			115 HP M115A/A2	B8HS-10	050810
			120 HP 1768cc M120A	B8HS-10	050810
			140 HP 1768cc M140A	B8HS-10	050810
			MODELOS 4T		
			2.5 MFS 2.5A	DCPR6E	050859
			3.5 MFS 3.5A	DCPR6E	050859
			4 MFS 4A	DCPR6E	050859
			5 MFS 5A	DCPR6E	050859
			6 MFS 6A	DCPR6E	050859
			8 MFS 8A	DCPR6E	050859
			9.8 MFS 9.8A	DCPR6E	050859
			9.9 MFS 9.9A/B	DCPR6E	050859
			15 MFS 15A/B/B2	DCPR6E	050859
			18 MFS 18B4/18B	DCPR6E	050859
			25 MFS 25A	DCPR6E	050859
			30 MFS 30A	DCPR6E	050859

Identificación de modelo

Descripción modelo	HP	Modelo de variación de Longitud	Año del Eje	Modelo
DT = 2-ciclos DF = 4-ciclos PU = Jet Drive	Ejemplos: 9.9 40 115 250	E - Arranque eléctrico mando popa R - Arranque eléctrico control remoto C - Inyección aceite G - Contra rotación N - Hélice alto empuje T - Power Tilt & Trim con arranque eléct. y control remoto H - Power Tilt & Trim con arranque eléct. y mando popero SF - Super 4 SS - Super 6 M - Arranque manual con mando popero V - Alarma voz	S = 15" L = 20" X = 25"	D = 1983 E = 1984 F = 1985 G = 1986 H = 1987 J = 1988 K = 1989 L = 1990 M = 1991 N = 1992 P = 1993 R = 1994 S = 1995 T = 1996 V = 1997 W = 1998 X = 1999 Y = 2000 K1 = 2001 K2 = 2002 K3 = 2003 K4 = 2004 K5 = 2005 K6 = 2006 K7 = 2007 K8 = 2008

Ejemplo: DT40CRSN - 2-ciclo, 40 HP, Inyección aceite, Arranque eléctrico con control remoto, 15", Año1992

<p>Pack. de 10</p>  <p>18-5224 18-5224-9 ① CABLE TERMINAL ENCENDIDO</p>	 <p>18-5225 KIT CABLE BUJÍAS Kit incluye 25 pies. de cable de 7 MM Hypalon con cable encendido alma metálica y un largo surtido de 3 terminales diferentes para motores fueraborda.</p>	 <p>18-5226 CABLE ENCENDIDO Núcleo metálico Bobina 100' 7mm Hypalon</p>
<p>Pack. de 10</p>  <p>18-5750 18-5750-9 ① TAPA BUJÍAS UNIVERSAL Suministrado completo con conector terminal</p>	 <p>18-5752 TAPA BUJÍAS UNIVERSAL 8mm</p>	 <p>18-5151 BOBINA DE ENCENDIDO Reemplaza: 33410-94400, 33410-92L10 Para: DT40C(1986-98)</p>
 <p>18-5152 BOBINA DE ENCENDIDO Reemplaza: 32140-93900 Para: DT 9.9(1983-87), DT15 (1983-88)</p>	 <p>18-5144 CDI Reemplaza: 32900-93911 Para: DT15</p>	 <p>MP51010 (CLAMSHELL) MP51012 (CAJA 100 PCS/CTN) INTERRUPTOR ENCENDIDO Reemplaza: 37110-99E00 Colores de los cables iguales que los de fabrica Suzuki 2 & 4 tiempos fueraborda</p>

① Precio por envase



18-6414
ARRANQUE FUERABORDA
 Reemplaza: 31100-95600
 Para: 75 HP



18-6416
ARRANQUE FUERABORDA
 Reemplaza: 31100-94610
 Para: 115, 140 H.P. (9 dientes) (1984-SUP)



18-6417
ARRANQUE FUERABORDA
 Reemplaza: 31100-92E00
 Para: 150, 200, 225 H.P. (1985-SUP)



18-6419
ARRANQUE FUERABORDA
 Reemplaza: 31100-89J00
 Para: 4 tiempos DF40 (1999-01) (9 dientes)



18-6827
MOTOR ARRANQUE
 Reemplaza: 31100-94600, 31100-94601,
 31100-94610
 Para: motor 115, 140HP



18-6429
ARRANQUE FUERABORDA
 Reemplaza: 31100-94702
 Para: DT 55/65 (1985-88)



18-6831
MOTOR ARRANQUE
 Reemplaza: Suzuki 31100-90J00
 Hitachi S114-837, A
 Para: Suzuki 90-115HP 2001-08



18-6941
MOTOR ARRANQUE
 Reemplaza: 31100-93J00, 96J00, 96J01
 Para: 70-300HP 2004-sup



18-6945
MOTOR ARRANQUE
 Reemplaza: 31100-95J00, 95J01
 Para: Johnson, Suzuki 25HP 2006-11



18-56008
ACOPLAMIENTO
 Reemplaza: 31173-95310
 Para: 90-100, 150-225 HP 2 tiempos
 Use con motor arranque 18-6414



18-56009
ESCOBILLA
 Reemplaza: 31173-99E00
 Para: 115-140 HP 2 tiempos
 Use con motor arranque 18-6416



18-9802
LUZ CRONOMETRAJE
 Hasta 10,000 RPM's



18-18303
MOTOR POWER TRIM
 Reemplaza: 38100-92J02, 38100-92J10, 38100-93J01, 38100-93J02, 38100-96J00
 (Aro incluido)
 Para: DF60-300(2001-07)



18-18304
MOTOR POWER TRIM
 Reemplaza: 37100-87J00-0EP, 38100-87J0EP
 (Aro incluido)
 Para: DF40(1999-00), DF50(1999-00)



18-6793
MOTOR TRIM
 Reemplaza: 38100-87J11, 38100-87J20
 (Aro incluido)
 Para: DF40, DF50 (2001-08)



18-6785
MOTOR TILT/TRIM
 Reemplaza: 38100-87E10-0ED, 38100-87000-0IT, 38100-87E20-0ED
 (Aro incluido)
 Para: V-4 & V-6 1986-1990
 V-6/3 cables 3 tornillos



18-6786-1
MOTOR TILT/TRIM
 Reemplaza: 38100-87D10-0ED, 38100-87D10-35J, 38100-87D10-0IT, 38100-92E00-0ED
 Para: V4 & V6 (1990-sup), DT90 (1991-97), DT100 & DT200 (1991-2000), DT150 & DT225 (1991-2003), DT175 (1991-92)
 3 Tornillos 2 cable



18-6837
MOTOR TRIM
 Reemplaza: 38100-87J11, 38100-87J20
 Para: Motor 40-50HP 4-tiempos



18-6865
TRIM COMPLETO
 Reemplaza: 48600-94511-0ED
 Para: Motor con 3-Ram Trim Assembly, 115-225HP Motor Johnson/Evinrude



18-6823
CABLEADO
 Reemplaza: Universal
 Convierte de 3-cables a 2 cables



NEW
18-5731
RELÉ, MOTOR ARRANQUE
 Reemplaza: 38860-76F01
 Para: DF9.9 2005-2010, DF15 2005-2010, DF25 2006-2010, DF40 2003-2010, DF50 2003-2010, DF60 2003-2010, DF70 2003-2010, DF80 2009-2010, DF90 2003-2010, DF100 2009-2010, DF115 2003-2010, DF140 2003-2010, DF150 2006-2010, DF175 2006-2010, DF200 2004-2010, DF225 2004-2010, DF250 2004-2010, DF300 2007-2010

4-TIEMPOS KIT SISTEMA COMBUSTIBLE



18-7761
KIT RECUPERACIÓN CARBURADOR
 Para: Suzuki DF4-DF6 (2005 & Sup)



18-7773
KIT CARBURADOR
 Reemplaza: 13910-89J01
 Para: DF 25/30 (Todos los años)



18-3495
KIT DIAFRAGMA
 Reemplaza: 15170-93911
 Para: DT8(todos 1988-97), DT9.9(todos 1988-97), DT15(todos 1988-97)



18-3496
KIT DIAFRAGMA
 Reemplaza: 15170-94320
 Para: DT25 (todos 1989-99), DT30 (Todos 1989-99), DT40(Todos 1986-98), DT55(Todos 1988-97), DT65(Todos 1988-97)



18-3497
KIT DIAFRAGMA
 Reemplaza: 15170-91J00
 DF4-DF6 (2003 & SUP)



18-3498
KIT DIAFRAGMA
 Reemplaza: 15170-94J00, 15170-94J0V
 DF9.9-DF15 HP(2005 & SUP)



18-3499
KIT DIAFRAGMA
 Reemplaza: 15170-99E00
 DF9.9,DF15 (1997-2004), DF25 (2000-2006) (No-V doble), DF40,DF50 (1999-2006), DF60,DF70 (1998-2007),

2-TIEMPOS KITS SISTEMA COMBUSTIBLE

18-7752
KIT CARBURADOR
Reemplaza: 13910-87D00

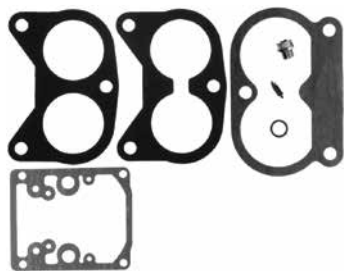

18-7753
KIT CARBURADOR
Reemplaza: 13910-94400



18-7754
KIT CARBURADOR
Reemplaza: 13910-94701



18-7755
KIT CARBURADOR
Reemplaza: 13910-95D00



APLICACIÓN KIT CARBURADOR

HP/Modelo	Año	Ref #	HP/Modelo	Año	Ref #	HP/Modelo	Año	Ref #
DT25C	1989-98	18-7755	DT65	1985-97	18-7753	DT100	1989-98	18-7752
DT30C	1988-97	18-7755	DT75	1985-97	18-7754	DT115	1986-98	18-7754
DT40C	1984-98	18-7753	DT85	1985-98	18-7753	DT140	1986-98	18-7753
DT55	1985-97	18-7754	DT90	1989-97	18-7752	V-6	TODOS	18-7752

SEPARADORES COMBUSTIBLE/AGUA



Sierra ofrece una amplia gama de filtros separadores de agua de 10 y 21 micras incluyendo la cazoleta de drenaje para proteger tu carburador y la inyección.

Los filtros separadores de agua eliminan cerca del 98,8% del agua emulsionada de la gasolina. Los filtros Sierra de 10 micras tienen una eficiencia de cerca del 90% eliminando pequeñas partículas tan pequeñas como 10 micras. Todos los filtros tienen un caudal de 90 GPH. Los filtros Sierra de 10 micras son ideales para prevenir posibles daños en intrabordas sensibles y fueraborda de inyección.

Sierra #	Suzuki #	Descripción
18-7953	15410-87J30	Filtro combustible Para: DF25, DF70, DF90, DF115, DF140 (Incl. 140T & 140Z) (2006 & Nuevo)
18-7936	15412-93J00	Elemento filtro combustible
18-7947	99105-20006	Filtro
18-7987	99105-20006-BWL	AquaVue™ Cazoleta mini
18-7948	99105-20005	Filtro
18-7922-1	99105-20004BWL	AquaVue™ Cazoleta
18-7735	15410-94400	Kit filtro combustible
18-7711	15410-96J00	Filtro combustible (En línea)
18-7716	15410-87J10	Filtro combustible
18-7719	15410-98500	Filtro combustible

NEW



18-32154
SENSOR OXÍGENO
reemplaza: 18213-98J00
Para: DF100A, DF115A, DF140A, DF250A,
(2011-Up), DF300 (2007-Sup)

BOMBA COMBUSTIBLE



18-8002EP-1
18-8002EP-1-10^①
BOMBA COMB.
 1/4"



18-8004EP-1
18-8004-10EP-1^①
BOMBA COMB.
 5/16"
 Bomba de gran capacidad

18-8005EP-1
18-8005-10PE-1^①
BOMBA COMB.
 3/8"
 Bomba de gran capacidad

18-80409
CONECTOR COMBUSTIBLE

• 1/4" manguera
 Tamaño motor
Reemplaza: 65720-94401
Para: DT4-DT65
 Acoplable 18-80418



18-80418
CONECTOR COMBUSTIBLE

• 1/4" manguera
Reemplaza: 65750-94404
Para: DT4-DT140
 Acoplable 18-80409, 18-8087 & 18-8090



18-80419
CONECTOR COMBUSTIBLE

Reemplaza: 65750-87J10, 65750-87J11
Para: DF25-DF140 (5/16" version de 18-80404)
 Acoplable 18-80425



18-80425
CONECTOR COMBUSTIBLE

Reemplaza: 65720-986B0
Para: DF25-DF140
 Acoplable 18-80404 & 18-80419



the evolution of the Sierra Brand

1966-2016



1966



1970



1982



1988



1993



1994



2003



2013



2016

 <p>18-8062 CONECTOR COMBUSTIBLE • 3/8" barb Reemplaza: 65750-98505 Adaptable 18-8071</p>	 <p>18-8071 CONECTOR COMBUSTIBLE 1/4" NPT .432 D.E Reemplaza: 99105-00192 Adaptable 18-8062 (macho)</p>	 <p>18-8078 CONECTOR DEPÓSITO 1/4" N.P.T .508 D.E Reemplaza: 65740-95500, 99105-00193 Para: Todos los modelos Adaptable 18-8079 (macho)</p>	 <p>18-8079 CONECTOR COMBUSTIBLE Terminal depósito Reemplaza: 65750-95510, 65750-95500 Para: Todos los modelos Acopable 18-8078 hembra 3/8" manguera</p>
 <p>18-8087 CONECTOR COMBUSTIBLE • 3/8" barb Lado motor Reemplaza: 65720-94411 Para: DT75-DT140 Adaptable 18-80418</p>	 <p>18-80404 CONECTOR COMBUSTIBLE 3/8" Para: DF25-DF140 HP Adaptable 18-80425</p>	 <p>18-80405 CONECTOR COMBUSTIBLE hembra 3/8" manguera Adaptable 18-8078</p>	 <p>18-8090 CONECTOR COMBUSTIBLE (1/4" NPT) Adaptable 18-80418</p>
 <p>18-3000 IMPULSOR Reemplaza: 17461-92D02 Para: DT 8C/9.9C (1989-97)</p>	 <p>18-3035 IMPULSOR Reemplaza: 17461-93J00 Para: DF200, DF225, DF250 (2004-05)</p>	 <p>18-3049 IMPULSOR Reemplaza: 17461-87E11, 17461-87E12 Para: DF 60/70 (1998-01), DF 90-100 (1989-01)</p>	 <p>18-3023 IMPULSOR Reemplaza: 17461-90J00, 17461-90J01, 17461-94500, 17461-94501, 17461-94502, 17461-94503, 17461-94504, 17461-94505, 17461-94506, 17461-94510, 17461-94511, 17461-94520 Para: 2 tiempos DF90, DF115, DF140 (2000-05), DT115 (1981-01), DT140 (1981-01), DT150 (1986-01), DT200 (1986-00)</p>
 <p>18-3092 IMPULSOR Reemplaza: 17461-93001, 17461-93003, 17461-93004</p>	 <p>18-3094 IMPULSOR Reemplaza: 17461-94700, 17461-94701</p>	 <p>18-3095 IMPULSOR Reemplaza: 17461-95300, 17461-95301, 17461-95302</p>	 <p>18-3096 IMPULSOR Reemplaza: 17461-96301, 17461-96311, 17461-96312</p>
 <p>18-3097 IMPULSOR Reemplaza: 17461-98501, 17461-98502, 17461-98503, 17461-985M0</p>	 <p>18-3099 IMPULSOR Reemplaza: 17461-93902, 17461-93901, 17461-93903 Para: DT 9.9, 15 (1983-97), DF 9.9, 15 (1997-05)</p>	 <p>18-3291 LLAVE IMPULSOR Reemplaza: 09420-05006, 09420-05009 Para: V-6 2-tiempos (1986-03), DF90 /115/140(2001-04)</p>	 <p>18-3292 LLAVE IMPULSOR Reemplaza: 17462-93990, 09420-03005 Para: DT 8C/9.9C (1989-97), DF 9.9/15 (1997-04), DT 9.9 (1985-87), DT 15 (1983-88), DT 15C (1989-97)</p>
 <p>18-3296 LLAVE IMPULSOR Reemplaza: 09420-05005 Para: DT 115/140 (1983-01)</p>	 <p>18-3404 LLAVE IMPULSOR Reemplaza: 09420-04009 Para: DF 60/70 (1998-01), DF 90-100 (1989-01)</p>	 <p>18-3188 PLATINA IMPULSOR Reemplaza: 17471-98503 Para: DT 6 (1984-02), DT 8 (1986-97)</p>	 <p>18-3189 PLATINA IMPULSOR Reemplaza: 17471-87D01 Para: V-6 2-tiempos (1986-03)</p>



18-3190
PLATINA IMPULSOR
 Reemplaza: 17471-93902
 Para: DF 9.9/15 (1997-04), DT 9.9 (1985-87),
 DT 15 (1983-88), DT 15C (1989-97)



18-3191
PLATINA IMPULSOR
 Reemplaza: 17471-94501
 Para: DT 115/140 (1983-01)



18-3192
PLATINA IMPULSOR
 Reemplaza: 17471-87E01, 17471-92J00
 Para: DF 60/70 (1998-01), DF 90-100
 (1989-01), DF 90/115/140 (2001-04)



18-3193
PLATINA IMPULSOR
 Reemplaza: 17471-92D10
 Para: DT 8C/9.9C (1989-97)



18-3242
KIT REPARACIÓN IMPULSOR
 Reemplaza: 17400-96350,
 17400-96351, 17400-96353



18-3243
KIT REPARACIÓN IMPULSOR
 Reemplaza: 17400-94700, 17400-94701

— CONTIENE —

Ref #	Descripción	O.E. #
18-3096	Impulsor	17461-96311
18-0461	Juntas	17472-96301

MODELO	AÑO	MODELO	AÑO
DT20	1986-88	DT35	1987-89
DT25	1984-88	DT40C	1984-88
DT30	1984-87		

— CONTIENE —

Ref #	Descripción	O.E. #
18-3094	Impulsor	17461-94700
18-0460	Juntas	17472-95310

MODELO	AÑO	MODELO	AÑO
DT55	1985-95	DT65	1985-95



18-3244
KIT REPARACIÓN IMPULSOR
 Reemplaza: 17400-95550, 17400-95350, 17400-95351
 Para: DT75, DT85 (1985-95)



18-3253
KIT BOMBA DE AGUA
 Reemplaza: 17400-87D11
 Para: V6 2-tiempos (1986-03)

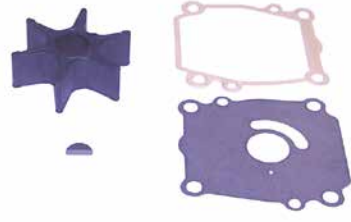

18-3254
KIT BOMBA DE AGUA
 Reemplaza: 17400-87E03, 17400-87E04
 Para: DF 60/70 (1998-06), DT 90-100 (1989-01)



18-3255
KIT BOMBA DE AGUA
 Reemplaza: 17400-92D01
 Para: DT 8C/9.9C (1989-97)



18-3256
KIT BOMBA DE AGUA
 Reemplaza: 17400-93951
 Para: DF 9.9/15 (1997-06), DT 9.9 (1985-87),
 DT 15 (1983-88), DT 15C (1989-97)



18-3257
KIT BOMBA DE AGUA
 Reemplaza: 17400-94611
 Para: DT 115/140 (1983-01)



18-3258
KIT BOMBA DE AGUA
 Reemplaza: 17400-90J11, 17400-90J20
 Para: DF 90/115/140 (2001-05)



18-3259
KIT BOMBA DE AGUA
 Reemplaza: 17400-98551
 Para: DT 6 (1984-02), DT8 (1986-97)



18-3260
KIT BOMBA DE AGUA
 Reemplaza: 17400-98652
 Para: DT 4 (1984-98), DT 5 (1999-02)



18-3264
KIT REPARACIÓN BOMBA DE AGUA
 Reemplaza: 17400-93J00,
 17400-93J02
 Para: DF200, DF225, DF250 (2004-09)

APLICACIÓN IMPULSOR EN LA SIGUIENTE PÁGINA



18-3266
KIT REPARACION BOMBA DE AGUA
 Reemplaza: 17400-98661
 Para: DF4, DF6 (2003-07)



18-3267
KIT BOMBA DE AGUA
 Reemplaza: 17400-98J00,
 17400-98J01
 Para: DF300 (2007-Actual)



18-3480
BOMB. AGUA ALOJ.
 Reemplaza: 17411-93901
 Para: DT9.9(1983-87, 2004-10),
 DT15(1983-97, 2004-10)



18-3481
BOMB. AGUA ALOJ.
 Reemplaza: 17411-94421
 Para: DF25(Todos modelos 2000-05)
 DF25(modelos DF25Q, DF25Q(QR),
 DF25T 2006-07), DF30(Todos 2000-
 07), DT40C(1986-98), DF40(Todos
 2000-07), DF50(Todos 1999-10)



18-0761
JUNTA BOMBA
 Reemplaza: 17472-91J00
 Para: DF4 (2003-05), DF6
 (2003-05)



18-0778
JUNTA BOMBA
 Reemplaza: 17472-93J00
 Para: DF150(2006-10),
 DF175(2006-10), DF200(2004-10),
 DF225(2004-10), DF250(2004-10)



18-0459
JUNTA BOMBA
 Reemplaza: 17472-95200



18-0460
JUNTA BOMBA DE AGUA
 Reemplaza: 17472-95310



18-0461
JUNTA BOMBA DE AGUA
 Reemplaza: 17472-96301



Pack. de 5
18-0477-9^①
JUNTA BOMBA DE AGUA
 Reemplaza: 17472-98503
 Para: DT 6 (1984-02), DT8 (1986-97)



18-0478
JUNTA BOMBA DE AGUA
 Reemplaza: 17472-93911
 Para: DF 9.9/15 (1997-04), DT 9.9
 (1985-87), DT 15 (1983-88),
 DT 15C (1989-97)



18-0479
JUNTA BOMBA DE AGUA
 Reemplaza: 17472-92D10
 Para: DT 8C/9.9C (1989-97)



18-0480
JUNTA BOMBA DE AGUA
 Reemplaza: 17472-98611
 Para: DT 4 (1984-98), DT 5 (1999-02)



18-0792
JUNTA TERMOSTATO
 Reemplaza: 13119-91J00



18-0793
JUNTA TERMOSTATO
 Reemplaza: 17582-93J00



18-0794
JUNTA TERMOSTATO
 Reemplaza: 17685-97J00



18-0795
JUNTA TERMOSTATO
 Reemplaza: 17685-89J00



18-0796
JUNTA TERMOSTATO
 Reemplaza: 17685-99E00



18-0797
JUNTA TERMOSTATO
 Reemplaza: 17685-87D10

HP/Modelo	Año	Impulsor	Junta	kit bomba de agua	HP/Modelo	Año	Impulsor	Junta	Kit bomba de agua
DT2/2.2	1983-97	18-3097	—	—	DT50M	1980-84	18-3094	18-0460	18-3243
DT3.5	1983-84	18-3097	—	—	DF50	1999-09	18-3096	18-0461	18-3242
DT4	1984-98	18-3097	18-0480	18-3260	DF50	2010	18-3096	18-0461	—
DF4	2003-10	18-3097	18-0761	18-3266	DT55	1985-97	18-3094	18-0460	18-3243
DT5	1977-83, 1999-02	18-3097	18-0480	18-3260	PU55 (jet)	1989-94	18-3094	18-0460	—
DT6	1984-02	18-3097	18-0477-9	18-3259	DT60	1983	18-3094	18-0460	18-3243
DF6	2003-10	18-3097	18-0761	18-3266	DT60	1984	18-3095	18-0460	—
DT8	1980-87	18-3097	18-0477-9	18-3259	DF60	1998-09	18-3049	—	—
DT8	1988-97	18-3000	18-0479	18-3255	DF60	2010	18-3096	18-0461	—
DF8	2010	18-3099	—	—	DT65	1982-prior	18-3094	18-0459	—
DT9.9	1977-82	18-3092	—	—	DT65	1985-97	18-3094	18-0460	18-3243
DT9.9	1983-87	18-3099	18-0478	18-3256	DF70	1998-09	18-3049	—	—
DT9.9	1988-97	18-3000	18-0479	18-3255	DF70	2010	18-3096	18-0461	—
DF9.9	1997-10	18-3099	18-0478	18-3256	DT75	1983-97	18-3095	18-0459	18-3244
DT14	1977-80	18-3092	—	—	DF80	2009-10	18-3049	—	—
DT15	1983-97	18-3099	18-0478	18-3256	DT85	1983-00	18-3095	18-0459	18-3244
DT15C	1989-97	18-3099	18-0478	—	PU85 (jet)	1989-97	18-3095	18-0459	—
DF15	1997-10	18-3099	18-0478	18-3256	DT90	1989-97	18-3049	—	18-3254
DT16	1977-82	18-3092	—	—	DF90	2001-08	18-3023	—	—
DT20	1986-88	18-3096	18-0461	18-3242	DF90	2009-10	18-3049	—	—
DT25	1980-82	18-3092	—	—	DT100	1987-01	18-3049	—	18-3254
DT25	1983-88	18-3096	18-0461	18-3242	DF100	2009-10	18-3023	—	—
DF25	2000-06	18-3096	18-0461	18-3242	DT115	1986-01	18-3023	—	18-3257 **
DF25 V-Twin	2006-10	18-3096	18-0461	—	DF115	2001-10	18-3023	—	18-3258 *
DT30	1983-87	18-3096	18-0461	18-3242	DT140	1986-01	18-3023	—	18-3257
DT30	1988-97	—	18-0461	—	DF140	2002-10	18-3023	—	—
DF30	2000-07	18-3096	18-0461	18-3242	DT150	1986-03	18-3023	—	18-3253
DT35	1980-82	18-3094	18-0459	—	DF150	2006-10	18-3023	18-0778	—
DT35	1987-89	18-3096	18-0461	18-3242	DT175	1987-92	18-3023	—	18-3253
DT40	1980-82	18-3094	18-0459	—	DF175	2006-10	18-3023	18-0778	—
DT40	1983	18-3096	18-0460	—	DT200	1986-00	18-3023	—	18-3253
DT40/DT40C	1984-98	18-3096	18-0461	18-3242	DF200	2004-10	18-3035	18-0778	18-3264
DF40	1999-09	18-3096	18-0461	18-3242	DT225	1990-03	18-3023	—	18-3253
DF40	2010	18-3096	18-0461	—	DF225	2004-10	18-3035	18-0778	18-3264
PU40 (jet)	1989-94	18-3096	18-0461	—	DF250	2004-10	18-3035	18-0778	18-3264
DT50	1982-prior	18-3094	18-0459	—	DF300	2007-10	18-3035	18-0651	18-3267
DT50	1983-84	18-3094	18-0460	18-3243					

① Precio por envase

* SN 681517 & anterior

** SN 812175 & posterior



O.E. INTERCAMBIO		
Ref #	Descripción	O.E. #
18-39480	Aros pistón	12140-93121
18-39530	Aros pistón	12140-96351-050
18-39540	Aros pistón	12140-94400
18-40110	Kit Pistón	12110-94400
18-40140	Kit Pistón	12110-93120
18-42850	Pasador pistón	12151-94400
18-42860	Pasador	12151-93100
18-42870	Pasador	12151-92502
18-42940-9	Clips	09381-14001
18-42950-9	Clips	09381-18002
18-42960-9	Clips	09381-20003

HP/Modelo	Año	PISTON		AROS		PASADOR		CLIPS	
		Std.	.50mm	Std.	.50mm	Std.	.50mm	Std.	.50mm
DT9.9	1983-87	18-40140	—	18-39480	—	18-42860	—	18-42940-9	—
DT15	1983-88	18-40140	—	18-39480	—	18-42860	—	18-42940-9	—
DT25	1983-88	—	—	—	18-39530	—	18-42870	—	18-42950-9
DT30	1983-87	—	—	—	18-39530	—	18-42870	—	18-42950-9
DT40	1984-98	18-40110	—	18-39540	—	18-42850	—	18-42960-9	—

 18-1757 BIELA Reemplaza: 12161-93902 Para: DT9.9, DT15 (1983-97)	 18-1758 BIELA Reemplaza: 12161-96300, 12161-91L00 Para: DT25 (1983-88), DT30 (1983-87)	 18-1759 BIELA Reemplaza: 12161-94400, 12161-92L00 Para: DT 40 (1984-98)	 18-1757K KIT CONEXIÓN Reemplaza: 12161-93902 Para: DT9.9 (1983-87), DT15 (1983-97)
---	--	---	---

 18-1759K KIT CONEXIÓN Reemplaza: 12161-94400 Para: DT40 (1986-98)	 18-1412 COJINETE Reemplaza: 09263-20051 Para: DT9.9 (1983-87), DT15 (1983-97)	 18-1414 COJINETE Reemplaza: 09263-14022 Para: DT9.9 (1983-87), DT15 (1983-97), DT14/16 (1980-82)	 18-1415 COJINETE Reemplaza: 09263-18016 Para: DT25 (1983-88), DT30 (1983-87)
--	--	--	---

 18-1416 COJINETE Reemplaza: 09263-27005 Para: 40 (1984-98)	 18-1417 COJINETE Reemplaza: 09263-20072 Para: 40 (1984-98)	 18-3806 JUNTA CULATA Reemplaza: 11141-98401, 11141-98411	 18-3807 JUNTA CULATA Reemplaza: 11141-98101, 11141-98130
---	---	--	--

 18-3808 JUNTA CULATA Reemplaza: 11141-93901, 11141-93960	 18-3809 JUNTA CULATA Reemplaza: 11141-96303, 11141-96344	 18-3810 JUNTA CULATA Reemplaza: 11141-94401, 11141-94450	 18-3813 JUNTA CULATA Reemplaza: 11141-95305, 11141-95320
--	--	--	--



18-3814
JUNTA CULATA
Reemplaza: 11141-95505, 11141-95512



18-3816
JUNTA CULATA
Reemplaza: 11141-98504, 11141-98510, 11141-98522



18-3817
JUNTA CULATA
Reemplaza: 11141-92D01, 11141-92D10

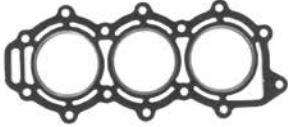

18-3819
JUNTA CULATA
Reemplaza: 11141-95D90, 11141-95D10



18-3820
JUNTA CULATA
Reemplaza: 11141-94701, 11141-94702, 11141-94720

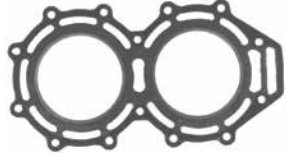

18-3822
JUNTA CULATA
Reemplaza: 11141-87E90, 11141-87E10



18-3823
JUNTA CULATA
Reemplaza: 11141-94506, 11141-94620



18-3824
JUNTA CULATA
Reemplaza: 11141-94600, 11141-94620



18-3825
JUNTA CULATA
Reemplaza: 11141-87D90, 11141-87D60

Modelo	Año	Cil	Junta Culata	Modelo	Año	Cil	Junta Culata	Modelo	Año	Cil	Junta Culata
2	1983-89	1	18-3806	25	1989	3	18-3819	85	1983-87	3	18-3814
5	1983	2	18-3816	30	1983-87	2	18-3809	90	1989	V-4	18-3822
6	1984-89	2	18-3807	30	1988-89	3	18-3819	100	1989	V-4	18-3822
8	1983-87	2	18-3807	35	1987-89	2	18-3810	115	1983-85	4	18-3823
8	1988-89	2	18-3817	40	1984-89	2	18-3810	115	1986-89	4	18-3824
9.9	1983-87	2	18-3808	50	1984	2	18-3813	140	1983-85	4	18-3823
9.9	1988-89	2	18-3817	55	1985-89	3	18-3820	140	1986-89	4	18-3824
15	1983-89	2	18-3808	65	1985-89	3	18-3820	150	1986	V-6	18-3825
25	1983-88	2	18-3809	75	1983-87	3	18-3814	200	1986	V-6	18-3825



18-7895
FILTRO ACEITE
Reemplaza: 16510-93J00
Rosca: 3/4" x 16NPT



18-7896
FILTRO ACEITE
Reemplaza: 16510-61A20-MHL
Para: DF70A, DF80A, DF90A, DF90-DF115



18-7897
FILTRO ACEITE
Reemplaza: 16510-82703
Para: DF140



18-7903
FILTRO ACEITE
Reemplaza: 16510-05240
Reemplaza: DF9.9, DF15 (1996-06)



18-7905
FILTRO ACEITE
Reemplaza: 16510-96J00
Para: DF150-DF300



18-7915-1
FILTRO ACEITE
Reemplaza: 16510-87J00
Para: DF25-DF70



18-8870
FILTRO ACEITE
Reemplaza: 16510-45H10
Para: F9.9 Tipo T/TH(Sn 110001 & nuevo), F15(SN 110001 & Nuevo)



18-0650
JUNTA ALOJAMIENTO
RETÉN DE ACEITE
 Reemplaza: 56132-95J00
 Para: F 25 V-Twin (2006-07)



18-0651
JUNTA PANEL
BOMBA
 Reemplaza: 17472-98J00
 Para: F300 (2007)

Pack. de 5



18-8331
18-8331-9①
JUNTA TORNILLO DRENAJE
 Reemplaza: 09168-10022



18-8334
RETÉN EJE HÉLICE
 Reemplaza: 25223-94400

Pack. de 10



PASADOR

Ref #	Reemplaza
18-3737 ②	09204-02004
Para: DT9.9 & 15C, DF9.9 & 15, 8 & 9.9C inyección aceite	
18-3735 ②	09204-03003, 09204-03004
Para: DT20, 25C, 30C	



18-3726
TUERCA HÉLICE
 Reemplaza: 09141-18005



18-3710
TUERCA HÉLICE
 Reemplaza: 09141-14008



18-3774
KIT TUERCA HÉLICE
 Reemplaza: 57630-94500
 Para: DT75/85/90/100/115, 140 con stilo V, DF60/70 con stilo V

— CONTIENE —		
Ref #	O.E. #	Desc.
18-3726	09141-18005	Tuerca
18-3735	09204-03003, 09204-03004	Pasador
—	09160-18028	Arandela
—	57633-94500	Espaciador



18-3775
KIT TUERCAS HÉLICE
 Reemplaza: 57630-92E00
 Para: V-6

— CONTIENE —		
Ref #	O.E. #	Descripción
18-3726	09141-18005	Tuerca
18-3735	09204-03003, 09204-03004	Pasador
—	09160-18019	Arandela
18-3795	57633-87D30	Espaciador



18-3777
KIT TUERCAS HÉLICE
 Reemplaza: 57630-94300
 Para: DT40/55/65

— CONTIENE —		
Ref #	O.E. #	Descripción
18-3726	09141-18005	Tuerca
18-3735	09204-03003, 09204-03004	Pasador
—	09160-18028	Arandela



18-3778
KIT TUERCA HÉLICE
 Reemplaza: 57630-96300
 Para: DT20/25C/30C

— CONTIENE —		
Ref #	O.E. #	Descripción
18-3735	09204-03003, 09204-03004	Pasador
—	09160-14028	Arandela
18-3710	09141-14008	Tuerca
—	57633-96300	Espaciador



③ **18-6032**
ÁNODO
 Reemplaza: 55320-95310
 55-140 HP



③ **18-6033**
ÁNODO
 Reemplaza: 55125-87D00
 150-200 HP



③ **025844**
ÁNODO
 Reemplaza: 55125-96310
 DF25, DF30, DT20, DT25, DT25C, DT30, DT30C, DT35



⑤ **18-6161A**
 ④ **18-6161M**
KIT ÁNODO
 Para: Suzuki 90-140HP



18-79989
STICKS ARRASTRE
 Para: Mayoría fuerabordas 150hp con tilt/trim integral.



18-8380
KIT RETENES PARTE INFERIOR
 Reemplaza: 25700-93J00
 Para: Todos DF150/DF175/DF200/DF225/DF250

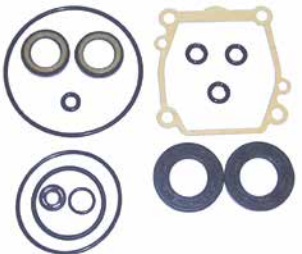

18-8381
KIT RETENES PARTE INFERIOR
 Reemplaza: 25700-99E00
 Para: DF 60(2001 & Sup), DF70(2001 & Sup)

① Precio por envase ② Precio por pieza. Para pedir envasado añada 9 al final de la referencia
 ⑤ Aluminio ④ Magnesio ③ Zinc

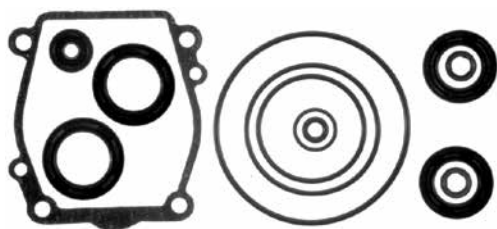

18-8335
KIT RETENES UNIDAD INFERIOR
 Reemplaza: 25700-87D00

-- CONTIENE --

Ref #	Descripción	O.E. #	Cant.
18-7118	Aro	09280-08008	1
18-7183	Aro	09280-69001	1
18-8331	Junta tornillo drenaje	09168-10022	2
18-7440-1	Aro	—	1
18-0544	Retén aceite	09282-24004	2



18-8337
KIT RETENES UNIDAD INFERIOR
 Reemplaza: 25700-94400

-- CONTIENE --

Ref #	Descripción	O.E. #	Cant.
18-0461	Junta bomba de agua	17472-96301	1
18-7151	Aro	09280-75001	1
18-7413	Aro	09280-08005	2
18-8331	Junta tornillo drenaje	09168-10022	3
18-8334	Retén eje gas	25223-94400	1
18-8345	Retén	09289-22007	2
18-7180	Aro	—	1

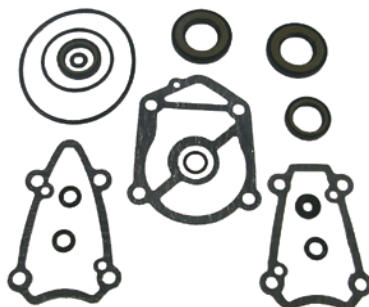

18-8338
KIT RETENES UNIDAD INFERIOR
 Reemplaza: 25700-94500

-- CONTIENE --

Ref #	Descripción	O.E. #	Cant.
18-7118	Aro	09280-08008	1
18-8331	Junta tornillo drenaje	09168-10022	3
18-7182	Retén aceite	—	1
18-7133	Aro	—	1

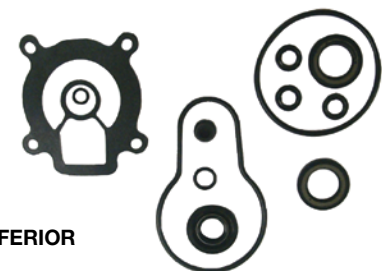

18-8339
KIT RETENES UNIDAD INFERIOR
 Reemplaza: 25700-94700

-- CONTIENE --

Ref #	Descripción	O.E. #	Cant.
18-0460	Junta bomba de agua	17472-95310	1
18-7151	Aro	09280-76006	1
18-7180	Aro	—	1
18-7413	Aro	09280-08005	1
18-8329	Retén	09289-17005	1
18-8331	Junta tornillo drenaje	09168-10022	3
18-8334	Retén eje gas	25223-94400	1
18-8345	Retén	09289-22007	2

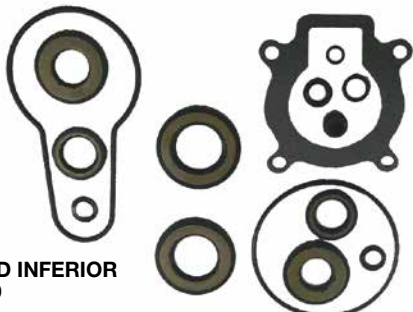

18-8340
KIT RETENES UNIDAD INFERIOR
 Reemplaza: 25700-95500

-- CONTIENE --

Ref #	Descripción	O.E. #	Cant.
18-0459	Junta bomba de agua	17472-95200	1
18-8331	Junta tornillo drenaje	09168-10022	3
18-8334	Retén eje gas	25223-94400	1
18-7180	Aro	—	1
18-7413	Aro	09280-08005	1
18-7127	Aro	—	1

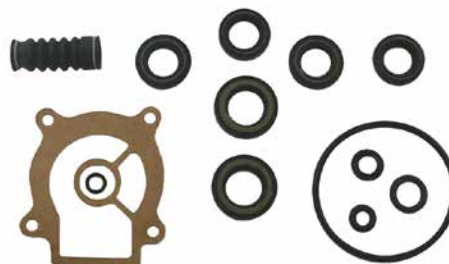

18-8341
KIT RETENES UNIDAD INFERIOR
 Reemplaza: 25700-95D00

-- CONTIENE --

Ref #	Descripción	O.E. #	Cant.
18-0461	Junta bomba de agua	17472-96301	1
18-7118	Aro	09280-50005	1
18-7413	Aro	09280-08005	1
18-7140	Aro	09282-17006	1
18-8331	Junta tornillo drenaje	09168-10022	3



18-8373
KIT RETENES UNIDAD INFERIOR
 Reemplaza: 25700-90J01
 Para: DF 90/115 todos los años



18-8374
KIT RETENES UNIDAD INFERIOR
 Reemplaza: 25700-92J00
 Para: DF140 (Todos los años)



18-8385
KIT RETENES
 Reemplaza: 25700-95J00
 Para: DF25 V-Twin (2006-07)

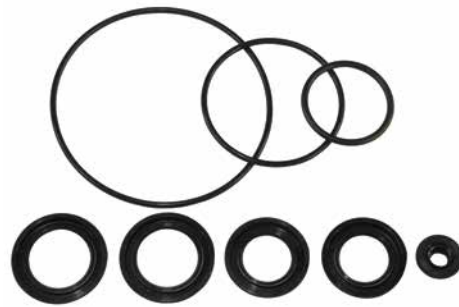

18-8386
KIT RETENES
 Reemplaza: 25700-98J00
 Para: DF300 (2007)

APLICACIÓN KIT RETENES

HP/MODELO	Año	Ref #	HP/MODELO	Año	Ref #
DT25C	Todos	18-8341	DT115	Todos	18-8338
DF25	Todos	18-8341	DF115	Todos	18-8373
DF25 V-Twin	2006-07	18-8385	DT140	Todos	18-8338
DT30C	Todos	18-8341	DF140	Todos	18-8374
DF30	Todos	18-8341	DT150	Todos	18-8335
DT40C	Todos	18-8337	DF150	Todos	18-8380
DF40	Todos	18-8337	DT175	Todos	18-8335
DF50	Todos	18-8337	DF175	Todos	18-8380
DT55	Todos	18-8339	DT200	Todos	18-8335
DF60	2001-07	18-8381	DF200	Todos	18-8380
DT65	Todos	18-8339	DT225	Todos	18-8335
DF70	2001-07	18-8381	DF225	Todos	18-8380
DT75	18-8340		DF250	Todos	18-8380
DT85	Todos	18-8340	DF300	Todos	18-8386
DF90	Todos	18-8373			

Pack. de 2



RETÉN ACEITE

Pack. de 5

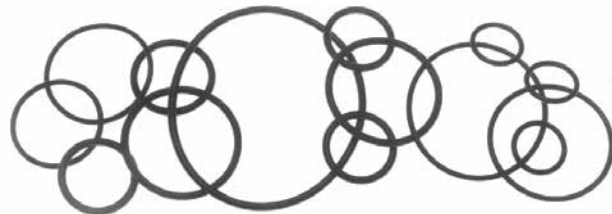



ARO

Ref #	O.E. #	D.I.	Dimensiones D.E. (mm)	Ancho
18-0544	09282-24004	23.2	40.3	7
18-0545	09289-10002	9	22.2	8
18-0546	09282-30007	29.5	50.25	6
18-0551	09283-10011	9	22.2	8
18-0569	09284-08003			
18-8345	09289-22007	22.2	35	5
18-8375		29	45	6
18-8377		7	22	7
18-8378		8	22	7

Referencia	O.E. No.	D. I.	Dimensiones Ancho (mm)
18-7118 ①	09280-08008	69.40	3.10
18-7140 ①	09280-75002	69.00	3.50

① Precio por pieza. Para ordenarlo pida la misma ref. acabada en 9.

MOD.-HP	AÑO	Ref. CHAMPION	Ref. PRONAUTIC	MOD.-HP	AÑO	Ref. CHAMPION	Ref. PRONAUTIC
DT2	1977-96	L90C	051028	DT150 V6 EFI	1986-94	QL78C/L78C	050915/050907
DT2.2	1997+	L90C	051028	DT175 V6	1991-93	QL78C/L78C	050915/050907
DT3.5	1979-84	QL87YC/L87YC	050920/050938	DT200 EFI	1986+	QL78C/L78C	050915/050907
DT4	1985-98	QL87YC/L87YC	050920/050938	DT225 EFI	1991+	QL78C/L78C	050915/050907
DT4.5	1977+	QL86C/L86C	050919/050910	4 TIEMPOS			
DT5	1978-83	QL87YC/L87YC	050920/050938	DF4	2003-04	RN9YC	050948
DT5Y	1999-01	QL82YC/L82YC	050918/050909	DF6	2003-04	RN9YC	050948
DT6	1984-97	QL87YC/L87YC	050920/050938	DF9.9	1997-04	RA8HC	050957
DT6	1998-01	QL87YC/L87YC	050920/050938	DF15	1997-04	RA8HC	050957
DT7.5	1977-79	QL86C/L86C	050919/050910	DF25	2000-04	RA8HC	050957
DT8	1980-87	QL87YC	050920	DF30	2000-04	RA8HC	050957
DT9	1977-79	QL86C/L86C	050919/050910	DF40	1999-04	RA8HC	050957
DT9	1993	QL86C/L86C	050919/050910	DF50	1999-04	RA8HC	050957
DT9.9C	1983-97	QL82C/L82C	050918/050909	DF60	1998-04	RN9YC	050948
DT15	1983-88	QL86C	050919	DF70	1998-04	RN9YC	050948
DT15C	1989-97	QL82C	050918	DF90	2001-04	RC9YC	050943
T16	1977-82	QL86C/L86C	050919/050910	DF115	2001-04	RC9YC	050943
DT20	1977-88	QL82C/L82C	050918/050909	DF140	2002-04	RC9YC	050943
DT25C	1977-00	QL82C/L82C	050918/050909				
DT30C	1989+	QL82C/L82C	050918/050909				
DT35	1989+	QL82C/L82C	050918/050909				
DT40	1980-98	QL78C/L78C	050915/050907				
DT50	1997-84	QL78C/L78C	050915/050907				
DT55	1985-97	QL78C/L78C	050915/050907				
DT60	1983-84	QL78C/L78C	050915/050907				
DT65	1978-97	QL78C/L78C	050915/050907				
DT75	1983-97	QL78C/L78C	050915/050907				
DT85	1979-97	QL78C/L78C	050915/050907				
DT85	1998+	QL78C/L78C	050915/050907				
DT90 V4	1989-97	QL78C/L78C	050915/050907				
DT100 V4	1989-01	QL78C/L78C	050915/050907				
DT115 Carb	1981-97	QL78C/L78C	050915/050907				
DT115 EFI	1996-01	QL78C/L78C	050915/050907				
DT115S EFI	1998+	QL78C/L78C	050915/050907				
DT140 Carb	1981-96	QL78C/L78C	050915/050907				
DT140 EFI	1997-01	QL78C/L78C	050915/050907				

SUZUKI 				SUZUKI 			
MOD. -HP	AÑO	Ref. NGK	Ref. PRONAUTIC	MOD. -HP	AÑO	Ref. NGK	Ref. PRONAUTIC
DT2	1986-90	BR4HS	050830	DT15K	-1985	BR6HS	050714
DT2	1991-99	BR5HS	050892	DT15K	1986+	B6HS	050804
DT2.2	1992+	BR5HS	050892	DT20	1997-00	BR7HS-10	050832
DT4	1988-92	BP5HS	050855	DT20/P	-1985	BR7HS	050853
DT4	1993-01	BPR5HS	050874	DT20/P	1986+	BR7HS-10	050832
DT4.5		BR6HS	050714	DT20K	-1985	BR7HS-10	050832
DT4L/S	1994+	BPR5HS	050874	DT20K	1986-87	B7HS-10	050807
DT4L/S	-1993	BP5HS	050855	DT25	-1985	BR7HS	050853
DT5	1986-92	BP6HS	050820	DT25	2000-01	BR7HS-10	050832
DT5	1993-94	BPR6HS	050827	DT25C	1989-97	BR7HS-10	050832
DT5	1995-00	BR6HS	050714	DT25E	1983-85	BPR7HS-10	050843
DT5W	1986-92	BR6HS	050714	DT25E	-1982	B7HS	050806
DT5Y	1998-01	BPR7HS-10	050843	DT25E	1986+	BR7HS-10	050832
DT6	1986-92	B6HS-10	050732	DT25K	1986+	BR7HS-10	050832
DT6	1993-02	BR6HS	050714	DT28P/DT28/ DT28E		B7HS	050806
DT6	-1985	B6HS	050804	DT30	1986+	BR7HS-10	050832
DT6	1995-99	BR6HS-10	050880	DT30	1983-85	BR7HS-10	050832
DT6S/5PS	-1992	B6HS	050804	DT30C	1988-00	BR7HS-10	050832
DT7.5		BR6HS	050714	DT30E	1983+	BR7HS-10	050832
DT8	1986-02	BPR6HS	050827	DT40	-1983	B8HS	050809
DT8C	1988-97	BR6HS-10	050880	DT40C	1986-99	B8HS-10	050810
DT9		B6HS-10	050732	DT40C/CR/TC	1998+	B8HS-10	050810
DT9.9	1986-99	BR7HS-10	050832	DT40W	1995+	B7HS-10	050807
DT9.9	1977-78	B7HS	050806	DT40WK	1998+	B7HS-10	050807
DT9.9	1979-84	BR6HS	050714	DT40WK	-1997	B7HS	050806
DT9.9	1976	B6HS	050804	DT48M	2001+	B8HS-10	050810
DT9.9C	1988-97	BR6HS-10	050880	DT48M	-2000	B8HS	050809
DT9.9E	1982+	B6HS	050804	DT50	1979-83	B8HS	050809
DT9.9E	1984+	B7HS	050806	DT50	-1978	B7HS	050806
DT9.9E	1983+	BR7HS-10	050832	DT50	1984-89	B8HS-10	050810
DT9.9K	1985-86	B6HS	050804	DT50ACR	1994-96	B8HS-10	050810
DT9.9K	-1985	BR6HS	050714	DT50ACR	1993	BR8HS	050854
DT9.9K	1986-90	B6HS	050804	DT50C	1984-00	B8HS-10	050810
DT9.9P	-1983	BPR6HS	050827	DT50K		B7HS	050806
DT15	1986-02	BR7HS-10	050832	DT50M/DT50	1986-89	B8HS-10	050810
DT15C	1989-97	BR7HS-10	050832	DT50M/DT50	-1985	B8HS	050809

SUZUKI**SUZUKI**

MOD. -HP	AÑO	Ref. NGK	Ref. PRONAUTIC	MOD. -HP	AÑO	Ref. NGK	Ref. PRONAUTIC
DT50M/DT50	2001+	BR8HS-10	050835	DT90TC	1996-97	BR8HS	050854
DT55C	1988-98	BR8HS-10	050835	DT90TC	-1995	BR8HCS-10	050737
DT55M/MQ	-2000	B8HS	050809	DT90TC	1998+	BR8HS-10	050835
DT55M/MQ	2001+	BR8HS-10	050835	DT100	2001+	BR8HS-10	050835
DT55TC/CRQ	1998+	BR8HS-10	050835	DT100	1996-00	BR8HS-10	050835
DT60		B8HS-10	050810	DT100	1990-95	BR8HCS-10	050737
DT60C	2001+	BR8HS-10	050835	DT100	2000	BR8HCS-10	050737
DT60C	1986-87	B8HS-10	050810	DT100TC	-1995	BR8HCS-10	050737
DT65/T	-1983	BR8HS	050854	DT100TC	1998+	BR8HS-10	050835
DT65C	1988-99	BR8HS-10	050835	DT100TC	1996-97	BR8HS	050854
DT65TC	1994-95	BR8HS-10	050835	DT115	-1990	B8HS	050809
DT75/85	1990-92	B8HS	050809	DT115	1992+	BR8HCS-10	050737
DT75/85	1993-00	BR8HS-10	050835	DT115C	1991-93	BR8HCS-10	050737
DT75C	2001+	BR8HS-10	050835	DT115C	-1990	B8HS	050809
DT75C	1993-00	B8HS	050809	DT115C	2001+	BR8HS-10	050835
DT75M	2001+	BR8HS-10	050835	DT115S	1996+	BR8HS-10	050835
DT75M	-2000	BR8HS	050854	DT115STC	1996+	BR8HS-10	050835
DT75TC	-2000	B8HS	050809	DT115TC	-1988	B8HS-10	050810
DT75TC	2001+	BR8HS-10	050835	DT115TC		BR8HCS-10	050737
DT85	-1992	BR8HS	050854	DT115TC(EFI)		BR8HS-10	050835
DT85C	2001+	BR8HS-10	050835	DT140	1992+	BR8HCS-10	050737
DT85C	1993-00	BR8HS	050854	DT1140	-1990	B8HS	050809
DT85C	-1992	BR8HS	050854	DT140EFI	1996+	BR8HS-10	050835
DT85M	2001+	BR8HS-10	050835	DT140C	1991-1996	BR8HCS-10	050737
DT85M	-2000	BR8HS	050854	DT1140C	-1990	B8HS	050809
DT85MQ	1995-96	B8HS-10	050810	DT140C EFI	1997+	BR8HCS-10	050737
DT85Q	2001+	BR8HS-10	050835	DT140T	-2000	BR8HCS-10	050737
DT85Q	-2000	BR8HS	050854	DT140T	2001+	BR8HS-10	050835
DT85TC	-2000	B8HS	050809	DT140TC	-2000	BR8HCS-10	050737
DT85TC	2001+	BR8HS-10	050835	DT140TC EFI		BR8HS-10	050835
DT85W	2001+	B8HS-10	050810	DT150	1987-02	BR8HS-10	050835
DT85W	-2000	BR8HS	050854	DT150G		BR8HS-10	050835
DT85WT	2001+	B8HS-10	050810	DT150S		BR8HS-10	050835
DT85WT	1995-96	B8HS-10	050810	DT150SS		BR8HS-10	050835
DT90	-2000	BR8HCS-10	050737	DT150STC		BR8HS-10	050835
DT90	2001+	BR8HS-10	050835	DT150TC	1989+	BR8HS-10	050835

SUZUKI

MOD. -HP	AÑO	Ref. NGK	Ref. PRONAUTIC
DT150TC EFI		BR8HS-10	050835
DT175	1989-02	BR8HS-10	050835
DT175TC	-1988	B8HS-10	050810
DT175TC	1989+	BR8HS-10	050835
DT200	1989-02	BR8HS-10	050835
DT200G		BR8HS-10	050835
DT200T		BR8HS-10	050835
DT200TC	1989+	BR8HS-10	050835
DT200V		BR8HS-10	050835
DT225	1991-02	BR8HS-10	050835
DT225TC		BR8HS-10	050835
DT225TCL EFI		BR8HS	050854
4 TIEMPOS			
DF4	2002+	BPR6ES	050826
DF5	2002+	BPR6ES	050826
DF6	2002+	BPR6ES	050826
DF9.9AEL	1995+	DCPR6E	050859
DF9.9AES	1995+	DCPR6E	050859
DF9.9AL	1995+	DCPR6E	050859
DF9.9AS	1995+	DCPR6E	050859
DF15AL	1995-99	DCPR6E	050859
DF15ARL	1995-99	DCPR6E	050859
DF15ARS	1995-99	DCPR6E	050859
DF15AS	1995-99	DCPR6E	050859
DF25	2000+	DCPR6E	050859
DF30	2000+	DCPR6E	050859
DF40	1999+	DCPR6E	050859
DF50	1999+	DCPR6E	050859
DF60	1998+	BPR6ES	050826
DF70	1998+	BPR6ES	050826
DF90	2001+	BPR6E	050738
DF115	2001+	BPR6E	050738
DF140	2002+	BPR6E	050738
DF200	2004+	BPR6E	050738
DF225	2004+	BPR6E	050738
DF250	2004+	BPR6E	050738

Modelo Descripción	HP	Trim & Tilt/ Sistema de arranque	Longitud eje	Tipo de mando	Año Modelo	Modelo especial Código Variac. (Usado motores 25 HP)
B = Inshore series C = Serie C CV = Serie C D = hélice doble rotación DX = hélice doble rotación OX66 EFI E = Serie enduro F = 4 tiempos LF = 4 tiempos mano izquierda L = Mano izquierda LX = Mano izquierda OX66 EFI LZ = Mano izquierda HPDI P = Serie Pro PX = Serie Pro OX66 EFI S = Serie Agua salada SX = Serie agua salada OX66 EFI T = Cuatro tiempos de alto voltaje V = Serie V max VX = V max OX66 EFI VZ = V max HPDI Z = Serie HPDI	Ejemplo: 6 9.9 200 250	T = tilt o trim/tilt (1984-1990) P = tilt con arranque eléctrico E = Arranque eléctrico (1984-1990) M = Tilt manual con Arranque manual	S = 15" L = 20" X = 25" U = 30"	R = Control Remoto H = Mando popero J = Jet	N = 1984 K = 1985 J = 1986 H = 1987 G = 1988 F = 1989 D = 1990 P = 1991 Q = 1992 R = 1993 S = 1994 T = 1995 U = 1996 V = 1997 W = 1998 X = 1999 Y = 2000 Z = 2001 A = 2002 B = 2003 C = 2004 D = 2005	2 = 3 Cil. 1997 3 = 3 Cil.

Desde abril de 2005 (2006 Modelo año) Yamaha no detalla el año de fabricación del motor al final de su referencia. Desde entonces los nuevos modelos tienen una letra entre el control/tilt Método.

Ejemplo:

VZ300TLRD = 2005

VZ300TLR = Nuevo modelo desde abril de 2005. VZ300BTLR = Modelos más nuevos.

EJEMPLO: SX150TLRY - Agua salada EFI, 150 HP, Trim & Tilt con arranque eléctrico, 20", Control remoto, modelo 2000

 <p>18-5130 CDI Reemplaza: 688-85540-16-00 Para: 90(1988-91), C75(1994-96), C85(1991-96), CV85(1989-90), E75(1995-96)</p>	 <p>18-5131 CDI Reemplaza: 695-85540-11, 695-85540-12-00 Para: 9.9(1984-95), 15(1984-95), C25(1992-97), CV25(1990)</p>	 <p>18-5132 CDI Reemplaza: 63V-85540-00-00, 63V-85540-01-00, 63V-85540-02-00 Para: 9.9(1999-09), 15(1999-09)</p>	 <p>18-23205 BOBINA DE ENCENDIDO Reemplaza: 65W-85570-01-00 Para: Yamaha F25(2005)</p>
 <p>18-23601 BOBINA ENCENDIDO Reemplaza: 66M-85570-00-00 Para: F9.9(2005-06), F15(1998-05), T9.9(2005-06)</p>	 <p>18-23602 BOBINA ENCENDIDO Reemplaza: 63V-85570-00-00 Para: 9.9(1996-09), 15(1996-09)</p>	 <p>18-5110 BOBINA ENCENDIDO Reemplaza: 6E5-85570-11-00 Para: 115 (4 cil.) 1985-91</p>	 <p>18-5111 BOBINA ENCENDIDO Reemplaza: 697-85570-11-00 Para: 55 (2 cil.) 1989-94 y 90 1984-88</p>
 <p>18-5112 BOBINA ENCENDIDO Reemplaza: 6E7-85570-19-00, 680-85570-09-00, 6E7-85570-10-00, 695-85570-10-00 Para: 9.9/15 (1988-93)</p>	 <p>18-5128 BOBINA ENCENDIDO Reemplaza: 6R3-85570-01-00 Para: 115/130/150HP (1994-04) 175HP (1994-95, 1997-98, 2000) 200HP (1994-98) 225HP (1997) B115HP 1998-99) C115HP (1997-98) últimos modelos V4 & V6</p>	 <p>18-5183 BOBINA, CARGA Reemplaza: 63V-85520-00, 63V-85520-01 Para: 9.9(1996-09), 15(1996-09)</p>	 <p>18-5195 BOBINA, ENCENDIDO Reemplaza: 689-81311-40-00 Para: 25(1984-87), 30(1984-86), C30(1991-92), C40(1994-97), CV30(1989-90), CV40(1990)</p>



18-25602
BOBINA, CARGA
 Reemplaza: 66M-85533-00-00
 Para: F9.9(2005-06), F15(1998-05)



18-5138
BOBINA, ENCENDIDO
 Reemplaza: 680-85570-00-00; 680-85570-02-00
 Para: T6 (02-05); F6, F8 (01-05); C25 (96-97)



18-5119
BOBINA, ENCENDIDO
 Reemplaza: 65E-85570-00-00



18-5113
BOBINA, ENCENDIDO
 Reemplaza: 61N-85570-00-00, 61N-85570-10-00
 Para: 25(1994-95, 2001-09)



18-25650
BOBINA, PULSADOR
 Reemplaza: 66M-85580-00-00
 Para: F9.9(2005-06), T9.9(2005-06), F15(1998-06)



18-25651
BOBINA, PULSADOR
 Reemplaza: 65W-85580-00-00
 Para: F25(1998-05), F30(2001-05), F40(2000-08), T25(2001-06)



18-25652
BOBINA, PULSADOR
 Reemplaza: 63V-85580-01-00
 Para: 9.9(2003-09), 15(2003-09)



18-25604
BOBINA LUZ
 Reemplaza: 63V-85533-00-00
 Para: 9.9(1996-09), 15(1996-09)



18-25600
BOBINA, CARGA
 Reemplaza: 66M-85520-00-00
 Para: F9.9(2005-06), T9.9(2005-06), F15(1998-06)



18-5135
CDI
 Reemplaza: 6E5-85540-10-00, 6E5-85540-11-00, 6E5-85540-12-00
 Para: 115 ET 1984-1989; 130 ET 1988-1989; C115TLR 1991-1996; C115TXR 1992-1996; L130ETX 1989; 1989 2-225HP



18-5136
CDI
 Reemplaza: 6F5-85540-21-00, 6F5-85540-22-00
 Para: 40HP 2 Cilindro (Int'l)



18-25300
CAJA CDI
 Reemplaza: 66M-85540-01-00
 Para: F9.9(2005-06), F15(2000-06)



18-25605
BOBINA DE CARGA
Reemplaza: 65W-85510-10-00
Para: F25(1999-05), F30(2001), F40(2000-01)



MP39160
INTERRUPTOR PULSADOR MOMENTANEO
Para instalaciones fueraborda.



MP51020 (LLAVE)
MP51022 (CAJA DE 100 PCS)
LLAVE ENCENDIDO
Reemplaza: 703-82510-12-00
Caja de control Yamaha 2 & 4 T
Mismos colores del cableado que el original



MP51030 (LLAVE)
MP51032 (CAJA DE 100 PCS)
LLAVE ENCENDIDO
Reemplaza: 61B-82510-01-00, 61B-82510-00-00
Yamaha montaje salpicadero 2 T
Aplicación motores dobles...



MP51040 (LLAVE)
MP51042 (CAJA DE 100 PCS/CTN)
LLAVE ENCENDIDO
Reemplaza: 703-82510-43-00
Caja control Yamaha 2 & 4 T
Pulsar para el starter
Mismos colores del cableado que el original



MP51050 (LLAVE)
MP51052 (CAJA DE 100 PCS)
LLAVE ENCENDIDO
Reemplaza: 6K1-82510-06-00
Yamaha montaje salpicadero 2 & 4 T
Aplicación montaje doble, Pulsar=starter
Mismos colores que el cableado original



MP28860
HOMBRE AL AGUA
Reemplaza: 682-82556-00-00



18-65450
INTERRUPTOR PARADA MOTOR
Reemplaza: 6E9-82575-02-00
Para: Yamaha 6(1995-00), 8(1995-09), 9.9(1994-95), C30(1994-96), C40(1994-97)



18-5225
KIT CABLES DE BUJÍAS
Kit incluye un rollo de 7,5mts. de cable encendido de Hypalon de 7mm. con alma metálica y un surtido de 3 tipos de terminales para motores fueraborda.



18-5226
CABLE ENCENDIDO
Alma metálica
100' Bobina
7mm Hypalon



18-5750
18-5750-9①
TAPA DE BUJÍAS UNIVERSAL
Reemplaza: OMC 581027, 580339
Con terminal conector



18-5752
TAPA DE BUJÍAS UNIVERSAL
8mm



18-5224
18-5224-9①
TERMINAL CABLE BUJÍAS
Reemplaza: Mercury 20121
OMC 510364

① Precio por pack

TABLA APLICACIÓN ENCENDIDO YAMAHA FUERABORDA

HP	Año Inicio	Año final	CDI	Bobina encendido	Bobina de carga (Stator)	Bobina de impulso	Bobina iluminación
9.9	1984	1995	18-5131	18-5111	-	-	-
9.9	1996	1998	-	18-23602	18-5183	18-25652	18-25604
9.9	1999	2009	18-5132	18-23602	18-5183	18-25652	18-25604
15	1984	1995	18-5131	18-5112	-	-	-
15	1996	1998	-	18-23602	18-5183	18-25652	18-25604
15	1999	2009	18-5132	-	18-5183	18-25652	18-25604
20	1996	1997	-	18-5113	-	-	-
25	1984	1987	-	-	18-5195	-	-

APLICACIÓN CONTINUA EN LA SIGUIENTE PÁGINA

TABLA APLICACIÓN ENCENDIDO YAMAHA FUERABORDA

HP	Año Inicio	Año final	CDI	Bobina encendido	Bobina de carga (Stator)	Bobina de impulso	Bobina iluminación
25	1994	2009	-	18-5113	-	-	-
30	1984	1986	-	-	18-5195	-	-
90	1984	1988	-	18-5111	-	-	-
90	1988	1991	18-5130	-	-	-	-
115	1984	1989	18-5135	18-5110	-	-	-
115	1994	2009	-	18-5128	-	-	-
130	1988	1989	18-5135	18-5110	-	-	-
130	1994	2004	-	18-5112	-	-	-
150	1984	1989	-	18-5110	-	-	-
150	1994	2009	-	18-5112	-	-	-
175	1984	1989	-	18-5110	-	-	-
175	1994	1995	-	18-5112	-	-	-
175	2000	2000	-	18-5112	-	-	-
200	1984	1989	-	18-5110	-	-	-
200	1994	1998	-	18-5112	-	-	-
225	1994	1997	-	18-5112	-	-	-
B115	1998	1999	-	18-5112	-	-	-
C25	1992	1995	18-5131	18-5112	-	-	-
C25	1996	1997	18-5131	18-5138	-	-	-
C30	1991	1992	-	-	18-5195	-	-
C30	1993	1997	-	18-5113	-	-	-
C40	1991	1997	-	-	18-5195	-	-
C55	1991	1994	-	18-5111	-	-	-
C75	1994	1996	18-5130	-	-	-	-
C85	1991	1996	18-5130	-	-	-	-
C115	1991	1996	18-5135	18-5110	-	-	-
C115	1997	2000	-	18-5112	-	-	-
C150	1996	1999	-	18-5112	-	-	-
CV25	1990	1990	18-5131	18-5112	-	-	-
CV30	1989	1990	-	-	18-5195	-	-
CV40	1990	1990	-	-	18-5195	-	-
CV55	1989	1990	-	18-5111	-	-	-
CV85	1989	1990	18-5130	-	-	-	-
D150	1997	1999	-	18-5112	-	-	-
E48	1995	1996	-	18-5112	-	-	-
E75	1995	1996	18-5130	-	-	-	-
F6	2001	2008	-	18-5138	-	-	-
F8	2001	2015	-	18-5138	-	-	-
F9.9	2005	2006	18-25300	18-23601	18-25600	18-25650	-
F9.9	2007	2014	-	18-5138	-	-	-
F15	1998	1999	-	18-23601	18-25600	18-25650	-
F15	2000	2005	18-25300	18-23601	18-25600	18-25650	-
F25	1998	2004	-	18-23205	18-25605	18-25651	-
F25	2005	2005	-	18-23205	18-25605	18-25651	-
F30	2001	2005	-	-	18-25605	18-25651	-
F40	2000	2008	-	-	18-25605	18-25651	-
L130	1989	1989	18-5135	18-5110	-	-	-
L130	1994	2001	-	18-5112	-	-	-
L150	1986	1989	-	18-5110	-	-	-
L150	1994	1999	-	18-5112	-	-	-
L200	1986	1989	-	18-5110	-	-	-
L200	1994	1999	-	18-5112	-	-	-
P115	1994	1996	-	18-5112	-	-	-
P150	1994	1999	-	18-5112	-	-	-
P175	1994	1999	-	18-5112	-	-	-

APLICACIONES CONTINUAN EN LA SIGUIENTE PAGINA

TABLA APLICACIÓN ENCENDIDO YAMAHA FUERABORDA

HP	Año Inicio	Año final	CDI	Bobina encendido	Bobina de carga (Stator)	Bobina de impulso	Bobina iluminación
P200	1994	1999	-	18-5112	-	-	-
PROV150	1986	1989	-	18-5110	-	-	-
S115	1996	1999	-	18-5112	-	-	-
S130	1996	1999	-	18-5112	-	-	-
S150	1996	1999	-	18-5112	-	-	-
S175	1996	1999	-	18-5112	-	-	-
S200	1996	1999	-	18-5112	-	-	-
T8	2001	2010	-	18-5138	-	-	-
T9.9	2005	2006	18-25300	18-23601	18-25600	18-25650	-
T9.9	2007	2014	-	18-5138	-	-	-
T25	2001	2004	-	-	18-25605	18-25651	-
T25	2005	2005	-	18-23205	18-25605	-	-
T25	2006	2006	-	-	18-25605	18-25651	-
V150	2000	2008	-	18-5112	-	-	-
V175	2000	2000	-	18-5112	-	-	-
V6EXCEL	1987	1989	-	18-5110	-	-	-
V6SPECIAL	1984	1986	-	18-5110	-	-	-

 <p>18-5819 SOLENOIDE Reemplaza: 65W-81941-00-00 Para: F25 (1998-04), F30 (2001-04), F40 (2000-04)</p>	 <p>18-5853 SOLENOIDE Reemplaza: 61A-81941-00-00, 6E5-81941-11-00, 6E5-81941-10-00, 6E5-81941-00-00 Para: 2-tiempos: 115hp - 150hp. (1994-Actual); 175hp (1994-2000); 200hp (1994-2005); 225hp. (1995-2004); 250hp (1990-2004)</p>	 <p>18-5821 MOTOR ARRANQUE SOLENOIDE Reemplaza: 6G1-81941-10-00 Para: 9.9/15(1988-97), 20(1996-97), 25(1985, 1988-99), 30(1985-87, 1989-93, 1996-99, 2001), 40(1989-90, 1992-01), 50(1989-97, 1999-02), 1990(1992-02), F15(1998-03), F40(1999), F50(1996-02), F60(2002-03), F75(2003-04), F80(1999-03), F90(2003-04), F100(1999-02)</p>
 <p>18-5879 SOLENOIDE Reemplaza: 688-81950-10-00, 688-81941-00-00 Para: 2-tiempos: 40hp (1984-88); 50hp (1984-88); 60hp. (2001-06); 70hp. (1991-Actual); 90hp. (1984-91)</p>	 <p>18-5746 ENSAMBLAJE STATOR Reemplaza: 6H3-85510-A0, 6H3-85510-A1 Para: E60(1995-99), P60(1991), 70(1984-91)</p>	 <p>18-17300 ENSAMBLAJE RECTIFICADOR Reemplaza: 65W-81960-10-00 Para: F25(2004 & Sup), F40(2004 & Sup)</p>
 <p>18-17301 RECTIFICADOR REGULA- DOR Reemplaza: 6J8-81960-00-00 Para: 25(1997-02), 30(1997-02)</p>	 <p>18-6410 MOTOR ARRANQUE FUERABORDA Reemplaza: Yamaha 689-81800-13-00, 689-81800-11, 689-81800-12 Para: 25-40HP (11 dientes)</p>	 <p>18-6411 MOTOR ARRANQUE FUERABORDA Reemplaza: 6H3-81800-11-00, 6H3-81800-10 Para: 60HP</p>



18-6412
MOTOR ARRANQUE FUERABORDA
 Reemplaza: 697-81800-12, 99999-03249-00
 Para: 55-60HP 2 cilindros (9 dientes)



18-6413
MOTOR ARRANQUE FUERABORDA
 Reemplaza: 6E5-81800-11-00,
 6E5-81800-12-00
 Para: 55-60HP 2 cilindros (9 dientes)



18-6415
MOTOR ARRANQUE FUERABORDA
 Reemplaza: 6N7-81800-10-00
 Para: 115-250HP (9 dientes)



18-6420
MOTOR ARRANQUE FUERABORDA
 Reemplaza: 6L2-81800-20-00
 Para: 20HP MLHU & MSHU (1996),
 20HP MLHV & MSHV 1997 25 (1988-98)



18-6421
MOTOR ARRANQUE FUERABORDA
 Reemplaza: 6F5-81800-11, 6J4-81800-01-00
 Para: 25HP (1998&2001), 30HP (1996-99 & 2001),
 40HP (1992-03) C40 1997-02, P40 (1998)
 50 (1992-97 & 2000 & 2002-03) C50 (1998-01), P50 (1993-96)



18-6422
MOTOR ARRANQUE FUERABORDA
 Reemplaza: 6H4-81800-12-00
 Para: 40HP (1984-86), 50HP (1986-88), Pro 50
 (1987-88)



18-6423
MOTOR ARRANQUE FUERABORDA
 Reemplaza: 688-81800-12-00
 Para: C75 (1994-96), (1998-99), P75 (1996-99),
 C80 TLRV (1997), C85 (1991-96)
 CV85 (1990), 90 (1984-03), B90 (1998-99) C90 (1997-01)



18-6425
MOTOR ARRANQUE FUERABORDA
 Reemplaza: 67F-81800-02-00
 Para: F75 (2003), F80 (2001-02), F90 (2003), F100
 (2001-02)



18-6426
MOTOR ARRANQUE FUERABORDA
 Reemplaza: 68F-81800-01-00
 Para: LZ150(00-05), LZ200(00-11), VZ150(00-11),
 VZ175(01-11), VZ200(01-04), Z150(00-05), Z175(01-
 05), Z200(00-11)



18-6427
MOTOR ARRANQUE FUERABORDA
 Reemplaza: 68V-81800-01-00
 Para: F115 2001-03



18-6832
MOTOR ARRANQUE
 Reemplaza: 60V-81800-00-00,
 60X-81800-00-00
 Para: 250HP 2003-04



18-6833
MOTOR ARRANQUE
 Reemplaza: 69J-81800-00-00
 Para: 2002-2004 200-225HP



18-6861
MOTOR ARRANQUE
 Reemplaza: Yamaha 61A-81800-01-00,
 61H-81800-01-00, 69L-81800-00-00
 Hitachi S114-559B
 Para: Motores Yamaha 200-250HP



18-6942
MOTOR ARRANQUE
 Reemplaza: Yamaha 69W-81800-00-00
 Hitachi S114-682
 Para: 2002-04 60HP, 2003-04 50HP



18-6943
MOTOR ARRANQUE
 Reemplaza: 66M-81800-01-00, 02-00
 Para: Motores 9.9-15HP



18-6961
MOTOR DE ARRANQUE
Reemplaza: 6CB-81800-00-00
Para: 200, 225, 250 4 Ciclo (2006 & Sup)



18-50000
MANETA
Reemplaza: 689-5755-01-00, 6G1-15779-00-00
Para: Yamaha 15 hp & sup (1988 & sup)



18-50001
MANETA
Reemplaza: 6G1-15755-00-00, 6G1-15779-00-00
Para: 2.5-9.9 hp(1988 & Sup)



18-56002
ALOJAMIENTO ESCOBILLAS
Reemplaza: 689-81840-11-00
Para: F6/F8/T8 (2001-05), F9.9 (1985-90,1999-05), T9.9 (1991-97,1999,2001-05), 25 (1984-87)(1999-00), C25 (1991,1993-97), CV25 (1990), 30 (1984-01), C30 (1991-97), CV30 (1990), 40 (1984-05), P40 (1998), C40 (1991-01), CV40 (1990), 50 (1986-05), C50 (1998-01), P50 (1991-96), PRO50 (1987-90), 60 (2001-05), C60 (1996-01), P60 (1991-99), 70 (1984-05), C70 (2000-01)
Use con **18-6410** motor de arranque



18-56004
ALOJAMIENTO ESCOBILLAS
Reemplaza: 663-81840-11-00
Para motores de arranque: 689-81800-13-00(18-6410), 6H3-81800-11-00 (18-6410), 6F5-81800-11-00,6J4-81800-01-00 (18-6421) 6H4-81800-12-00 (18-6422), 697-81800-12, 99999-03249-00-00 (18-6412)



18-56005
ALOJAMIENTO ESCOBILLAS
Reemplaza: 6E5-81840-10-00
Para motores de arranque: 689-81800-13-00(18-6410), 6H3-81800-11-00 (18-6410), 6F5-81800-11-00, 6J481800-01-00(18-6421), 6H4-81800-12-00 (18-6422), 6E5-81800-11-00, 6E5-81800-12-00 (18-6413)



18-56006
ALOJAMIENTO ESCOBILLAS
Reemplaza: 6N7-81840-00-00
Para: 115,130,150 HP (1997-04), 175,200 HP (1997-98), 225 HP (1997)
Use con **18-6415** Motor de arranque



18-56007
ALOJAMIENTO ESCOBILLAS
Reemplaza: 61A-81840-00-00
Para motor de arranque: 61A-81800-00-00, 61A-81800-01-00, 69L-81800-00-00
Para:225 (1991-96), 250 (1990-95), L225 (1994-99), L250 (1990-99), LX225,LX250 (2000-03), P150,P175 (1994-96, P200 1991-96, S225/S250 1996-99), SX225,SX250 (2000-03), V200/V225 (1998-99), VX200 (2000-05), VX225 (2000-04), VX250 (2002-04)



18-6798
MOTOR TRIM
Reemplaza: 69J-43880-00-00, 60V-43880-00-00
(Aro incluido)
Para: F200, F225 (2004-06), F250 (2005-06), LF200, LF225, LF250, LZ200, LZ225, LZ250 (2004-06)



18-6748
MOTOR TRIM
Reemplaza: 67C-43880-00-00
Para: F30, F40 (2001 & Sup)

HP	Tiemp.	Modelo	Año	Motor de arranque	HP	Tiemp.	Modelo	Año	Motor de arranque
9.9		9.9	1984-1997	18-6420	15		F15ELHA - F15ELHD	2002-2005	18-6943
9.9	4	F9.9ELR2	2006 & SUP	18-6943	15	4	F15ELHK	2006 & SUP	18-6943
9.9		F9.9ELR2D	2005	18-6943	15		F15ELHY - F15ELHZ	2000-2001	18-6943
9.9	4	F9.9MLH2	2006 & SUP	18-6943	15	4	F15ESH	2006 & SUP	18-6943
9.9		F9.9MLH2D	2005	18-6943	15		F15ESHA - F15ESHD	2002-2005	18-6943
9.9	4	F9.9MSH2D	2006 & SUP	18-6943	15	4	F15ESHK	2006 & SUP	18-6943
9.9		F9.9MSH2D	2005	18-6943	15		F15ESHY - F15ESHZ	2000-2001	18-6943
9.9	4	T9.9ELH2	2006 & SUP	18-6943	15	4	F15MLH	2006 & SUP	18-6943
9.9		T9.9ELH2D	2005	18-6943	15		F15MLHA - F15MLHD	2002-2005	18-6943
9.9	4	T9.9ELR2 - T9.9EXH2	2006 & SUP	18-6943	15	4	F15MLHK	2006 & SUP	18-6943
9.9		T9.9EXH2D	2005	18-6943	15		F15MLHY - F15MLHZ	2000-2001	18-6943
15		15	1984-1997	18-6420	15	4	F15MSH	2006 & SUP	18-6943
15	4	F15ELH	2006 & SUP	18-6943	15		F15MSHA - F15MSHD	2002-2005	18-6943

APLICACIÓN CONTINUA EN LA SIGUIENTE PÁGINA

HP	Temp.	Modelo	Año	Motor de arranque	HP	Temp.	Modelo	Año	Motor de arranque
15	4	F15MSHK	2006 & SUP	18-6943	60		P60	1991-1999	18-6411
15		F15MSHY - F15MSHZ	2000-2001	18-6943	60		P60TLHP - P60TLHX	1991-1999	18-6411
15	4	F15PLH	2006 & UP	18-6943	70		70	1984-2009	18-6411
15		F15PLHA - F15PLHD	2002-2005	18-6943	70		70ETLD - 70ETLN	1984-1990	18-6411
15	4	F15PLHK	2006 & SUP	18-6943	70	2	70TLR	2006 & SUP	18-6411
15		F15PLHZ	2001	18-6943	70		70ETLN - 70TRP	1984-2005	18-6411
15	4	F15PLR	2006 & SUP	18-6943	70		C70	2000-2001	18-6411
15		F15PLRA - F15PLRD	2002-2005	18-6943	70		C70TLRY - C70TLRZ	2000-2001	18-6411
15	4	F15PLRK	2006 & SUP	18-6943	75		C75	1994-1999	18-6423
15		F15PLRZ	2001	18-6943	75		C75TLRS - C75TLRX	1994-1999	18-6423
25		25 (2 CIL)	1984-1987	18-6410	75		F75	2003-2004	18-6425
25		25 (2 CIL)	1988-2009	18-6420	75		F75	2005-2011	18-6427
25		C25	1991-1997	18-6410	75		F75TLRB - F75TLRD	2003-2005	18-6425
25		CV25	1990	18-6410	75		F75TLRD	2005	18-6427
25	2	25ELH	2006 & SUP	18-6420	75		P75	1996-1999	18-6423
25		25ELH - 25ELN	1984-1987	18-6410	75		P75TLHU - P75TLHX	1996-1999	18-6423
25	2	25ELR	2006 & SUP	18-6420	80		C80	1997	18-6423
25	2	25ESH	2006 & SUP	18-6420	80		C80TLRV	1997	18-6423
25		25ESH - 25ESN	1984-1987	18-6410	80		F80	1999-2003	18-6425
25	2	25ESR	2006 & SUP	18-6420	80		F80TJRA - F80TLRZ	2001-2003	18-6425
25		25LH - 25LN	1984-1987	18-6410	85		C85	1991-1996	18-6423
25	2	25MLH	2006 & SUP	18-6420	85		C85ELD - C85TLRU	1990-1996	18-6410
25		25MLHX3	1999	18-6421	85		CV85	1989-1990	18-6423
25	2	25MSH	2006 & SUP	18-6420	85		CV85ELF	1989	18-6410
25		25MSHX3 - 25MSHZ3	1999-2001	18-6421	90		90	1984-2009	18-6423
25		25SH - 25SN	1984-1987	18-6410	90		90ETLD - 90TJRZ	1984-2001	18-6410
25		C25ELD - C25HSHV	1990-1997	18-6410	90	2	90TLR	2006 & SUP	18-6410
30		30	1984-1986	18-6410	90		90TLRA - 90TLRZ	1991-2005	18-6410
30		30	1987-2001	18-6421	90		B90	1997-1999	18-6423
30		30ELHT - 30ELHY	1995-2001	18-6421	90		B90TLRV - B90TLRX	1997-1999	18-6410
30		30ELJ - 30ELN	1984-1986	18-6410	90		C90	1997-2001	18-6423
30		30ELRT - 30ELRZ	1995-2001	18-6421	90		C90TLRV - C90TLRZ	1997-2001	18-6410
30		30ESJ - 30ESN	1984-1986	18-6410	90		F90	2003-2004	18-6425
30		30ESRT - 30MSHZ	1995-2001	18-6421	90		F90	2006-2011	18-6427
30		C30	1991-1997	18-6410	90	4	F90TJR	2006 & UP	18-6427
30		C30ELD - C30MLHS	1990-1997	18-6410	90		F90TJRB - F90TJRC	2003-2004	18-6425
30		CV30	1989-1990	18-6410	90	4	F90TLR	2006 & SUP	18-6427
30		CV30ELF	1989	18-6410	90		F90TLRB - F90TLRC	2003-2004	18-6425
40		40	1984-1988	18-6422	90	4	F90TXR	2006 & SUP	18-6427
40		40	1989-2005	18-6421	100		F100	1999-2003	18-6425
40		40EJRQ	1992	18-6421	100		F100TLRA - F100TXRZ	2001-2003	18-6425
40		40EJRR - 40TLHV	1993-2001	18-6421	115		115	1984-1996	18-6413
40	2	40TLR	2006 & SUP	18-6421	115		115	2000-2009	18-6415
40		40TLRA - 40TLRZ	1994-2005	18-6421	115		115ETLD	1990	18-6413
40		C40	1991-1997	18-6410	115		115ETLD-JD	1990	18-6413
40		C40ELRP	1991	18-6410	115		115ETLF	1989	18-6413
40		C40ELRQ - C40TLRZ	1992-2001	18-6410	115		115ETLF-JD	1989	18-6413
40		CV40ELD	1990	18-6410	115		115ETLG	1988	18-6413
40		F40TLRX	1999	18-6413	115		115ETLG-JD	1988	18-6413
40		P40	1998	18-6421	115		115ETLH	1987	18-6413
40		P40TLHW - P40TLRW	1998	18-6421	115		115ETLH-JD	1987	18-6413
50		50	1984-1988	18-6422	115		115ETLJ - 115TXRT	1984-1996	18-6413
50		50	1989-2009	18-6421	115		C115	1991-1996	18-6413
50		50EJRQ - 50TLHV	1992-2001	18-6421	115		C115	2000	18-6415
50	2	50TLR	2006 & SUP	18-6421	115		C115LXRQ - C115TXRU	1991-1996	18-6413
50		50TLRA - 50TLRZ	1996-2005	18-6421	115		F115	2000-2011	18-6427
50		C50	1998-2001	18-6421	115	4	F115TJR	2006 & SUP	18-6427
50		C50TLRW - C50TLRZ	1998-2001	18-6421	115		F115TJRA - F115TJRD	2002-2005	18-6427
50		F50	1995-2002	18-6413	115	4	F115TLR	2006 & UP	18-6427
50		F50TJRA - F50TLRZ	1995-2002	18-6413	115		F115TLRA - F115TLRZ	2001-2005	18-6427
50		P50	1991-1996	18-6421	115	4	F115TXR	2006 & SUP	18-6427
50		P50TLRR - P50TLRU	1993-1996	18-6413	115		F115TXRA - F115TXRZ	2001-2005	18-6427
50		T50	1996-2002	18-6413	115		LF115	2000-2011	18-6427
50		T50TLRA - T50TLRY	1996-2002	18-6413	115	4	LF115TXR	2006 & SUP	18-6427
55		C55	1991-1995	18-6412	115		LF115TXRA - LF115TXRD	2002-2005	18-6427
55		CV55	1989-1990	18-6412	115		P115	1993-1996	18-6413
60		60	2001-2005	18-6411	115		P115TLRR - S115TLRU	1993-1996	18-6413
60	2	60TLR	2006 & SUP	18-6411	130		130	1988-1996	18-6413
60		60TLRA - 60TLRZ	2001-2005	18-6411	130		130	2000-2004	18-6415
60		C60	1996-2001	18-6411	130		130ETLD - 130TXRT	1988-1995	18-6413
60		C60ELRU - C60TLRZ	1996-2001	18-6411	130		L130	1989-1996	18-6413

APLICACIONES CONTINUAN EN LA SIGUIENTE PÁG.

HP	Tiemp.	Modelo	Año	Motor de arranque	HP	Tiemp.	Modelo	Año	Motor de arranque
130		L130	2000-2001	18-6415	200	2	LZ200TXR	2006 & SUP	18-6426
130		L130ETXD - S130TXRU	1990-1996	18-6413	200		LZ200TXRA - LZ200TXRZ	2000-2005	18-6426
150		150	1984-1996	18-6413	200		P200TLRS - P200TLRU	1994-1996	18-6413
150		150	2000-2009	18-6415	200		S200	1996	18-6413
150		150ETLD - 150TXRT	1990-1997	18-6413	200		S200TXRU	1996	18-6413
150		C150	1996	18-6413	200		SX200	1999-2005	18-6415
150		C150TLRU	1996	18-6413	200		V-200	1998-1999	18-6424
150		C150TXRU	1996	18-6413	200		V200TLRW - V200TLRX	1998-1999	18-6861
150		DX150	1999-2005	18-6415	200		VX200	2000-2003	18-6424
150		L150	1986-1996	18-6413	200		VX200TLRA - VX200TLRZ	2001-2003	18-6861
150		L150ETXD - L150TXRU	1986-1996	18-6413	200		VZ200	2001-2004	18-6426
150	4	LF150TXR	2006 & SUP	18-6413	200		VZ200TLRA - VZ200TLRZ	2001-2004	18-6426
150		LX150	1999-2001	18-6415	200		Z200	2000-2011	18-6426
150		LZ150	2000-2005	18-6426	200	2	Z200TLR	2006 & SUP	18-6426
150	2	LZ150TXR	2006 & SUP	18-6426	200		Z200TLRD	2005	18-6426
150		LZ150TXRA - LZ150TXRZ	2000-2005	18-6426	200		Z200TLRY - Z200TLRZ	2000-2001	18-6426
150		Z150	2000-2005	18-6415	200	2	Z200TXR	2006 & SUP	18-6426
150		P150	1991-1996	18-6413	200		Z200TXRA - Z200TXRZ	2000-2005	18-6426
150		P150TLRQ - P150TLRU	1986-1996	18-6413	225		225TUR	1995	18-6861
150		PRO V-150	1986-1990	18-6413	225		225TXRS	1994	18-6861
150		S150	1996	18-6413	225		225TXRT	1995	18-6861
150		S150TLRU / S150TXRU	1996	18-6413	225	4	F225TUR	2006 & SUP	18-6833
150		SX150	2000-2001	18-6415	225		F225TURA - F225TURD	2002-2005	18-6833
150		V-150	2000-2008	18-6415	225	4	F225TXR	2006 & SUP	18-6833
150		VX150	2000-2004	18-6415	225		F225TXRA - F225TXRD	2002-2005	18-6833
150		VZ150	2000-2011	18-6426	225		L225	1994-1999	18-6424
150	2	VZ150TLR	2006 & SUP	18-6426	225		L225TUR - L225TXRX	1994-1999	18-6861
150		VZ150TLRA - Z150TLRZ	2000-2004	18-6426	225	4	LF225TUR	2006 & SUP	18-6833
150	2	Z150TXR	2006 & SUP	18-6426	225		LF225TURA - LF225TURD	2002-2005	18-6833
150		Z150TXRA - Z150TXRZ	2000-2004	18-6426	225	4	LF225TXR	2006 & SUP	18-6833
175		175	1984-1995	18-6413	225		LF225TXRA - LF225TXRD	2002-2005	18-6833
175		175	2000	18-6415	225		LX225	2000-2003	18-6424
175		175ETLD - 175TXRT	1984-1995	18-6413	225		LX225TXRA - LX225TXRZ	2000-2003	18-6861
175		P175	1994-1996	18-6413	225		S225	1996-1999	18-6424
175		P175TLRS - P175TLRU	1994-1996	18-6413	225		S225TURU - S225TXRX	1996-1999	18-6861
175		S175 / S175TXRU	1996	18-6413	225		SX225	2000-2003	18-6424
175		V-175	2000	18-6415	225		SX225TURA - SX225TXRZ	2000-2003	18-6861
175		VZ175	2001-2011	18-6426	225		V225	1998-1999	18-6424
175	2	VZ175TLR	2006 & SUP	18-6426	225		V225TLRW - V225TLRX	1998-1999	18-6861
175		VZ175TLRA - VZ175TLRZ	2001-2005	18-6426	225		VX225	2000-2003	18-6424
175		Z175	2001-2005	18-6426	225		VX225TLRA - VX225TLRZ	2000-2003	18-6861
175	2	Z175TXR	2006 & SUP	18-6426	250		250	1990-1995	18-6424
175		Z175TXRA - Z175TXRZ	2001-2005	18-6426	250		250ETXD - 250TXRT	1990-1995	18-6861
200		200	1984-1996	18-6413	250		L250	1990-1999	18-6424
200		200ETLD - 200TXRT	1984-1996	18-6413	250		L250ETXD - L250TXRX	1990-1999	18-6861
200	4	F200TXR	2006 & SUP	18-6833	250		LX250	2000-2003	18-6424
200		F200TXRA - F200TXRD	2002-2005	18-6833	250		LX250TURA - LX250TXRZ	2000-2003	18-6861
200	4	F200XTR	2006 & SUP	18-6833	250		S250	1996-1999	18-6424
200		L200	1986-1996	18-6413	250		S250TURU - S250TXRX	1996-1999	18-6861
200		L200ETF - L200TXRU	1986-1996	18-6413	250		SX250	2000-2003	18-6424
200	4	LF200TXR	2006 & SUP	18-6833	250		SX250TURA - SX250TXRZ	2000-2003	18-6861
200		LF200TXRA - LF200TXRD	2002-2005	18-6833			V-6 SPECIAL	1984-1986	18-6413
200		LX200	1999-2001	18-6415			V-6 SPECIAL L	1984	18-6413
200		LZ200	2002-2011	18-6426			V-6SPECIAL X	1984	18-6413





18-6259
MOTOR TILT/TRIM
 Reemplaza: 6H1-43880-00-00
 (Incluye Aro)
 Para: 70/90HP (1987-91), C85/P60HP (1991)



18-6787
MOTOR TILT/TRIM
 Reemplaza: 67F-43880-00-00
 (Incluye Aro)
 Para: Yamaha 4-Tiempos F75 (2003-04), F80 (1999-03), F90 (2003-04), F100 (1999-02)



18-6788
MOTOR TILT/TRIM
 Reemplaza: 6H5-43880-02-00
 (Incluye Aro)
 Para: Yamaha 40-50hp (1985-92)



18-6789
MOTOR TILT/TRIM
 Reemplaza: 62X-43880-09-00
 (Incluye Aro)
 Para: Yamaha 40-100hp (1995-03)



18-6760
MOTOR TRIM
 Reemplaza: 6G5-43880-02-00
 (Incluye Aro)
 Para: 115-200HP (1987-96)



18-6781
MOTOR TILT/TRIM
 Reemplaza: 6HI-43880-02-00
 2-cables de conexión, 3 tornillos
 Para: 40HP (1994) 50HP (1992-95) 60HP (1997-sup)
 70HP (1996-sup) 90HP (1992-sup)



18-6782
MOTOR TILT/TRIM
 Reemplaza: 61A-43880-01-00,
 61A-43880-02-00
 3-tornillos, 4 cables conexión
 (Incluye Aro)
 Para: 225-250HP



18-6783
MOTOR TILT/TRIM
 Reemplaza: 64E-43880-00-00, 64E-43880-01-00
 2-cable 4-tornillos
 (Incluye Aro)
 Para: 115-225HP (1997-2002)



18-6811
MOTOR POWER TRIM
 Reemplaza: 62Y-43880-00-00, 62Y-43880-00-00,
 69W-43880-00-00
 (Incluye Aro)
 Para: 40(2003 & sup), 50(2003 & sup), C40(2003),
 F50(2003-04), T50(2003-04), 2002-04 60hp 4-tiempos



18-6812
MOTOR TRIM
 Reemplaza: 62X-43880-00-00,
 62X-43880-01-00, 62X-43880-09-00
 Para: 1995-03 Yamaha 40-100HP



18-6821
MOTOR TRIM
 Reemplaza: 688-43880-11-00,
 6E5-43880-01-00, -02-00
 Para: Yamaha 50-200HP 1985-86



18-6836
MOTOR TRIM
 Reemplaza: 6C5-43880-00-00
 Para: 2005-06 F50 y F60



18-6865
COMPLETE TRIM ASSEMBLY
 Reemplaza: Yamaha
 Para: trim completo, 115-225HP Johnson/Evinrude



18-6823
CABLEADO
 Convierte de 3 a 2 cables



18-7484
ARO
 Reemplaza: 65W-43871-00-00
 Para: F25-F40 1999-2008 con Power Trim



18-2083
RETEN INYECTOR COMB.
 Reemplaza: 68V-13766-00-00



18-2081
 Reemplaza: 64E-43822-00-00
18-2082
 Reemplaza: 64E-4384J-00-00



18-9802
LUZ PUESTA A PUNTO
Hasta 10,000 RPM's



18-7058
KIT CARBURADOR
Reemplaza: 61N-14392-00-00,
6L2-14392-00-00, 63V-W0093-00-00
Para: 9.9(1996-09), 15(1996-09)



18-7059
KIT CARBURADOR
Reemplaza: 677-W0093-00-00,
677-W0093-04-00
Para: 9.9(1984-85), 15(1984-85)

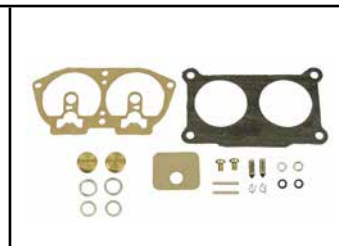

18-7002
KIT CARBURADOR
Reemplaza: 6E5-W0093-06-00
Para: 115 (1986-88,1992-93, 1995), 130
(1988,1992-93, 1995), 150, 175 (1986-
87, 1992-95), 200 (1986-87,1992-95),
225 (1992-93)

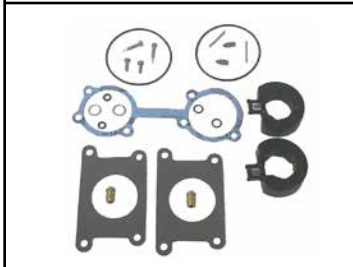

18-7290*
KIT CARBURADOR
Reemplaza: 696-W0093-02-00
*kit contiene componentes suficientes
para reconstruir 2 carburadores



18-7291
KIT CARBURADOR
Reemplaza: 6H1-W0093-01-00
(3) de 18-7291 = (1) de 6H1-W0093-01-00



18-7293
KIT CARBURADOR
Reemplaza: 6A1-W0093-01-00



18-7736
KIT CARBURADOR
Reemplaza: 67D-W0093-00-00
Para: (1999-02) F4



18-7737
KIT CARBURADOR
Reemplaza: 61N-W0093-00-00
Para: (1993-97) C30



18-7738
KIT CARBURADOR
Reemplaza: 66M-W0093-01-00,
66M-W0093-00-00
Para: (1998-02) F15



18-7739
KIT CARBURADOR
Reemplaza: 6L2-W0093-00-00
Para: (1996-97) 20 (1988-02) 25 3 cil



18-7740
KIT CARBURADOR
Reemplaza: 6E9-W0093-02-00
Para: (1990-94) C40 2 cil



18-7741
KIT CARBURADOR
Reemplaza: 6E9-W0093-03-00
Para: (1995-98) C40 2 cil



18-7742
KIT CARBURADOR
Reemplaza: 6H0-W0093-00-00
Para: (1997) C80



18-7743
KIT CARBURADOR
Reemplaza: 67F-W0093-00-00
Para: (1999-02) F80/F100



18-7744
KIT CARBURADOR
Reemplaza: 6N6-W0093-02-00
Para: (1990-91) 115, 130, L130



18-7747
KIT CARBURADOR
Reemplaza: 6G5-W0093-08-00
Para: (1985-86) 150/175/200, V6 especial



18-7756
KIT CARBURADOR
Reemplaza: 64D-W0093-00-00
Para: (1996-01) 150/150L/175 (1996-99)
200/L200 (2000-01) 150/175 (1997-98)
D150

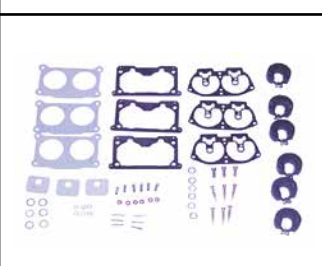

18-7759
KIT CARBURADOR
Reemplaza: 6K7-W0093-09-00
Para: (1990-91) 150/175/200 (1991-92) P200



18-7765
KIT CARBURADOR
Reemplaza: 6G1-W0093-00-00



18-7766
KIT CARBURADOR
 Reemplaza: 6H3-W0093-02-00
 (3) de 18-7766 = (1) de 6H3-W0093-02-00

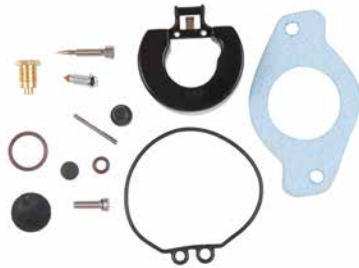

18-7767
KIT CARBURADOR
 Reemplaza: 6H4-W0093-01-00
 (3) de 18-7767 = (1) de 6H4-W0093-01-00



18-7768
KIT CARBURADOR
 Reemplaza: 6H4-W0093-03-00
 (3) 18-7768 = (1) 6H4-W0093-03-00



18-7769
KIT CARBURADOR
 Reemplaza: 6E7-W0093-04-00



18-7770
KIT CARBURADOR
 Reemplaza: 689-W0093-02-00



18-7772
KIT CARBURADOR
 Reemplaza: 61A-W0093-01-00, 61A-W0093-00-00
 Para: (1991-96) 225/250 3.1 litro, L225, L250



18-34600
CARBURADOR
 Reemplaza: 66M-14301-00-00,
 66M-14301-12-00
 Para: F15(2006 & Sup)



18-34601
CARBURADOR
 Reemplaza: 67D-14301-13-00
 Para: F4(2005 & Sup)



18-34602
CARBURADOR
 Reemplaza: 65W-14901-12-00
 Para: F25(1998-03)



18-34603
CARBURADOR
 Reemplaza: 63V-14301-00-00
 Para: 9.9(1996-03), 15(1996-03)



18-34604
CARBURADOR
 Reemplaza: 69M-14301-11-00
 Para: F2.5MSH(2006 & Sup)



18-34605
CARBURADOR
 Reemplaza: 66T-14301-00-00
 Para: T40/T30 Enduro Series



18-7049
VÁLVULA DE AGUJA
 Reemplaza: 62Y-14392-00-00, 61N-14392-00-00,
 6L2-14392-00-00
 Para: C30(1993-97)



18-7054
VÁLVULA DE AGUJA
 Reemplaza: 6G1-14546-00-00, 6G1-14546-01-00
 Para: 3(1988-02), 6(1986-00), 8(1984-03), 9.9(1996-03),
 15(1996-03), F25(1998-03), F30(2000-02), F40(2000-02),
 T25(2001-03)



18-7055
VÁLVULA DE AGUJA
 Reemplaza: 6E5-14546-00-00,
 6J8-14546-00-00
 Para: 25 MLHV3(1997), 25MLHW3(1998), 25
 MSHV3(1997), 25 MSHW3(1998), 30(1987-98),
 115(1986-09), 130(1988-04), 150(1986-09), 175(1986-
 95, 2000), 200(1986-98), 225(1990-97),
 B115(1998-99), 250(1991-95), C115(1991-00),
 C150(1996-99), D150(1997-99), L130(1989-01),
 L150(1986-99), L200(1986-99), L225(1994-99),
 L250(1990-96), P115(1993-96), P150(1991-99),
 P175(1994-99), P200(1991-99), S115(1996-99),
 S130(1996-99), S150(1996-99), S175(1996-
 99), S200(1996-99), S225(1996), S250(1996),
 V150(2000-08), V175(2000)



18-7056
VÁLVULA AGUJA
Reemplaza: 6H3-14590-00-00, 6H3-14590-01-00, 67F1439A-00-00, 6H2-14591-00-00
Para: 40(1984-92), 50(1984-92), 70(1984-01), C40(1991-94), C60(1996-01), C70(2000-01), CV40(1990), E60(1995-00), F80(2000-02), F100(2000-02), P50(1991-92), P60(1991-99)



18-7060
VÁLVULA AGUJA
Reemplaza: 692-14590-00-00, 692-14590-01-00
Para: 90(1984-02), B90(1997-99), C75(1994-99), C80(1997), C85(1991-96), C90(1997-01), CV85(1989-90), E75(1995-00), P75(1996-99)



18-7073
VÁLVULA AGUJA
Reemplaza: 6E8-14380-12-00, 6E7-14390-12-00
Para: 9.9(1986-95), 15(1986-95)



18-7079
VÁLVULA AGUJA
Reemplaza: 626-14390-90
Para: 9.9(1984-85), 15(1984-85)



18-7063
FLOTADOR
Reemplaza: 6L2-14385-00-00
Para: 20(1996-97), 25(1988-09), C30(1993-97), F15(1989-06), F40(1999), F50(1995-03), F60(2002-04), F9.9(2005-06), T50(1996-04), T60(2003-04), T9.9(2005-06)



18-7064
FLOTADOR
Reemplaza: 63V-14985-00
Para: 9.9(1996-09), 15(1996-09), F25(1998-13), F30(2001-05), F40(2000-08), T25(2001-13)



18-7065
FLOTADOR
Reemplaza: 647-14385-00-00
Para: 4(1984-85), 5(1984-85), 9.9(1984-85), 15(1984-85)



18-7066
FLOTADOR
Reemplaza: 648-14385-00-00
Para: 25(1984-87), 30(1984-86), C25(1991-97), C30(1991-92), Cv25(1990), CV30(1989-90)



18-7067
FLOTADOR
Reemplaza: 6G1-14985-00-00
Para: 3(1988-02), 6(1986-00), 8(1984-00), 40(1984-88), 50(1984-88), 70(1984-91), C60(1996-01), E60(1995-00), PRO 50(1987-88), P60(1991)



18-7068
FLOTADOR
Reemplaza: 6E5-14385-01-00, 6E5-14385-00-00
Para: 115(1984), 150(1984), 175(1984), 200(1984)



18-7069
FLOTADOR
Reemplaza: 6E5-14385-02-00
Para: 115(1986-09), 130(1988-04), 150(1986-09), 175(1986-00), 200(1986-98), 200(1990-97), B115(1998-99), C115(1991-00), C150(1996-99), D150(1997-99), L130(1989-01), L150(1986-99), L200(1986-99), P115(1993-96), P150(1991-99), P175(1994-99), P200(1991-99), PRO150(1986-90), S115(1996-99), S130(1996-99), S150(1996-99), S175(1996-99), S200(1996-99), V150(2000-08), V6 Excel(1987-89), V6 Special(1986)



18-7392
FLOTADOR
Reemplaza: 676-14985-01-00
Para: 90(1984-90), C40(1991-97), C75(1994-99), C80(1997), C85(1991-96), CV40(1990), CV85(1989-90), E75(1995-00)



18-7393
FLOTADOR
Reemplaza: 6E7-14385-00-00
Para: 4(1986-94), 5(1994), 9.9(1986-95), 15(1986-95)



18-0710
JUNTA CAMARA DE FLOTADOR
Reemplaza: 68V-14984-00
Para: F115 (2000-10), LF115 (2000-10), F200 (2002-10), LF200 (2002-10), F225(2002-05), LF225(2002-05), F225TXR modelos(2007-10), LF225TXR modelos(2007-10)



18-0711
JUNTA CAMARA DE FLOTADOR
Reemplaza: 66K-14984-00
Para: DX 150(1999-05), LX 150(1999-01), LZ 150(2000-05), PX 150(1999), VX 150(2000-04), VZ 150(2000-10), Z 150(2000-05), VZ 175(2001-10), Z175(2001-05), LX200(1999-01), LZ200(2000-10), SX200(1999-05), V200(1999), VX200(2000-05), VZ200(2001-09), Z200 (2000-10), L225(1999), LX225(2000-03), S225(1999), SX225(2000-03), V225(1999), VX225(2000-04), VZ225(2003-09), L250(1999), LX250(2000-03), LZ250(2003-05), S250(1999), SX250(2000-03), VX250(2002-04), VZ250(2003-09), Z250(2003-05), LZ300(2004-06), VZ300(2004-09), Z300(2004-06)



18-0712
JUNTA CAMARA DE FLOTADOR
Reemplaza: 63P-14984-00
Para: F150 TLR (2004-10), F150 TXR (2004-10), LF150 TXR (2004-10)



18-0713
JUNTA CAMARA DE FLOTADOR
Reemplaza: 6P2-14984-00
Para: F225TLR(2007-09), F250(2005-10), LF250(2005-10)



18-0714
JUNTA CAMARA DE FLOTADOR
Reemplaza: 6AW-14984-00
Para: F300(2007-09), LF300(2007-09), F350(2007-10), LF350(2007-10)



18-0715
JUNTA CAMARA DE FLOTADOR
 Reemplaza: 65L-14984-00
 Para: V200(1998), L225(1997-98), S225(1997-98), V225(1998), L250(1997-98), S250(1997-98)

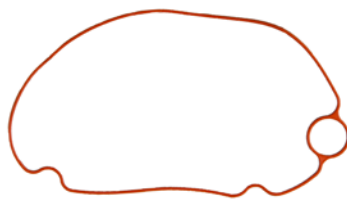

18-0716
JUNTA CAMARA DE FLOTADOR, VITON
 Reemplaza: 6CB-14984-00
 Para: F115(2001-14), F200(2011-14), F225(2010-14), F250(2010-14), F300(2010-14), F350(2011-14), FL250(2010), FL300(2010), LF115(2011-14), LF200(2011-14), LF225(2010-14), LF250(2010-14), LF300(2010-14), LF350(2011-14), VF150(2013-14), VF200(2010-14), VF225(2010-14), VF250(2009-14)

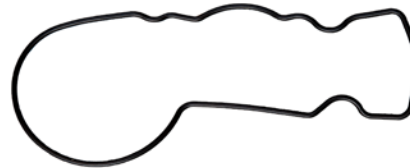

18-0717
JUNTA CAMARA FLOTADOR, VITON
 Reemplaza: 6C5-14984-00
 Para: F50(2005-14), F60(2005-14), F70(2010-14), F75(2005-14), F90(2005-14), T50(2005-14), T60(2005-14)



18-99146
JUNTA CAMARA FLOTADOR
 Reemplaza: 677-14384-01
 Para: 9.9(1984-95), 15(1984-95)



18-0707
RETÉN, VITON
 Reemplaza: 6CB-13016-00
 Para: F115(2011-14), F175(2014), F200(2011-14), F225(2010-14), F250(2010-14), F300(2010-14), F350(2012-14), FL250(2010), FL300(2010), LF115(2011-14), LF200(2011-14), LF225(2010-14), LF250(2010-14), LF300(2010-14), LF350(2012-14), VF150(2013-14), VF200(2010-14), VF225(2009-14), VF250(2009-14)









H.P.	Año	kit carb	Por motor	Válvula aguja	Por motor	H.P.	Año	Kit carb	Por motor	Válvula aguja	Por motor
2	1984-88	18-7293	1			60	2001-02				3
3	1988-02	18-7765	1	18-7054	1	C60	1996-01	18-7766	3	18-7056	3
F4	1999-02	18-7736	1			E60	1995-00	18-7766	3	18-7056	3
6	1986-96	18-7765	1	18-7054	1	P60	1991	18-7766	3	18-7056	3
6	1997-00		1	18-7054	1	P60	1992-99			18-7056	3
8	1984-96	18-7765	1	18-7054	1	70	1984-91	18-7766	3	18-7056	3
8	1997-00		1	18-7054	1	70	1992-01			18-7056	3
9.9	1984-85	18-7059	1	18-7079	1	C70	2000-01			18-7056	3
9.9	1986-95	18-7769	1	18-7073	1	C75	1994-97	18-7291	3	18-7060	3
9.9	1996-03	18-7058	1	18-7054	1	C75	1998-99	18-7742	3	18-7060	3
9.9	2004-09	18-7058	1			E75	1995-00	18-7291	3	18-7060	3
F9.9	2006	18-7738	1			P75	1996-99			18-7060	3
T9.9	2005-06	18-7738	1			C80	1997	18-7742	3	18-7060	3
15	1984-85	18-7059	1	18-7079	1	F80	1999-02	18-7743	3	18-7056	3
15	1986-92	18-7769	1	18-7073	1	C85	1991-96	18-7291	3	18-7060	3
15	1993-95		1	18-7073	1	CV85	1989-90	18-7291	3	18-7060	3
15	1996-03	18-7058	1	18-7054	1	90	1984-91	18-7291	3	18-7060	3
15	2004-09	18-7058	1			90	1992-02			18-7060	3
F15	1998-05	18-7738	1			B90	1997-99			18-7060	3
20	1996-97	18-7739	1			C90	1997-01			18-7060	3
25 (2 cil)	1984-87	18-7770	1			F100	1999-02	18-7743	3	18-7056	3
25 (2 cil)	1988-09	18-7739	1			115	1986-88, 1992-95	18-7002	2	18-7055	4
F25	1998-03		1	18-7054	1	115	1990-91	18-7744	2	18-7055	4
C25	1991-1997	18-7770	1			115	1992-09		2	18-7055	4
CV25	1990	18-7770	1			B115	1998-99			18-7055	4
T25	2001-03		1	18-7054	1	C115	1991			18-7055	4
30	1984-86	18-7770	1			C115	1992-95	18-7002	2	18-7055	4
30	1987-98		1	18-7055	1	C115	1996-00			18-7055	4
F30	2000-02		1	18-7054	1	P115	1993-96	18-7002	2	18-7055	4
C30	1991-92	18-7770	1			S115	1996-99			18-7055	4
C30	1993-97	18-7737	1	18-7049	1	130	1988, 1992-95	18-7002	2	18-7055	4
CV30	1989-90	18-7770	1			130	1990-91	18-7744	1	18-7055	4
40	1984-88	18-7767	3	18-7056	3	130	1992-04			18-7055	4
40	1989-92	18-7768	3	18-7056	3	L130	1989			18-7055	4
40	1993-05	18-7768	3			L130	1990-91	18-7744	1	18-7055	4
F40	2000-02			18-7054	3	L130	1992-95	18-7002	2	18-7055	4
C40	1991-93	18-7740	1	18-7056	2	L130	1996-01			18-7055	4
C40	1994-97	18-7741	1			S130	1996-99			18-7055	4
C40	2002-03	18-7768	3			150	1985-86	18-7747	1	18-7055	6
P40	1998	18-7768	1			150	1987, 1992-95	18-7002	3	18-7055	6
E48	1995-00	18-7290	2		*	150	1990-91	18-7759	1	18-7055	6
50	1984-88	18-7767	3	18-7056	3	150	1996-01	18-7756	3	18-7055	6
50	1989-92	18-7768	3	18-7056	3	150	2002-09			18-7055	6
50	1993 & Sup	18-7768	3			C150	1996-99	18-7756	3	18-7055	6
C50	1998-01	18-7768	3			D150	1997-99	18-7756	3	18-7055	6
PRO 50	1987-88	18-7767	3			L150	1988, 1992-95	18-7002	3	18-7055	6
PRO 50	1989-90	18-7768	3			L150	1990-91	18-7759	1	18-7055	6
P50	1991-92	18-7768	3	18-7056	3	L150	1996-99	18-7756	3	18-7055	6
P50	1993-96	18-7768	3			Z150					
C55	1991-95	18-7290	2		*	P150	1991	18-7759	1	18-7055	6
CV55	1989-90	18-7290	2		*	P150	1992-95	18-7002	3	18-7055	6

① El kit contiene suficientes piezas para reconstruir 2 carburadores

APLICACIONES CONTINUAN EN LA SIGUIENTE PÁGINA

H.P.	Año	kit carburador	Por Motor	Válvula agujas	Por Motor	H.P.	Año	Kit carburador	Por motor	Válvula aguja	Por Motor
P150	1996-99	18-7756	3	18-7055	6	200	1996-98	18-7756	3	18-7055	6
PRO V150	1987	18-7002	3			L200	1988, 1992-95	18-7002	3	18-7055	6
PRO V150	1990	18-7759	1			L200	1990-91	18-7759	1	18-7055	6
S150	1996-99	18-7756	3	18-7055	6	L200	1996-99	18-7756	3	18-7055	6
V150	2000-01	18-7756	3			P200	1991	18-7759	1	18-7055	6
V150	2002-08			18-7055	6	P200	1993-95	18-7002	3	18-7055	6
175	1985-86	18-7747	2			P200	1996-99	18-7756	3	18-7055	6
175	1987, 1992-95	18-7002	3	18-7055	6	S200	1996-99	18-7756	3	18-7055	6
175	1990-91	18-7759	1	18-7055	6	V6 Special	1984-86	18-7747	2		
175	1992-95			18-7055	6	V6 Excel	1987-89	18-7759	1		
175	2000	18-7756	3	18-7055	6	225	1990-91	18-7759	1	18-7055	6
P175	1994-95	18-7002	3	18-7055	6	225	1992-95	18-7002	3	18-7055	6
P175	1996-99	18-7756	3	18-7055	6	225	1996-97	18-7756	3	18-7055	6
S175	1996-99	18-7756	3	18-7055	6	L225	1994-96	18-7772	6	18-7055	6
V175	2000	18-7756	3			S225	1996	18-7772	6	18-7055	6
200	1985	18-7747	2			250	1990-95	18-7772	6	18-7055	6
200	1986-87, 1992-95	18-7002	3	18-7055	6	L250	1991-96	18-7772	6	18-7055	6
200	1990-91	18-7759	1	18-7055	6	S250	1996	18-7772	6	18-7055	6

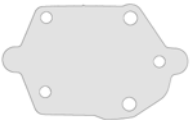
* Kit carburador contiene componentes suf. para reconstruir 2 carb

 <p>18-35302 ENS.BOMBA COMBUSTIBLE Reemplaza: 66M-24410-10-00 Para: F9.9(2005-06), T9.9(2005-06), F15(1998-06)</p>	 <p>18-35304 ENS.BOMBA COMBUSTIBLE Reemplaza: 67D-24410-03-00 Para: F4(2006-08)</p>		
 <p>18-7334 BOMBA COMBUSTIBLE Reemplaza: 692-24410-00-00, 663-24410-00-00, 6A0-24410-00-00, 6A0-24410-05-00, 6A0-24410-04-00, 6A0-24410-03-00, 6A0-24410-02-00, 6A0-24410-01-00 Para: 2-tiempos 40 HP - 90 HP (1984-2009). Use kit 18-7797</p>	 <p>18-7340 BOMBA COMBUSTIBLE Reemplaza: 68V-13907-03-00, 68V-13907-02-00, 68V-13907-01-00, 68V-13907-00-00 Para: F115(2000-04, 2006-11), LF115(2000-11)</p>	 <p>18-7341 BOMBA COMBUSTIBLE Reemplaza: 66K-13907-00-00 Para: DX150(1999-01), LX150(1999-01), LX200(1999-01), LX225(2000-01), LX250(2000-01), PX150(1999), SX150(1999-01), SX200(1999-01), SX225(2000-01), SX250(2000-01), V200(1999), V225(1999), VX150(2000-01), VX200(2000-01), VX225(2000-01)</p>	 <p>18-7342 BOMBA COMBUSTIBLE Reemplaza: 68F-13907-00, 68F-13907-01-00, 68F-13907-00-00 Para: LZ150(2000-05), LZ200(2000-12), VZ150(2000-12), VZ175(2001-12), VZ200(2001-04), Z150(2000-05), Z175(2001-05), Z200(2000-12)</p>
 <p>18-7343 BOMBA COMBUSTIBLE Reemplaza: 60V-13907-00-00 Para: LZ250(2003-05), LZ300(2004-06), VZ200(2005-09), VZ225(2003-09), VZ250(2003-09), VZ300(2004-09), Z250(2003-05), Z300(2004-06)</p>	 <p>18-7349 BOMBA COMBUSTIBLE Reemplaza: 6E5-24410-03-00, 6E5-24410-10-00, 6E5-24410-04-00, 6E5-24410-02-00, 6E5-24410-01-00, 6E5-24410-00-00 Para: 2-tiempos 115 HP - 300 HP (1984-2004) Use Kit 18-7788</p>	 <p>18-7388 DIAFRAGMA Reemplaza: 6G1-24411-00-00 Para: 3(1988-02), 6(1986-00), 8(1984-09), 9.9(1996-09), 15(1996-09)</p>	 <p>18-7389 DIAFRAGMA Reemplaza: 6E0-24411-00-00 Para: 4(1984-99), 5(1984-85, 1994-02)</p>
 <p>18-7390 DIAFRAGMA Reemplaza: 63V-24411-00-00 Para: 9.9(1996-09), 15(1996-09)</p>	 <p>18-7391 DIAFRAGMA Reemplaza: 692-24411-00-00 Para: 40(1995-05), 50(1995-09), 60(2001-05), 70(1995-09), 90(1995-09), B90(1997-99), C25(1996-97), C30(1996-97), C40(1995-03), C50(1998-01), C55(1995), C60(1996-01), C70(2000-01), C75(1995-99), C80(1997), C85(1995-96), C90(1997-01), E48(1995-00), E60(1995-00), E75(1995-00), P40(1998), P50(1995-96), P60(1995-99), P75(1996-99)</p>	 <p>18-7787 KIT BOMBA COMBUSTIBLE Para: 40-90 HP — CONTIENE — Ref # Descripción O.E. # 18-7840 Diafragma (Front) 663-24411-00-00 18-7839 Diafragma 648-24411-00-00</p>	 <p>18-7788 KIT BOMBA COMBUSTIBLE Reemplaza: 6E5-24411-00-00 (V-4, V-6) — CONTIENE — Ref # Descripción O.E. # 18-7843 Junta (Post.) 6E5-24411-00-00 18-7842 Diafragma (Sup.) 6E5-24411-00-00</p>



18-7367
KIT BOMBA COMB.
Contiene: 18-7833 & 18-7388

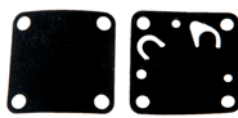

18-7368
KIT BOMBA COMB.
Contiene: 18-7834 & 18-7389

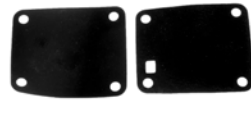

18-7369
KIT BOMBA COMB.
Contiene: 18-7388 & 18-7390



18-7797
KIT BOMBA COMB.
Contiene: 18-7839 & 18-7840



18-7798
KIT BOMBA COMB.
Contiene: 18-7838 & 18-7837



18-7799
KIT BOMBA COMB.
Contiene: 18-7842 & 18-7843



18-7833
DIAFRAGMA BOMB.COMB.
Reemplaza: 6G1-24471-00-00



18-7834
DIAFRAGMA BOMB.COMB.
Reemplaza: 6E0-24471-00-00



18-7837
DIAFRAGMA BOMB.COMB.
Reemplaza: 677-24411-02-00



18-7838
DIAFRAGMA BOMB.COMB.
Reemplaza: 677-24471-01-00



18-7839
DIAFRAGMA BOMB.COMB.
Reemplaza: 648-24411-00-00



18-7840
DIAFRAGMA BOMB.COMB.
Reemplaza: 663-24411-00-00



18-7841
DIAFRAGMA BOMB.COMB.
Reemplaza: 6J8-24471-00-00



18-7842
DIAFRAGMA BOMB.COMB.
Reemplaza: 6E5-24471-00-00



18-7843
DIAFRAGMA BOMB.COMB.
Reemplaza: 6E5-24411-00-00

Modelo	Año	Diafragma	Kits	Modelo	Año	Diafragma	Kits	Modelo	Año	Diafragma	Kits
3	1988-02	18-7833 / 18-7388	18-7367	E75	1995-00	18-7840		Z175	2001-01	18-7842	
4	1984-99	18-7834 / 18-7389	18-7368	P75	1996-99	18-7840		Z175	2002-04	18-7842 / 18-7843	18-7799
5	1984-85	18-7834 / 18-7389	18-7368	C80	1997	18-7840		200	1984-98	18-7842 / 18-7843	18-7799
5	1986-91	18-7834		85	1990	18-7798		L200	1986-99	18-7842 / 18-7843	18-7799
5	1994-02	18-7834 / 18-7389	18-7368	C85	1991-94	18-7839 / 18-7840	18-7797	LX200	1999-01	18-7842	
6	1986-00	18-7833 / 18-7388	18-7367	C85	1995-96	18-7840		LZ200	2000-01	18-7842	
8	1984-09	18-7833 / 18-7388	18-7367	CV85	1989-90	18-7839 / 18-7840	18-7797	LZ200	2002-04	18-7842 / 18-7843	18-7799
9,9	1984-95	18-7837 / 18-7388	18-7798	90	1984-94	18-7839 / 18-7840	18-7797	P200	1991-99	18-7842 / 18-7843	18-7799
9,9	1996-09	18-7388 / 18-7390	18-7369	90	1995-09	18-7840		S200	1996-99	18-7842 / 18-7843	18-7799
15	1984-95	18-7837 / 18-7838	18-7798	B90	1997-99	18-7840		SX200	1999-01	18-7842	
15	1996-09	18-7388 / 18-7390	18-7369	C90	1997-01	18-7840		SX200	2002-04	18-7842 / 18-7843	18-7799
20	1986-97	18-7837		I15	1984-04	18-7842 / 18-7843	18-7799	V200	1999	18-7842	
25	1984-87	18-7840		B115	1998-99	18-7842 / 18-7843	18-7799	V200	1998	18-7842 / 18-7843	18-7799
25	1984-87			C115	1991-00	18-7842 / 18-7843	18-7799	VX200	2000-01	18-7842	
25	1988-09	18-7837		P115	1993-96	18-7842 / 18-7843	18-7799	VX200	2002-04	18-7842 / 18-7843	18-7799
C25	1991-95	18-7840	18-7797	S115	1996-99	18-7842 / 18-7843	18-7799	VZ200	2001	18-7842	
C25	1986-97	18-7840		I30	1988-04	18-7842 / 18-7843	18-7799	VZ200	2002-04	18-7842 / 18-7843	18-7799
CV25	1990	18-7839 / 18-7840	18-7797	C150	1996-99	18-7842 / 18-7843	18-7799	Z200	2000-01	18-7842	
25	1990	18-7837		L130	1989-99	18-7842 / 18-7843	18-7799	Z200	2002-04	18-7842 / 18-7843	18-7799
30	1984-86	18-7839 / 18-7840	18-7797	L130	2000-01	18-7842		225	1990-97	18-7842 / 18-7843	18-7799
30	1987-90	18-7841		S130	1996-99	18-7842 / 18-7843	18-7799	L225	1994-99	18-7842 / 18-7843	18-7799
30	1991-02	18-7841		I50	1984-04	18-7842 / 18-7843	18-7799	LX225	2000-01	18-7842	
C30	1991-95	18-7839 / 18-7840	18-7797	D150	1997-99	18-7842 / 18-7843	18-7799	LX225	2002-03	18-7842 / 18-7843	18-7799
C30	1996-97	18-7840		L150	1986-99	18-7842 / 18-7843	18-7799	S225	1996-99	18-7842 / 18-7843	18-7799
CV30	1989-90	18-7839 / 18-7840	18-7797	LX150	1999-01	18-7842		SX225	2000-01	18-7842	
40	1984-94	18-7839 / 18-7840	18-7797	LZ150	2000-01	18-7842		SX225	2002-03	18-7842 / 18-7843	18-7799
40	1995-01	18-7840		LZ150	2002-04	18-7842 / 18-7843	18-7799	V225	1999	18-7842	
C40	1991-94	18-7839 / 18-7840	18-7797	DX150	1999-01	18-7842		V225	1998	18-7842 / 18-7843	18-7799
C40	1995-02	18-7840		DX150	2002-04	18-7842 / 18-7843	18-7799	VX225	2000-01	18-7842	
CV40	1990	18-7839 / 18-7840	18-7797	P150	1991-99	18-7842 / 18-7843	18-7799	VX225	2002-04	18-7842 / 18-7843	18-7799
P40	1998	18-7840		S150	1996-99	18-7842 / 18-7843	18-7799	VZ225	2003-04	18-7842 / 18-7843	18-7799
E48	1995-00	18-7840		SX150	1999-01	18-7842		250	1990-95	18-7842 / 18-7843	18-7799
50	1986-94	18-7839 / 18-7840	18-7797	SX150	2002-04	18-7842 / 18-7843	18-7799	L250	1990-99	18-7843	
50	1995-09	18-7840		V150	2000-01	18-7842		LX250	2000-01	18-7842	
C50	1998-01	18-7840		V150	2002-04	18-7842 / 18-7843	18-7799	LX250	2002-03	18-7842 / 18-7843	18-7799
P50	1991-94	18-7839 / 18-7840	18-7797	VX150	2000-01	18-7842		LZ250	2003-04	18-7842 / 18-7843	18-7799
P50	18-1995-96	18-7840		VX150	2002-01	18-7842 / 18-7843	18-7799	S250	1996-99	18-7842 / 18-7843	18-7799
55	1990	18-7798		VZ150	2000-04	18-7842		SX250	2000-01	18-7842	
C55	1991-94	18-7839 / 18-7840	18-7797	VZ150	2002-04	18-7842 / 18-7843	18-7799	SX250	2002-03	18-7842 / 18-7843	18-7799
CV55	1989-90	18-7839 / 18-7840	18-7797	Z150	2000-01	18-7842		VX250	2002-04	18-7842 / 18-7843	18-7799
60	2001-05	18-7840		Z150	2002-04	18-7842 / 18-7843	18-7799	VZ250	2003-04	18-7842 / 18-7843	18-7799
C60	1996-01	18-7840		PRO 150H	1987	18-7798		Z250	2003-04	18-7842 / 18-7843	18-7799
E60	1995-00	18-7840		175	1984-95	18-7842 / 18-7843	18-7799	LZ300	2004	18-7842 / 18-7843	18-7799
P60	1991-94	18-7839		175	1996-00	18-7842		VZ300	2004	18-7842 / 18-7843	18-7799
70	1984-94	18-7839 / 18-7840	18-7797	P175	1994-99	18-7842 / 18-7843	18-7799	Z300	2004	18-7842 / 18-7843	18-7799
70	1995-09	18-7840		S175	1996-99	18-7842 / 18-7843	18-7799	V6			
C70	2000-01	18-7840		V175	2000	18-7842		Special	1984-86	18-7842 / 18-7843	18-7799
C75	1994	18-7839 / 18-7840	18-7797	VZ175	2001	18-7842		V6 Excel	1987-89	18-7842 / 18-7843	18-7799
C75	1995-99	18-7840		VZ175	2002-04	18-7842 / 18-7843	18-7799				

SOPORTES SEPARADORES COMBUSTIBLE/AGUA



Tipo soporte	Ref #	Reemplaza	Tipo	Ref #	Reemplaza
1/4" Acero inox	18-7777	MAR-FLTHD-SS-12	1/4" Aluminio	18-7853-1	MAR-FLTHD-AL-12
3/8" Acero inox	18-7776		3/8" Aluminio	18-7775	

KITS SEPARADORES COMBUSTIBLE/AGUA



**KITS FILTROS DE 21 MICRAS
PARA MOTORES CON CARBURADOR**



Tipo kit	Ref #	Micras	Contenido	Reemplaza
1/4" Aluminio (Filtro corto)	18-7848-1	21	1 - 18-7844 filtro & 1 18-7853-1 Soporte 2 - 18-4256 1/4" tapones	
1/4" Pack Aluminio Contiene filtro recambio	18-7848-2	21	2 - 18-7844 filtro & 1 18-7853-1 Soporte 2 - 18-4256 1/4" tapones	
1/4" Aluminio (Filtro alto)	18-7852-1	21	1 - 18-7845 filtro & 1 18-7853-1 Soporte 2 - 18-4256 1/4" Tapones	MAR-SEPAR-AT-OR
1/4" Pack aluminio Contiene filtro recambio	18-7852-2	21	2 - 18-7845 filtro & 1 18-7853-1 Soporte 2 - 18-4256 1/4" Tapones	
3/8" Aluminio (Filtro alto)	18-7775-1	21	1 - 18-7845 filtro & 1 18-7775 Soporte 2 - 18-4264 3/8" Tapones	
1/4" Acero inox. (Filtro alto)	18-7777-1	21	1 - 18-7845 filtro & 1 18-7777 Soporte 2 - 18-4256 1/4" Tapones	ABB-SPRTR-HD-SS
3/8" Acero inox. (Filtro alto)	18-7776-1	21	1 - 18-7845 filtro & 1 18-7776 Soporte 2 - 18-4264 3/8" Tapones	



FILTROS DE 10 MICRAS PARA MOTORES DE INYECCIÓN

Tipo Kit	Ref #	Micras	Contenido	Reemplaza
1/4" Aluminio (Filtro corto)	18-7983-1	10	1 - 18-7944 filtro & 1 18-7853-1 soporte 2 - 18-4256 1/4" tapones	
1/4" Pack aluminio Contiene filtro recambio	18-7983-2	10	2 - 18-7944 filtro & 1 18-7853-1 soporte 2 - 18-4256 1/4" tapones	
1/4" Aluminio (Filtro alto)	18-7982-1	10	1 - 18-7945 filtro & 1 18-7853-1 soporte 2 - 18-4256 1/4" tapones	
1/4" Pack aluminio Contiene filtro recambio	18-7982-2	10	2 - 18-7945 filtro & 1 18-7853-1 Soporte 2 - 18-4256 1/4" tapones	
1/4" Aluminio (Filtro alta capacidad)	18-7966-1	10	1 - 18-7866 filtro & 1 18-7853-1 Soporte 2 - 18-4256 1/4" Tapones	MAR-SEPAR-AT-OR
3/8" Aluminio (Filtro alto)	18-7986-1	10	1 - 18-7945 filtro & 1 18-7775 Soporte 2 - 18-4264 3/8" Tapones	
1/4" Acero inox (Filtro alto)	18-7984-1	10	1 - 18-7945 filtro & 1 18-7777 Soporte 2 - 18-4256 1/4" Tapones	MAR-SPRTR-HD-SS
3/8" Acero inox (Filtro alto)	18-7985-1	10	1 - 18-7945 filtro & 1 18-7776 Soporte 2 - 18-4264 3/8" Tapones	



KITS FILTROS DE 10 MICRAS CON CAZOLETA DE DRENAJE

Permiten el drenaje y alargan, la vida útil del filtro. Usar AquaVue™ para fueraborda, instalaciones bajo cubierta.

Kit Tipo	Ref #	Micron Rating	Contiene
1/4" Aluminio con cazoleta AquaVue™	18-7932-1	10	1 - 18-7919 filtro & 1 18-7853-1 soporte 1 - 18-7922-1 Cazoleta AquaVue™ 2 - 18-4256 1/4" tapones
1/4" Aluminio con cazoleta metálica	18-7951	10	1 - 18-7919 filtro & 1 18-7853-1 soporte 1 - 18-7924 Cazoleta metálica 2 - 18-4256 1/4" tapones
1/4" Acero inox con cazoleta AquaVue™	18-7937-1	10	1 - 18-7919 filtro & 1 18-7777 soporte 1 - 18-7922-1 Cazoleta AquaVue™ 2 - 18-4256 1/4" tapones
1/4" Acero inox con cazoleta metálica	18-7938	10	1 - 18-7919 filtro & 1 18-7777 soporte 1 - 18-7924 Cazoleta metálica 2 - 18-4256 1/4" tapones

SOPORTE Y KIT - PARA APLICACIONES EN PEQUEÑOS FUERABORDAS Y AGUA DULCE



18-7774
SOPORTE DE ALUMINIO COMPACTO



18-7965-1
KIT SEPARADOR COMPACTO 10 MICRAS
Reemplaza: MAR-MINIF-LT-AS
Contiene:
1 - 18-7774 soporte
1 - 18-7865 Filtro

FILTROS DE RECAMBIO



DISEÑO UNIVERSAL
REEMPLAZO DIRECTO PARA MERCURY
PARA MERCURY Y YAMAHA

FILTROS DE RECAMBIO DE 10 MICRAS

Ref #	Descripción	Reemplaza
18-7944	Corto - 3.875"	
18-7945	Largo - 4.35"	ABB-FUELF-IL-TR
18-7866	Alta capacidad - 6"	MAR-FUELF-IL-TR
18-7865	Compacto 10 Micras	MAR-MINIF-IL-TR

FILTROS DE RECAMBIO DE 10 MICRAS

Ref #	Descripción	Reemplaza
18-7844	Corto - 3.875"	
18-7845	Largo - 4.35"	ABB-FUELF-IL-TR



FILTROS DE RECAMBIO DE 10 MICRAS Y
KITS CON CAZOLETA DE DRENAJE

FILTROS DE RECAMBIO

Ref #	Descripción	Reemplaza
18-7919	Recambio	MAR-24563-00-00 Racor S3213
18-7920	Recambio	Racor S3214
18-7947	Recambio • Para - 120RRAC01	Racor S3240
18-7948	Recambio • Para - 320RRAC01	Racor S3227
18-7949	Recambio • Para - 660RRAC02	Racor S3232

FILTROS DE RECAMBIO

Ref #	Descripción	Reemplaza
18-7922-1	Cazoleta AquaVue™	
18-7924	Cazoleta metálica	MAR-10171-00-10

FILTROS Y CAZOLETAS

Ref #	Descripción
18-7928-1	Filtro & AquaVue™ cazoleta • Tipo Mercury/Yamaha Contiene: 18-7919 filtro, cazoleta 18-7922-1
18-7929	Filtro & Cazoleta metálica • Tipo Mercury/Yamaha Contiene: 18-7919 filtro, Cazoleta 18-7924



18-8953
TAPA SEPARADORA DE
COMBUSTIBLE/AGUA
Para: Yamaha mini-10 talla filtro



18-8954
TAPA SEPARADORA DE
COMBUSTIBLE/AGUA
Para: Yamaha 18-7866 talla filtro

 <p>18-7486 ARO, CAZOLETA FILTRO COMBUSTIBLE Reemplaza: 61A-24564-00-00 Para: V6</p>	 <p>18-7487 ARO, ELEMENTO FILTRO COMBUSTIBLE Reemplaza: 65L-24564-00-00 Para: V6</p>	 <p>18-7488 JUNTA, CAZOLETA FILTRO COMBUSTIBLE Reemplaza: 6P3-24564-00-00 Para: F/LF 150 - F300 (2006 - Actual), VZ150 - VZ300 (2006 - Actual), Z200 - Z300 (2006 - Act.)</p>	 <p>18-7710 FILTRO COMBUSTIBLE Reemplaza: 68T-24251-00-00 Para: F6, F8 (2001 & Sup)</p>
--	--	--	--

 <p>18-7713 FILTRO COMBUSTIBLE (EN LINEA) Reemplaza: 646-24251-02-00 Para: 6 (1989, 1992-99), 8 (1989-99, 2001-02), F4 (1999-02), F9.9 (1989-95, 1997-99, 2001-02), FT 9.9 (1988-90)</p>	 <p>18-7780 FILTRO COMBUSTIBLE Reemplaza: 6F5-24563-00-00 Para: 9.9 - 225NR</p>	 <p>18-7781 FILTRO COMBUSTIBLE Reemplaza: 61N-24563-00-00 Para: 9.9/90° SX</p>	 <p>18-7782 FILTRO COMBUSTIBLE Reemplaza: 61A-24563-00-00 Para: V6, 3.1L, D-T</p>
---	--	---	--

 <p>FILTRO COMBUSTIBLE</p> <table border="1"> <tr> <th>Ref #</th> <th>Aplicación:</th> </tr> <tr> <td>18-7828-1</td> <td>1/4" Capacidad pequeña (Para 1/4" Línea combustible)</td> </tr> <tr> <td>18-7829</td> <td>1/4" Capacidad larga (Para 1/4" Línea combustible)</td> </tr> <tr> <td>18-7830</td> <td>5/16" Reemplaza: 65W-24251-10-00</td> </tr> <tr> <td>18-7831</td> <td>3/8"</td> </tr> </table>	Ref #	Aplicación:	18-7828-1	1/4" Capacidad pequeña (Para 1/4" Línea combustible)	18-7829	1/4" Capacidad larga (Para 1/4" Línea combustible)	18-7830	5/16" Reemplaza: 65W-24251-10-00	18-7831	3/8"	 <p>18-7955 ELEMENTO FILTRO COMBUSTIBLE 10 MICRONES Reemplaza: 68F-24563-10-00 Para: 150hp -300hp. (2004-2006) Modelos Z, VZ, LZ</p>	 <p>18-7979 FILTRO COMBUSTIBLE Reemplaza: 68V-24563-00-00</p>
Ref #	Aplicación:											
18-7828-1	1/4" Capacidad pequeña (Para 1/4" Línea combustible)											
18-7829	1/4" Capacidad larga (Para 1/4" Línea combustible)											
18-7830	5/16" Reemplaza: 65W-24251-10-00											
18-7831	3/8"											

 <p>18-79799 FILTRO COMBUSTIBLE Reemplaza: 6D8-WS24A-00-00 F50-F115 despues abril 2006 Para filtro alojamiento solo "6D8" !</p>	 <p>18-79809 FILTRO COMBUSTIBLE Reemplaza: 6P3-24563-01-00, 6P3-WS24A-00-00, 6P3-WS24A-01-00 F150, F200, F225, F250, Z-VZ 150 a 300 hp. posterior Abril 2006 Para filtro alojamiento solo"6P3"</p>	 <p>18-79905 FILTRO COMBUSTIBLE 10 MICRONES Reemplaza: 69J-24501-10-00 Para: F150 - F225 (2006 - Actual), F250 - (2005 -Actual)</p>
--	--	--

 <p>18-79970 FILTRO COMBUSTIBLE Reemplaza: 6BG-13915-00 Para: F30(2013), F40(2008-13), F50(2005-13), F60(2005-13), F70(2010-13), F75(2005-13), F90(2005-13), T50(2005-13), T60(2005-13)</p>	 <p>18-79972 ELEMENTO FILTRO (ENTRADA CARB) Reemplaza: 67F-14371-01 Para: F75(2003-04), F80(2002-03), F90(2003-04), F100(2002-03)</p>	 <p>18-79973 FILTRO COMBUSTIBLE Reemplaza: 6C5-13915-00 Para: F50(2005-13), F60(2005-13), F70(2010-13), F75(2005-13), F90(2005-13), T50(2005-13), T60(2005-13)</p>
--	---	---



18-79977
FILTRO COMBUSTIBLE
 Reemplaza: 6L5-24251-00
 Para: 3(1992-02), F2.5(2003-12), F4(1999-08)



18-79979
FILTRO COMBUSTIBLE
 Reemplaza: 6CB-24501-00
 F225 4.2L (2010), F250 4.2L (2010), F300 4.2L (2010), LF225 4.2L (2010), LF250 4.2L (2010), LF300 4.2L (2010), VF200 4.2L (2009-10), VF225 4.2L (2009-10), VF250 4.2L (2009-10)



18-79980
FILTRO COMBUSTIBLE
REEMPLAZA: 68F-24563-00
 Para: LZ150(2000-04), LZ200(2000-04), LZ250(2003-04), VZ150(2000-04), VZ175(2001-04), VZ200(2001-04), VZ225(2003-04), VZ250(2003-04), Z150(2000-04), Z175(2001-04), Z200(2000-04), Z250(2003-04)

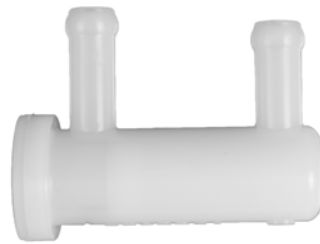

18-79981
FILTRO COMBUSTIBLE
 Reemplaza: 69J-24501-00
 Para: F150(2004-05), F200(2002-05), F225(2002-05), LF150(2004-05), LF200(2002-05), F225(2002-05)



18-79982
FILTRO COMBUSTIBLE
 Reemplaza: 69J-24502-00
 Para: F150(2005-14), F200(2005-10), F225(2005-10), F75(2005-14), F90(2005-14), FL150(2010), LF150(2005-14), LF200(2005-10), LF225(2005-10)



18-79983
FILTRO COMBUSTIBLE
 Reemplaza: 6C5-24251-00
 Para: F115(2014-15), F30(2013-15), F40(2008-15), F50(2005-15), F60(2005-15), F70(2010-15), F75(2005-15), F90(2005-15), LF115(2014-15), T50(2005-15), T60(2005-11), VF115(2015)



18-79984
FILTRO COMBUSTIBLE
 Reemplaza: 6AW-24502-10, 6AW-24502-00-00
 Para: 2007-09, F350(2007-11), FL350(2010), LF300(2007-09), LF350(2007-11)



18-79985
FILTRO COMBUSTIBLE
 Reemplaza: 68V-24502-30, 68V-24502-20-00
 Para: F115(2010-11), LF115(2010-11)



18-79986
FILTRO COMBUSTIBLE
 Reemplaza: 68V-24502-02, 68V-24502-01-00, 68V-24502-00-00
 Para: F115(2005-09), LF115(2005-09)



18-79907
FILTRO VST
 Reemplaza: 60V-24251-01-00
 Para: LZ150(2005), VZ150(2005-10), Z150(2005), VZ175(2005-10), Z175(2005), LZ200(2005-10), VZ200(2005-09), Z200(2005-10), VZ225(2005-09), LZ250(2005), VZ250(2005-09), Z250(2005), LZ300(2005-06), VZ300(2005-09), Z300(2005-06)



18-79900
FILTRO VST (TAN)
 Reemplaza: 66K-13915-00-00
 Para: DX150 (1999-05), LX150 1999-01, PX150 (1999), SX150 (1999-04), VX150 (2000-04), LX200 (1999-01), SX200 (1999-05), V200 (1999), VX200 (2000-05), L225 (1999), LX225 (2000-03), S225 (1999), SX225 (2000-03), V225 (1999), VX225 (2000-04), L250 (1999), LX250 (2000-03), SX250 (2000-03), VX250 (2002-04)



18-79901
FILTRO VST (azul)
 Reemplaza: 66L-13915-00-00
 Para: L225 (1997-98), S225 (1997-98), L250 (1997-98), V200 (1998), V225 (1998)

**18-79902
FILTRO VST**

Reemplaza:
63P-13915-00-00
Para: F150 TXR(2004-09), F150 TLR(2004-09), F150 TJR(2009), LF150 TXR(2004-09), F250 TXR(2005-09), F250 TUR(2005-09), F300 TXR(2007-09), F300 TUR(2007-09), F350 TXR(2007-09), F350 TUR(2007-09), F225TLR (2007-09)



**18-79903
FILTRO VST**

Reemplaza:
68V-13915-00-00
Para: F115 (2000-09), F200 TXR(2002-09), LF200 TXR(2002-09), F225 TXR(2002-09), F225 TUR(2002-09)



**18-79904
FILTRO VST (AMARILLO)**

Reemplaza:
68F-13915-00-00
Para: HPDI 150(2000-05), V-Max HPDI 150(2000-09), V-Max HPDI 175(2001-09), HPDI 200(2000-09), HPDI 225(2003-09), HPDI 250 (2003-09), HPDI 300(2004-09)



**18-79978
FILTRO VST**

Reemplaza: 6CB-13915-00
Para: F225 4.2L (2010), F250 4.2L (2010), F300 4.2L (2010), LF225 4.2L (2010), LF250 4.2L (2010), LF300 4.2L (2010), VF200 4.2L (2009-10), VF225 4.2L (2009-10), VF250 4.2L (2009-10)



**18-79910
FILTRO COMBUSTIBLE**

Reemplaza: 61N-24560-00, 61N-24560-10
Para: 15(1994-09), 20(1996-97), 25(1994-09), 30(1995-01), 40(1994-05), 50(1994-09), 60(2001-05), 70(1994-09), 9.9(1994-09), 90(1994-09), B90(1997-99), C25(1994-97), C30(1994-97), C40(1994-03), C50(1998-01), C55(1994-95), C60(1996-01), C75(1994-99), C80(1997), C85(1994-96), C90(1997-01), E48(1995-00), E60(1995-00), E75(1995-00), F15(2005-10), F20(2006-10), F25(2005, 2009-10), F40(1999), F50(1995-04), F9.9(2005-06)



**18-79950
KITS VST**

Reemplaza: Kit 1
Para: F150(04-12), LF150(04-12)



**18-79951
KITS VST**

Reemplaza: Kit 2
Para: F115(00-11), F200(02-10), F225(02-06), F225TXR(07-10), LF115(00-11), LF200(02-10), LF225(02-06), LF225 TXR(07-10)
Incluye filtro 18-79903 VST



**18-79952
KITS VST**

Reemplaza: Kit 3
Para: DX150(99-05), L225(99), L250(99), LX150(99-01), LX200(99-01), LX225(00-03), LX250(00-03), PX150(99), S225(99), S250(99), SX150(99-04), SX250(00-03), V200(99), V225(99), VX150(00-04), VX200(00-05), VX225(00-04), VX250(02-04)
Incluye 18-79900 VST filtro & 18-0711 junta



**18-79953
KITS VST**

Reemplaza: Kit 4
LZ150(00-05), LZ200(00-11), LZ250(03-05), LZ300(04-06), VZ150(00-11), VZ175(01-11), VZ200(01-09), VZ225(03-09), VZ250(03-09), VZ300(04-09), Z150(00-05), Z175(01-05), Z200(00-11), Z250(03-05), Z300(04-06)
Incluye 18-79904 VST filtro

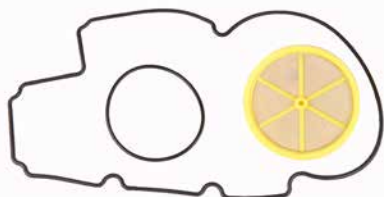

NEW

**18-79954
KIT VST FILTRO & JUNTA**

Para: F225TLR (2007-2009), F250 (2005-2010), LF250 (2005-2010)



NEW

**18-79955
KIT VST FILTRO & JUNTAS**

Para: F300 (2007-2009), LF300 (2007-2009), F350 (2007-2010), LF350 (2007-2010)



NEW

**18-79956
KIT VST FILTRO & JUNTA**

Para: F115 (2001-2014), F200 (2011-2014), F250 (2010-2014), F300 (2010-2014), F350 (2011-2014), FL250 (2010), FL300 (2010), LF115 (2011-2014), LF200 (2011-2014), LF225 (2010-2014), LF250 (2010-2014), LF300 (2010-2014), LF350 (2011-2014), VF150 (2013-2014), VF200 (2010-2014), VF225 (2010-2014), VF250 (2009-2014)



NEW

**18-79957
KIT VST FILTRO & JUNTA**

Para: F50 (2005-2014), F60 (2005-2014), F70 (2010-2014), F75 (2005-2014), F90 (2005-2014), T50 (2005-2014), T60 (2005-2014)



**18-2083
RETÉN INYECTOR COMBUSTIBLE**

Reemplaza:
68V-13766-00-00





18-7655
SENSOR OXÍGENO
 Reemplaza: 67H-8592A-01-00,
 67H-8592A-00-00
 Para: PX150 (1999), DX150 (99-05),
 LX150, LX200 (99-01), VX150 (00-04)



18-7656
SENSOR OXÍGENO
 Reemplaza: 68F-8592A-00-00
 Para: L225, L250 (98-99), LX225, LX250 (00-03), LZ150
 (00-05), LZ200 (00-12), S225, S250 (97-99), SX150 (99-
 04), SX200 (99-05), SX225, SX250 (00-03), V200, V225
 (98-99), VX200 (00-05), VX225 (98-05), VX250 (02-04),
 VZ150 (00-14), VZ175 (01-12), VZ200 (01-04), Z150 (00-
 05), Z175 (01-05), Z200 (00-12)



18-7606
SENSOR DE AGUA
 Reemplaza: MAR-10171-30-00

LÍNEAS DE COMBUSTIBLE LONGITUD 2,44 mts.

3/8"
LÍNEA DE COMB.

18-8017EP-1 SILVERADO 4000 Premium

OE# 6YL-24306-60-00



18-8077-1
CONECTOR
DEPÓSITO
 (SE VENDE SEPARADO)



18-8076
CONECTOR
COMBUSTIBLE

18-8005EP-1
BOMBA MANUAL

18-8076
CONECTOR
COMBUSTIBLE



*

*

COMPONENTES DE LA LÍNEA DE COMBUSTIBLE
 Para: F75-F250 y 115-300 HP

INTRODUCING THE NEW ARGENT PRO GAUGE SERIES



Gauged to impress.

All the elements of style paired with accuracy and reliability. Argent Pro gauges add another dimension in Sierra's already impressive line of marine instrumentation.

See page 8 for more information.





BOMBA DE MANO



18-8002EP-1
18-8002EP-1-10①
BOMBA DE MANO
 1/4"

18-8005EP-1
18-8005EP-1-10①
BOMBA DE MANO
 3/8"
 Reemplaza: 174512
 Gran capacidad

18-8004EP-1
18-8004EP-1-10①
BOMBA DE MANO
 5/16"
 Gran capacidad

18-8040
CODO DEPÓSITO
 Rosca
 1/4" NPT
 Reemplaza: ABA-FBARB-90-DG
 (Latón)

18-8055
CONECTOR MANGUERA
 1/4" NPT dientes conector manguera de 5/16" D.I
 Reemplaza: ABA-FLINE-BA-RB
 (Latón)

18-8077-1
18-8077-1-10①
CONECTOR DEPÓSITO
 (1/4" NPT)
 Para: F75-F250 y 115-300HP
 para: 18-80413, 18-80414, 18-80415

18-80413
CONECTOR COMBUSTIBLE
 1/4"
 Reemplaza: 6Y1-24305-06-00, 6Y1-24305-04
 Para: 18-8077-1

18-80414
CONECTOR COMBUSTIBLE
 Reemplaza: 6G1-24305-05-00, 6G1-24305-04
 Para: 6(1989,1992-93), 8(1984-85,1989-93,2001-02),
 9,9(1984-93, 2000-03), 15(1984-93, 2000-03),
 25(1984-85, 1988-93, 2000-03), 30(1984-87, 1989-93, 1999, 2001-02), 40(1984-86, 1988-90, 1992-93, 2000-03),
 50(1986-93, 2000-03), 60(2001-03), 70(1984-93, 2000-03), 90(1984-93, 2000-03), C25(1991, 1993), C30(1991-93),
 C40(1991-93, 2000-02), C50(2000-01), C55(1991-93), C60(2000-01), C70(2000-01), C85(1991-93), C90(2000-01),
 E48(2000), F6(2001-03), F8(2001-03), F9.9(1985-93, 2001-03), F15(1998-99, 2000-01), F25(1998-99, 2000-03),
 F30(2001-03), F40(1999, 2000-03), F50(1999, 2000-03), F60(2002-03), T8(2001-03), T9.9(1991-93, 1999, 2001-03),
 T25(2001-03), T50(1999, 2000-03), T60(2003)
 Use con Yamaha 6mm línea combustible
 Para 18-8077-1

18-80415
CONECTOR COMBUSTIBLE
 Reemplaza: 6E5-24305-05, 6Y2-24305-05
 Use con Yamaha 8mm línea combustible
 Para: 18-8077-1





















18-9145
KIT ABRAZADERAS
 Reemplaza: YB-6AW04-A

Ref #	Cnt.	Yamaha #	Oetiker #	Descripción
18-9141	1	YB-6AW04-4	14100082	Tenazas
Ref #	cnt.	Yamaha #	Oetiker #	Nominal ID Pulg mm
18-9133-9	50	YB-6AW04-1	16700016	5/8" 15.7
18-9146-9	50	YB-6AW04-3	16702498	25/32" 19.8

Las abrazaderas se suministran en paquetes de 10.

* Depósitos y motores ilustrativos.

① Pack de 10 - Precio por embalaje

 <p>18-3040 IMPULSOR Reemplaza: 63V-44352-01-00 Para: T8 (2001-Sup) /9.9/15 (2-tiempos) (1996-Sup)/F15 (1998-Sup), F20 (2006-Sup)</p>	 <p>18-3042 IMPULSOR Reemplaza: 67F-44352-00-00 Para: F75 (03-05), F80 Jet Drive (2001-02), F80 (1999-03), F100 (1999-02), F90 (2003-05), F90 Jet Drive (2003-04)</p>	 <p>18-3063 IMPULSOR Reemplaza: 662-44352-01-00 (6/8 HP)</p>	 <p>18-3065 IMPULSOR Reemplaza: 6L2-44352-00-00 (25 HP)</p>
 <p>18-3066 IMPULSOR Reemplaza: 6G1-44352-00-00 (6 & 8 HP)</p>	 <p>18-3067 IMPULSOR Reemplaza: 689-44352-02-00 (25 HP)</p>	 <p>18-3068 IMPULSOR Reemplaza: 6H4-44352-00-00, 6H4-44352-02-00 (30,40,50 HP)</p>	 <p>18-3069 IMPULSOR Reemplaza: 6H3-44352-00-00, 697-44352-00-00 55, 60, 70 HP, F50, T50</p>
 <p>18-3070 IMPULSOR Reemplaza: 688-44352-03-00 (C75, C85, 90 HP)</p>	 <p>18-3071 IMPULSOR Reemplaza: 6E5-44352-00-00, 6E5-44352-01-00 (115, 150, 175, 200, 250 HP)</p>	 <p>18-3072 IMPULSOR Reemplaza: 646-44352-01-00 (2 HP)</p>	 <p>18-3073 IMPULSOR Reemplaza: 6E0-44352-00-00 (4 & 5 HP)</p>
 <p>18-3074 IMPULSOR Reemplaza: 682-44352-01-00 (9.9,15 HP)</p>	 <p>18-3088 IMPULSOR Reemplaza: 6F5-44352-00-00 (C40 HP)</p>	 <p>18-8910 IMPULSOR Reemplaza: 68T-44352-00-00 Para: F6, F8 (2001-Sup)</p>	 <p>18-8911 IMPULSOR Reemplaza: 6L5-44352-00-00 Para: 3(1988-02), F2.5(2003-12)</p>
 <p>18-8925 IMPULSOR Reemplaza: 6AW-44352-00-00 Para: F300, F350, LF 300, LF 350 & FL350 (2006 & Sup)</p>	 <p>18-43716 PASADOR IMPULSOR Reemplaza: 93604-18080-00 Para: 3(1988-02), 4(1984-99), 5(1984-01), F2.5(2003-14), F4(1999-14), F6(2009-14)</p>	 <p>18-3162 ALOJAMIENTO IMPULSOR Reemplaza: 67F-44322-00-00 Para: F75 (2003-04), F80(1999-03), F90(2003-04), F100(1999-02)</p>	 <p>18-3164 ALOJAMIENTO IMPULSOR Reemplaza: 6L5-44322-00-00 Para: F2.5 (2003-04), 3 (1988-99, 2002)</p>

 <p>18-3456 ALOJAMIENTO IMPULSOR Reemplaza: 6G1-44322-00-00 Para: 6 (1986-00), 8 (1984-05)</p>	 <p>18-3333 ALOJAMIENTO IMPULSOR Reemplaza: 61A-44322-00-00</p>	 <p>18-3435 ALOJAMIENTO IMPULSOR Reemplaza: 663-44322-00-00</p>	 <p>18-3328 ALOJAMIENTO IMPULSOR Reemplaza: 646-44322-00-00 Para: 2 (1989,1991-99,2002)</p>
---	--	---	---

 <p>18-3443 ALOJAMIENTO IMPULSOR Reemplaza: 61N-44322-01-00 Para: (1998-03) F25, (1993-97) C30</p>	 <p>18-3444 ALOJAMIENTO IMPULSOR Reemplaza: 63V-44322-00-00 Para: 9.9/15 (1996-04), F15 (1998-04), F6/F8/T8 (20001-04)</p>	 <p>18-3449 ALOJAMIENTO IMPULSOR Reemplaza: 63D-44322-00-00 Para: 40 (1995-04), 50 (1995-97, 1999-04)</p>	 <p>18-3519 ALOJAMIENTO IMPULSOR Reemplaza: 61A-44322-02-00 Para: F225 despues 04/2007 / F250 despues 4/2006</p>	 <p>18-3185 BOMBA AGUA ALOJAMIENTO Reemplaza: 61N-44311-01-00, 61N-44311-00-00 Para: C30 (1993-97), F25 (1998-06)</p>
---	---	--	---	--



 <p>18-43263 BOMBA AGUA ALOJ. Reemplaza: 68D-G4311-01-00 Para: Yamaha F4(2002-08)</p>	 <p>18-3170 BOMBA AGUA ALOJ. Reemplaza: 6E5-44311-00-00</p>	 <p>18-3171 BOMBA AGUA ALOJ. Reemplaza: 688-44311-01-00</p>	 <p>18-3173-1 BOMBA AGUA ALOJ. Reemplaza: 61A-44311-00-00, 61A-44311-01-00</p>	 <p>18-3356 BOMBA AGUA ALOJ. Reemplazar: 63V-44301-00-00 Para: 2-tiempos: 9.9hp-15hp (1996-actual), 4-tiempos: 6hp-8hp (2001-actual); 9.9hp. (2006-actual); 15hp (1998-actual)</p>
---	---	---	--	--

TORNILLOS

Ref #	O.E. #	Aplicación
18-0256	97095-08045-00	8-1.25 x 45mm
	97080-08045-00	F6 (2001-05), F8 (2001-05) M8-1.25x45mm 18-8S/S
18-2605	90119-08M87-00	F80 (1999-03), F90 (2003-04), F100 (1999-02) M8-1.25x75mm 18-8 S/S
18-2606	90119-08M13-00	F80 (1999-03), F90 (2003-04), F100 (1999-02) M8-1.25x50mm 18-8 S/S
18-2607	97095-06040-00	Para: 3HP (1988-99, 2002) M8-1.0x40mm 18-8 S/S
18-8400-9①②	90119-08M15-00	8-1.25 x 29mm

LLAVE IMPULSORA

18-3297	90280-03M03-00
18-3305	90280-03024-00, 90280-03003-00
18-3300	90280-04M00-00
18-3301	90280-04M04-00
18-3302	90280-04M05-00

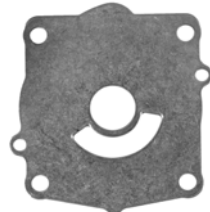
 <p>18-3518 PLATINA Reemplaza: 6P2-44323-00-00 Para: F225 despues 04/2007 / F250 despues 4/2006</p>	 <p>18-3520 PLATINA Reemplaza: 60X-44323-00-00 Para: VZ200 (3.3L) 2005-2010, VZ225 (3.3L) 2003-2010, VZ250 (3.3L) 2003-2010, VZ300 (3.3L) 2005-2010</p>	 <p>18-3521 PLATINA Reemplaza: 68V-44323-00-00 Para: F115 2002-2010 / LF115 2002-2010</p>
--	---	--



18-3194
PLATINA IMPULSOR
Reemplaza: 61N-44323-00
Para: C30 (1993-97), F25 (1998-06)



18-3357
PLATINA IMPULSOR
Reemplaza: 646-44323-00-00
Para: 2 (1989, 1991-99, 2002)



18-3142
PLATINA IMPULSOR
Reemplaza: 68T-44323-00-00
Para: F6, F8 (2001-05)



18-3143
PLATINA IMPULSOR
Reemplaza: 67F-44323-00-00
Para: F75 (2003-04), F80(1999-03), F90(2003-04), F100(1999-02)

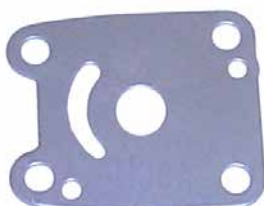

18-3163
PLATINA IMPULSOR
Reemplaza: 6L5-44323-00-00
Para: 3HP (1988-99, 2002)



18-3344
PLATINA IMPULSOR
Reemplaza: 6E5-44323-00-00



18-3345
PLATINA IMPULSOR
Reemplaza: 6G5-44323-00-00



18-3186
PLATINA IMPULSOR
Reemplaza: 63D-44323-00-00
Para: 40 (1995-04), 50 (1995-97, 1999-04)



18-3195
PLATINA IMPULSOR
Reemplaza: 63V-44323-00-00
Para: 9.9/15 (1996-04), F15 (1998-04)



18-3196
PLATINA IMPULSOR
Reemplaza: 66T-44323-00-00
Para: F30 (2001-04), F40 (2000-04), T25 (2001-04)



18-3436
PLATINA IMPULSOR
Reemplaza: 663-44323-00-00



18-1831
DAMPER RETÉN AGUA
Reemplaza: 682-44366-00
Para: 9.9(1984-95), 15(1984-95)



18-1832
DAMPER RETÉN AGUA
Reemplaza: 682-44367-00
Para: 9.9(1984-95), 15(1984-95)

18-1830
DAMPER RETÉN AGUA

Reemplaza: 663-44366-00
Para: 25 ML, MS(1997-02), 30(1987-01), 40(1984-05), 50(1986-09), 60(2001-05), 70(1984-09), 90(1984-09), B90(1997-99), C30(1995), C40(1991-01), C50(1998-01), C55(1991-95), C60(1996-01), C70(2000-01), C75(1994-99), C80(1997), C85(1991-96), C90(1997-01), E48(1995-00), E60(1995-00), E75(1995-00), F30(2001-05, 2013), F40(1999-13), F50(1995-13), F60(2002-13), F70(2010-13), F75(2003-11), F80(1999-03), F90(2003-13), F100(1999-03), F200(2002-12), F225(2002-12), F250(2005-12), L225(1994-99), L250(1990-99), LF200(2002-12), LF225(2002-10), LF250(2005-12), LX225(2000-03), LX250(2000-03), LZ250(2003-05), LZ300(2004-06), P40(1998), P50(1991-96), P60(1991-99), P75(1996-99), S225(1996-99), S250(1996-99), SX225(2000-03), SX250(2000-03), T25(2001-13), T50(1996-13), T60(2003-13), V200(1998-99), V225(1998-99), VX200(2000-05), VX225(2000-04), VX250(2002-04), VZ200(2005-09), VZ225(2005-09), VZ250(2003-09), VZ300(2004-09), Z250(2003-05), Z300(2004-06)





18-1833
DAMPER RETÉN
Reemplaza: 647-44366-00
Para: 6(1986-00), 8(1984-00), 9.9(1996-09), 15(1996-09), F9.9(2005-06), F15(1998-06), T9.9(2005-06)



18-1834
DAMPER RETÉN AGUA
Reemplaza: 682-44365-00
Para: 6(1986-00), 8(1984-00), 9.9(1996-09), 15(1996-09), F9.9(2005-06), F15(1998-06), T9.9(2005-06)



18-3505
DAMPER RETÉN AGUA
Reemplaza: 63V-44365-10-00
Para: 2-tiempos: 9.9hp & 15hp 1997-Actual
4-tiempos: F6 & F/T8 2001-Actual: F/T 9.9 2005-Actual; F15 1998-Actual



18-3166
DAMPER RETÉN AGUA
Reemplaza: 6E0-44366-00-00
Para: 2 (1984-85, 88-99, 2002), 3 (1988-99, 02), 4 (1984-85, 88-99), 5 (1984-85, 95-02), F2.5 (2003-05)



18-3176
DAMPER RETÉN AGUA
Reemplaza: 68T-44366-00-00
Para: F6, F8 (2001-05), C30 (1993-97)



18-9075
ESPACIADOR
Reemplaza: 61A-45538-00-00
Para: 2-tiempos: 115hp.-300hp.(1993-Actual), 4-tiempos: 115hp.-225hp.(2002-Actual)



18-9076
COLLAR
Reemplaza: 61A-45527-00-00
Para: 2-tiempos: 115hp.-300hp. 1993-Actual), 4-tiempos: 115hp.-225hp.(2002-Actual)



18-9077
ARANDELA
Reemplaza: 90206-22M19
Para: 2-tiempos: 115hp.-300hp.(1993-Actual), 4-tiempos: 115hp.-225hp.(2002-Actual)



18-9078
ARANDELA ACERO INOX
Reemplaza: 90201-22M01
Para: 2-tiempos: 115hp.-300hp.(1993-Actual), 4-tiempos: 115hp.-225hp.(2002-Actual)



18-9079
KIT ARANDELA
Para: Yamaha 2-tiempos115-300hp (1993 & Sup); Yamaha 4-tiempos 115-225hp (2002 & Sup); Mercury 4-tiempos 225 EFI S/N 0T653945 & Sup



18-3148
KIT BOMBA DE AGUA
Sin alojamiento
Reemplaza: 682-W0078-A1-00
— CONTIENE —



18-3397
KIT BOMBA DE AGUA
Sin alojamiento
Reemplaza: 679-W0078-00-00, 679-W0078-A0-00
— CONTIENE —

Ref #	Descripción	O.E.#	Cant.
18-0768	Junta	682-44315-A0-00	1
18-3074	Impulsor	682-44352-01-00	1
18-3305	Chaveta	90280-03024	1

Ref #	Descripción	O.E. #	Cant.
18-3088	Impulsor	6F5-44352-00	1
18-3300	Chaveta	90280-04M00-00	1
18-0256	Tornillo	97395-08045-00	2















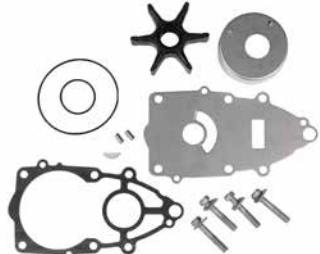





18-3408
KIT BOMBA COMBUSTIBLE CON ALOJAMIENTO
Reemplaza: 6H4-W0078-00, A0, 663-44311-02
Para: 40(1984-87), 50(1984-87), Pro50(1987)



18-3409
KIT BOMBA AGUA CON ALOJAMIENTO
Reemplaza: 67F-W0078-00, 67F-44311-01
Para: F75(2006-10), F80(1999-03), F90(2006-10), F100(1999-03)



18-3410
KIT BOMBA AGUA CON ALOJAMIENTO
Reemplaza: 68T-W0078-00, 63V-44301-00
Para: F6(01-08), F8(01-09), F9.9(07-09)

 <p>18-3411 KIT BOMBA DE AGUA CON ALOJAMIENTO Reemplaza: 682-W0078-A1, 682-44300-01 Para: 9.9(1984-95), 15(1984-95), F9.9(1985-96), FT9.9(1985-90), T9.9(1991-96)</p>	 <p>18-3412 KIT BOMBA DE AGUA CON ALOJAMIENTO Reemplaza: 63V-W0078-01, 63V-44301-00 Para: 9.9(1996-09), 15(1996-09), F9.9(2005-06), F15(1998-05), T9.9(2005-06)</p>	 <p>18-3516 KIT BOMBA DE AGUA CON ALOJAMIENTO Reemplaza: 60X-W0078-00-00 Para: VZ200 (3.3L) 2005-2010, VZ225 (3.3L) 2003-2010, VZ250 (3.3L) 2003-2010, VZ300 (3.3L) 2005-2010</p>	
 <p>18-3442 KIT REPARACIÓN BOMB. DE AGUA Reemplaza: 68V-W0078-00-00 Para: F115 2002-2010 / LF115 2002-2010</p>	 <p>18-3515 KIT BOMBA REPARACIÓN Reemplaza: 6P2-W0078-00-00 Para: F225 fabricado antes 04/2007 / F250 fabricado antes 4/2006</p>	 <p>18-3461 KIT BOMBA AGUA CON ALOJAMIENTO Reemplaza: 6H3-W0078-00-00, A0, 6H3-44311-00 Para: 70(1984-91), P60(1991), T50(1996)</p>	
 <p>18-3466 KIT BOMBA AGUA CON ALOJAMIENTO Reemplaza: 6H3-W0078-01, 6H3-44311-00 Para: 70(1992-03), C60(1996-01), E60(1995-96), P60(1992-99), C70(2000-01), T50(1997-10), T60(2003-10)</p>	 <p>18-3522-1 KIT BOMBA AGUA CON ALOJAMIENTO Reemplaza: 60X-W0078-00, 61A-44311-01 Para: VZ200(2005-09), VZ225(2003-09), VZ250(2003-09), VZ300(2004-09)</p>	 <p>18-3523-1 KIT BOMBA AGUA CON ALOJAMIENTO Reemplaza: 68V-W0078-00, 61A-44311-01 Para: F115 & LF115 (2002 & Sup)</p>	 <p>18-48619 KIT COMPLETO BOMBA DE AGUA Reemplaza: 68D-WG078-00-00 Para: Yamaha F4(2002-08)</p>
 <p>18-3432 KIT BOMBA DE AGUA Reemplaza: 61N-W0078-11-00 Para: F25(1998-05)</p>	 <p>18-3450 KIT BOMBA AGUA Reemplaza: 68T-W0078-00-00 Para: F6, F8 (2001-05)</p>	 <p>18-3451 KIT BOMBA AGUA Reemplaza: 67F-W0078-00-00 Para: F75 (2003-06), F80(1999-03), F90(2003-04), F100(1999-02)</p>	 <p>18-3460 KIT BOMBA AGUA Reemplaza: 6N0-W0078-A0-00, 6G1-W0078-A1-00, 6G1-W0078-01-00 Para: 6(1986-00), 8(1984-05)</p>
 <p>18-3462 KIT BOMBA DE AGUA Reemplaza: 6A1-W0078-02-00 Para: 2(1988-02)</p>	 <p>18-3463 KIT BOMBA DE AGUA Reemplaza: 6A1-W0078-01-00 Para: 2(1984-87)</p>	 <p>18-3464 KIT BOMBA AGUA Reemplaza: 6H3-W0078-01-00 Para: C60(1996), E60(1995-96), P60(1992-96), 70(1992-96)</p>	 <p>18-3465 KIT BOMBA AGUA Reemplaza: 6H3-W0078-02-00 Para: T50(1997-05), 60(2001-03), C60(1997-01), C70(2000-01), P60(1997-99), T60(2003-05), 70(1997-03)</p>

18-3310
KIT BOMBA AGUA
 Sin alojamiento
 Reemplaza: 6G5-W0078-01-00



-- CONTIENE --

Ref #	Descripción	O.E. #	Cant.
18-3071	Impulsor	6E5-44352-00	1
18-3345	Platina impulsor	6G5-44323-00	1
18-3302	Chaveta	90280-04M05-00	1
18-0244	Junta bomba agua	6E5-44315-A0-00	1
18-0256	Tornillo	97395-08045-00	4
18-7483	Aro	93210-37M67-00	1
18-7485	Aro	93210-86M38-00	1

18-3311
KIT BOMBA DE AGUA
 Sin alojamiento
 Reemplaza: 6G5-W0078-A1-00



-- CONTIENE --

Ref #	Descripción	O.E. #	Cant.
18-3170	Alojamiento bomba de agua	6E5-44311-00	1
18-3071	Impulsor	6E5-44352-00	1
18-3345	Platina impulsor	6G5-44323-00	1
18-3302	Chaveta	90280-04M05-00	1
18-0244	Junta bomba de agua	6E5-44315-A0-00	1
18-0256	Tornillo	97395-08045-00	4
18-7483	Aro	93210-37M67-00	1
18-7485	Aro	93210-86M38-00	1

18-3312
KIT BOMBA DE AGUA
 Sin alojamiento
 Reemplaza: 6N6-W0078-00-00



-- CONTIENE --

Ref #	Descripción	O.E. #	Cant.
18-3302	Chaveta	90280-04M05-00	1
18-3333	Alojamiento impulsor	61A-44322-00	1
18-3071	Impulsor	6E5-44352-00	1
18-3344	Platina impulsor	6E5-44323-00	1
18-0244	Junta bomba de agua	6E5-44315-A0-00	1
18-0256	Tornillo	97395-08045-00	4
18-7483	Aro	93210-37M67-00	1
18-7485	Aro	93210-86M38-00	1

18-3313-1
KIT BOMBA DE AGUA
 Sin alojamiento
 Reemplaza: 6N6-W0078-01-00



-- CONTIENE --

Ref #	Descripción	O.E. #	Cant.
18-3173-1	Alojamiento bomba agua	61A-44311-00	1
18-3302	Chaveta	90280-04M05-00	1
18-3333	Alojamiento impulsor	61A-44322-00	1
18-3071	Impulsor	6E5-44352-00	1
18-3344	Platina impulsor	6E5-44323-00	1
18-0244	Junta bomba agua	6E5-44315-A0-00	1
18-0256	Tornillos	97395-08045-00	4
18-7483	Aros	93210-37M67-00	1
18-7485	Aros	93210-86M38-00	1

18-3370
KIT BOMBA AGUA
 Sin alojamiento
 Reemplaza: 692-W0078-00-00, 692-W0078-01-00,
 692-W0078-A0-00



-- CONTIENE --

Ref #	Descripción	O.E. #	Cant.
18-3301	Chaveta	90280-04M04-00	1
18-3070	Impulsor	688-44352-03	1
18-0239	Junta	688-44315-A0-00	1
18-0240	Junta	688-44316-A0-00	1
18-7436	Aro	93210-46044-00	1

18-3371
KIT BOMBA DE AGUA
 Con alojamiento
 Reemplaza: 692-W0078-A0-00



-- CONTIENE --

Ref #	Descripción	O.E. #	Cant.
18-3171	Bomba agua alojamiento	688-44311-01	1
18-3301	Chaveta	90280-04M04-00	1
18-3070	Impulsor	688-44352-03	1
18-0239	Junta	688-44315-A0-00	1
18-0240	Junta	688-44316-A0-00	1
18-7436	Aro	93210-46044-00	1

18-3372
KIT BOMBA DE AGUA
 Sin alojamiento
 Reemplaza: 6E5-W0078-01-00



-- CONTIENE --

Ref #	Descripción	O.E. #	Cant.
18-3302	Chaveta	90280-04M05-00	1
18-3071	Impulsor	6E5-44352-00	1
18-3344	Platina impulsor	6E5-44323-00	1

18-3373
KIT BOMBA AGUA
 Con alojamiento
 Reemplaza: 6E5-W0078-A1-00



-- CONTIENE --

Ref #	Descripción	O.E. #	Cant.
18-3170	Junta bomba alojamiento	6E5-44311-00-00	1
18-3302	Chaveta	90280-04M05-00	1
18-3071	Impulsor	6E5-44352-00	1
18-3344	Platina impulsor	6E5-44323-00	1
18-0244	Junta bomba combustible	6E5-44315-A0-00	1
18-0256	Tornillo	97395-08045-00	4
18-7483	Aro	93210-37M67-00	1
18-7485	Aro	93210-86M38-00	1



**18-3374
KIT BOMBA AGUA**

Sin alojamiento

Reemplaza: 6F5-W0078-00-00, 6F5-W0078-A0-00
— CONTIENE —

Ref #	Descripción	O.E. #	Cant.
18-3300	Chaveta	90280-04M00-00	1
18-3088	Impulsor	6F5-44352-00	1
18-0256	Tornillo	97395-08045-00	2



**18-3398
KIT BOMBA AGUA**

Con alojamiento

Reemplaza: 6F5-W0078-A0-00, 6F5-W0078-00-00
— CONTIENE —

Ref #	Descripción	O.E. #	Cant.
18-3088	Impulsor	6F5-44352-00	1
18-3300	Chaveta	90280-04M00-00	1
18-0256	Tornillo	97395-08045-00	2



**18-3395
KIT BOMBA AGUA**

Sin alojamiento

Reemplaza: 61A-W0078-01-00
— CONTIENE —

Ref #	Descripción	O.E. #	Cant.
18-3071	Impulsor	6E5-44352-00	1
18-3345	Platina impulsor	6G5-44323-00	1
18-3302	Chaveta	90280-04M05-00	1
18-3333	Alojamiento impulsor	61A-44322-00	1
18-0244	Junta bomba de agua	6E5-44315-A0-00	1
18-0256	Tornillo	97395-08045-00	4
18-7483	Aro	93210-37M67-00	1
18-7485	Aro	93210-86M38-00	1



**18-3396-1
KIT BOMBA AGUA**

Con alojamiento

Reemplaza: 61A-W0078-A2-00, 61A-W0078-A3-00
— CONTIENE —

Ref #	Descripción	O.E. #	Cant.
18-3173-1	Alojamiento bomba agua	61A-44311-00	1
18-3071	Impulsor	6E5-44352-00	1
18-3345	Platina impulsor	6G5-44323-00	1
18-3302	Chaveta	90280-04M05-00	1
18-3333	Alojamiento impulsor	61A-44322-00	1
18-0244	Junta bomba agua	6E5-44315-A0-00	1
18-0256	Tornillo	97395-08045-00	4
18-7483	Aro	93210-37M67-00	1
18-7485	Aro	93210-86M38-00	1



**18-3425
KIT BOMBA DE AGUA**

Sin alojamiento

Reemplaza: 663-W0078-00-00, 663-W0078-A0-00
— CONTIENE —

Ref #	Descripción	O.E. #	Cant.
18-0292	Platina	663-44315-A0-00-00	1
18-3435	Alojamiento impulsor	663-44322-00-00	1
18-0294	Platina	663-44324-A0-00-00	1
18-3069	Impulsor	6H3-44352-00-00	1
18-0256	Tornillo	97395-08045-00	2
18-3436	Impulsor platina	663-44323-00-00	1
18-3297	Llave impulsor	90280-03M03-00	1



**18-3426
KIT BOMBA AGUA**

Con alojamiento

Reemplaza: 689-W0078-04-00, 689-W0078-A4-00
— CONTIENE —

Ref #	Descripción	O.E. #	Cant.
18-3067	Impulsor	689-44352-02-00	1
18-3294	Llave impulsor	—	1



**18-3434
KIT BOMBA AGUA**

Sin alojamiento

Reemplaza: 63D-W0078-01-00, 63D-44311-00-00
Para: 40/50(1995-03), P40(1998), C40 3 cyl(1997-02), C50(1999-01), F40 2.6L(1999), F50(1995-03), P50 (1995-96), F60(2002-03)
Para kit con alojamiento, 18-3415



**18-3415
KIT BOMBA AGUA**

Con alojamiento

Reemplaza: 63D-W0078-01-00, 63D-44311-00-00
Para: 40/50(1995-03), P40(1998), C40 3 cyl(1997-02), C50(1999-01), F40 2.6L(1999), F50(1995-03), P50 (1995-96), F60(2002-03)
Para kit sin alojamiento, 18-3434



18-3440
KIT BOMBA AGUA
 Sin alojamiento
Reemplaza: 66T-W0078-00-00
Para: T25 (2001-04), F30 (2001-04), F40 (2000-04)



18-3413
KIT BOMBA AGUA
 Con alojamiento
Reemplaza: 66T-W0078-00, 66T-44311-00
Para: F30(2001-05), F40(2000-08), T25 (2001-06)
 Para kit sin alojamiento, 18-3440



18-3428-1
KIT BOMBA AGUA
 Sin alojamiento
Reemplaza: 6H3-W0078-00-00, 6H3-W0078-A0-00
 — CONTIENE —

Ref #	Descripción	O.E. #	Cant.
18-0240	Junta bomba agua	688-44316-A0-00	1
18-3069	Impulsor	6H3-44352-00-00	1
18-7436	Aro	93210-46044-00	1
18-0256	Tornillo	97395-08045-00	2
18-0756-1	Junta bomba agua	6H3-44315-A0-00	1
18-0757	Junta platina	6H3-44324-A0-00	1



18-3429
KIT BOMBA DE AGUA
 Sin alojamiento
Reemplaza: 6H4-W0078-00-00, 6H4-W0078-A0-00
 — CONTIENE —

Ref #	Descripción	O.E. #	Cant.
18-0292	Junta montaje	688-44315-A0-00	1
18-3435	Alojamiento impulsor	663-44322-00-00	1
18-0294	Junta platina desgaste a base bomba	663-44324-A0-00	1
18-3068	Impulsor	6H4-44352-02-00, 6H4-44352-00-00	1
18-0256	Tornillo	97395-08045-00	2
18-3436	Impulsor platina	663-44323-00-00	1



18-3430
KIT REPARACIÓN BOMBA DE AGUA
 Sin alojamiento
Reemplaza: 6J8-W0078-A1-00
 — CONTIENE —

Ref #	Descripción	O.E. #	Cant.
18-0292	Junta	688-44315-A0-00	1
18-3435	Alojamiento	663-44322-00-00	1
18-0294	Junta platina desgaste a bomba agua	663-44324-A0-00	1
18-3068	Impulsor	6H4-44352-02-00, 6H4-44352-00-00	1
18-0256	Tornillo	97395-08045-00	2
18-3436	Platina	663-44323-00-00	1



18-3431
KIT BOMBA AGUA
 Sin alojamiento
Reemplaza: 6L2-W0078-00-00
 — CONTIENE —

Ref #	Descripción	O.E. #	Cant.
18-3065	Impulsor	6L2-44352-00-00	1
18-7483	Aro	93210-37M67-00	1



18-3427
KIT BOMBA AGUA
 Con alojamiento
Reemplaza: 689-W0078-A6-00
 — CONTIENE —

Ref #	Descripción	O.E. #	Cant.
18-3294	Llave impulsor	—	1
18-3067	Impulsor	689-44352-02-00	1



18-3433
KIT BOMBA AGUA
 Sin alojamiento
Reemplaza: 63V-W0078-01-00
Para: 9.9/15(1996-04), F15 (1998-04)

HP/Modelo	Año	Impulsor	Alojamiento imp.	Platina	Alojamiento	kit con alojamiento	Kit sin alojamiento
MODELOS 4 TIEMPOS							
F4	1999-01	18-3073					
F4	2002-11	18-3073				—	—
F6	2001-08	18-8910	18-3444	18-3142	18-3356	18-3410	18-3450
F6	2009-11	18-3073	—	—	—	—	—
F8	2001-11	18-8910	18-3444	18-3142	18-3356	18-3410	18-3450
T8	2001-10	18-3040	18-3444	18-3142	—	—	—
F9.9	1985-04	18-3074	—	—	—	18-3411	18-3148
F9.9	2005-06	18-3040	18-3444	18-3195	18-3356	18-3412	18-3433
F9.9	2007-11	18-8910	18-3444	18-3142	18-3356	18-3410	18-3450
FT9.9	1985-90	18-3074	—	—	—	18-3411	18-3148
T9.9	1991-96	18-3074	—	—	—	18-3411	18-3148
T9.9	2005-06	18-3040	18-3444	18-3195	18-3356	18-3412	18-3433
F15	1998-05	18-3040	18-3444	18-3195	18-3356	18-3412	18-3433
F15	2006-11	18-3040	18-3444	18-3142	—	—	—
F25	1998-05, 2009-11	18-3068	18-3443	18-3194	18-3185	18-3432	—
T25	2001-06, 2009	18-3068	18-3449	18-3196	—	18-3413	18-3440
F30	2001-05	18-3068	18-3449	18-3196	—	18-3413	18-3440
F40	1999	18-3069	18-3449	18-3186	—	18-3415	18-3434
F40	2000-08	18-3068	18-3449	18-3196	—	18-3413	18-3440
F40 2.6L	1999	18-3069	18-3449	18-3186	—	—	18-3434
F50	1995-09	18-3069	18-3449	18-3186	—	18-3415	18-3434
T50	1996	18-3069	18-3435	—	—	18-3461	18-3428-1
T50	1997-11	18-3069	18-3435	—	—	18-3466	18-3465
F60	2002-09	18-3069	18-3449	18-3186	—	18-3415	18-3434
T60	2003-11	18-3069	18-3435	—	—	18-3466	18-3465
F75	2003-11	18-3042	18-3162	18-3143	—	18-3409	18-3451
F80	1999-03	18-3042	18-3162	18-3143	—	18-3409	18-3451
F90	2003-11	18-3042	18-3162	18-3143	—	18-3409	18-3451
F100	1999-03	18-3042	18-3162	18-3143	—	18-3409	18-3451
F115/LF115	2000-11	18-3071	18-3519	18-3521	18-3173-1	—	18-3442
F150 / LF150	2004-11	18-3071	18-3519	18-3345	18-3173-1	18-3396-1	18-3395
F200/LF200	2002-11	18-3071	18-3519	18-3345	18-3173-1	18-3396-1	18-3395
VF200	2009-11	18-3071	18-3519	—	18-3173-1	—	—
F225/LF225	2002-10	18-3071	18-3519	18-3345	18-3173-1	18-3396-1	18-3395
F225/LF225	* 2007-09	18-3071	18-3519	18-3518	18-3173-1	—	18-3515
VF225	2009-11	18-3071	18-3519	—	18-3173-1	—	—
F250 / LF250	** 2005	18-3071	18-3519	18-3345	18-3173-1	18-3396-1	18-3395
F250 / LF250	** 2006-11	18-3071	18-3519	18-3518	18-3173-1	—	18-3515
VF250	2009-10	18-3071	18-3519	—	18-3173-1	—	18-3515
F300	2007-10	—	—	—	—	—	—
LF300	2007-10	—	—	—	—	—	—
Z300							18-3515
F350	2007-10	—	—	—	—	—	—
LF350	2007-10	—	—	—	—	—	—

MODELOS 2-TIEMPOS

HP/Modelo	Año	Impulsor	Impulsor aloj.	Platina	Alojamiento	Kit con alojamiento	Kit sin alojamiento
2	1984-87	18-3072	18-3328	18-3357	—	18-3463	—
2	1988-02	18-3072	18-3328	18-3357	—	18-3462	—
4	1984-99	18-3073				—	—
5	1984-02	18-3073				—	—
6	1986-00	18-3066	18-3456		—	—	18-3460
8	1984-09	18-3066	18-3456		—	—	18-3460
9.9	1984-95	18-3074				18-3411	18-3148
9.9	1996-09	18-3040	18-3444	18-3195		18-3412	18-3433
15	1984-95	18-3074				18-3411	18-3148
15	1996-09	18-3040	18-3444	18-3195		18-3412	18-3433
20	1996-97	18-3065			—	—	18-3431
25	1984-85	18-3067				18-3426	—
25	1986-87	18-3067				18-3427	—
25 (2 cil)	1988-09	18-3065			—	—	18-3431
25 (3 cil)	1996-02	18-3068	—	—	—	—	—
C25	1990-97	18-3067				18-3427	—
CV25	1990	18-3067				18-3427	—
30	1984-85	18-3067				18-3426	—
30	1986	18-3067				18-3427	—
30	1987-01	18-3068	18-3435	18-3436	—	—	18-3430
C30	1990-92	18-3067				18-3427	—
C30	1993-97	18-3068	18-3443	18-3194	18-3185	18-3432	—
40	1984-87	18-3068	18-3435	18-3436	—	18-3408	18-3429
40	1988-94	18-3068	18-3435	18-3436	—	—	18-3429
40	1995-05	18-3069	18-3449	18-3186		18-3415	18-3434
C40	1990-91	18-3088	—	—	—	18-3375	18-3374
C40	1992-97	18-3088	—	—	—	18-3398	18-3397
C40	1997-03	18-3069	18-3449	18-3186		18-3415	18-3434
P40	1998	18-3069	18-3449	18-3186		18-3415	18-3434
50	1984-87	18-3068	18-3435	18-3436	—	18-3408	18-3429
50	1988-94	18-3068	18-3435	18-3436	—	—	18-3429
50	1995-09	18-3069	18-3449	18-3186		18-3415	18-3434
C50	1998-01	18-3069	18-3449	18-3186		18-3415	18-3434
PRO 50	1987	18-3068	18-3435	18-3436	—	18-3408	18-3429
PRO 50	1988-90	18-3068	18-3435	18-3436	—	—	18-3429

① 2.6L motor ② 3.1L motor * modelos con eje 20" ** excluye 4.2L

HP/Modelo	Año	Impulsor	Alojamiento imp.	Platina	Alojamiento	Kit con alojamiento	Kit sin alojamiento
P50	1991-93	18-3068	18-3435	18-3436	--	--	18-3429
P50	1995-96	18-3069	18-3449	18-3186	--	--	18-3434
50 Jet	1986-89	18-3068	--	--	--	--	--
C55	1991-94	18-3069	18-3435	18-3436	--	--	18-3425
CV55	1989	18-3069	18-3435	18-3436	--	--	18-3425
60	2001-03	18-3069	18-3435	--	--	--	18-3465
60	2004-05	18-3070	--	--	18-3171	18-3371	18-3370
C60	1996-01	18-3069	18-3435	--	--	18-3466	18-3465
E60	1995-96	18-3069	18-3435	--	--	18-3466	18-3465
E60	1997-00	18-3069	--	--	--	--	--
P60	1991	18-3069	18-3435	--	--	18-3461	18-3428-1
P60	1992-99	18-3069	18-3435	--	--	18-3466	18-3465
70	1984-91	18-3069	18-3435	--	--	18-3461	18-3428-1
70	1992-03	18-3069	18-3435	--	--	18-3466	18-3465
70	2004-09	18-3070	--	--	18-3171	18-3371	18-3370
C70	2000-01	18-3069	18-3435	--	--	18-3466	18-3465
C75	1994-99	18-3070	--	--	18-3171	18-3371	18-3370
E75	1995-00	18-3070	--	--	--	--	--
P75	1996-99	18-3070	--	--	--	--	--
C80	1997	18-3070	--	--	--	--	--
85	1985	18-3070	--	--	--	--	--
C85	1989-97	18-3070	--	--	18-3171	18-3371	18-3370
CV85	1989-91	18-3070	--	--	18-3171	18-3371	18-3370
90	1984-09	18-3070	--	--	18-3171	18-3371	18-3370
90 Jet	1986-89	18-3070	--	--	--	--	--
B90	1997-99	18-3070	--	--	--	--	--
C90	1997-01	18-3070	--	--	18-3171	18-3371	18-3370
C115	1991-92	18-3071	--	18-3344	18-3170	18-3373	18-3372
C115	1993-96	18-3071	18-3333	18-3344	18-3173-1	18-3313-1	18-3312
C115	1997-00	18-3071	--	18-3344	--	--	--
P115 (62A)	1993-96	18-3071	18-3333	18-3344	18-3173-1	18-3313-1	18-3312
115 (6N6), (6E5)	1984-94	18-3071	--	18-3344	18-3170	18-3373	18-3372
115 (6N6)	1994	18-3071	18-3333	18-3344	18-3173-1	18-3313-1	18-3312
130 (6L1), (6N7)	1988-92	18-3071	--	18-3344	18-3170	18-3373	18-3372
130 (6N7)	1993-96	18-3071	18-3333	18-3344	18-3173-1	18-3313-1	18-3312
130	1997-01	18-3071	--	18-3344	--	--	--
130	2002-04	--	--	18-3344	--	--	--
L130 (6L6), (6N4)	1989-92	18-3071	--	18-3344	18-3170	18-3373	18-3372
L130 (6N4)	1993-96	18-3071	18-3333	18-3344	18-3173-1	18-3313-1	18-3312
L130	1997-01	18-3071	--	18-3344	--	--	--
C150 (6E5)	1996-99	18-3071	18-3333	18-3345	18-3173-1	18-3396-1	18-3395
150 (6R2), (6G4)	1984-91	18-3071	--	18-3344	18-3170	18-3311	18-3310
150 (6R2)	1992-09	18-3071	18-3333	18-3345	18-3173-1	18-3396-1	18-3395
L150 (6R0), (6K0)	1986-91	18-3071	--	18-3344	18-3170	18-3311	18-3310
L150 (6R0)	1992-99	18-3071	18-3333	18-3345	18-3173-1	18-3396-1	18-3395
P150	1986-91	18-3071	--	18-3344	18-3170	18-3311	18-3310
P150	1992-99	18-3071	18-3333	18-3345	18-3173-1	18-3396-1	18-3395
150/175/200ETLN	1984	18-3071	--	18-3344	18-3170	18-3311	18-3310
PRO V150 (6J9)	1986-89	18-3071	--	18-3344	18-3170	18-3311	18-3310
PRO V150D (6N9)	1990	18-3071	--	18-3344	18-3170	18-3311	18-3310
PX150	1999	18-3071	18-3333	18-3345	18-3173-1	18-3396-1	18-3395
SX150	1999-04	18-3071	18-3333	18-3345	18-3173-1	18-3396-1	18-3395
V150	2000-08	18-3071	18-3333	18-3345	18-3173-1	18-3396-1	18-3395
VZ150	2001-09	18-3071	18-3333	18-3345	18-3173-1	18-3396-1	18-3395
Z150/LZ150	2001-05	18-3071	18-3333	18-3345	18-3173-1	18-3396-1	18-3395
175 (6G5)	1984-91	18-3071	--	18-3344	18-3170	18-3311	18-3310
175 (6R3)	1992-00	18-3071	18-3333	18-3345	18-3173-1	18-3396-1	18-3395
P175 (62H)	1994-99	18-3071	18-3333	18-3345	18-3173-1	18-3396-1	18-3395
VZ175	2001-09	18-3071	18-3333	18-3345	18-3173-1	18-3396-1	18-3395
Z175	2001-05	18-3071	18-3333	18-3345	18-3173-1	18-3396-1	18-3395
200 (6G6), (6R4)	1984-91	18-3071	--	18-3344	18-3170	18-3311	18-3310
200 (6R4)	1992-99	18-3071	18-3333	18-3345	18-3173-1	18-3396-1	18-3395
L200 (6K1), (6R1)	1986-91	18-3071	--	18-3344	18-3170	18-3311	18-3310
L200	1992-99	18-3071	18-3333	18-3345	18-3173-1	18-3396-1	18-3395
LX200	1999-02	18-3071	18-3333	18-3345	18-3173-1	18-3396-1	18-3395
P200	1991-99	18-3071	18-3333	18-3345	18-3173-1	18-3396-1	18-3395
SX200	1999-05	18-3071	18-3333	18-3345	18-3173-1	18-3396-1	18-3395
V200	1998-99	18-3071	18-3333	18-3345	18-3173-1	18-3396-1	18-3395
VZ200	2001-04	18-3071	18-3333	18-3345	18-3173-1	18-3396-1	18-3395
VZ200	2005-09	18-3071	18-3519	18-3520	18-3173-1	--	18-3516
Z200/LZ200	2000-10	18-3071	18-3333	18-3345	18-3173-1	18-3396-1	18-3395
V6 Special (6G7)	1984-86	18-3071	--	18-3344	18-3170	18-3311	18-3310
V6 Excel (6K7)	1987-89	18-3071	--	18-3344	18-3170	18-3311	18-3310
225 (6R5)	1990-91	18-3071	--	18-3344	18-3170	18-3311	18-3310
225	1992-97	18-3071	18-3333	18-3345	18-3173-1	18-3396-1	18-3395
225/L225/S225	1994-99	18-3071	18-3333	18-3345	18-3173-1	18-3396-1	18-3395
LX225/SX225	2000-03	18-3071	18-3333	18-3345	18-3173-1	18-3396-1	18-3395
V225	1998-99	18-3071	18-3333	18-3345	18-3173-1	18-3396-1	18-3395
VX225	2000-04	18-3071	18-3333	18-3345	18-3173-1	18-3396-1	18-3395
VZ225	2003-09	18-3071	18-3519	18-3520	18-3173-1	--	18-3516
250/L250	1990-96	18-3071	18-3333	18-3345	18-3173-1	18-3396-1	18-3395
L250/S250	1997-99	18-3071	18-3333	18-3345	18-3173-1	18-3396-1	18-3395
VX250	2002-04	18-3071	18-3333	18-3345	18-3173-1	18-3396-1	18-3395
VZ250	2003-09	18-3071	18-3519	18-3520	18-3173-1	--	18-3516
Z300	2006	18-3071	18-3519	--	18-3173-1	--	18-3515
LZ300	2006	18-3071	18-3519	--	18-3173-1	--	18-3515
VZ300	2004-09	18-3071	18-3519	18-3520	18-3173-1	--	18-3516

① 2.6L motor

② 3.1L motor

* modelos con eje 20"

** excluye 4.2L

NEW



**18-3524
TERMOSTATO**

Reemplaza: 6CE-12411-00-00
Para: F225/LF225 (2010-2016), F250/LF250 (2010-2016), VF250 (2015), F300/LF300 (2010-2016), FL250/FL300 (2010)

50°C



**18-3525
TERMOSTATO**

Reemplaza: 60V-12411-00
Para: F115(2005-14), LF115(2005-14), LZ250(2003-05), LZ300(2004-06), VZ200(2005-09), VZ225(2005-09), VZ250(2005-09), VZ300(2005-09), Z250(2003-05), Z300(2004-06)

60°C



**18-3625
TERMOSTATO**

(Retén incluido)
Reemplaza: 6F5-12411-03-00
9.9EL, 9.9ES, 15EL, 15ES (1986-1995), 9.9L, 9.9S, 15L, 15S (1986-1990), 9.9M, 15ML, 15MS, C55EL (1991-1995), C25EL, C40EL (1991-1997), C25ML (1993-1997), C25MS, C40MS, C40PL (1992-1997), C30EL (1991-1992), CV30EL (1989-1990), C40ML (1994-1995), C55TL (1993-1995), CV25EL, CV25EM, CV40EL (1990), CV55EL (1989)

50°C



**18-3623
TERMOSTATO**

(Retén Incluido)
Reemplaza: 6E5-12411-02-00
8MSH-0405, 8MSH-0406, 8MSH-0407, 8MSH-0608, 8MSHD-2005

60°C



**18-3632
TERMOSTATO**

Reemplaza: 67F-12411-01-00
Para: F75-F250 (2005 & Sup)

50°C



**18-3540
TERMOSTATO**

Reemplaza: 6E5-12411-30-00
Para: 9.9-15 (1996-06), 20 (1996-97), 25 (1988-95), 30 3-cyl (1987-91), 40 (1986-05), C40 3-cyl (1998-02), 50 (1986-05), C50 (1998-01), P50 (1987-96), 115 (1984-05), B115 (1998-99), C115 (1991-00), P115 (1993-96), S115/S130 (1996-98), 130/L130 (1988-05), 150/175/200 (1986-05), C150 (1996-99), D150/DX150 (1997-05), L150/L200 (1986-99), LX150/LX200 (1999-01), P150 (1986-99), PX150 (1999), SX150/SX200 (1999-04), V150 (2000-05), VX150 (2000-05), VZ150/VZ175/VZ200 (2001-05), Z150/Z175/Z200 (2000-05), P200 (1991-93), V200/V225 (1998-99), VX200/VX225 (2000-05), V6 Special (1984-86), V6 Excel (1987-89), 225 2.6L (1990-97), 250/L250 2.6L (1990-95)
Nota: No encajarán 3.1 L

60°C



**18-3541
TERMOSTATO**

Reemplaza: 66M-12411-01-00
Para: F6 (2001-05), F8 (2001-05), T8 (2001-05), F9.9 (1985-05), T9.9 (1985-05), T9.9 (1991-05), F15 (1998-05), F25 (1998-05), T25 (2001-05), F30 (2001-05), F40 4 cil. (1999), F40 3 cil. (2000-05), F50 (1995-05), T50 (1996-05), F60 (2002-05), T60 (2003-05), F80 (1999-00), F100 (1999-00)

50°C



**18-3622
KIT TERMOSTATO**

Reemplaza: 6H3-12411-11-00
60TLR-0405, 70TLR-0405, 70TLR-0406, 70TLR-0407, 70TLR-0408

50°C



**18-3624
KIT TERMOSTATO**

Reemplaza: 69M-12411-01-00
F2.5MSH-0405, F2.5MSH-0406, F2.5MSH-0407, F2.5MSH0608, F2.5MSHD-2005

① 18-3608D



**18-3608
KIT TERMOSTATO**

Para: 115 (1991-02), C115 (1991-99), P115 (1993-96), S115 (1996-99), 130 (1991-02), L130 (1991-00), S130 (1996-99), 150 (1991-02), C150 (1996-99), L150 (1991-99), P150 (1991-99), S150 (1996-99), V150 (2000-02), Z150 (2001-02), 175 (1991-95, 97), P175 (1994-99), V175 (2000), Z175 (2001-02), 200 (1991-98), L200 (1991-99), P200 (1991-99), S200 (1996-99), V200 (1998-99), Z200 (2001-02), 225 (1991-97), V225 (1998-99)

① 18-3609D



**18-3609
KIT TERMOSTATO**

Para: 25 (1996-98, 2001-02), 40 (1991-99, 01), C40 (1997-02), P40 (1998), 50 (1991-97, 1999-02), C50 (1998-01), P50 (1991-96), L225 (1994-99), S225 (1996-99), 250 (1991-95), L250 (1991-99), S250 (1996-99)

60°C



**18-3611
KIT TERMOSTATO**

Para: 15 (2006), F15 (1998-06), F25 (1999-06), F30 (2001-06), F40 (1999-06), F50 (1996-06), F60 (2002-06), F9.9 (2005-06), T25 (2001-06), T50 (1996-06), T60 (2003-06), T9.9 (2005-06)

— CONTIENE —

Ref #	Descripción	O.E. #	Cant.
18-3540	Termostato	6E5-12411-30-00	1
18-0844	Junta	688-12414-A1-00	1

Ref #	Descripción	O.E. #	Cant.
18-0829	Junta	61A-12414-A0-00, 6J8-12414-A0-00	1

① Referencias acabadas en "D" envasadas en display

APLICACIÓN TERMOSTATO

HP/Modelo	Año	Termostato	Junta	Kit termostato	HP/Modelo	Año	Termostato	Junta	kit termostato
F2.5	2003-11	Kit sólo	18-0754	18-3624	E75	1995-00	—	18-0844	—
4	1986-88	18-3540	—	—	P75	1996-99	—	18-0844	—
4	1989-99	18-3623	—	—	C80	1997	—	18-0844	—
F4	1999-11	18-3541	18-0754	—	F80	1999-00	18-3541	—	—
5	1995-02	18-3623	—	—	90	1984-09	—	18-0844	—
6	1986-88	18-3540	—	—	90 Jet	1986-00	—	18-0844	—
6	1989-00	18-3623	—	—	B90	1997-99	—	18-0844	—
F6	2001-04	18-3541	—	—	C90	1997-01	—	18-0844	—
F6	2005-08	18-3541	—	—	F100	1999-00	18-3541	—	—
F6	2009-11	18-3541	18-0754	—	115	1984-09	18-3540	18-0844	18-3608
8	1986-88	18-3540	—	—	B115	1998-99	18-3540	18-0844	18-3608
8	1989-09	18-3623	—	—	C115	1991-00	18-3540	18-0844	18-3608
F8	2001-04	18-3541	—	—	P115	1993-96	18-3540	18-0844	18-3608
F8	2005-11	18-3541	—	—	S115	1996-99	18-3540	18-0844	18-3608
T8	2001-04	18-3541	—	—	130	1988-04	18-3540	18-0844	18-3608
T8	2005-10	18-3541	—	—	L130	1989-01	18-3540	18-0844	18-3608
9.9	1986-95	18-3625	18-0836	—	S130	1996-99	18-3540	18-0844	18-3608
9.9	1996-09	18-3540	18-0836	—	C150	1996-99	18-3540	18-0844	18-3608
F9.9	1985-11	18-3541	—	—	150	1984	—	18-0844	—
FT9.9	1985-90	18-3541	—	—	150	1985	18-3623	18-0844	—
T9.9	1991-04, 2007-11	18-3541	—	—	150	1986-09	18-3540	18-0844	18-3608
T9.9	2005-06	18-3541	18-0835	18-3611	D150	1997-99	18-3540	18-0844	18-3608
15	1984-85	—	18-0836	—	DX150	1999-05	18-3540	18-0844	18-3608
15	1986-95	18-3625	18-0836	—	L150	1986-99	18-3540	18-0844	18-3608
15	1996-09	18-3540	18-0836	—	LX150	1999-01	18-3540	18-0844	18-3608
F15	1998-06	18-3541	18-0835	18-3611	LZ150	2000-05	18-3540	18-0844	18-3608
20	1996-97	18-3540	18-0829	18-3609	Z150	2000-05	18-3540	18-0844	18-3608
25 (2 cil)	1984-87	—	18-0232	—	P150	1991-99	18-3540	18-0844	18-3608
25 (2 cil)	1988-09	18-3540	18-0829	18-3609	PX150	1999	18-3540	18-0844	18-3608
C25	1991-97	18-3625	18-0232	—	PRO V150	1986-90	18-3540	18-0844	18-3608
CV25	1990	18-3625	18-0232	—	S150	1996-99	18-3540	18-0844	18-3608
F25	1998-11	18-3541	18-0835	18-3611	SX150	1999-04	18-3540	18-0844	18-3608
T25	2001-11	18-3541	18-0835	18-3611	V150	2000-08	18-3540	18-0844	18-3608
30	1984-85	—	18-0232	—	VX150	2000-04	18-3540	18-0844	18-3608
30	1986	18-3625	18-0835	—	VZ150	2000-11	18-3540	18-0844	18-3608
30	1987-88	18-3540	18-0829	18-3609	175	1984	—	18-0844	—
30	1989-91	18-3623	18-0829	—	175	1985	18-3623	18-0844	—
30	1992-02	—	18-0829	—	175	1986-00	18-3540	18-0844	18-3608
C30	1991-92	18-3625	18-0232	—	P175	1994-99	18-3540	18-0844	18-3608
C30	1993-94, 1996-97	18-3623	18-0232	—	S175	1996-99	18-3540	18-0844	18-3608
F30	2001-05	18-3541	18-0835	18-3611	V175	2000	18-3540	18-0844	18-3608
40	1984-85	—	18-0829	—	VZ175	2001-10	18-3540	18-0844	18-3608
40	1986-05	18-3540	18-0829	18-3609	Z175	2001-05	18-3540	18-0844	18-3608
C40	1991-97	18-3625	—	—	200	1984	—	18-0844	—
C40	1998-03	18-3540	18-0829	18-3609	200	1985	18-3623	18-0844	—
F40	1999-11	18-3541	18-0835	18-3611	200	1986-98	18-3540	18-0844	18-3608
F40 2.6L	1999	18-3541	18-0835	18-3611	L200	1986-99	18-3540	18-0844	18-3608
P40	1998	18-3540	18-0829	18-3609	LX200	1999-01	18-3540	18-0844	18-3608
50	1984-85	—	18-0829	—	LZ200	2000-11	18-3540	18-0844	18-3608
50	1986-09	18-3540	18-0829	18-3609	P200	1991-99	18-3540	18-0844	18-3608
C50	1998-01	18-3540	18-0829	18-3609	SX200	1999-05	18-3540	18-0844	18-3608
F50	1995-11	18-3541	18-0835	18-3611	V200	1998-99	18-3540	18-0829	18-3609
PRO 50	1987-90	18-3540	18-0829	18-3609	VX200	2000-05	18-3540	18-0829	18-3609
P50	1991-96	18-3540	18-0829	18-3609	VZ200	2001-04	18-3540	18-0844	18-3608
50 Jet	1986-00	18-3540	18-0829	18-3609	Z200	2000-11	18-3540	18-0844	18-3608
T50	1996-11	18-3541	18-0835	18-3611	V6 Special	1985-86	18-3540	18-0844	18-3608
C55	1991-95	18-3625	—	—	V6 Excel	1987-89	18-3540	18-0844	18-3608
CV55	1989-90	18-3625	—	—	225	1990-97	18-3540	18-0844	18-3608
60	2001-05	Kit sólo	18-0835	18-3622	L225	1994-99	18-3540	18-0829	18-3609
C60	1996-01	Kit sólo	18-0835	18-3622	S225	1996-99	18-3540	18-0829	18-3609
E60	1995-00	Kit sólo	18-0835	18-3622	LX225	2000-03	18-3540	18-0829	18-3609
F60	2002-11	18-3541	18-0835	18-3611	SX225	2000-03	18-3540	18-0829	18-3609
P60	1991-99	Kit sólo	18-0835	18-3622	V225	1998-99	18-3540	18-0829	18-3609
T60	2003-11	18-3541	18-0835	18-3611	VX225	2000-04	18-3540	18-0829	18-3609
70	1984-09	Kit sólo	18-0835	18-3622	250	1990-95	18-3540	18-0829	18-3609
C70	2000-01	Kit sólo	18-0835	18-3622	L250	1990-99	18-3540	18-0829	18-3609
F70	2010	18-3541	18-0835	18-3611	LX250	2000-03	18-3540	18-0829	18-3609
C75	1994-99	—	18-0844	—	S250	1996-99	18-3540	18-0829	18-3609
					SX250	2000-03	18-3540	18-0829	18-3609
					VX250	2002-04	18-3540	18-0829	18-3609

**TODOS LOS PISTONES
TODOS LOS PISTONES SE SUMINISTRAN CON AROS, BULÓN Y CIERRES**



Aros pistón disponibles individualmente.

V-4 & V-6 Pistones y aros

STANDARD		
18-4128 (babor) Reemplaza: 6G5-11642-00-93	18-4129 (Estr.) Reemplaza: 6G5-11631-00-93	— CONTIENE —
Ref #	Aros	O.E. #
18-3934	Standard	6E5-11610-03-00

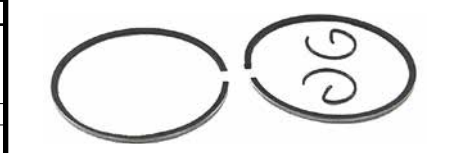

.50mm O.S.	
18-4132 (babor) Reemplaza: 6G5-11646-01-00	18-4133 (Estr.) Reemplaza: 6G5-11636-01-00

MOTORES V-6 (1992-2001)

18-4080 (babor) Reemplaza: 6R5-11642-11-93	18-4081 (Estr.) Reemplaza: 6R5-11631-11-93	— CONTIENE —
Ref #	Aros	O.E. #
18-39320	Standard	6R5-11603-00

18-4082 (babor) Reemplaza: 6R5-11645-11-00	18-4083 (Estr.) Reemplaza: 6R5-11635-11-00
---	---

18-4084 (babor) Reemplaza: 6R5-11646-11-00	18-4085 (Estr.) Reemplaza: 6R5-11636-11-00
---	---

Aros y pistones en línea

STANDARD		
18-4091	Reemplaza: 6H3-11631-01-96	— CONTIENE —
Ref #	Aros	O.E. #
18-3963	Standard	6K5-11601-02-00
18-4135	Reemplaza: 6E7-11631-00-97	— CONTIENE —
Ref #	Aros	O.E. #
18-3976	Standard	682-11610-01-00
18-4138	Reemplaza: 689-11631-00-95	— CONTIENE —
Ref #	Aros	O.E. #
18-3954	Standard	689-11610-01-00
18-4141	Reemplaza: 6H4-11631-00-96	— CONTIENE —
Ref #	Aros	O.E. #
18-3960	Standard	6H4-11610-00-00
18-4097	Reemplaza: 6H1-11631-03-95	— CONTIENE —
Ref #	Aros	O.E. #
18-3969	Standard	688-11603-A0-00

.25mm O.S.	
18-4145	Reemplaza: 61N-11635-00-00
18-4142	Reemplaza: 6H4-11635-01-00
— CONTIENE —	

.50mm O.S.	
18-4093	Reemplaza: 6H3-11636-01-00
18-4146	Reemplaza: 61N-11636-00-00
18-4143	Reemplaza: 6H4-11636-00-00
— CONTIENE —	
18-4099	Reemplaza: 6H1-11636-03-00



APLICACIÓN PISTONES

HP/Modelo	Años	PISTONES			AROS		
		Std.	.25mm	.50mm	Std.	.25mm	.50mm
9.9/15	1984-96	18-4135	—	18-4137	18-3976	—	—
9.9/15	1997-2009	18-4135	—	18-4137	18-3976	—	—
25	1985	18-4138	—	—	18-3954	—	—
30	1984-86	18-4138	—	—	18-3954	—	—
C30	1991-92	18-4138	—	—	18-3954	—	—
C30	1993-97	—	18-4145	18-4146	—	—	—
40	1984-88	18-4141	—	18-4143	18-3960	—	18-3962
C40	1997-99,2001-02	—	18-4142	18-4143	18-3960	18-3961	—
P40	1998	—	—	18-4143	18-3960	18-3961	—
E48	1997	18-4097	—	18-4099	18-3969	—	—
50	1984-88	18-4141	—	18-4143	18-3960	—	18-3962
50	1996-97, 1999, 2000,2002-03	18-4141	18-4142	18-4143	18-3960	18-3961	—
C50	1998-99, 2001	—	18-4142	18-4143	18-3960	18-3961	—
P50	1996	—	18-4142	18-4143	18-3960	18-3961	—
Pro50	1987-88	18-4141	—	18-4143	18-3960	—	—
60	2001-05	18-4091	—	18-4093	18-3963	—	—
C60	1996-01	18-4091	—	18-4093	18-3963	—	—
E60 MLH,T,U,V	1995-00	—	—	—	18-3963	—	—
P60	1991-99	18-4091	—	18-4093	18-3963	—	—
70	1984-09	18-4091	—	18-4093	18-3963	—	—
C70	2000-01	18-4091	—	18-4093	18-3963	—	—
75	1994-98	18-4097	—	18-4099	18-3969	—	—
C75	1996	18-4097	—	18-4099	18-3969	—	—

APLICACIONES CONTINUAN EN LA SIGUIENTE PÁGINA



APLICACIÓN PISTON (Cont.)

HP/Modelo	Años	Estr.	PISTON		Estr.	AROS	
			.25mm	.50mm		.25mm	.50mm
C75	1998-99	18-4097	—	18-4099	18-3969	—	—
E75	1996-97	18-4097	—	18-4099	18-3969	—	—
P75	1996-99	18-4097	—	18-4099	18-3969	—	—
C80	1997	18-4097	—	18-4099	18-3969	—	—
C85	1996	18-4097	—	18-4099	18-3969	—	—
90	1994-09	18-4097	—	18-4099	18-3969	—	—
C90	1997-01	18-4097	—	18-4099	18-3969	—	—

V4 & V-6 Motores	Años	PISTON						AROS
		babor Std.	Estr. Std.	babor .25mm	Estr. .25mm	babor .50mm	Estr. .50mm	Std.
115 con/22mm pasador	V-4 1984-86	18-4128	18-4129	—	—	18-4132	18-4133	18-3934
115 con/22mm pasador	V-4 1987-92	18-4128	18-4129	—	—	18-4132	18-4133	18-3934
115 con/23mm pasador	V-4 1993-03	18-4080	18-4081	18-4082	18-4083	18-4084	18-4085	18-39320
130 con/22mm pasador	V-4 1984-92	18-4128	18-4129	—	—	18-4132	18-4133	18-3934
130 con/23mm pasador	V-4 1993-03	18-4080	18-4081	18-4082	18-4083	18-4084	18-4085	18-39320
150, 175 con/22mm pasador	V-6 1984-92	18-4128	18-4129	—	—	18-4132	18-4133	18-3934
150, 175 con /23mm pasador	V-6 1993-99	18-4080	18-4081	18-4082	18-4083	18-4084	18-4085	18-39320
200, 225 con/22mm pasador	V-6 1984-92	18-4128	18-4129	—	—	18-4132	18-4133	18-3934
200, 225 con/22mm pasador	V-6 1993-99	18-4080	18-4081	18-4082	18-4083	18-4084	18-4085	18-39320
ESPECIAL J,K,L,N,XN (6G7)	V-6 1984-86	18-4128	18-4129	—	—	18-4132	18-4133	18-3934

 <p>18-1755 BIELA Reemplaza: 650-11651-04-00 Para: 9.9, 15 (1996-97)</p>	 <p>18-1756 BIELA Reemplaza: 688-11650-03-00 Para: 55 (1991-95), 75 (1994-99), 80 (1997), 85 (1991-96), 90 (1997, 2000-01)</p>	 <p>18-1755K KIT BIELA Reemplaza: 650-11651-04-00 Para: E336 9.9 (1996-97), 15 (1996-97)</p>	 <p>18-4157 BIELA Reemplaza: 6R5-11650-10-00 Para: V6 150/175/200 (1992-03)</p>	 <p>18-1410 COJINETE Reemplaza: 93310-32337-00 Para: 115 (1993-03), 130 (1993-00, 2002-03), 150 (1992-00, 2002-03), 175 (1992-98, 2000), 200 (1992-98), 225 (1992-93, 1997)</p>
--	--	--	---	---

 <p>18-1411 COJINETE Reemplaza: 93310-620V5-00 Para: 9.9 (1996-97), 15 (1996-97)</p>	 <p>18-4077 COJINETE Reemplaza: 93310-730V8-00 Para: 45, 55, 90 HP -3 Cil.</p>	 <p>18-4078 COJINETE Reemplaza: 93310-836V2-00 Para: V4 & V6 (1990 motores)</p>	 <p>ARANDELA 18-0191 Reemplaza: 92990-06600-00</p> <p>18-0192 Reemplaza: 92990-10600-00, 929-90106-00-00, 92900-10600-00, 92901-10600-00, 92902-10600-00, 92903-10600-00, 92995-10600-00</p>	 <p>18-79974 FILTRO ACEITE Reemplaza: 6J8-13411-00 Para: 20(1996-97), 25(1988-01), 30(1987-02), 40(1989-05), 50(1989-09), 60(2001-05), 70(1989-09), C30(1995), P40(1998), P50(1991-99), P60(1991-99), PRO50(1989-90)</p>
--	--	---	---	--

 <p>18-79975 FILTRO ACEITE Reemplaza: 6E5-13411-00 Para: 115(1988-09), 130(1988-05), 150(1989-09), 175(1989-00), 200(1989-98), 225(1990-97), B115(1998-99), D150(1997-99), DX150(1999-05), L130(1989-01), L150(1988-99), L200(1988-99), LX150(1999-01), LX200(1999-01), LZ150(2000-05), LZ200(1999-12), P115(1993-96), P150(1991-99), P175(1994-99), P200(1991-99), PRO V150(1988-90), PX150(1999), S115-(1996-99), S130(1996-99), S150(1996-99), S200(1996-99)SX150(1999-04), SX200(1999-05), V150(2000-08), V175(2000), V6 Excel(1988-89), VX150(2000-04), VZ150(2000-12), VZ175(2001-12), VZ200(2001-04), Z150(2000-05), Z175(2001-05), Z200(2000-12)</p>	 <p>18-79976 FILTRO ACEITE Reemplaza: 61A-13411-00 Para: 225(1994-95), 250(1990-95), L225(1994-99), L250(1990-99), LX225(2000-03), LX250(2000-03), LZ250(2003-05), LZ300(2004-06), S225(1996-99), S250(1996-99), SX225(2000-03), SX250(2000-03), V200(1998-99), V225(1998-99), VX200(2000-05), VX225(2000-04), VX250(2002-04), VZ200(2005-09), VZ225(2003-09), VZ250(2003-09), VZ300(2004-09), Z250(2003-05), Z300(2004-06)</p>
--	---

 <p>18-79971 FILTRO ACEITE, ELECTRICO Reemplaza: 68F-13440-00 Para: LZ150(2000-05), LZ200(2000-12), LZ250(2003-05), LZ300(2004-06), VZ150(2000-12), VZ175(2001-12), VZ175(2001-12), VZ200(2001-09), VZ225(2003-09), VZ250(2003-09), VZ300(2004-09), Z150(2000-05), Z175(2001-05), Z200(2000-12), Z250(2003-05), Z300(2004-06)</p>	 <p>18-79961 FILTRO ACEITE Reemplaza: 6H1-13411-00 Para: 90(1990-01), B90(1997-99), C90(2000-01), P75(1996-99)</p>	 <p>18-7911-1 FILTRO ACEITE Reemplaza: 5GH-13440-00, 5GH-13440-10, 5GH-13440-30</p>	 <p>18-7954 FILTRO ACEITE Reemplaza: N26-13440-00-00 Para: F350</p>
---	--	--	---



18-8700
FILTRO ACEITE
 Reemplaza: 5GH-13440-20, 5JW-13400-00-00, 2MB-E3440-00-00, 1WD-E3440-00-00
 Para: F15(2006-12), F20(2006-12), F25(2009-12), F40(2008-12), F50(2005-12), F60(2005-12), F70(2010-12), T25(2009-12), T50(2005-12), T60(2005-12)



FILTRO ACEITE 4-CICLO FUERABORDA

Make-Modelo	Año	Reemplaza	Ref.
F/T9.9	1990-03	6G8-13440-00-00	18-7901
F/T50	1995-99	3FV-13440-00-00	18-7902
F15,F25	1998-99	3FV-13440-00-00	18-7902
F80/F100	1999	3FV-13440-00-00	18-7902
F40	1999-00	3FV-13440-00-00	18-7902
F200/F225	2002-06	69J-13440-00-00, -01-00, -03-00	18-7906-1
F150	2004-06	69J-13440-00-00, -01-00, -03-00	18-7906-1
F250	2005-06	69J-13440-00-00, -01-00, -03-00	18-7906-1
F350	2008-up	N26-13440-00-00	18-7954

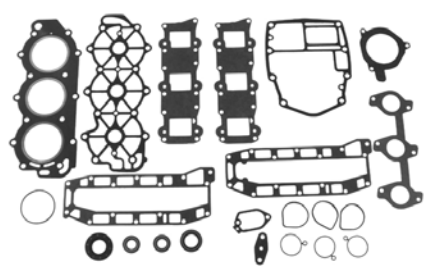

18-99061
JUEGO JUNTAS
 Reemplaza: 63D-W0001-00
 Para: 40(1995-05), 50(1995-06), C40(1997-02), C50(1998-01), P40(1998), P50(1995-96)



18-99073
JUEGO JUNTAS
 Reemplaza: 65W-W0001-20
 Para: F25(1998-00)

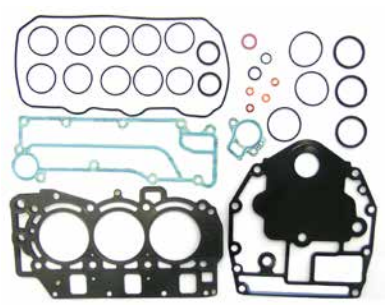

18-99092
JUEGO JUNTAS
 Reemplaza: 67C-W0001-00
 Para: F30(2001), F40(2000-01)

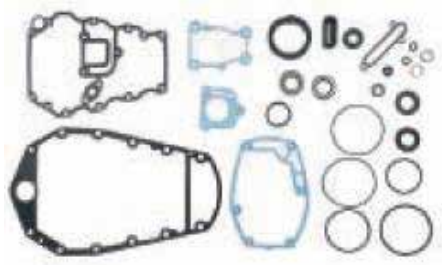

18-99093
JUEGO JUNTAS
 Reemplaza: 67C-W0001-20
 Para: F30(2001), F40(2000-01), T25(2001)

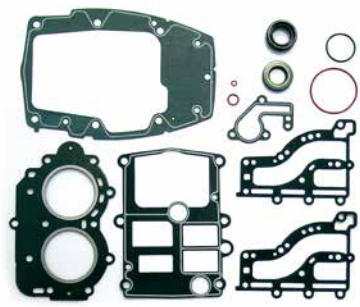

18-99097
JUEGO JUNTAS
 Reemplaza: 682-W0001-06
 Para: 9.9(1994-95), 15(1994-95)



18-99103
JUEGO JUNTAS
 Reemplaza: 68F-W0001-01
 Para: LZ150(2004-05), LZ200(2004-10), VZ150(2004-10), VZ175(2004-10), VZ200(2004), Z150(2004-05), Z175(2004-05), Z200(2004-10)



18-99104
JUEGO JUNTAS
 Reemplaza: 6A0-W0001-21
 Para: C40(1992-94)

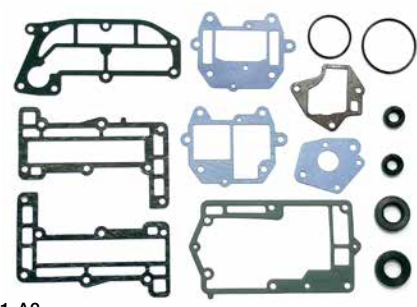

18-99117
JUEGO JUNTAS
 Reemplaza: 6G1-W0001-A2
 Para: 6(1996), 8(1996)

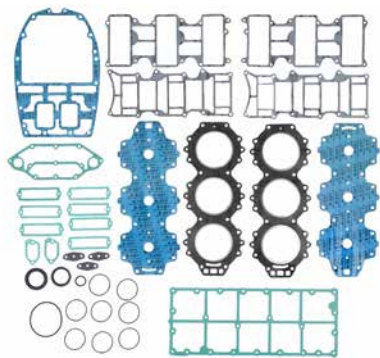

18-4400
JUEGO DE JUNTAS BLOQUE DE MOTOR
 Reemplaza: 61A-W0001-01-00, 61A-W0001-A1-00
 — CONTIENE —

Ref #	Descripción	O.E. #	Cant.
18-3891	Junta culata	61A-11181-00-A0	2
18-0829	Aro	61A-12414-A0-00, 6J8-12414-A0-00	2
18-0808	Junta válvula presión	6G5-11382-A1-00	1

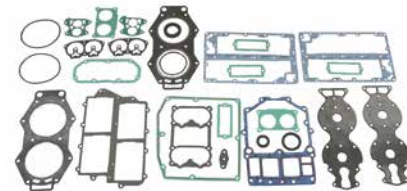

18-4403
JUEGO JUNTAS BLOQUE MOTOR
 Reemplaza: 6F3-W0001-04-00, 6F3-W0001-A4-00
 — CONTIENE —

Ref #	Descripción	O.E. #	Cant.
18-3832	Junta culata	6E5-11181-02-00	2
18-0844	Junta tapa termostato	688-12414-A1-00	2
18-2079	Retén aceite	93101-22M15-00	1
18-2085	Retén aceite	93102-35M13-00	1
18-7442	Aro	93210-74M35-00	1
18-7444	Aro	93211-04384-00	2
18-0782	Junta tapa	6E5-11381-A1-00	1
18-0799	Junta tapa escape	6E5-41112-A1-00	2
18-0823	Junta colector escape	6E5-13645-A1-00	1
18-0785	Junta montaje carburador	6E5-14198-A1-00	2
18-0813	Junta base	6G5-45113-A0-00	1
18-2592	Junta flotador	6E5-14384-03-00	2
18-0781	Junta tapa agua	6E5-11193-A0-00	2

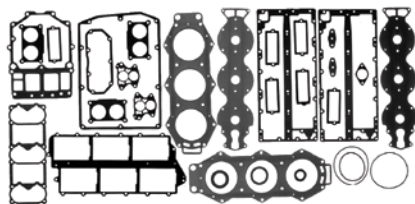

18-4404
JUEGO JUNTAS BLOQUE MOTOR
 Reemplaza: 6G5-W0001-03-00, 6G5-W0001-A3-00
 — CONTIENE —

Ref #	Descripción	O.E. #	Cant.
18-3894	Junta culata	6G5-11181-A0-00	2
18-0844	Junta tapa termostato	688-12414-A1-00	2
18-2079	Retén aceite	93101-22M15-00	1
18-2085	Retén aceite	93102-35M13-00	1
18-7442	Aro	93210-74M35-00	1
18-7444	Aro	93211-04384-00	2
18-0785	Junta montaje carburador	6E5-14198-A1-00	3
18-0808	Junta válvula presión	6G5-11382-A1-00	1
18-0813	Junta base	6G5-45113-A0-00	1
18-0782	Junta tapa	6E5-11381-A1-00	1
18-0809	Junta bloque	6G5-13645-A1-00	1
18-0812	Junta tapa escape	6G5-41112-A1-00	2
18-0779	Junta tapa agua	6G5-11193-A0-00	2

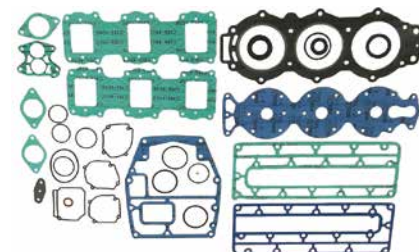

18-4405
JUEGO DE JUNTAS BLOQUE MOTOR
 Reemplaza: 6H1-W0001-00-00, 6H1-W0001-01-00, 6H1-W0001-A0-00
 — CONTIENE —

Ref #	Descripción	O.E. #	Cant.
18-3805	Junta culata	688-11181-02-00	1
18-0840-1	Aro	676-14984-00-00	3
18-0844	Junta tapa termostato	688-12414-A1-00	1
18-0847	Junta tapa escape	688-41112-A0-00	1
18-0826	Junta tornillo drenaje	90430-14115-00	1
18-7436	Aro	93210-46044-00	3
18-0767	Junta Tapa Agua	688-11193-01-00	1

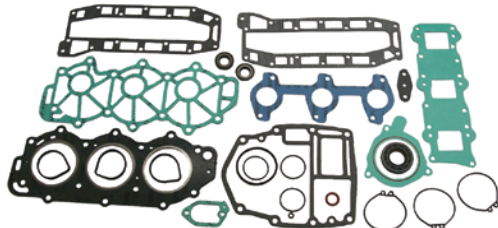

18-4407
JUEGO JUNTAS BLOQUE MOTOR
 Reemplaza: 6H4-W0001-01-00, 6H4-W0001-A1-00
 — CONTIENE —

Ref #	Descripción	O.E. #	Cant.
18-3830	Junta culata	6H4-11181-00-00	1
18-0826	Junta tornillo drenaje	90430-14115-00	1
18-0815	Junta tapa agua	6H4-11193-A1-00	1
18-0798	Junta tapa escape	6H4-41114-A0-00	1
18-0829	Junta tapa	61A-12414-A0-00, 6J8-12414-A0-00	1

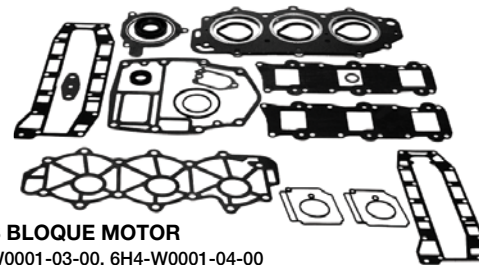

18-4409
JUEGO JUNTAS BLOQUE MOTOR
 Reemplaza: 6H4-W0001-03-00, 6H4-W0001-04-00
 — CONTIENE —

Ref #	Descripción	O.E.#	Cant.
18-3830	Junta culata	6H4-11181-00-00	1
18-0826	Junta tornillo drenaje	90430-14115-00	1
18-7432	Aro	93210-32768-00	1
18-0815	Junta tapa agua	6H4-11193-A1-00	1
18-0798	Junta tapa escape	6H4-41114-A0-00	1
18-0829	Junta tapa	61A-12414-A0-00, 6J8-12414-A0-00	1

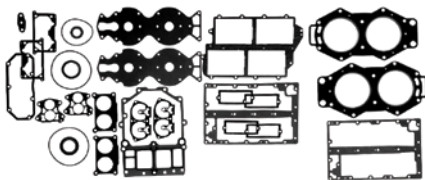

18-4411
JUEGO JUNTAS BLOQUE MOTOR
 Reemplaza: 6N6-W0001-03-00, 6N6-W0001-A3-00
 — CONTIENE —

Ref #	Descripción	O.E. #	Cant.
18-3832	Junta culata	6E5-11181-02-00	2
18-0844	Junta tapa termostato	688-12414-A1-00	2
18-2079	Retén aceite	93101-22M18-00	1
18-2085	Retén aceite	93102-35M13-00	1
18-7442	Aro	93210-74M35-00	1
18-7444	Aro	93211-04384-00	2
18-0782	Junta tapa	6E5-11381-A1-00	1
18-0799	Junta tapa escape	6E5-41112-A1-00	2
18-0823	Junta colector escape	6E5-13645-A1-00	1
18-0785	Junta montaje carburador	6E5-14198-A1-00	2
18-0813	Junta base	6G5-45113-A0-00	1
18-2592	Junta flotador	6E5-14384-03-00	2
18-0781	Junta tapa agua	6E5-11193-A0-00	2



18-4412
JUEGO JUNTAS BLOQUE MOTOR
 Reemplaza: 6R3-W0001-03-00, 6R3-W0001-A3-00
 — CONTIENE —

Ref #	Descripción	O.E. #	Cant.
18-3894	Junta culata	6G5-11181-A0-00	2
18-0844	Junta tapa termostato	688-12414-A1-00	2
18-2079	Retén aceite	93101-22M18-00	1
18-2085	Retén aceite	93102-35M13-00	1
18-7442	Aro	93210-74M35-00	1
18-7444	Aro	93211-04384-00	2
18-0782	Junta tapa	6E5-11381-A1-00	1
18-0809	Junta bloque	6G5-13645-A1-00	1
18-0812	Junta tapa escape	6G5-41112-A1-00	2
18-0779	Junta tapa agua	6G5-11193-A0-00	2
18-0785	Junta montaje carburador	6E5-14198-A1-00	3
18-0808	Junta válvula presión	6G5-11382-A1-00	1
18-0816	Junta base	6G5-45113-A0-00	1

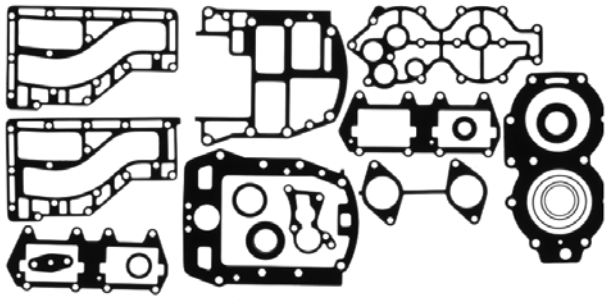

18-4413
JUEGO JUNTAS BLOQUE MOTOR
 Reemplaza: 6R6-W0001-01-00

— CONTIENE —

Ref #	Descripción	O.E. #	Cant.
18-3892	Junta culata	676-11181-00-A0	1
18-7126	Aro	—	1

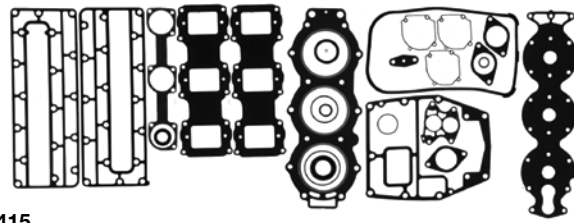

18-4415
JUEGO JUNTAS BLOQUE MOTOR
 Reemplaza: 688-W0001-00-00, 688-W0001-A0-00

— CONTIENE —

18-0840	Retén cazoleta comb	676-14984-00-00	3
18-3805	Junta culata	688-11181-02-00	1
18-0844	Junta tapa termostato	688-12414-A1-00	1
18-0846	Junta montaje carburador	688-14198-A1-00	3
18-0847	Junta tapa escape	688-41112-A0-00	2
18-0826	Junta tornillo drenaje	90430-14115-00-00	1
18-0767	Junta	688-11193-01-00	1
18-0845	Junta platina colector admisión	688-13621-A1-00	2
18-7441	Aro	93210-62269-00	1

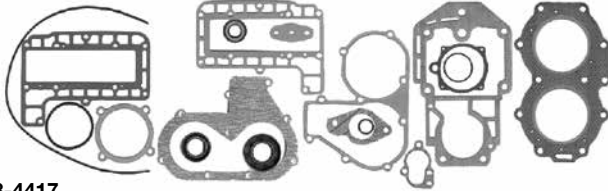

18-4417
JUEGO JUNTAS BLOQUE MOTOR
 Reemplaza: 695-W0001-01-00, 695-W0001-02-00, 695-W0001-A2-00

— CONTIENE —

Ref #	Descripción	O.E. #	Cant.
18-0231	Junta	648-13621-A1-00	1
18-0771	Junta colector admisión	648-13645-A0-00	1
18-0775	Junta montaje carburador	648-14198-A0-00	1
NSS	Junta	648-14384-01-00	1
18-0232	Junta tapa	655-12414-A1-00	1
18-0250	Junta tapa escape	664-41114-A0-00	2
18-2078	Retén aceite	93101-16M36-00	1
18-0570	Retén aceite	93102-23096-00	1
18-3849	Junta culata	695-11181-A0-00	1
18-0739	Junta superior	689-45113-A1-00	1

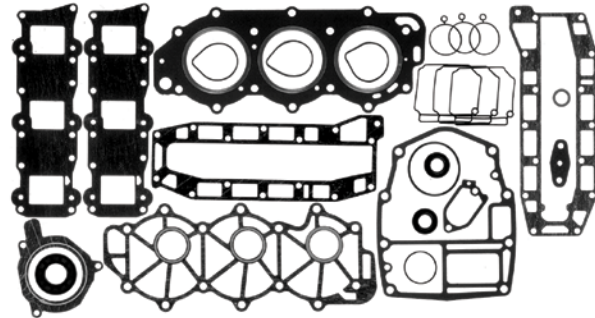

18-4419
JUEGO JUNTAS BLOQUE MOTOR
 Reemplaza: 6H4-W0001-02-00, 6H4-W0001-A2-00

— CONTIENE —

Ref #	Descripción	O.E. #	Cant.
18-3830	Junta culata	6H4-11181-00-00	1
18-0826	Junta tornillo drenaje	90430-14115-00-00	1

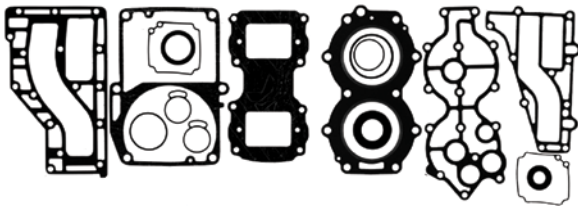

18-4422
JUEGO JUNTAS BLOQUE MOTOR
 Reemplaza: 6L2-W0001-01-00, 6L2-W0001-02-00, 6L2-W0001-A2-00

— CONTIENE —

Ref #	Descripción	O.E. #	Cant.
18-3847	Junta culata	6L2-11181-A1-00	1
18-0765	Junta	6L2-14384-00-00	1
18-0743	Junta tapa escape	6L2-41112-A1-00	1
18-0744	Junta tapa escape	6L2-41114-A1-00	1
18-0748	Junta tapa superior	6L2-45113-A1-00	1

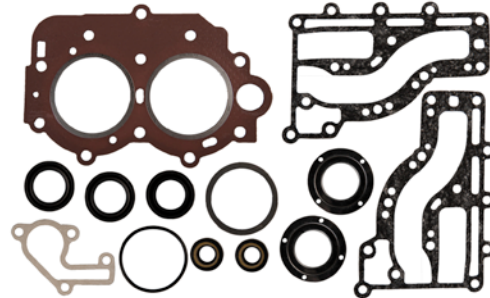



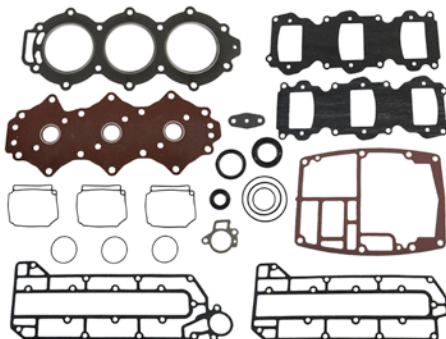



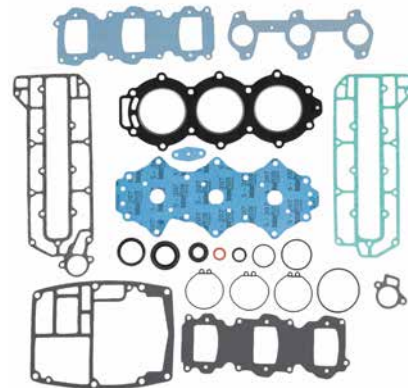



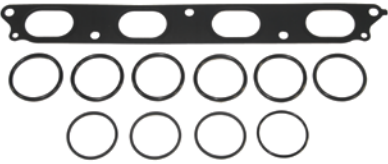

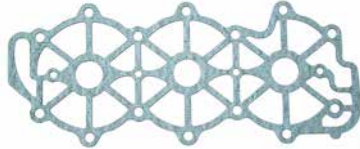

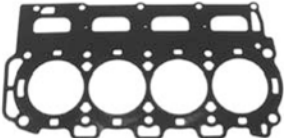



18-99175
JUEGO JUNTAS BLOQUE MOTOR
 Reemplaza: 63V-W0001-00, 63V-W0001-01
 Para: 9.9(1996-00), 15(1996-00)



18-99176
JUEGO JUNTAS BLOQUE MOTOR
 Reemplaza: 6H3-W0001-02
 Para: 60(2001-05), 70(1994-09), C70(2000-01), P60(1994-99)



18-4427
JUEGO JUNTAS BLOQUE MOTOR
 Reemplaza: 6H3-W0001-A0-00

 <p>18-0663 KIT DE JUNTAS Para: Yamaha F75 (2003-04), F80 (1999-03), F90 (2003-04), F100 (1999-02)</p>	 <p>18-99048 JUNTA CULATA Reemplaza: 60V-11181-00 Para: LZ250(2003-05), VZ200(2005-09), VZ225(2003-09), VZ250(2003-09), Z250(2003-05)</p>	 <p>18-99059 JUNTA CULATA Reemplaza: 63D-11193-A0 Para: 40(1995-05), 50(1995-09), C40(1997-03), C50(1998-01), P40(1998), P50(1995-96)</p>	
 <p>18-99060 JUNTA CULATA Reemplaza: 63D-11181-A1 Para: 40(1997-05), 50(1997-08), C40(1997-03), C50(1998-01), P40(1998)</p>	 <p>18-99062 JUNTA CULATA Reemplaza: 68F-11181-00 Para: LZ150(2000-05), LZ200(2000-10), VZ150(2000-10), VZ175(2001-10), VZ200(2001-04), Z150(2000-05), Z175(2001-05), Z200(2000-10)</p>	 <p>18-99094 JUNTA CULATA Reemplaza: 67F-11181-02 Para: F75(2004-05), F90(2004-05), F115(2004-05), LF115(2004-05)</p>	 <p>18-3804 JUNTA CULATA Reemplaza: 689-11181-02-00, 689-W0001-A1-00</p>
 <p>18-3805 JUNTA CULATA Reemplaza: 688-11181-02-00, 688-11181-A1-00</p>	 <p>18-3827 JUNTA CULATA Reemplaza: 6G8-11181-00-00, 6G8-11181-A1-00</p>	 <p>18-3828 JUNTA CULATA Reemplaza: 6E7-11181-00-00, 6E7-11181-A1-00</p>	 <p>18-3829 JUNTA CULATA Reemplaza: 6J8-11181-00-00, 6J8-11181-A1-001</p>
 <p>18-3830 JUNTA CULATA Reemplaza: 6H4-11181-00-00, 6H4-11181-A1-00</p>	 <p>18-3831 JUNTA CULATA Reemplaza: 6H3-11181-01-00, 6H3-11181-A1-00</p>	 <p>18-3832 JUNTA CULATA Reemplaza: 6E5-11181-02-00, 6E5-11181-A1-00</p>	
 <p>18-3847 JUNTA CULATA Reemplaza: 6L2-11181-A1-00, 6L2-11181-A2-00</p>	 <p>18-3848 JUNTA CULATA Reemplaza: 697-11181-A0-00, 697-11181-A1-00</p>	 <p>18-3849 JUNTA CULATA Reemplaza: 695-11181-A0-00, 695-11181-A1-00</p>	
 <p>18-3891 JUNTA CULATA Reemplaza: 61A-11181-A0-00, 61A-11181-A1-00</p>	 <p>18-3892 JUNTA CULATA Reemplaza: 676-11181-A0-00, 676-11181-A1-00</p>	 <p>18-3894 JUNTA CULATA Reemplaza: 6G5-11181-00-00, 6G5-11181-A0-00</p>	

JUEGO JUNTAS BLOQUE MOTOR \ APLICACIÓN JUNTA CULATA

HP	Año	Juego juntas bloque motor	Junta Culata	HP	Año	Juego juntas bloque motor	Junta Culata
6	1988-96	18-99117		F80	1999-01		18-99094
8	1984-96	18-99117		F80	2002-03		18-99094
9.9	1984-87		18-3828	C85	1991	18-4415	18-3805
9.9	1988-91		18-3828	C85	1992-93		18-3805
9.9	1992-93		18-3828	C85	1994-96		18-3805
9.9	1994-95		18-3828	CV85	1989-90	18-4415	18-3805
9.9	1996	18-99175		90	1984-93	18-4405	18-3805
9.9	1997-00	18-99175	18-99140	90	1994-09		18-3805
9.9	2001-08		18-99140	B90	1997-99		18-3805
F9.9	1986-89		18-3827	C90	1997-01		18-3805
F9.9	1990-05		18-3827	F90	2003-04		18-99094
FT9.9	1985-87		18-3827	F90	2005-11		18-99094
FT9.9	1988-89		18-3827	F100	1999-01		18-99094
FT9.9	1990		18-3827	F100	2002-03		18-99094
T9.9	1991-05		18-3827	115	1984		18-3832
15	1984-87		18-3828	115	1985		18-3832
15	1988-91		18-3828	115	1986	1	18-3832
15	1992-93		18-3828	115	1986-89	2	18-3832
15	1994-95	18-99097		115	1990-99	18-4411	18-3832
15	1996	18-99175		115	2000-01		18-3832
15	1997-00	18-99175	18-99140	115	2002-09		18-3832
15	2001-08		18-99140	B115	1998-99		18-3832
20	1996-97		18-3847	C115	1991-95	18-4403	18-3832
25 (2 cil)	1984-87		18-3804	C115	1996-99		18-3832
25 (2 cil)	1988-93	18-4422	18-3847	C115	2000		18-3832
25 (2 cil)	1994-09		18-3847	F115	2000-01		18-99094
25 (3 cil)	1997-02		18-3829	F115	2002-05		18-99094
C25	1991-93	18-4417	18-3849	F115	2006-11		18-99094
C25	1994-97		18-3849	LF115	2000-01		18-99094
CV25	1990	18-4417	18-3849	LF115	2002-05		18-99094
F25	1998-01	18-99073		LF115	2006-11		18-99094
30	1984-86		18-3804	P115	1993-96	18-4411	18-3832
30	1987-94		18-3829	S115	1996-99	18-4411	18-3832
30	1993-02		18-3829	130	1988-99	18-4403	18-3832
C30	1991-92		18-3804	130	2000-01		18-3832
C30	1995-97		18-3829	130	2002-04		18-3832
CV30	1989-90		18-3804	L130	1989	18-4403	18-3832
F30	2000	18-99093		L130	1990-99	18-4411	18-3832
F30	2001-05	18-99092		L130	2000-01		18-3832
40	1984-88	18-4407	18-3830	S130	1996-99	18-4411	18-3832
40	1989-91	18-4419	18-3830	150	1984-89	18-4404	18-3894
40	1992-94	18-4409	18-3830	150	1990-95	18-4412	18-3894
40	1995-05	18-99061	18-99060	150	1996-03		18-3894
C40 2 Cil	1991		18-3892	150	2004-09		18-3894
C40 2 Cil	1992-93	18-4413	18-3892	C150	1996-99	18-4404	18-3894
C40 2 Cil	1994-97	18-4414	18-3892	D150	1997-99		18-3894
C40 3 Cil	1998-03	18-99061	18-99060	DX150	1999-03		18-3894
CV40	1990		18-3892	DX150	2004-05		18-3894
F40	2000-08	18-99092		L150	1986-89	18-4404	18-3894
P40	1998	18-99061	18-99060	L150	1990-95	18-4412	18-3894
50	1984-88	18-4407	18-3830	L150	1996-99		18-3894
50	1989-91	18-4419	18-3830	LX150	1999-01		18-3894
50	1992-94	18-4419	18-3830	LZ150	2000-03		18-99062
50	1995-09	18-99061	18-99060	LZ150	2004-05	18-99103	18-99062
C50	1998-01	18-99061	18-99060	Z150	2000-03		18-99062
PRO 50	1987-88	18-4407	18-3830	Z150	2004-05	18-99103	18-99062
PRO 50	1989-90	18-4419	18-3830	P150	1991-93	18-4412	18-3894
P50	1991	18-4419	18-3830	P150	1994-95		18-3894
P50	1992-94	18-4409	18-3830	P150	1996-99		18-3894
P50	1995-96	18-99061	18-99060	PX150	1999		18-3894
C55	1991		18-3848	PRO V150	1987-89	18-4404	18-3894
C55	1992-93		18-3848	PRO V150	1990	18-4412	18-3894
C55	1994-95		18-3848	S150	1996-99		18-3894
CV55	1989-90		18-3848	SX150	1999-03		18-3894
60	2001-05	18-99176	18-3831	SX150	2004		18-3894
C60	1996-01		18-3831	V150	2000-03		18-3894
E60	1995-00		18-3831	V150	2004-08		18-3894
P60	1991	18-4427	18-3831	VX150	2000-03		18-3894
P60	1992-93		18-3831	VX150	2004		18-3894
P60	1994-99	18-99176	18-3831	VZ150	2000-03		18-99062
70	1984-91	18-4427	18-3831	VZ150	2004-11	18-99103	18-99062
70	1992-93		18-3831	175	1984-89	18-4404	18-3894
70	1994-09	18-99176	18-3831	175	1990-95	18-4412	18-3894
C70	2000-01	18-99176	18-3831	175	2000		18-3894
C75	1994-96		18-3805	P175	1996-99		18-3894
C75	1998-99		18-3805	S175	1996-99		18-3894
E75	1995-00		18-3805	V175	2000		18-3894
F75	2003-04		18-99094	VZ175	2001-02		18-99062
F75	2005, 2007-11		18-99094	VZ175	2003-11	18-99103	18-99062
F75	2006		18-99094	Z175	2001-03		18-99062
P75	1996-99		18-3805	Z175	2004-05	18-99103	18-99062
C80	1997		18-3805	200	1984-89	18-4404	18-3894

① LJ:-357803/XJ:-700843

③ 2.6 litros

② LJ: 357804/XJ: 700844

④ 3.1 litros















HP	Año	Juego de juntas bloque motor	Junta Culata	HP	Año	Juego de juntas bloque motor	Junta Culata
200	1990-95	18-4412	18-3894	L225 ④	1994-96	18-4400	18-3891
200	1996-98		18-3894	L225	1997-99		18-3891
L200	1986-89	18-4404	18-3894	S225	1996	18-4400	18-3891
L200	1990-95	18-4412	18-3894	S225	1997-99		18-3891
L200	1996-99		18-3894	LX225	2000-03		18-3891
LX200	1999-01		18-3894	SX225	2000-03		18-3891
LZ200	2000-03		18-99062	V225	1998-99		18-3891
LZ200	2004-11	18-99103	18-99062	VX225	2000-04		18-3891
P200	1991-95		18-3894	VZ225	2003-04		18-99048
P200	1996-99		18-3894	VZ225	2005-09		18-99048
S200	1996-99		18-3894	250	1990-95	18-4400	18-3891
SX200	1999-03		18-3894	L250	1990-96	18-4400	18-3891
SX200	2004-05		18-3894	L250	1997-99		18-3891
V200	1998-99		18-3891	LX250	2000-03		18-3891
VX200	2000-05		18-3891	LZ250	2003-04		18-99048
VZ200	2000-03		18-99062	LZ250	2005		18-99048
VZ200	2004-09	18-99103	18-99062	S250	1996	18-4400	18-3891
Z200	2000-03		18-99062	S250	1997-99		18-3891
Z200	2004-11	18-99103	18-99062	SX250	2000-03		18-3891
V6 Special	1984-86	18-4404	18-3894	VZ250	2003-04		18-99048
V6 Excel	1987-89		18-3894	VZ250	2005-09		18-99048
225 ③	1990-95		18-3894	Z250	2003-04		18-99048
225	1996-97		18-3894	Z250	2005		18-99048
225 ④	1994-95	18-4400	18-3891				

① LJ:-357803/XJ:-700843

② LJ: 357804/XJ: 700844

③ 2.6 litros

④ 3.1 litros

 <p>18-0406 JUNTA BOMBA DE AGUA Reemplaza: 60X-43315-A0-00 Para: VZ200 (3.3L) 2005-10, VZ225 (3.3L) 2003-10, VZ250 (3.3L) 2003-10, VZ300 (3.3L) 2005-10</p>	 <p>18-0605 RETÉN COLECTOR ESCAPE Reemplaza: 67F-41138-00-00 Para: F75 2003-Actual: F80 1999-2003; F90 2003-Actual: F100 1999-2003; F115 2000-Actual.</p>	 <p>18-0617 RETÉN ESCAPE Reemplaza: 67F-45127-00-00 Para: F75 2003-Actual: F80 1999-2003; F90 2003-Actual: F100 1999-2003; F115 2000-Actual.</p>	 <p>18-0618 JUNTA DE COLECTOR ESCAPE Reemplaza: 68V-45123-00-00</p>
 <p>18-0619 RETÉN TUBO ESCAPE Reemplaza: 69J-41138-00-00</p>	 <p>18-0656 RETÉN TUBO ESCAPE Reemplaza: 69J-45123-00-00</p>	 <p>18-0755 JUNTA VACIADO DE CÁRTER Reemplaza: 90430-14M09-00, 90430-14228-00, 90430-14228-00 Para: 4-tiempos 9.9hp.- 300hp. / 1999 - Actual</p>	 <p>18-0849 JUNTA MONTAJE BOMBA COMBUSTIBLE Reemplaza: 650-24431-A0-00</p>
 <p>18-0856 JUNTA Reemplaza: 64D-14384-01-00</p>	 <p>18-99000 JUNTA COLECTOR ESCAPE Reemplaza: 61A-41134-A0 Para: 225(1994-95), 250(1992-95), L225 (1994-99), L250(1992-99), LX225(2000-03), LX250(2000-03), LZ250(2003-05), LZ300 (2004-05), S225(1996-99), S250(1996-99), SX225(2000-03), SX250(2000-03), V200(1998-99), V225(1998-99), VX200(2000-05), VX250 (2000-04), VZ200(2005), VZ225(2003-05), VZ250(2003-05), VZ300(2004-05), Z250(2003-05), Z300(2004-05)</p>	 <p>18-99001 JUNTA DE CARTER SUPERIOR Reemplaza: 61A-45114-A0 Para: 225(1994-95), 250(1992-95), L225 (1994-99), L250(1992-99), LX225(2000-03), LX250(2000-03), S225(1996-99), S250 (1996-99), SX225(2000-03), SX250 (2000-03), V200(1998-99), V225(1998-99), VX200(2000-05), VX225(2000-04), VX250(2002-04)</p>	 <p>18-99002 JUNTA COLECTOR ESCAPE Reemplaza: 62Y-41133-00 Para: F25(1998-00), F40(1999), F50(1995-00), T50(1996-00)</p>
 <p>18-99003 JUNTA ESCAPE Reemplaza: 62Y-41134-01 Para: F30(2002-05), F40(2002-08), F50(2002-04), F60(2002-04), T25(2002-05), T50(2002-04)</p>	 <p>18-99004 JUNTA CÁRTER SUPERIOR Reemplaza: 63D-45114-A0 Para: 40(1995-05), 50(1995-09), C40(1997-03), C50(1998-01), P40(1998), P50(1995-96)</p>	 <p>18-99005 JUNTA SILENCIADOR Reemplaza: 63D-45123-00 Para: 40(1995-05), 50(1995-09), C40(1997-03), C50(1998-01), P40(1998), P50(1995-96)</p>	 <p>18-99006 JUNTA COLECTOR ESCAPE Reemplaza: 63V-41133-A1 Para: 9.9(1997-09), 15(1997-09)</p>



18-99008
JUNTA COLECTOR
ESCAPE
 Reemplaza: 64J-41133-10
 Para: F40(2008-10), F60(2002-04), T25(2009-10), T60(2003-04)



18-99009
JUNTA SILENCIADOR
 Reemplaza: 663-45123-00
 Para: (1985-94), (1984-94), C55(1991-95), CV55(1989-90), E48(1995-00), F40(1999), F50(1995-04), P50(1991-94), PR50(1989), PRO 50(1987-90), T50(1996-04)

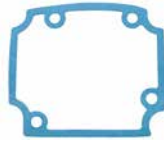

18-99010
JUNTA COLECTOR
ESCAPE
 Reemplaza: 664-41134-A0
 Para: C25(1992-97), C30(1992-97)



18-99012
JUNTA COLECTOR
ESCAPE
 Reemplaza: 66M-41133-00
 Para: F15(1998-04)

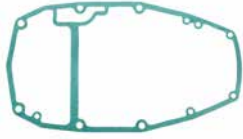

18-99013
JUNTA
CÁRTER SUPERIOR
 Reemplaza: 66M-45113-00
 Para: F9.9 (2005-06), F15(1998-05), T9.9(2005-06)



18-99014
JUNTA COLECTOR
ESCAPE
 Reemplaza: 676-41133-A0
 Para: C40(1992-97)

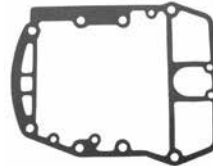

18-99015
JUNTA
CÁRTER SUPERIOR
 Reemplaza: 676-45114-A0
 Para: C40(1991-97), CV40(1990)



18-99016
JUNTA COLECTOR
ESCAPE
 Reemplaza: 67C-41133-00
 Para: F25(2001-05, 2009-10), F30(2001-05), F40(2000-08), F50(2001-04), T25(2005-06)



18-99017
JUNTA SILENCIADOR
 Reemplaza: 67C-45123-00
 Para: F30(2001-05), F40(2000-10), F60(2002-04), T25(2001-06, 2009-10), T60(2003-04)



18-99018
JUNTA COLECTOR
ESCAPE
 Reemplaza: 67F-41133-A1
 Para: F75(2003-10), F90(2004-10), F115(2004-10), LF115(2004-10)



18-99019
JUNTA COLECTOR
ESCAPE
 Reemplaza: 67F-41134-A0
 Para: F75(2003-10), F80(1999-03), F90(2003-10), F100(1999-03), F115(2000-10), LF115(2000-10)



18-99020
JUNTA SILENCIADOR
 Reemplaza: 67F-45123-00
 Para: F75(2003-10), F80(1999-03), F90(2003-10), F100(1999-03)



18-99021
JUNTA
COLECTOR ESCAPE
 Reemplaza: 682-41133-A0
 Para: 9.9(1992-95), 15(1992-95)



18-99022
JUNTA
CÁRTER SUPERIOR
 Reemplaza: 682-45113-A1
 Para: 9.9(1984-95), 15(1984-95)



18-99023
JUNTA COLECTOR
ESCAPE
 Reemplaza: 688-41133-00
 Para: 90(1984-09), B90(1997-99), C75(1994-96, 98-99), C80(1997), C85(1991-96), C90(1997-01), CV85(1989-90), E75(1995-00), P75(1996-99)

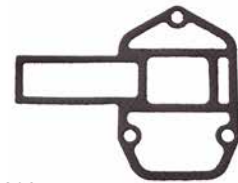

18-99024
JUNTA COLECTOR
ESCAPE
 Reemplaza: 688-41134-A0
 Para: 90(1984-09), B90(1997-99), C75(1994-99), C80(1997), C85(1991-96), C90(1997-01), CV85(1989-90), E75(1995-00), P75(1996-99)

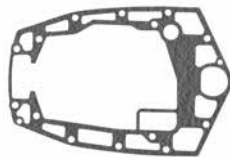

18-99025
JUNTA CÁRTER
SUPERIOR
 Reemplaza: 688-45114-A1
 Para: 90(1984-09), B90(1997-99), C75(1994-99), C80(1997), C85(1991-96), C90(1997-01), CV85(1989-90), E75(1995-00), P75(1996-99)





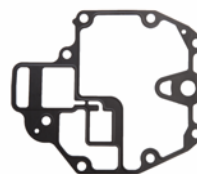



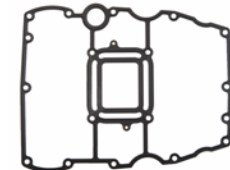





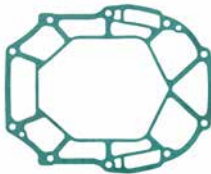

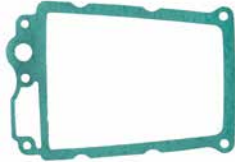

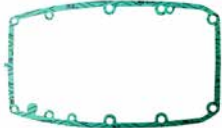
18-99026
JUNTA SILENCIADOR
 Reemplaza: 688-45123-00
 Para: 90(1984-09), B90(1997-99), C75(1994-99), C80(1997), C85(1991-96), C90(1997-01), CV85(1989-90), E75(1995-00), P75(1996-99)



18-99027
JUNTA CÁRTER
 Reemplaza: 68T-13475-00
 Para: F6(2001-08), F8(2001-10), F9.9(2007, 2010), T8(2001-10), T9.9(2007-10)

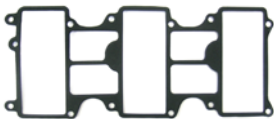
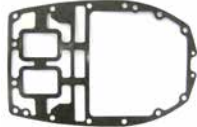
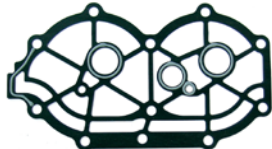

18-99028
JUNTA CÁRTER
 Reemplaza: 68V-15312-00
 Para: F75(2003-10), F90(2004-10), F115(2004-10), LF115(2004-10)

 <p>18-99030 JUNTA CÁRTER SUPERIOR Reemplaza: 697-45114-A0 Para: E48(1995-00), C55(1992-95)</p>	 <p>18-99032 JUNTA COLECTOR ESCAPE Reemplaza: 69J-41134-A0 Para: F200(2002-05), F225(2002-05), LF200(2002-05), LF225(2002-05)</p>	 <p>18-99033 JUNTA COLECTOR ESCAPE Reemplaza: 69J-41135-A0 Para: F200(2002-10), F225(2002-10), F250(2005-10), LF200(2002-10), LF225(2002-10), LF250(2005-10)</p>	 <p>18-99034 JUNTA COLECTOR ESCAPE Reemplaza: 69J-41136-A0 Para: F200(2002-05), F225(2002-05), F250(2005), LF200(2002-05), LF225(2002-05), LF250(2005)</p>	
 <p>18-99037 JUNTA COLECTOR ESCAPE Reemplaza: 6E5-41134-A0 Para: 115(1992-09), 130(1992-04), B115(1998-99), C115(1992-00), L130(1994-01), P115(1993-96), S115(1996-99), S130(1996-99)</p>	 <p>18-99038 JUNTA COLECTOR ESCAPE Reemplaza: 6E5-41135-A0 Para: 115(1992-09), 130(1992-04), 150(1992-09), 175(1992-95), 2000, 200(1992-98), 225(1992-97), B115(1998-99), C115(1992-00), C150(1996-99), D150(1997-99), DX150(1999-05), L150(1992-01), L200(1992-99), LX150(1999-01), LX200(1999-01), LZ150(2000-05), LZ200(2000-10), P115(1993-96), P150(1992-99), P175(1994-99), P200(1992-99), PX150(1999), S115(1996-99), S130(1996-99), S150(1996-99), S175(1996-99), S200(1996-99), SX150(1999-04), SX200(1999-05), V150(2000-08), V175(2000), VX150(2000-04), VZ150(2000-10), VZ175(2001-10), VZ200(2001-04), Z150(2000-05), Z175(2001-05), Z200(2000-10)</p>	 <p>18-99039 JUNTA COLECTOR ESCAPE Reemplaza: 6G5-41134-A1 Para: 115(2003-04), 130(2003-04), 150(2003-09), DX150(2003-05), LZ150(2003-05), LZ200(2003-10), SX150(2003-04), SX200(2003-05), V150(2003-08), VX150(2003-04), VZ150(2003-10), VZ175(2003-10), VZ200(2003-04), Z150(2003-05), Z175(2003-05), Z200(2003-10)</p>	 <p>18-99040 JUNTA CÁRTER SUPERIOR Reemplaza: 6G5-45114-A1 Para: 115(2003-09), 130(2003-04), 150(2003-09), DX150(2003-05), LZ150(2003-05), LZ200(2003-10), SX150(2003-04), SX200(2003-05), V150(2003-08), VX150(2003-04), VZ150(2003-10), VZ175(2003-10), VZ200(2003-04), Z150(2003-05), Z175(2003-05), Z200(2003-10)</p>	
 <p>18-99045 JUNTA CÁRTER SUPERIOR Reemplaza: 6G8-45113-A1 Para: F9.9(1997-05), T9.9(1995-05)</p>	 <p>18-99046 JUNTA CÁRTER SUPERIOR Reemplaza: 6H3-45114-A1 Para: 60(2002-05), 70(1984-069), C60(1996-01), C70(2001-02), E60(1995-00), P60(1991-99)</p>	 <p>18-99047 JUNTA SILENCIADOR Reemplaza: 6H3-45123-00 Para: 60(2001-05), 70(1984-09), C60(1996-01), C70(2000-01), E60(1995-00), P60(1991-99)</p>	 <p>18-99049 JUNTA Reemplaza: 60V-13621-A0 Para: LZ250(2003-05), LZ300(2004-06), VZ200(2005-09), VZ225(2003-09), VZ250(2003-09), VZ300(2004-09), Z250(2003-05), Z300(2004-06)</p>	 <p>18-99050 JUNTA DE ADMISIÓN Reemplaza: 60V-13645-00 Para: LZ250(2003-05), LZ300(2004-06), VZ200(2005-09), VZ225(2003-09), VZ300(2004-09), Z250(2003-05), Z300(2004-06)</p>
 <p>18-99051 JUNTA TAPA VÁLVULA Reemplaza: 61A-11193-A1 Para: L225(1996-99), L250(1996-99), LX225(2000-03), LX250(2000-03), S225(1996-99), S250(1996-99), SX225(2000-03), SX250(2000-03), V200(1998-99), V225(1998-99), VX200(2000-05), VX225(2000-04), VX250(2002-04)</p>	 <p>18-99052 JUNTA TAPA Reemplaza: 61A-11381-A0 Para: 225(1994-95), 250(1992-95), L225(1994-99), L250(1992-99), LX225(2000-03), LX250(2000-03), S225(1996-99), S250(1996-99), SX225(2000-03), SX250(2000-03), V200(1998-99), V225(1998-99), VX200(2000-05), VX225(2000-04), VX250(2002-04)</p>	 <p>18-99053 JUNTA DE ADMISIÓN Reemplaza: 61A-13621-A0 Para: 225(1994-95), 250(1992-95), DX150(1999-05), L225(1994-99), L250(1992-99), LX150(1999-01), LX200(1999-01), LX225(2000-03), LX250(2000-03), LZ150(2000-05), LZ200(2000-10), PX150(1999), S225(1996-99), S250(1996-99), SX150(1999-04), SX200(1999-05), SX225(2000-03), SX250(2000-03), V200(1998-99), V225(1998-99), VX150(2000-04), VX200(2000-05), VX225(2000-04), VX250(2002-04), VZ150(2000-10), VZ175(2001-10), VZ200(2001-04), Z150(2000-05), Z175(2001-05), Z200(2000-10)</p>	 <p>18-99054 JUNTA DE ADMISIÓN Reemplaza: 61A-13645-00 Para: 225(1994-95), 250(1990-95), L225(1994-96), L250(1990-96), S225(1996), S250(1996)</p>	
 <p>18-99055 JUNTA COLECTOR Reemplaza: 61A-13646-00 Para: 225(1994-95), 250(1990-95), L225(1994-96), L250(1990-96), S225(1996), S250(1996)</p>	 <p>18-99056 JUNTA BASE Reemplaza: 61A-45113-A0 Para: 225(1994-95), 250(1990-95), L225(1994-99), L250(1990-99), LX225(2000-03), LX250(2000-03), S225(1996-99), S250(1996-99), SX225(2000-03), SX250(2000-03), V200(1998-99), V225(1998-99), VX200(2000-05), VX225(2000-04), VX250(2002-04)</p>	 <p>18-99057 JUNTA TAPA VÁLVULA Reemplaza: 61T-11193-A1 Para: C30(1993-97)</p>	 <p>18-99063 JUNTA CÁRTER INFERIOR Reemplaza: 63V-45315-A0 Para: 9.9(1996-09), 15(1996-09), F9.9(2005-06), F15(1998-05), T9.9(2005-06)</p>	



18-99064

JUNTA ADMISIÓN

Reemplaza: 64E-13645-A0
 Para: 150(1996-99), 200(1996-98), 225(1996-97), D150(1997-99), L150(1996-99), L200(1996-99), P150(1996-99), P175(1996-99), P200(1996-99), S150(1996-99), S175(1996-99), V150(2000-08), V175(2000)

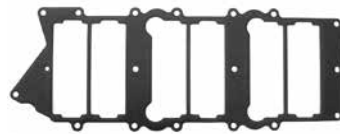

18-99066

JUNTA ADMISIÓN

Reemplaza: 65L-13645-00
 Para: DX150(1999-05), L225(1997-99), L250(1997-99), LX150(1999-01), LX200(1999-01), LX225(2000-03), LX250(2000-03), LZ150(2000-05), LZ200(2000-10), PX150(1999), S225(1997-99), S250(1997-99), SX150(1999-04), SX200(1999-05), SX200(2000-03), SX225(2000-03), SX250(2000-03), V200(1998-99), V225(1998-99), VX150(2000-04), VX200(2000-05), VX225(2000-04), VX250(2002-04), VZ150(2000-10), VZ175(2001-10), VZ200(2001-04), Z150(2000-05), Z175(2001-05), Z200(2000-10)



18-99067

JUNTA ADMISIÓN

Reemplaza: 65L-13646-00
 Para: DX150(1999-05), L225(1997-99), L250(1997-99), LX150(1999-01), LX200(1999-01), LX225(2000-03), LX250(2000-03), LZ150(2000-05), LZ200(2000-10), PX150(1999), S225(1997-99), S250(1997-99), SX150(1999-04), SX200(1999-05), SX200(2000-03), SX225(2000-03), SX250(2000-03), V200(1998-99), V225(1998-99), VX150(2000-04), VX200(2000-05), VX225(2000-04), VX250(2002-04), VZ150(2000-10), VZ175(2001-10), VZ200(2001-04), Z150(2000-05), Z175(2001-05), Z200(2000-10)



18-99068

JUNTA TAPA RESPIRADERO

Reemplaza: 65W-11169-00
 Para: F25(1998-01), T25(2001)



18-99069

JUNTA BASE

Reemplaza: 65W-11351-00
 Para: F25(1998-02), T25(2001-02)



18-99070

JUNTA CARTER

Reemplaza: 65W-11356-00
 Para: F25(1998-05), T25(2001-06)



18-99071

JUNTA

Reemplaza: 65W-14457-10
 Para: F25(1999-05), T25(2001-06)



18-99072

JUNTA ESCAPE

Reemplaza: 65W-41114-00
 Para: F25(1998-05), T25(2001-06)



18-99074

JUNTA BASE

Reemplaza: 66M-11351-10
 Para: F9.9(2005-06), F15(2005), T9.9(2005-06)



18-99075

JUNTA TAPA

Reemplaza: 66M-11356-00
 Para: F9.9(2005-06), F15(1998-05), T9.9(2005-06)



18-99076

JUNTA BOMBA AGUA

Reemplaza: 66M-13329-10
 Para: F9.9(2005-06), F15(2001-05), T9.9(2005-06)



18-99078

JUNTA

Reemplaza: 66M-41138-00
 Para: F15(1998-04)



18-99079

JUNTA CÁRTER SUPERIOR

Reemplaza: 66M-45115-00
 Para: F9.9(2005-06), F15(1998-05), T9.9(2005-06)



18-99080

JUNTA ADMISIÓN

Reemplaza: 676-13646-A0
 Para: C40(1991-97), CV40(1990)

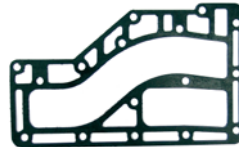

18-99081

JUNTA ESCAPE

Reemplaza: 676-41112-A0
 Para: C40(1991-97), CV40(1990)



18-99082

JUNTA BOMBA AGUA

Reemplaza: 676-44315-A1
 Para: C40(1991-97), CV40(1990)



18-99083

JUNTA BOMBA AGUA

Reemplaza: 676-44324-A0
 Para: C40(1991-97), CV40(1990)



18-99084

JUNTA ESCAPE

Reemplaza: 676-45127-00
 Para: C40(1991-97), CV40(1990)



18-99085

JUNTA ESCAPE

Reemplaza: 676-45128-00
 Para: C40(1991-97), CV40(1990)



18-99086

JUNTA BOMBA AGUA

Reemplaza: 679-44316-A0
 Para: C40(1991-97), CV40(1990)



18-99087

JUNTA CARTER INFERIOR













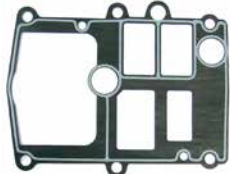
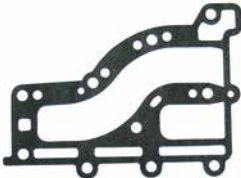



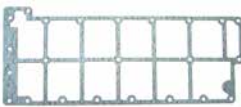
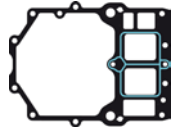

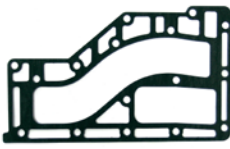

Reemplaza: 679-45315-A0
 Para: C40(1991-94), CV40(1990)

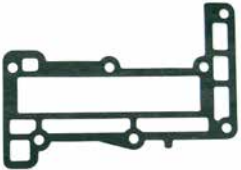

18-99088

JUNTA TAPA

Reemplaza: 67C-11356-00
 Para: F30(2001-05), F40(2000-08)

 <p>18-99089 JUNTA ESCAPE Reemplaza: 67C-41114-00 Para: F30(2001), F40(2000-01)</p>	 <p>18-99091 JUNTA Reemplaza: 67C-45113-00 Para: F25(2001), F30(2001), F40(2000-01), t25(2001)</p>	 <p>18-99095 JUNTA BASE Reemplaza: 682-11351-A0 Para: 9.9(1984-95), 15(1984-95)</p>	 <p>18-99096 JUNTA Reemplaza: 682-41112-A1 Para: 9.9(1984-95), 15(1984-95)</p>	 <p>18-60508 JUNTA TERMOSTATO Reemplaza: 60V-12414-A0-00 Para: Yamaha LZ250(2003-05), LZ300(2004-06), VZ200(2005-09), VZ225(2003-09), VZ250(2003-09), VZ300(2004-09), Z250(2003-05), Z300(2004-06)</p>
 <p>18-99098 JUNTA ADMISIÓN Reemplaza: 688-13621-A1 Para: 90(1992-09), B90(1997-99), C75(1994-99), C80(1997), C85(1992-96), C90(1997-01), E75(1995-00), P75(1996-99)</p>	 <p>18-99099 JUNTA TAPA VÁLVULA Reemplaza: 68F-11193-01 Para: LZ150(2000-05), LZ200(2000-08), VZ150(2000-08), VZ175(2001-08), VZ200(2001-04), Z150(2000-05), Z175(2001-05), Z200(2000-08)</p>	 <p>18-99100 JUNTA Reemplaza: 68F-11381-00 Para: LZ150(2000-05), LZ200(2000-10), VZ150(2000-10), VZ175(2001-10), VZ200(2001-04), Z150(2000-05), Z175(2001-05), Z200(2000-10)</p>	 <p>18-99101 JUNTA ESCAPE Reemplaza: 68F-41114-00 Para: LZ150(2000-05), LZ200(2000-10), VZ150(2000-10), VZ175(2001-10), VZ200(2001-04), Z150(2000-05), Z175(2001-05), Z200(2000-10)</p>	 <p>18-99102 JUNTA BASE Reemplaza: 68F-45113-00 Para: 150(2004-08), DX150(2004-05), LZ150(2000-05), LZ200(2000-08), SX150(2004), SX200(2004-05), V150(2004-08), VX150(2004), VZ150(2000-08), VZ175(2001-08), VZ200(2001-04), Z150(2000-05), Z175(2001-05), Z200(2000-08)</p>
 <p>18-99105 JUNTA ADMISIÓN Reemplaza: 6E5-13621-A1 Para: 115(1992-09), 130(1992-04), 150(1992-09), 175(1992-95, 2000), 200(1992-98), B115(1998-969), C115(1992-00), C150(1996-99), L130(1992-01), L150(1992-99), L200(1992-98), P115(1993-96), P150(1993), S115(1996-99), S130(1996-99), S150(1996-99), S175(1996-99), S200(1996-99)</p>	 <p>18-99106 JUNTA TAPA VÁLVULA Reemplaza: 6E9-11193-A0 Para: C40(1991-97), CV40(1990)</p>	 <p>18-99107 JUNTA ESCAPE Reemplaza: 6E9-41114-A0 Para: C40(1992-97)</p>	 <p>18-99108 JUNTA TAPA VÁLVULA Reemplaza: 6G1-11193-A1 Para: 6(1986-00), 8(1984-09)</p>	 <p>18-99109 JUNTA Reemplaza: 6G1-13621-A1 Para: 6(1991-00), 8(1991-09)</p>
 <p>18-99110 JUNTA ADMISIÓN Reemplaza: 6G1-13645-A1 Para: 6(1991-00), 8(1991-09)</p>	 <p>18-99111 JUNTA ADMISIÓN Reemplaza: 6G1-14198-A1 Para: 6(1986-00), 8(1984-09)</p>	 <p>18-99112 JUNTA ESCAPE Reemplaza: 6G1-41112-A1 Para: 6(1986-00), 8(1984-09)</p>	 <p>18-99113 JUNTA ESCAPE Reemplaza: 6G1-41114-A0 Para: 6(1991-00), 8(1991-09)</p>	 <p>18-99114 JUNTA ESCAPE Reemplaza: 6G1-41133-A0 Para: 6(1992-00), 8(1992-09)</p>
 <p>18-99115 JUNTA BASE Reemplaza: 6G1-45113-A1 Para: 6(1986-00), 8(1984-09)</p>	 <p>18-99116 JUNTA BOMBA AGUA Reemplaza: 6G1-45315-A0 Para: 6(1986-00), 8(1984-09)</p>	 <p>18-99118 JUNTA CARBURADOR Reemplaza: 6G5-14483-A1 Para: C150(1996-99)</p>	 <p>18-99119 JUNTA BASE Reemplaza: 6G8-11351-A0 Para: F9.9(1985-05), FT9.9(1985-90), T9.9(1991-05)</p>	 <p>18-99120 JUNTA TERMOSTATO Reemplaza: 6G8-12414-A0 Para: F6(2001-04), F8(2001-04), F9.9(1985-05, 2007, 2010), FT9.9(1985-90), T8(2001-04), T9.9(1991-05, 2007-10)</p>



18-99121

JUNTA ADMISIÓN

Reemplaza: 6G8-13646-A0
Para: F9.9(1985-05), FT9.9(1985-90), T9.9(1991-05)



18-99122

JUNTA ADMISIÓN

Reemplaza: 6G8-14198-A0
Para: F9.9(1992-05), T9.9(1992-05)



18-99123

JUNTA

Reemplaza: 6G8-15374-00
Para: F9.9(1985-05), FT9.9(1985-90), T9.9(1991-05)



18-99124

JUNTA TERMOSTATO

Reemplaza: 6H3-12414-A1
Para: 60(2001-05), 70(1984-09), C60(1996-01), C70(2000-01), E60(1995-00), P60(1991-99)



18-99125

JUNTA ADMISIÓN

Reemplaza: 6H3-13622-00
Para: 70(1985-91), P60(1991)



18-99126

JUNTA ADMISIÓN

Reemplaza: 6H3-14198-01
Para: 70(1984-91), P60(1991)



18-99128

JUNTA ESCAPE

Reemplaza: 6H3-41114-A0
Para: 60(2001-05), 70(1992-09), C60(1996-01), C70(2000-01), E60(1995-00), P60(1992-99)



18-99129

JUNTA ESCAPE

Reemplaza: 6H3-41112-A0
Para: 60(2001-05), 70(1986-09), C60(1996-01), C70(2000-01), E60(1995-00), P60(1991-99)



18-99130

JUNTA ESCAPE

Reemplaza: 6H3-45113-A0
Para: 60(2001-025), 70(1984-09), C60(1996-01), C70(2000-01), E60(1995-00), P60(1991-99)



18-99132

JUNTA

Reemplaza: 6H4-13621-A1
Para: 40(1984-05), 50(1984-09), C40(1997-03), C50(1998-01), P40(1998), P50(1991-96), PR50(1989), Pro 50(1987-90)



18-99133

JUNTA

Reemplaza: 6H4-14198-01
Para: 40(1989-05), 50(1989-09), C40(1997-03), C50(1998-01), P40(1998), P50(1991-96), PR50(1989), Pro 50(1989-90)



18-99134

JUNTA

Reemplaza: 6H4-15369-A1
Para: 40(1984-01), 50(1984-09), C40(1997-03), C50(1998-01), P40(1998), P50(1991-96), PR50(1989), Pro 50(1987-90)

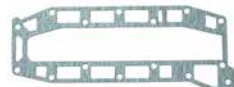

18-99135

JUNTA ESCAPE

Reemplaza: 6H4-41112-A0
Para: 40(1992-05), 50(1992-09), C40(1997-03), C50(1998-01), P40(1998), P50(1992-96)



18-99136

JUNTA ADMISIÓN

Reemplaza: 6K7-13646-A1
Para: 225(1990-95), P150(1994-95), P175(1994-95), P200(1992-95), V6 Excel(1987-89)



18-99137

JUNTA ESCAPE

Reemplaza: 6L2-41133-A2
Para: 25(2004-08)



18-99138

JUNTA BOMBA AGUA

Reemplaza: 6L2-45315-A0
Para: 20(1996-97), 25(1992-09)

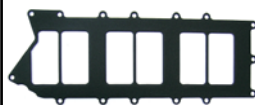

18-99139

JUNTA ADMISIÓN

Reemplaza: 6OV-13646-00
Para: LZ250(2003-05), LZ300(2004-06), VZ200(2005-09), VZ225(2003-09), VZ250(2003-09), VZ300(2004-09), Z250(2003-05), Z300(2004-06)



18-99140

JUNTA CULATA

Reemplaza: 63V-11181-A1, 63V-11181-A2
Para: 9.9(1997-08), 15(1997-08)



18-99141

JUNTA TAPA

Reemplaza: 6H3-11193-A1
Para: 60(2001-05), 70(1984-09), C60(1996-01), C70(2000-01), E60(1995-00), P60(1991-99)



18-99142

JUNTA TERMOSTATO

Reemplaza: 6E9-12414-A0, 6E9-12414-A1
Para: C40(1992-97)



18-99143

JUNTA VÁLVULA

Reemplaza: 6H3-13621-A1
Para: 60(2001-05), 70(1992-09), C60(1996-01), C70(2000-01), E60(1995-00), P60(1992-99)



18-99144

JUNTA TAPA MEZCLADO

Reemplaza: 6E7-14227-00
Para: 9.9(1984-95), 15(1984-95)



18-99145

JUNTA CARBURADOR

Reemplaza: 677-14198-00, 677-14198-A1
Para: 9.9(1984-91), 15(1984-91)



18-99147

JUNTA BOMB. COMB.

Reemplaza: 6G1-24431-01
Para: 3(1990-02), 6(1990-00), 8(1990-09), 9.9(1996-09), 15(1996-09)

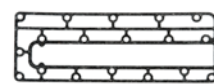

18-99148

JUNTA TAPA ESCAPE

Reemplaza: 688-41114-A0
Para: 90(1992-09), B90(1998-99), C75(1994-99), C80(1997), C85(1992-96), C90(1997-01), E75(1995-00), P75(1996-99)

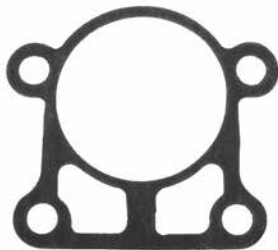

18-99149
JUNTA BOMBA AGUA
 Reemplaza: 663-44316-A0
 Para: 25(1997-02), 30(1992-01), 40(1992-94), 50(1992-94), C30(1995), C55(1992-95), E48(1995-00), P50(1992-94)

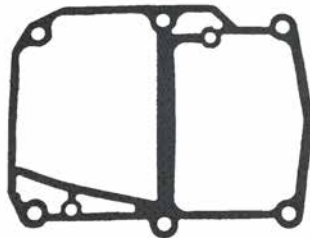

18-99150
JUNTA CÁRTER SUPERIOR
 Reemplaza: 63V-45113-A1
 Para: 9.9(1997-09), 15(1997-09)

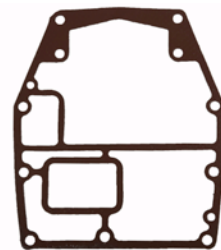

18-99151
JUNTA CÁRTER SUPERIOR
 Reemplaza: 688-45113-A0
 Para: 90(1984-09), B90(1997-99), C75(1994-99), C80(1997), C85(1991-96), C90(1997-01), C85(1989-90), E75(1995-00), P75(1996-99)



18-99152
JUNTA CÁRTER INFERIOR
 Reemplaza: 683-45315-A0
 Para: 9.9(1984-95), 15(1984-95), F9.9(1986-05)

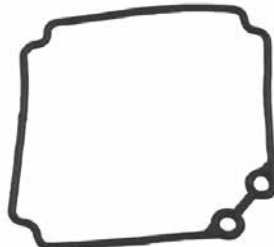

18-0765
JUNTA COMANDA FLOTACIÓN
 Reemplaza: 6L2-14384-00-00

Pack. de 2



18-0775
18-0775-9^①
JUNTA MONTAJE
 Reemplaza: 648-14198-A0-00



18-0785
JUNTA MONTAJE CARBURADOR
 Reemplaza: 6E5-14198-A1-00



18-0786
JUNTA CAMARA FLOTACIÓN
 Reemplaza: 6E5-14384-02-00



18-2592
JUNTA FLOTADOR
 Reemplaza: 6E5-14384-03-00
 Para: V-4 Fuerabordas: 115, 130, 150, 175, 200, 225 (1986-96) V-6 Especial & Excel (1986-89)



18-0840-1
JUNTA CAMARA FLOTACIÓN
 Reemplaza: 676-14984-00-00

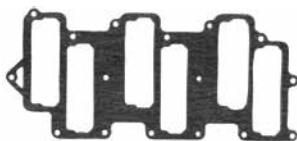



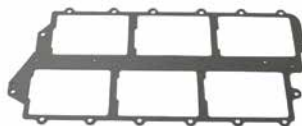







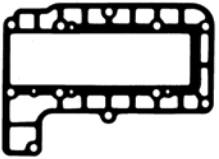
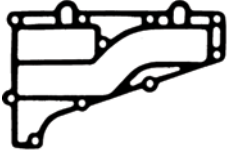



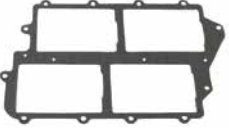
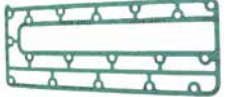
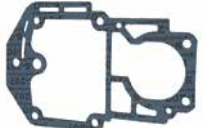





18-0807-1
JUNTA
 Reemplaza: 6K7-13645-A1-00





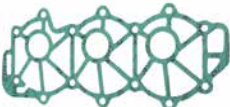

18-0809
JUNTA
 Reemplaza: 6G5-13645-A1-00











18-64415
O₂ KIT SENSOR
 Reemplaza: 68F-W1135-00-00
 Para: Yamaha DX150(2001-05), LX150(2001), LX200(2001), LX225(2001-02), LX250(2001-02), LZ150(2000-05), LZ200(2000-12), SX150(2001-04), SX200(2001-05), SX225(2001-02), SX250(2001-02), VX150(2001-04), VX200(2001-02), VX225(2001-02), VZ150(2000-14), VZ175(2001-12), VZ200(2001-04), Z150(2000-05), Z175(2001-05), Z200(2000-12)

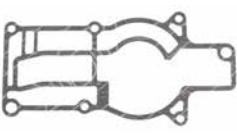
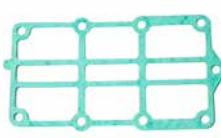

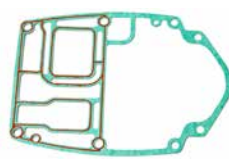

 <p>18-0808 JUNTA VÁLVULA PRESIÓN Reemplaza: 6G5-11382-A1-00</p>	 <p>18-0250 JUNTA TAPA ESCAPE Reemplaza: 664-41114-A0-00</p>	 <p>18-0743 JUNTA TAPA ESCAPE Reemplaza: 6L2-41112-A1-00</p>	 <p>18-0744 JUNTA TAPA ESCAPE Reemplaza: 6L2-41114-A1-00</p>	 <p>18-0798 JUNTA TAPA ESCAPE Reemplaza: 6H4-41114-A0-00</p>
 <p>18-0799 JUNTA TAPA ESCAPE Reemplaza: 6E5-41112-A1-00</p>	 <p>18-0812 JUNTA TAPA ESCAPE Reemplaza: 6G5-41112-A1-00</p>	 <p>18-0823 JUNTA TAPA ESCAPE Reemplaza: 6E5-13645-A1-00</p>	 <p>18-0847 JUNTA TAPA ESCAPE Reemplaza: 688-41112-A0-00 Para: 90 HP</p>	 <p>18-0739 JUNTA SUPERIOR Reemplaza: 689-45113-A1-00</p>
 <p>18-0813 JUNTA BASE Reemplaza: 6G5-45113-A0-00</p>	 <p>18-0232 JUNTA TAPA Reemplaza: 655-12414-A1-00</p>	 <p>18-0782 JUNTA TAPA Reemplaza: 6E5-11381-A1-00</p>	 <p>18-0829 JUNTA TAPA Reemplaza: 61A-12414-A0-00 6J8-12414-A0-00</p>	 <p>18-0754 JUNTA TERMOSTATO Reemplaza: 68D-E2414-A0-00 Para: F2.5MSH-0405, F2.5MSH-0406, F2.5MSH-0407, F2.5MSH0608, F2.5MSHD-2007</p>
 <p>18-0835 JUNTA TERMOSTATO Reemplaza: 62Y-12414-00-00 Para: F 9.9, T9.9 (2005-06), 15 (2006), F15, F25 (1998-06), T25, F30 (2001-06), F40 4cil (1999), F40 3cil (2000-06), F50 (1996-06), T50 (1996-06), F60 (2002-06), T60 (2003-06)</p>	 <p>18-0836 JUNTA TERMOSTATO Reemplaza: 682-12414-A1-00 Para: 9.9, 15 (1984-06)</p>	 <p>18-0844 JUNTA TERMOSTATO Reemplaza: 688-12414-A1-00 Para: 90 HP V-4, V-6</p>	 <p>18-0767 JUNTA Reemplaza: 688-11193-01-00 Para: 90 HP</p>	 <p>18-0779 JUNTA Reemplaza: 6G5-11193-A0-00</p>
 <p>18-0781 JUNTA Reemplaza: 6E5-11193-A0-00</p>	 <p>18-0815 JUNTA Reemplaza: 6H4-11193-A1-00</p>	 <p>18-0483 JUNTA BOMBA Reemplaza: 63D-44316-00-00 Para: 40 (1995-04), 50 (1995-97, 1999-04)</p>	 <p>18-0753 JUNTA BOMBA AGUA Reemplaza: 6G1-44315-A0-00 Para: 6 (1986-00), 8 (1984-05)</p>	 <p>18-0239 JUNTA BOMBA AGUA Reemplaza: 688-44315-A0-00</p>

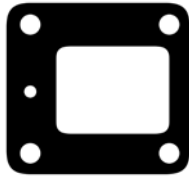
 <p>18-60512 JUNTA Reemplaza: 68D-E1169-A0-00 Para: Yamaha F4(2002-08)</p>	 <p>18-60521 JUNTA TAPA CILINDRO Reemplaza: 69M-11196-A0-00 Para: Yamaha F2.5(2003-14), F4(1999-14), F6(2009-14)</p>	 <p>18-60529 JUNTA COLECTOR ESCAPE Reemplaza: 66T-41133-A0-00 Para: Yamaha T40/T30 Enduro Series</p>	 <p>18-63966 JUNTA CULATA CILINDRO Reemplaza: 66M-11181-10-00 Para: Yamaha F9.9(2005-06), F15(2005-06), T9.9(2005-06)</p>	 <p>18-63968 JUNTA CULATA CILINDRO Reemplaza: 65W-11181-30-00 Para: F25(2005), T25(2005-06)</p>
---	--	--	---	---

 <p>18-60513 JUNTA Reemplaza: 66M-11357-00-00 Para: Yamaha F9.9(2005-06), F15(1998-06), T9.9(2005-06)</p>	 <p>18-60522 JUNTA TAPA CILINDRO Reemplaza: 66T-11181-A0-00 Para: Yamaha F2.5(2003-14), F4(1999-14), F6(2009-14)</p>	 <p>18-60530 JUNTA TAPA ESCAPE Reemplaza: 66M-41114-01-00 Para: Yamaha F9.9(2005-06), F15(2005-06), T9.9(2005-06)</p>	 <p>18-60531 JUNTA TAPA ESCAPE Reemplaza: 65W-41114-01-00 Para: Yamaha F25</p>
--	---	---	---

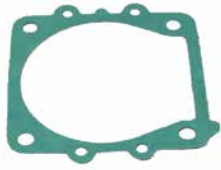
 <p>18-60523 JUNTA TAPA CILINDRO Reemplaza: 69M-11181-00-00 Para: Yamaha F2.5(2003 & Sup)</p>	 <p>18-60519 JUNTA TAPA CILINDRO Reemplaza: 68D-E1193-A0-00 Para: Yamaha F4(2002-08)</p>	 <p>18-60527 JUNTA MOTOR Reemplaza: 67D-45113-A0-00 Para: Yamaha F4(1999-08)</p>	 <p>18-60532 JUNTA TAPA ESCAPE Reemplaza: 66T-41114-A0-00 Para: Yamaha T40/T30 Enduro Series</p>	 <p>18-60520 JUNTA TAPA CILINDRO Reemplaza: 66T-11193-A0-00 Para: Yamaha T40/T30 Enduro Series</p>
---	--	--	--	--

 <p>18-60528 JUNTA MOTOR Reemplaza: 66T-45113-A0-00 Para: Yamaha T40/T30 Enduro Series</p>	 <p>18-60534 JUNTA COLECTOR Reemplaza: 66M-13645-00-00 Para: Yamaha F9.9(2005-06), F15(1998-06), T9.9(2005-06)</p>	 <p>18-60535 JUNTA COLECTOR Reemplaza: 65W-13645-00-00 Para: F25(1998-05), T25(2001-06)</p>	 <p>18-60540 JUNTA TERMOSTATO Reemplaza: 676-12414-A0-00 Para: Yamaha T40/T30 Enduro Series</p>	 <p>18-60541 JUNTA TAPA BOMBA AGUA Reemplaza: 6BX-G4315-01-00 Para: F4(2009-14), F6(2009-14)</p>
---	---	--	--	---

 <p>18-0240 JUNTA BOMBA DE AGUA Reemplaza: 688-44316-A0-00</p>	 <p>18-0244 JUNTA BOMBA DE AGUA Reemplaza: 6E5-44315-A0-00</p>	 <p>18-0292 PLATINA A JUNTA BASE BOMBA Reemplaza: 663-44315-</p>	<p>Pack. de 2</p>  <p>18-0294 18-0294-9 ① PLATINA A JUNTA BASE BOMBA Reemplaza: 663-44324-A0-00</p>	 <p>18-0756-1 JUNTA BOMBA DE AGUA Reemplaza: 6H3-44315-A0-00</p>
---	---	---	---	---

 <p>18-0757 JUNTA PLATINA Reemplaza: 6H3-44324-A0-00</p>	<p>Pack. de 2</p>  <p>18-0768 18-0768-9 ① JUNTA PLATINA Reemplaza: 682-44315-A0-00</p>	 <p>18-0826 JUNTA TORNILLO DRENAJE Reemplaza: 90430-14115-00 Para: 40-90 HP</p>	 <p>18-1079 RETÉN ACEITE PROTECTOR Reemplaza: 6A1-44325-00-00 Para: 2(1984-85, 1988-89)</p>
---	--	--	---

MIRAR PÁGINAS 199-200 PARA VER LINEAS COMPLETAS DE JUNTAS SELLADORAS

 <p>18-4274 ESPACIADOR HÉLICE Reemplaza: 688-45997-01-00</p>	 <p>18-2448 KIT INFERIOR DE LLENADO Y VACIADO M8 - 1.25 Dientes Para: Yamaha, Nissan/Tohatsu, & Honda parte inferior</p>	 <p>18-4698 18-46981-9① (Pack. de 50) ARAND. DRENAJE/ LLENADO Reemplaza: 90430-08020-00</p>	 <p>18-2371 18-23711-9 ① (Pack. de 50) TORNILLO DRENAJE M8 - 1.25 Dientes Reemplaza: 90340-08002-00, 90340-08M04-00 Use Junta 18-4698</p>	 <p>18-2374 18-23741-9 ① (Pack. de 50) TORNILLO DRENAJE MAGNÉTICO M8 - 1.25 Dientes Reemplaza: 688-45341-00-00, 688-45341-10-00 Use junta 18-4698</p>
---	---	---	--	---





 <p>18-2388 EJE HÉLICE Reemplaza: 688-45611-00-00 Para: F40 (1999) F50(1999-00) C60/C70/ C90 (2000-01) C75 (1994) C85 (1991-94)</p>	 <p>18-2385 EJE HÉLICE Reemplaza: 6E5-45611-01-00 Para: 115/130HP</p>	<p style="text-align: center;">MUELLE</p>  <p>18-51001 Reemplaza: 63V-15713-00-00 Para: 9.9(1996-09), 15(1996-09), F6(2001-08), F8(2001-14), F9.9(2005-14), F15(1998-14), F20(2006-14), T8(2002-10), T9.9(2007-14)</p>	 <p>18-51002 Reemplaza: 67D-15713-00-00 Para: F2.5(2003-14), F4(1999-14), F6(2009-14)</p>	 <p>18-51003 Reemplaza: 66T-15713-00-00 Para: F25(2009-14), F30(2001-05), F40(2001-08)</p>
---	---	---	--	--

Modelo	Año	Ref #	Modelo	Año	Ref #
40EJRP - 50TLHS	1984-1997	N/D	F115TLR	2006 & SUP	18-2385
50ETSN - 50TLHS	1984-1994	N/D	F115TLRA - F115TLRZ	2001-2005	18-2385
T50TLRY - C90TLRZ	1989-2001	18-2388	F115TXR	2006 & SUP	18-2385
50ETSK	1984-2001	18-2385	F115TXRA -200ETXN	1984-2004	18-2385
115TLR	2006 & SUP	18-2385	V-6 SPECIAL	1985-1986	18-2385
115TLRA - 115TRR	1991-2005	18-2385	V-6 SPECIAL L	1984-1986	18-2385
115TXR	2006 & SUP	18-2385	V-6 SPECIAL LK	1985	18-2385
115TXRA - 115TXRA	1991-2005	18-2385	V-6 SPECIAL X	1984-1986	18-2385
F115TJR	2006 & SUP	18-2385	V-6 SPECIAL XK	1985	18-2385
F115TJRA - F115TJRD	2002-2005	18-2385			

 <p>18-2773 ALOJAMIENTO COJINETE Reemplaza: 663-45331-00-94 Para: E48 (1995, 1997-00) / C55 (1991-95)</p>	 <p>18-2782 ALOJAMIENTO COJINETE Reemplaza: 688-45331-00-94 Para: F40 (1999) F50/T50 (1996-00) 60 (2002-03) C60 (1996-01) E60 (1995-99) P60 (1991-99) 70 (1984-03) C70 (2000-01) C75 (1994-96 / 1998-99) E75 (1995-00) P75 (1996-99) C80 (1997) C85 (1991-96)</p>
--	--

① Precio por Pack

Zinc para aplicaciones en agua salada.
Magnesio solo para aplicaciones en agua dulce.
Aluminio para aplicaciones en agua dulce y salada.

 <p>18-6118A^① ANODO CILINDRO Reemplaza: 68V-11325-01-00 Para: F75-F250 / 2004 hasta Abril 2006</p>	 <p>18-6119A^① 18-6119Z^③ ANODO Reemplaza: 61A-45371-00-00</p>	 <p>18-6120A^① 18-6120Z^③ ANODO Reemplaza: 61N-45251-01-00</p>	 <p>18-6121A^① 18-6121Z^③ ANODO Reemplaza: 6K1-45371-02-00 Para: FL150 (2004-2005); L150 - L200 (1987-2002)</p>	 <p>18-6122A^① 18-6122Z^③ ANODO Reemplaza: 69L-45371-00-00 Para: VZ200 - VZ300 / 3.3L (2005-Actual), VX225 - VX250 / 2.6L (2002-2005), Z250 - Z300 / 3.3L (2004-Actual)</p>															
 <p>18-6246 TORNILLO TRIM Reemplaza: 90105-10M00-00 M10 - 1.25 x 45mm dientes</p>	 <p>③ 18-6034 ANODO Reemplaza: 6K1-45371-00-00 Para usar en la medida inferior 150,200 HP (1986)</p>	 <p>② 18-6112 ③ 18-6035 ANODO Reemplaza: 6J9-45371-01-00 Para: 150-200 HP</p>	 <p>② 18-6111 ③ 009355 ANODO Reemplaza: 688-45371-02-00 Para uso en la unidad inferior Para: 60, 70, 90HP (1984-04) C60, C75, C85, C90 (1994-01), E60, E75 (1995-00), F50 (1996-00), P60, P75 (1991-99), T50 (1996-00)</p>	 <p>③ 025841 ANODO Reemplaza: 6G5-45251-01-00 Para soporte transom Para: 115-225HP (1988-02)</p>															
 <p>③ 18-6091 ANODO Reemplaza: 6H1-45251-02-00 Para: 40-90 HP</p>	 <p>③ 009357 ANODO Reemplaza: 664-45371-01-00 Para: 20-50 HP</p>	 <p>③ 025304 ANODO Reemplaza: 6E5-45371-01-00 Para uso de unidad inferior Para: 115, 130 HP(1984-04), V6 especial (1985-86)</p>	 <p>② 18-6132A ③ 18-6132M ANODO Para: Yamaha 200-250 Fueraborda</p>	 <p>② 18-6133A ③ 18-6133M ANODO Para: Yamaha 150-200 Fueraborda</p>															
 <p>NEW</p> <p>18-6162A^① 18-6162M^② ANODO KIT Para: Yamaha 60-90HP motor</p>	 <p>PASADOR</p> <table border="1"> <thead> <tr> <th>Ref #</th> <th>O.E. #</th> <th>Pack de</th> </tr> </thead> <tbody> <tr> <td>18-2380</td> <td>91490-30030-00, 91401-30030-00, 91401-30028-00, 91402-30028-09, 91402-30022-00</td> <td>10</td> </tr> <tr> <td>18-3735</td> <td>91490-40030-00</td> <td>10</td> </tr> <tr> <td>18-3748</td> <td>91490-30045-00</td> <td>5</td> </tr> <tr> <td>18-73893</td> <td>91490-25030-00</td> <td>1</td> </tr> </tbody> </table>		Ref #	O.E. #	Pack de	18-2380	91490-30030-00, 91401-30030-00, 91401-30028-00, 91402-30028-09, 91402-30022-00	10	18-3735	91490-40030-00	10	18-3748	91490-30045-00	5	18-73893	91490-25030-00	1	 <p>18-73891 ESPACIADOR HÉLICE Reemplaza: 68D-G5987-00-00 Para: Yamaha F2.5(2001 & Sup), F4(2001 & Sup), F6(2006 & Sup)</p>	 <p>18-73914 ESPACIADOR HÉLICE Reemplaza: 670-45997-02-00 Para: Yamaha 40-50(1984-05)</p>
Ref #	O.E. #	Pack de																	
18-2380	91490-30030-00, 91401-30030-00, 91401-30028-00, 91402-30028-09, 91402-30022-00	10																	
18-3735	91490-40030-00	10																	
18-3748	91490-30045-00	5																	
18-73893	91490-25030-00	1																	
 <p>18-73918 ARANDELA HÉLICE Reemplaza: 63P-45987-00-00, 6E5-45987-01-00 Para: Yamaha F115-F200(2004-14)</p>	 <p>18-73979 ARANDELA HÉLICE Reemplaza: 6L2-45987-01-00 Para: Yamaha 25(1988-09), 30(1990-02), C30(1994-97), F25(1998-14)</p>	 <p>18-73978 ARANDELA TUERCA HÉLICE Reemplaza: 90201-08M54-00 Para: Yamaha Multiple Aplicaciones</p>	 <p>18-73990 KIT TUERCA HÉLICE Para: Yamaha 40(1984-01), 50(1984-95), C55, F40-F50(1995-00)</p>	 <p>18-73993 KIT TUERCA HÉLICE Para: Yamaha F9.9/15</p>															



**18-73994
KIT TUERCAS HÉLICE**
Para: Yamaha F2.5/F4(2001 & sup),
F6(2006 & sup)



**18-73892
TUERCAS HÉLICE**
Reemplaza: 6L5-45616-00-00
Para: Yamaha 2.5-6(1988 & Sup)



18-3781D
KIT TUERCAS HÉLICE
Reemplaza: 6H1-W4599-00-00
Para: T50, C60, E60, P60, 70, C75, C80, C85, 90
— **CONTIENE** —

Ref #	O.E. #	Descripción
18-3732	90171-16011-00	Tuerca
18-4274	688-45997-01	Espaciador
18-2380	91490-30030	Pasador



18-3782D
KIT TUERCAS HÉLICE
Reemplaza: 6G5-W4599-00-00
— **CONTIENE** —

Ref #	O.E. #	Descripción
18-3726	90171-18M04	Tuerca
18-4274	688-45997-01	Espaciador
18-3735	91490-40030	Pasador

Todos V-4 & V-6 (Excepto D150)



**18-3771
KIT TUERCAS HÉLICE**
Reemplaza: 689-W4599-00
— **CONTIENE** —

Ref #	O.E. #	Descripción
18-3791	689-45997-00	Espaciador
18-3792	90171-14013-00	Tuercas hélice
18-2380	91490-30030-00	Pasador



**18-3709
TUERCAS HÉLICE**
Reemplaza: 647-45616-02
Para: 4(1984-91), 5(1984-85)



**18-3726
TUERCAS HÉLICE**
Reemplaza: 90171-18M04
Para: Todos V-4 & V-6 (Excepto D150)



**18-3732
TUERCA HÉLICE**
Reemplaza: 90171-16011-00
95307-16900-00
Para: Yamaha 20-30 hp(1980 & Sup)



**18-3773
TUERCA HÉLICE**
Reemplaza: 90171-10M01
Para: 6(1986-00), 8(1986-09), 9.9(1984-09),
15(1984-09), F6(2001-08), F8(2001-12),
F9.9(1985-12), F15(1998-13), F20(2006-13)



**18-3791
ESPACIADOR**
Reemplaza: 689-45997-00



**18-3792
TUERCA HÉLICE**
Reemplaza: 90171-14013-00,
90171-14056-00



**18-79989
STICKS ARRASTRE**
Para: Mayoría de fueraborda 150hp con integral tilt/trim.

HP/Modelo	Año	Tuerca #	Espaciador #	Pasador #	Kit #
2(6A1)	1984-95	—	—	18-3748	—
4(6E0)	1984-90	—	—	18-3748	—
4(6E0)	1991	—	—	18-2380	—
5	1984-85	—	—	18-3748	—
9.9(6GB)	1984-85	—	—	18-3748	—
20	1996-97	18-3792	18-3791	18-2380	18-3771
25(6H7)(6L2)	1984-09	18-3792	18-3791	18-2380	18-3771
C25(695)	1991-97	18-3792	18-3791	18-2380	18-3771
CV25	1990	18-3792	18-3791	18-2380	18-3771
F25	1998-05, 2009-10	18-3792	18-3791	18-2380	18-3771
30(689)(6J8)	1984-02	18-3792	18-3791	18-2380	18-3771
C30(689)(61T)	1991-97	18-3792	18-3791	18-2380	18-3771
CV30	1990	18-3792	18-3791	18-2380	18-3771
40(6H4)(63B,C,D)	1984-05	18-3732	—	18-2380	—
C40(6R6)	1990-03	18-3732	—	18-2380/18-3748	—
50(6H5)(62X)	1984-09	18-3732	—	18-2380/18-3748	—
PRO50(6H5)(62X)	1987-90	18-3732	—	18-2380	—
T50	2001-10	18-3732	18-3789	18-3735	18-3772
C55(697)	1991-95	18-3732	—	18-3735	—
60	2004-05	18-3732	18-3789	18-3735	18-3772
P60(6H2)	1991-99	18-3732	18-4274	18-3735	18-3781
T60	2003-10	18-3732	18-3789	18-3735	18-3772
70(6H3)	1984-03	18-3732	18-4274	18-3735	18-3781
70	2004-09	18-3732	18-3789	18-3735	18-3772
F70	2010	18-3732	18-3789	18-3735	18-3772
C75(692)	1994-99	18-3732	18-4274	18-3735	18-3781
F75	2003-10	18-3732	18-3789	18-3735	18-3772
F80	1999-03	18-3732	18-3789	18-3735	18-3772
C85(688)	1991-96	18-3732	18-4274	18-3735	18-3781
90(6H1)	1984-03	18-3732	18-4274	18-3735	18-3781
90	2004-09	18-3732	18-3789	18-3735	18-3772
F90	2003-10	18-3732	18-3789	18-3735	18-3772
F100	1999-03	18-3732	18-3789	18-3735	18-3772
115(6E5)(6N6)	1984-09	18-3726	18-4274	18-3735	18-3782
C115(6E5)	1991-00	18-3726	18-4274	18-3735	18-3782
P115(62A)	1993-96	18-3726	18-4274	18-3735	18-3782
130(6L1)(6N7)	1988-04	18-3726	18-4274	18-3735	18-3782
L130(6L6)(6N4)	1989-01	18-3726	18-4274	18-3735	18-3782
150(6G4)(6R2)	1984-09	18-3726	18-4274	18-3735	18-3782
PRO V 150, (6J9)(6N9)	1986-90	18-3726	18-4274	18-3735	18-3782
P150(6N9)	1991-99	18-3726	18-4274	18-3735	18-3782
L150(6RO)	1986-99	18-3726	18-4274	18-3735	18-3782
175(6G5)(6R3)	1984-00	18-3726	18-4274	18-3735	18-3782
P175(62H)	1994-99	18-3726	18-4274	18-3735	18-3782
200(6G6)(6R4)	1984-95	18-3726	18-4274	18-3735	18-3782
L200(6K1)(6R1)	1987-99	18-3726	18-4274	18-3735	18-3782
P200(61H)	1991-99	18-3726	18-4274	18-3735	18-3782
225(6R5)(62J)	1990-97	18-3726	18-4274	18-3735	18-3782
L225(62K)	1994-99	18-3726	18-4274	18-3735	18-3782
250(61A)	1990-95	18-3726	18-4274	18-3735	18-3782
L250(61B)	1990-99	18-3726	18-4274	18-3735	18-3782
V6 SPECIAL(6G7)	1984-86	18-3726	18-4274	18-3735	18-3782
V6 EXCEL(6K7)	1987-89	18-3726	18-4274	18-3735	18-3782

① Referencias acabadas en "D" Envasadas

② Precio por pieza. Precio pack, añadir -9 a la referencia.

PERFECT FIT MANIFOLDS

Perfect fit, quality assured replacement manifolds for all major OEM engine manufacturers.

All Sierra's Manifolds

- Manufactured as a direct OE replacement and are fully interchangeable with the OEM products they are designed to replace.
- Includes all the necessary gaskets and hardware for easy installation.
- All manifolds are primed and painted for added durability and protection.
- Components are ready to install out-of-the box.
- Packaged for maximum protection during shipping and handling.
- Backed by Sierra's Comprehensive Warranty.



Explore

www.seastarsolutions.com

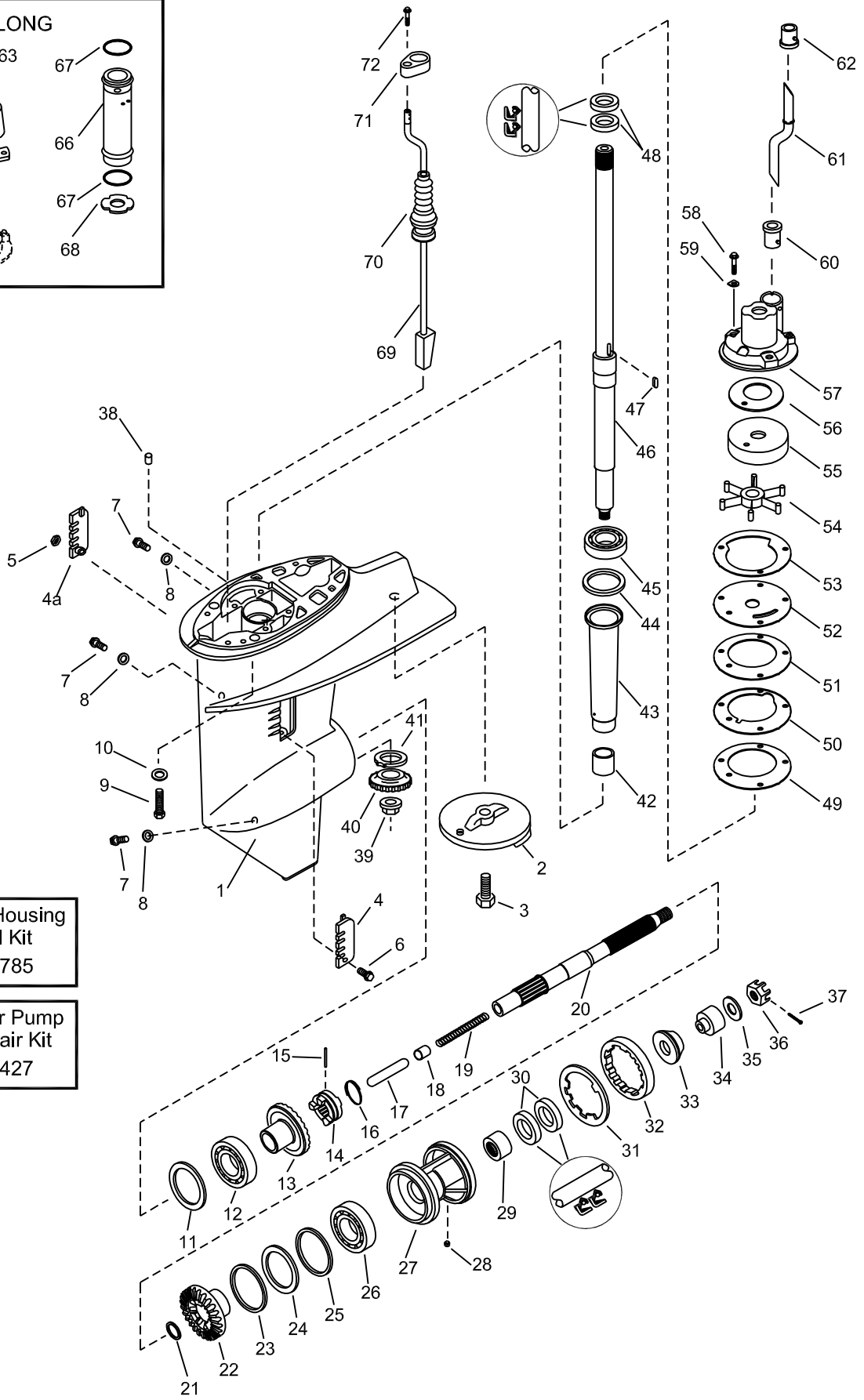
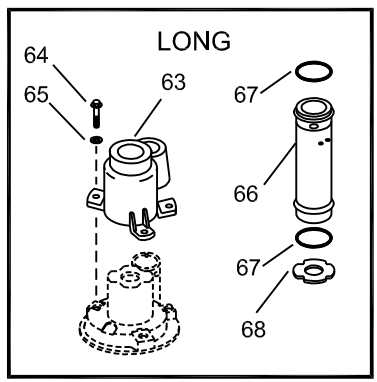
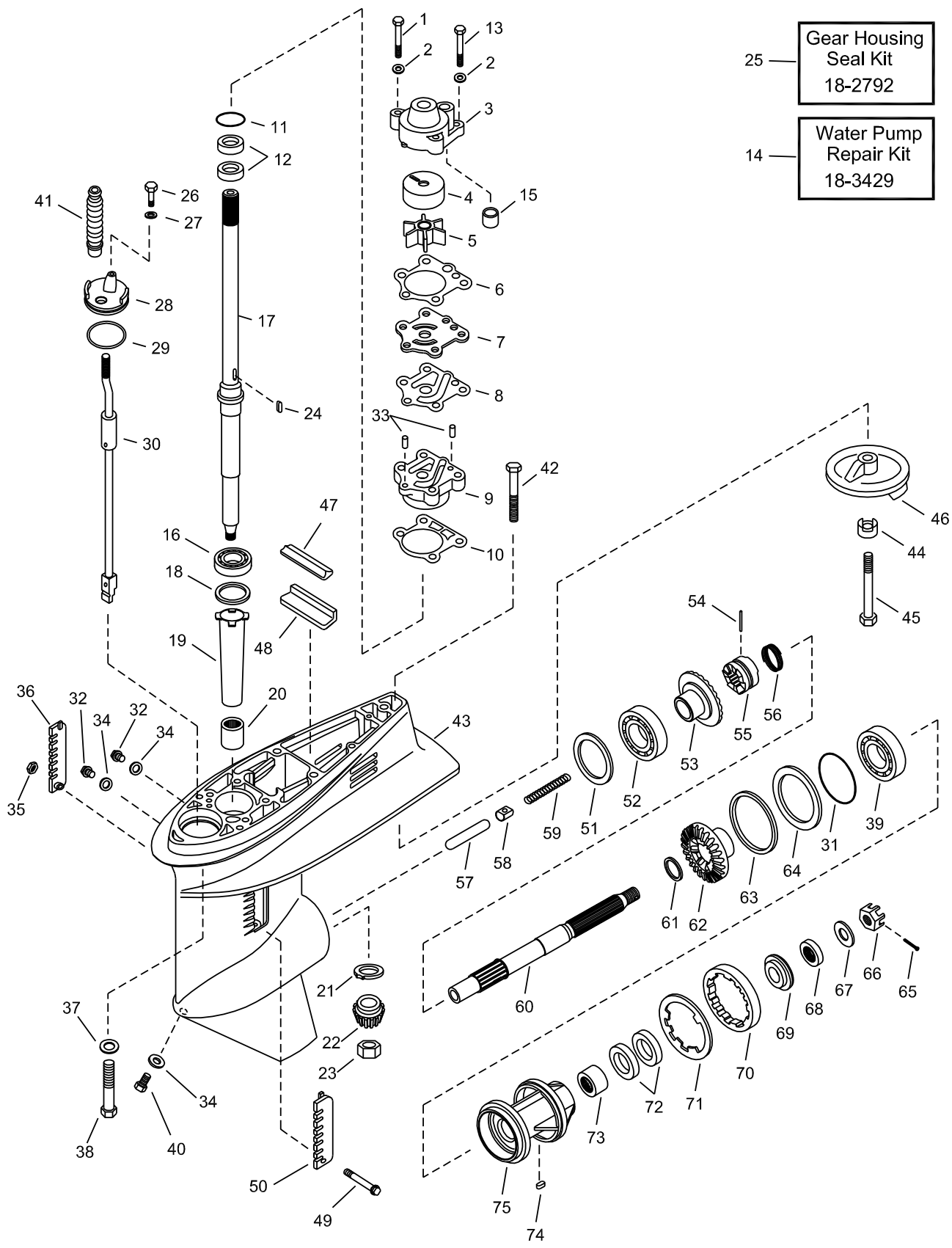

Fig. #	Descripción	Ref #	O.E.M. #	Cant.	Fig. #	Descripción	Ref #	O.E.M. #	Cant.
1	Alojamiento	—	689-45311-04-EK3	1	37	Pasador	18-2380	91490-30030-00	
2	Tapón	18-6096A, 18-6113	664-45371-01-00	1	38	Pasador	—	93606-12019-00	2
					39	Tuerca, Piñon	—	90179-09M02-00	2
3	Tornillo Trim Tab	—	90105-08M02-00	1	40	Engranajes, Piñon	—	689-45551-00-00	1
4	Tapón, Entrada agua (babor)	—	689-45214-01-01	1	41	Cojinete, empuje	—	664-45552-09-00	1
4a	Tapón, Entrada de agua (Estr.)	—	689-45215-01-00	1	42	Cojinete, Piñon	—	93315-017U4-00	1
5	Tuerca, Nylock	—	90185-05904-00	1	43	Casquillo	—	689-45536-00-00	1
6	Tornillo, Entrada de agua	—	98680-05525-00	1	44	Engranaje piñón (0.5mm)	—	664-45587-00-05	AR
7	Tapón, Drenaje & Vent.	—	90340-08M04-00	3		Engranaje piñón (0.8mm)	—	664-45587-00-08	AR
8	Junta, Tapón	—	90430-08020-00	3		Engranaje piñón (0.12mm)	—	664-45587-01-12	AR
9	Tornillo, Caja engranajes montaje	—	90105-10059-00	2		Engranaje piñón (0.30mm)	—	664-45587-01-30	AR
10	Arandela, Caja engranaje	—	92990-10600-00	4		Engranaje piñón (0.50mm)	—	664-45587-01-50	AR
11	Engranaje delantero (0.5mm)	—	664-45567-00-05	AR	45	Cojinete, Eje transmisión	—	93332-000U4-00	1
	Engranaje delantero (0.8mm)	—	664-45567-00-08	AR	46	Eje transmisión (largo)	—	689-45501-10-00	1
	Engranaje delantero (0.12mm)	—	664-45567-01-12	AR	47	Llave, Impulsor	—	664-44338-00-00	1
	Engranaje delantero (0.30mm)	—	664-45567-01-30	AR	48	Retén aceite, Base bomba	18-0296	93101-22067-00	2
	Engranaje delantero (0.50mm)	—	664-45567-01-50	AR	49	Junta, Base	18-0773	689-44316-A0-00	1
12	Cojinete, engranaje delantero	—	93332-00005-00	1	50	Base, bomba agua	—	689-44325-02-5B	1
13	Engranaje, delantero	—	689-45560-00-00	1	51	Junta, Base	18-0773	689-44316-A0-00	1
14	Acoplamiento	—	664-45631-01-00	1	52	Impulsor platina	—	689-44323-03-00	1
15	Pasador	—	90250-05010-00	1	53	Junta, Impulsor platina	—	689-44324-A0-00	1
16	Aro	—	648-45633-00-00	1	54	Impulsor	18-3067	689-44352-02-00	1
17	Embolo	—	648-45635-00-00	1	55	Casquillo	18-3439	689-W4432-02-00	1
18	Arandela	—	648-45634-00-00	1	56	Damper, Retén agua	—	689-44367-01-00	1
19	Muelle, Compresión	—	90501-10065-00	1	57	Alojamiento, Bomba agua	—	689-44311-03-00	1
20	Eje, hélice	—	689-45611-00-00	1	58	Tornillo, bomba alojamiento	—	90101-06M56-00	3
21	Empuje, Arandela, Prop Shaft	—	90201-20417-00	1	59	Arandela, Alojamiento (eje corto)	—	90209-06M04-00	3
22	Engranaje, Reverso	—	689-45571-00-00	1	60	Retén, tubo inf agua	—	626-44365-01-00	1
	Engranaje reverso (0.5mm)	—	664-45577-00-05	AR	61	Tubo agua (Eje largo)	—	689-44361-10-00	1
	Engranaje reverso (0.8mm)	—	664-45577-00-08	AR	62	Retén, tubo agua superior	18-0552	689-44366-00-00	1
	Engranaje reverso (0.12mm)	—	664-45577-01-12	AR	63	Extensión, Alojamiento (eje largo)	—	689-44312-00-5B	1
	Engranaje reverso (0.30mm)	—	664-45577-01-30	AR	64	Tornillo, Extensión (eje largo)	—	97080-06035-00	3
	Engranaje reverso (0.50mm)	—	664-45577-01-50	AR	65	Arandela, tornillo (Eje largo)	—	92990-06600-00	3
24	Arandela empuje	—	664-45576-00-00	1	66	Tubo extensión (Eje largo)	—	689-44362-00-94	1
25	Aro, Cojinete transportador	—	93210-30MA3-00	1	67	Aro, Tubo extensión	—	93210-26240-00	2
26	Cojinete, Reverso engranaje	—	93306-00612-00	1	68	Platina (Eje largo)	—	689-44328-03-00	1
27	Cojinete, transportador	—	689-45331-01-94	1	69	Ensamblaje (eje corto)	—	664-44150-01-00	1
28	Llave	—	90282-04010-00	1	69	Ensamblaje (eje largo)	—	664-44150-11-00	1
29	Cojinete, eje hélice	—	93315-22004-00	1	70	Boot	—	664-44147-00-00	1
30	Retén, eje hélice	18-0554	93101-20M07-00	2	71	Soporte	—	689-44176-01-00	1
31	Tapón arandela	—	90214-45M02-00	1	72	Tornillo, Soporte	—	97780-50610-00	1
32	Tuerca, Tapón	—	664-45384-00-00	1	73	Kit retenes de la caja de engr.	18-2785	689-W0001-22-00	1
33	Espaciador (ant)	—	664-45987-01-00	1	74	Kit bomba agua reparación	18-3427	689-W0078-A6-00	1
34	Espaciador (post)	—	689-45997-00-00	1					
35	Arandela, montaje hélice	—	92990-14200-00	1					
36	Tuerca, hélice	—	90171-14013-00	1					

AR Se requiere



25 — Gear Housing Seal Kit 18-2792

14 — Water Pump Repair Kit 18-3429

Fig. #	Descripción	Ref #	O.E.M. #	Cant.	Fig. #	Descripción	Ref #	O.E.M. #	Cant.
1	Tornillo, bomba agua alojamiento	—	97395-08055-00	2	39	Cojinete bola	—	93306-00702-00	1
2	Arandela, bomba agua aloj.	—	92990-08600-00	4	40	Tapón, Drenaje	18-2374	688-45341-00-00	1
3	Alojamiento, Bomba agua	—	663-44311-02-00	1	41	Hélice	—	various	1
4	Insert, Bomba agua	18-3435	663-44322-00-00	1	42	Tornillo, Trim Tab	—	97575-08675-00	1
5	Impulsor	18-3068	6H4-44352-02-00	1	43	Cola inf	—	6H4-45301-01-EK	1
6	Junta, bomba agua platina	18-0292	663-44315-A0-00	1	44	Arandela, cierre	—	92990=08100-00	1
					45	Tornillo inf	—	97095-08085-00	1
7	Placa de desgaste, Bomba agua	18-3436	663-44323-00-00	1	46	Tapón Trim	18-6096A	664-45371-01-00	1
8	Junta, bomba agua platina	18-0294	663-44324-A0-00	1	47	Retén	—	688-45375-00-00	1
					48	Retén goma	—	663-45376-00-94	1
9	Base, bomba agua	—	663-44341-00-94	1	49	Tornillo	—	98780-05535-00	1
10	Junta, bomba Base	—	663-44316-A0-00	1	50	Tapón, entrada de agua (babor)	—	668-45214,02-00	1
11	Aro, bomba base	18-0298	93210-41042-00	1	51	Arandela engranaje (0.5mm)	—	6H4-45567-00-05	1
12	Retén aceite, base bomba	18-0297	93101-23070-00	2		Arandela engranaje (0.8mm)	—	6H4-45567-00-08	AR
13	Tornillo, Bomba agua alojamiento	18-0256	97095-08045-00	2		Arandela engranaje (0.12mm)	—	6H4-45567-01-12	AR
14	Kit reparación bomba agua	18-3429	6H4-W0078-00-00	1		Arandela engranaje (0.30mm)	—	6H4-45567-01-30	AR
15	Retén agua	—	663-44366-00-00	1		Arandela engranaje (0.50mm)	—	6H4-45567-01-50	AR
16	Cojinete, rodillo cónico	—	93332-00079-00	1	52	Engranajes, rodillo cónico	—	93332-000V4-00	1
17	Eje transmisión (Corto)	—	6H4-45501-00-00	1	53	Engranajes	—	6H4-45560-00-00	1
17	Eje transmisión (Largo)	—	6H4-45501-10-01	1	54	Pasador	—	90250-06023-00	1
18	Arandela (0.5mm)	—	663-45587-00-05	AR	55	Embrague, Sliding	—	663-45631-01-00	1
	Arandela (0.8mm)	—	663-45587-00-08	AR	56	Aro retenedor, Pasador	—	663-45633-00-00	1
	Arandela (0.12mm)	—	663-45587-01-12	AR	57	Embolo	—	676-45635-00-00	1
	Arandela (0.30mm)	—	663-45587-01-30	AR	58	Fijador	—	663-45634-00-00	1
	Arandela (0.50mm)	—	663-45587-01-50	AR	59	Muelle, Compresión	—	60501-16M01-00	1
19	Casquillo, Eje transmisión	—	6H4-45536-00-0	1	60	Eje	—	679-45611-01-00	1
20	Cojinete de aguja	—	93315-32224-00	1	61	Arandela, Platina	—	90201-22429-00	1
21	Cojinete (no usado 1988 & después)	—	663-45552-00-00	1	62	Engranajes, Reverso	—	6H4-45571-00-00	1
22	Engranaje, Piñon	—	6H4-45551-00-00	1	63	Arandela engranaje reverso (0.5mm)	—	663-45577-00-05	AR
23	Tuerca, Piñon engranaje	—	90170-12138-00	1		Arandela engranaje reverso (0.8mm)	—	663-45577-00-08	AR
24	Llave, Woodruff	18-3305	90280-03024-00	1		Arandela engranaje reverso (0.12mm)	—	663-45577-01-12	AR
25	Kit retén caja engranaje	18-2792	6H4-W0001-20-00	1		Arandela engranaje reverso (0.3mm)	—	663-45577-01-30	AR
26	Tornillo, Platina	—	97095-06016-00	1		Arandela engranaje reverso (0.5mm)	—	663-45577-01-50	AR
27	Arandela, Platina	—	92990-06600-00	1	64	Arandela empuje	—	663-45576-00-00	1
28	Platina	—	6H4-45321-01-00	1	65	Pasador	18-2380	91490-30030-00	1
29	Aro, Platina	—	93210-49046-00	1	66	Tuerca	18-3732	90171-16011-11	1
30	Ensamblaje (eje corto)	—	6H4-44150-01-00	1	67	Arandela	—	92990-16200-00	1
	Ensamblaje (eje largo)	—	6H4-44150-12-01	1	68	Espaciador, Montaje hélice (ant)	—	670-45997-02-00	1
31	Aro, Cojinete alojamiento	18-0299	93210-66M98-00	1	69	Espaciador, Montaje hélice (post)	—	663-45987-02-00	1
32	Tapón, Vent.	—	90340-08M04-00	2	70	Tuerca, Tapón	—	697-45385-00-00	1
33	Pasador	—	93604-08062-00	2	71	Arandela, Tapón	—	90214-48M03-00	1
34	Junta, Tapón drenaje	—	90430-08020-00	3	72	Retén aceite, Cojinete alojamiento	18-0296	93101-22067-00	2
35	Tuerca, Nylock	—	90185-05904-00	1	73	Cojinete aguja	—	93317-22204-00	1
36	Tapón, Entrada de agua (estr)	—	688-45215-02-00	1	74	Llave, cojinete alojamiento	—	90282-04010-00	1
37	Arandela, Cierre	—	92990-10100-00	4	75	Alojamiento, Cojinete	—	679-45331-00-94	1
38	Tornillo	—	97078-10040-00	4					

AR Se requiere

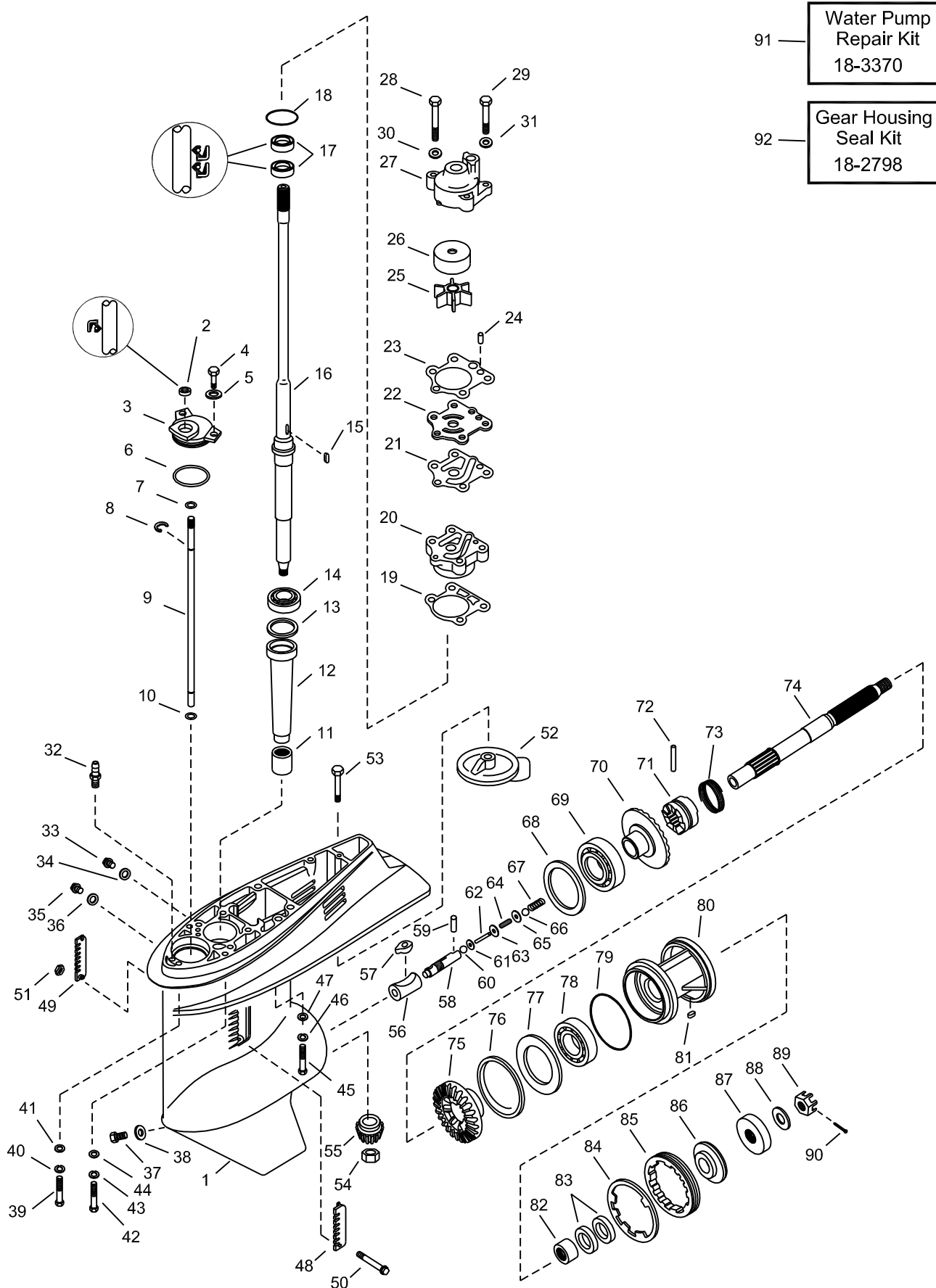

91 — Water Pump Repair Kit 18-3370

92 — Gear Housing Seal Kit 18-2798

Fig. #	Descripción	Ref #	O.E.M. #	Cant.	Fig. #	Descripción	Ref #	O.E.M. #	Cant.
1	Caja engranajes	—	6H1-45301-04-EK	1	50	Tornillo, entrada de agua	—	98680-05545-00	1
2	Retén aceite, Eje cambio	18-0267	93106-09014-00	1	51	Tuerca, Entrada de agua	—	90185-05002-00	1
3	Platina, Varilla de cambio	—	688-45321-00-00	1	52	Trim Tab	18-6070	988-45371-02-00	1
4	Tornillo, Ret. de varilla de camb.	—	97395-06016-00	2	53	Tornillo, Anodo montaje	—	90105-10M00-00	1
5	Arandela	—	92990-06600-00	2	54	Tuerca, Piñon	—	90170-16M01-00	1
6	Aro	—	93210-49046-00	1	55	Engranajes, Piñon	—	688-45551-01-00	1
7	Aro	—	93210-07540-01	1	56	Casquillo	—	6H1-45641-01-00	1
8	Anillo de retención	—	99001-08600-00	1	57	Casquillo	—	6H1-44151-00-00	1
9	Varilla	—	6H1-44144-00-00	1	58	Casquillo	—	6H1-45634-02-00	1
10	Clip	—	93450-07M00-00	1	59	Pasador	—	93603-12M11-00	1
11	Cojinete, Piñon	—	93315-325V1-00	1	60	Tuerca, Muelle	—	90183-02M03-00	1
12	Casquillo, Eje transmisión	—	688-45536-01-00	1	61	Arandela	—	6H1-45635-00-00	1
13	Arandela (0.10mm)	—	688-45587-01-10	AR	62	Eje	—	6H1-45668-00-00	1
	Arandela (0.12mm)	—	688-45587-01-12	AR	63	Arandela	—	6H1-45635-00-00	1
	Arandela (0.15mm)	—	688-45587-01-15	AR	64	Muelle, Compresión	—	90501-12M48-00	1
	Arandela (0.18mm)	—	688-45587-01-30	AR	65	Arandela platina	—	90201-03313-00	1
	Arandela (0.30mm)	—	688-45587-01-40	AR	66	Tuerca, Muelle	—	90183-02M03-00	1
	Arandela (0.40mm)	—	688-45587-01-50	AR	67	Muelle, Compresión	—	90501-16M65-00	1
	Arandela (0.50mm)	—	688-45587-01-16	AR	68	Arandela engranaje (0.10mm)	—	688-45567-01-10	AR
14	Cojinete, Eje transmisión sup.	—	93332-000U3-00	1		Arandela engranaje (0.12mm)	—	688-45567-01-12	AR
15	Llave, Impulsor	18-3301	90280-04M04-00	1		Arandela engranaje (0.15mm)	—	688-45567-01-15	AR
16	Eje transmisión	—	6H1-45501-11-00	1		Arandela engranaje (0.18mm)	—	688-45567-01-18	AR
17	Retén aceite, bomba base	18-0587	93101-25M03-00	2		Arandela engranaje (0.30mm)	—	688-45567-01-30	AR
18	Aro, Base	18-7436	9321-46044-00	1		Arandela engranaje (0.40mm)	—	688-45567-01-40	AR
19	Junta, Base	18-0240	688-44316-A0-00	1		Arandela engranaje (0.50mm)	—	688-45567-01-50	AR
20	Base, bomba agua	—	688-44341-01-94	1	69	Cojinete	—	93332-000W7-00	1
21	Junta, placa de desgaste a base	—	688-44324-A0-00	1	70	Engranajes	—	688-45560-00-00	1
22	Placa desgaste	18-3341	688-44323-00-00	1	71	Tuerca	—	6H1-45631-01-00	1
23	Junta, placa desgaste alojamiento	18-0239	688-44315-A0-00	1	72	Pasador	—	90250-07M02-00	1
24	Pasador	—	93604-10M03-00	1	73	Muelle, Pasador	—	688-45633-00-00	1
25	Impulsor	18-3070	688-44352-03-00	1	74	Eje, hélice	—	6H1-45611-01-00	1
26	Bomba agua	—	688-44322-00-00	1	75	Engranaje, Reverso	—	6H1-45571-00-00	1
27	Bomba agua alojamiento	18-3171	688-44311-01-00	1	76	Arandela eng. reverso (0.10mm)	—	688-45577-01-10	AR
28	Tornillo, bomba agua	—	97395-08070-00	2		Arandela eng. reverso (0.12mm)	—	688-45577-01-12	AR
29	Tornillo, bomba agua	—	97395-08050-00	2		Arandela eng. reverso (0.15mm)	—	688-45577-01-15	AR
30 &						Arandela eng. reverso (0.18mm)	—	688-45577-01-18	AR
31	Arandela, Bomba agua	—	90209-08M02-00	4		Arandela eng. reverso (0.30mm)	—	688-45577-01-30	AR
32	Conector manguera	—	6E5-45378-00-00	1		Arandela eng. reverso (0.40mm)	—	688-45577-01-40	AR
33	Tapón, Drenaje	18-2371	90340-08M04-00	1		Arandela eng. reverso (0.50mm)	—	688-45577-01-50	AR
34	Junta, Vent. & Tapones drenaje	18-46981-9	90430-08020-00	1	77	Arandela empuje	—	688-45576-00-00	1
35	Tapón, Drenaje	18-2371	90340-08M04-00	1	78	Cojinete, engranaje reverso	—	93306-207U0-00	1
36	Junta, Vent. & tapones drenaje	18-46981-9	90430-08020-00	1	79	Aro, Cojinete alojamiento	—	93210-85M97-00	1
37	Tapón, Drenaje	18-2374	688-45341-00-00	1	80	Cojinete alojamiento	18-2782	688-45331-00-94	1
38	Junta, Vent & tapones drenaje	18-46981-9	90430-08020-00	1	81	Llave	—	90282-04010-00	1
39	Tornillo	—	97395-10040-00	2	82	Cojinete aguja	—	93317-325U0-00	1
40	Arandela, Cierre	—	92990-10100-00	2	83	Retén aceite	18-0587	93101-25M03-00	2
41	Arandela	—	92990-10600-00	2	84	Arandela, Tapón	—	688-45383-02-00	1
42	Tornillo	—	97395-10040-00	2	85	Tuerca, Tapón	—	688-45384-00-00	1
43	Arandela, Cierre	—	92990-10100-00	2	86	Espaciador	—	688-45987-01-00	1
44	Arandela, Cierre	—	92990-10600-00	2	87	Espaciador	18-4274	688-45997-01-00	1
45	Bolt	—	97395-08060-00	1	88	Arandela hélice	—	90201-17M00-00	1
46	Arandela, Lock	—	92990-08100-00	1	89	Tuerca	18-3732	90171-16011-00	1
47	Arandela, Lock	—	92990-08100-00	1	90	Pasador	18-3735	91490-40030-00	1
48	Tapones, Entrada de agua (babor)	—	688-45214-02-00		91	Kit reparación bomba agua	18-3370	692-W0078-00-00	1
49	Tapón, entrada de agua (estr)	—	688-45215-02-00	1	92	kit retén engranajes alojamiento	18-2798	688-W0001-20-00	1

AR Se requiere

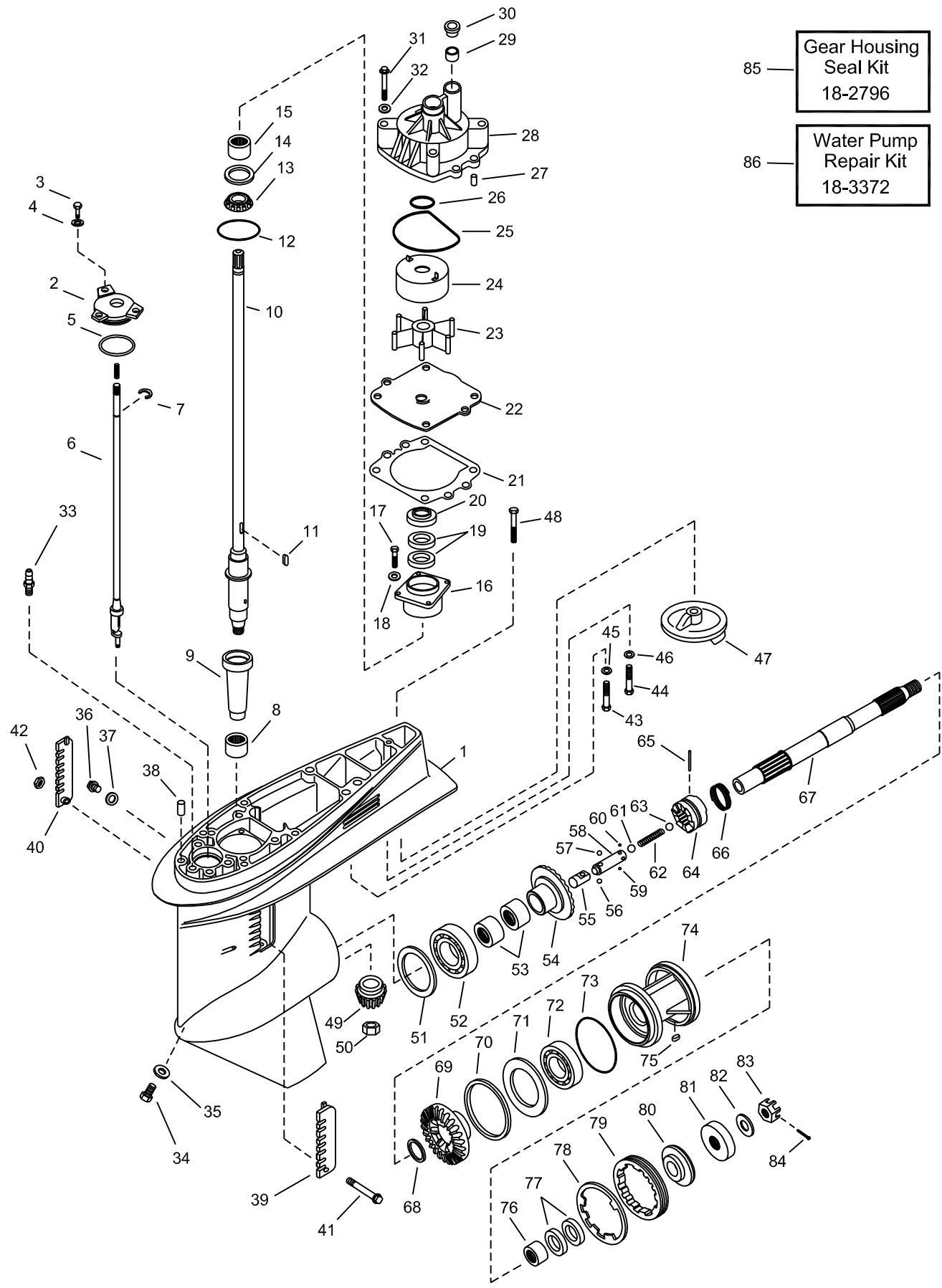

85 — Gear Housing Seal Kit
18-2796

86 — Water Pump Repair Kit
18-3372

Fig. #	Descripción	Ref #	O.E.M. #	Cant.	Fig. #	Descripción	Ref #	O.E.M. #	Cant.
1	Caja engranajes alojamiento	—	6E5-45301-03Ek	1	47	Tapón	18-6097A	6E5-45371-01-00	1
2	Platina	—	6E5-45321-00-00	1	48	Tornillo, Trim Tab	—	90105-10M00-00	1
3	Tornillo	—	97395-06020-00	3	49	Engranaje piñon	—	6E5-45551-02-00	1
4	Arandela	—	90209-06M04-00	3	50	Tuerca piñon	—	90170-16M01-00	1
5	Aro, Platina	—	93210-5867-00	1	51	Arandela (0.10mm)	—	6E5-45567-01-10	AR
6	Varilla	—	6E5-44150-01-00	1		Arandela (0.12mm)	—	6E5-45567-01-12	AR
7	Anillo de retención	—	99001-08600-00	1		Arandela (0.15mm)	—	6E5-45567-01-15	AR
8	Cojinete aguja	—	93315-628U9-00	1		Arandela (0.18mm)	—	6E5-45567-01-18	AR
9	Casquillo, eje transmisión	—	6E5-45536-00-00	1		Arandela (0.30mm)	—	6E5-45567-01-30	AR
10	Eje transmisión (largo)	—	6E5-45501-01-00	1		Arandela (0.40mm)	—	6E5-45567-01-40	AR
	Eje transmisión (x-largo)	—	6E5-45501-21-00	1		Arandela (0.50mm)	—	6E5-45567-01-50	AR
11	Llave, Impulsor	—	90280-04M05-00	1	52	Cojinete	—	93332-00U07-00	1
12	Aro, Alojamiento	—	93210-54534-00	1	53	Cojinete aguja	—	93315-425U7-00	2
13	Cojinete cónico	—	93341-930U0-00	1	54	Engranajes	—	6E5-45560-01-00	1
14	Arandela (0.10mm)	—	6E5-45587-01-10	AR	55	Casquillo	—	6E5-45641-01-00	1
	Arandela (0.12mm)	—	6E5-45587-01-12	AR	56	Bola de retención	—	93507-32031-00	1
	Arandela (0.15mm)	—	6E5-45587-01-15	AR	57	Bola de retención	—	93507-32031-00	1
	Arandela (0.18mm)	—	6E5-45587-01-18	AR	58	Casquillo	—	6E5-45634-01-00	1
	Arandela (0.30mm)	—	6E5-45587-01-30	AR	59	Bola de retención	—	93503-16010-00	1
	Arandela (0.40mm)	—	6E5-45587-01-40	AR	60	Bola de retención	—	93503-16010-00	1
	Arandela (0.50mm)	—	6E5-45587-01-50	AR	61	Bola de retención	—	93511-32027-00	1
15	Cojinete aguja	—	93315-430V5-00	1	62	Muelle, Compresión	—	90501-16M37-00	1
16	Cojinete alojamiento	—	6E5-45331-0094	1	63	Bola de retención	—	93511-32027-00	1
17	Tornillo, cojinete alojamiento	—	97395-08025-00	4	64	Tuerca	—	6R5-45631-01-00	1
18	Arandela	—	92990-08600-00	4	65	Pasador	—	90250-08M07-00	1
19	Retén, eje transmisión	18-0265	93101-28M16-00	2	66	Retenedor, Pasador	—	6E5-45631-01-00	1
20	Tapón, Retén aceite	—	6E5-45344-00-00	1	67	Eje, Propeller	18-2385	6E5-45611-01-00	1
21	Junta, platina	18-0244	6E5-44315-A0-00	1	68	Arandela de empuje	—	90201-30M92-00	1
22	Placa desgaste	18-3344	6G5-44323-00-00	1	69	Engranajes, Reverso	—	6E5-45571-04-00	1
23	Impulsor	18-3071	6E5-44352-00-00	1	70	Arandela (0.10mm)	—	6L6-45577-00-10	AR
24	Insertar bomba agua	—	6E5-44322-00-00	1		Arandela (0.12mm)	—	6L6-45577-00-12	AR
25	Aro, bomba agua	18-7485	93210-86M38-00	1		Arandela (0.15mm)	—	6L6-45577-00-15	AR
26	Aro, bomba agua	18-7483	93210-37M67-00	1		Arandela (0.18mm)	—	6L6-45577-00-18	AR
27	Pasador, bomba agua alojamiento	—	93606-12019-00	2		Arandela (0.30mm)	—	6L6-45577-00-30	AR
28	Bomba agua alojamiento	18-3170	6E5-44311-00-00	1		Arandela (0.40mm)	—	6L6-45577-00-40	AR
29	Damper, Retén agua	—	6E5-44365-00-00	1		Arandela (0.50mm)	—	6L6-45577-00-50	AR
30	Tapa, bomba alojamiento	—	6E5-44312-00-0	1	71	Arandela empuje	—	6E5-45576-00-00	1
31	Tornillo, bomba agua	—	97080-08045-00	4	72	Cojinete, engranaje reverso	—	93306-208U0-00	1
32	Arandela	—	90209-08M02-00	4	73	Aro, cojinete alojamiento	—	93210-86M39-00	1
33	Conector, manguera	—	6E5-45378-00-00	1	74	Cojinete alojamiento	—	6E5-45332-00-94	1
34	Tapón inferior drenaje	18-2374	688-45341-00-00	1	75	Llave, Cojinete alojamiento	—	90282-04010-00	1
35	Junta, tapón drenaje	18-4698	90430-08020-00	1	76	Cojinete aguja	—	93315-430U8-00	1
36	Tapón drenaje superior	—	90340-08M04-00	1	77	Retén, eje hélice	18-0266	93101-30M17-00	2
37	Junta, tapón drenaje	18-4698	90430-08020-00	1	78	Arandela, Tapón	—	688-45383-02-00	1
38	Pasador	—	93608-12M05-00	2	79	Tuerca, tapón	—	688-45384-00-00	1
39	Tapón, Entrada de agua (babor)	—	688-45214-02-00	1	80	Arandela de empuje	—	6E5-45987-01-00	1
40	tapón entrada de agua (estr)	—	688-45215-02-00	1	81	Espaciador, hélice	18-4274	688-45997-01-00	1
41	Tornillo, entrada de agua	—	90142-05M03-00	1	82	Arandela, hélice	—	92990-18200-00	1
42	Tuerca entrada de agua	—	90185-05002-00	1	83	Tuerca, hélice	18-3726	90171-18M04-00	1
43	Tornillo	—	97395-10070-00	1	84	Pasador	18-3735	91490-40030-00	1
44	Tornillo	—	97395-10070-00	1	85	Kit retén engranajes alojamiento	18-2796	6E5-W0001-51-00	1
45	Arandela	—	92990-10100-00	1	86	Kit reparación bomba de agua	18-3372	6E5-W0078-00-00	1
46	Arandela	—	92990-10100-00	1					

AR Se requiere

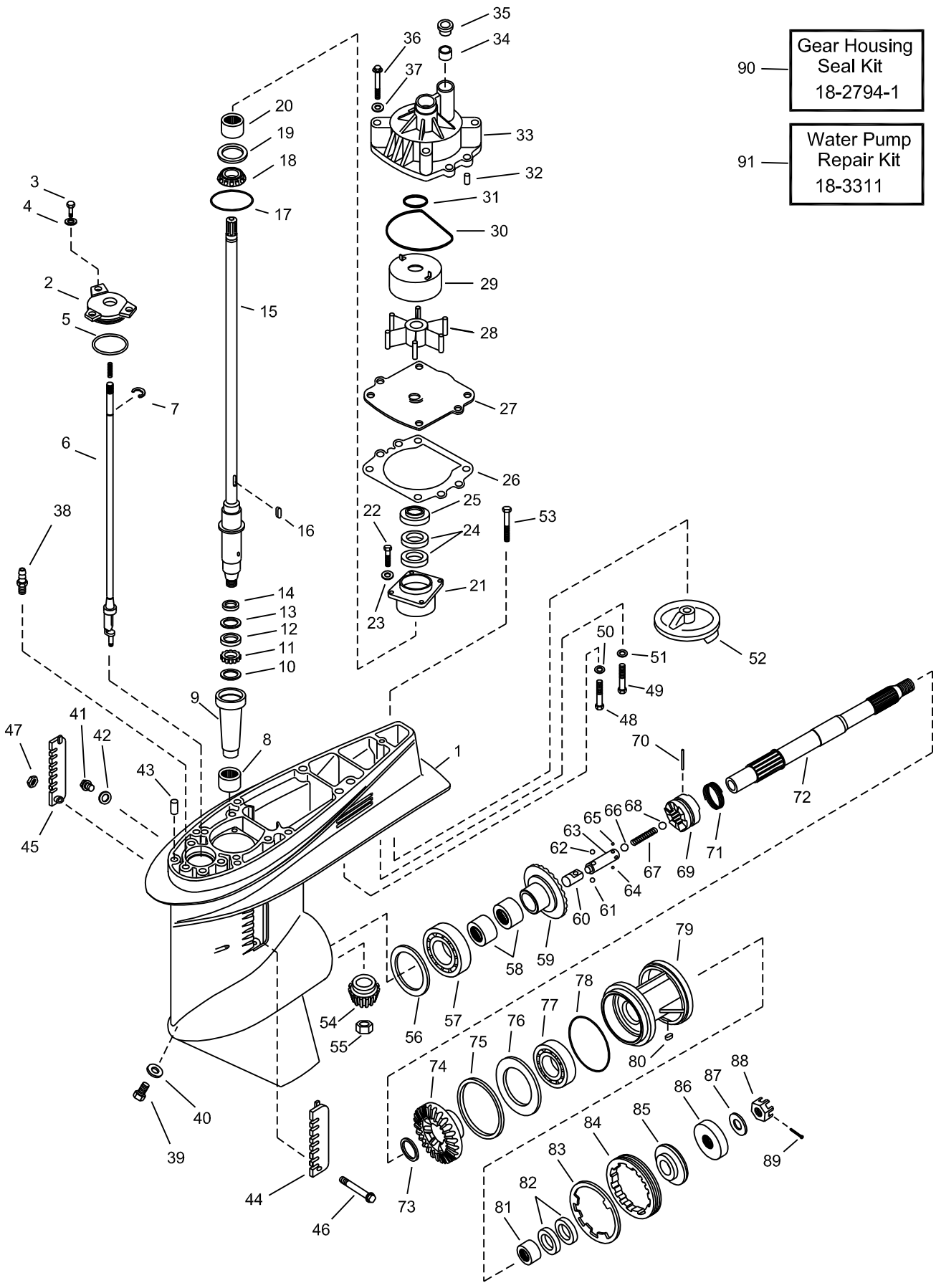

Gear Housing Seal Kit
18-2794-1

Water Pump Repair Kit
18-3311

Fig. #	Descripción	Ref #	O.E.M. #	Cant.	Fig. #	Descripción	Ref #	O.E.M. #	cant.
1	Alojamiento, Caja engranajes	—	6J9-45301-02-Ek	1	49	Tornillo	—	97395-10070-00	1
2	Platina	—	6E5-45321-00-00	1	50	Arandela	—	92990-10100-00	1
3	Tornillo	—	97395-06020-00	3	51	Arandela	—	92990-10100-00	1
4	Arandela	—	90209-06M04-00	3	52	Trim Tab	18-6035	6J9-45371-01-00	1
5	Aro, Platina	—	93210-58677-00	1	53	Tornillo, Trim Tab	—	90105-10M00-00	1
6	Varilla	—	6G5-44150-01-00	1	54	Piñon engranaje	—	6G5-45551-01-00	1
7	Anillo retención	—	99001-08600-00	1	55	Tuerca, Piñon	—	90170-16M01-00	1
8	Cojinete cónico	—	90250-08M07-00	1	56	Arandela (0.10mm)	—	6G5-45567-01-10	AR
9	Casquillo, eje transmisión	—	6G5-45536-01-00	1		Arandela (0.12mm)	—	6G5-45567-01-12	AR
10	Arandela	—	90209-33M13-00	1		Arandela (0.15mm)	—	6G5-45567-01-15	AR
11	Muelle, Compresión	—	90501-05M64-00	AR		Arandela (0.18mm)	—	6G5-45567-01-30	AR
12	Collar	—	90387-33M00-00	1		Arandela (0.30mm)	—	6G5-45567-01-40	AR
13	Arandela	—	90209-33M13-00	1		Arandela (0.40mm)	—	6G5-45567-01-50	AR
14	Arandela	—	90209-33M12-00	1		Arandela (0.50mm)	—	6G5-45567-01-10	AR
15	Eje transmisión (largo)	—	6G5-45501-01-00	1	57	Cojinete	—	93332-00V3-00	1
	Eje transmisión (x-largo)	—	6G5-45501-21-00	1	58	Cojinete aguja	—	93315-425V3-00	2
16	Llave, Impulsor	—	90280-04M05-00	1	59	Engranaje, Forward	—	6G5-45631-00-00	1
17	Aro, alojamiento	—	93210-54534-00	1	60	Casquillo	—	6E5-45641-01-00	1
18	Cojinete cónico	—	93341-930U0-00	1	61	Bola de retención	—	93507-32031-00	1
19	Arandela (0.10mm)	—	6E5-45587-01-10	AR	62	Bola de retención	—	93507-32031-00	1
	Arandela (0.12mm)	—	6E5-45587-01-12	AR	63	Casquillo	—	6E5-45634-01-00	1
	Arandela (0.15mm)	—	6E5-45587-01-15	AR	64	Bola de retención	—	93503-16010-00	1
	Arandela (0.18mm)	—	6E5-45587- 01-18	AR	65	Bola de retención	—	93503-16010-00	1
	Arandela (0.30mm)	—	6E5-45587-01-30	AR	66	Bola de retención	—	93511-32027-00	1
	Arandela (0.40mm)	—	6E5-45587-01-40	AR	67	Muelle, Compresión	—	90501-16M37-00	1
	Arandela (0.50mm)	—	6E5-45587-01-50	AR	68	Bola de retención	—	93511-32027-00	1
20	Cojinete aguja	—	93315-430V5-00	1	69	Tuerca	—	6E5-45633-01-00	1
21	Cojinete alojamiento	—	6E5-45331-00-94	1	70	Pasador, Clutch	—	90250-08M07-00	1
22	Tornillo, Cojinete alojamiento	—	97395-08025-00	4	71	Retenedor, Pasador	—	6E5-45633-01-00	1
23	Arandela	—	92990-08600-00	4	72	Eje hélice	—	6J9-45611-01-00	1
24	Retén, eje transmisión	18-0265	93101-28M16-00	2	73	Arandela empuje	—	90201-30M92-00	1
25	Tapón, retén aceite	—	6E5-45344-00-00	1	74	Engranaje, Reverso	—	6G5-45571-02-00	1
26	Junta, Platina	18-0244	6E5-44315-A0-00	1	75	Arandela (0.10mm)	—	6G5-45577-02-10	AR
27	Platina	18-3345	6G5-44323-00-00	1		Arandela (0.12mm)	—	6G5-45577-02-12	AR
28	Impulsor	18-3071	6E5-44352-00-00	1		Arandela (0.15mm)	—	6G5-45577-02-15	AR
29	Insertar bomba agua	—	6E5-44322-00-00	1		Arandela (0.18mm)	—	6G5-45577-02-18	AR
30	Aro, bomba agua	18-7485	93210-86M38-00	1		Arandela (0.30mm)	—	6G5-45577-02-30	AR
31	Aro, bomba agua	18-7483	93210-37M67-00	1		Arandela (0.40mm)	—	6G5-45577-02-40	AR
32	Pasador, bomba agua alojamiento	—	93606-12019-00	2		Arandela (0.50mm)	—	6G5-45577-02-50	AR
33	Bomba agua alojamiento	18-3170	6E5-44311-00-00	1	76	Arandela empuje	—	6G5-45576-00-00	1
34	Damper, Retén agua	—	6E5-44365-00-00	1	77	Cojinete, reverso engranaje	—	93306-209U0-00	1
35	Tapón, bomba alojamiento	—	6E5-44312-00-00	1	78	Aro, Cojinete alojamiento	18-0275	93210-97M55-00	1
36	Tornillo, Bomba agua	—	97080-08045-00	4	79	Cojinete	—	6J9-45332-00-94	1
37	Arandela	—	90209-08M02-00	4	80	Llave, cojinete alojamiento	—	90282-04010-00	1
38	Conector	—	6E5-45378-00-00	1	81	Cojinete aguja	—	93315-430U8-00	1
39	Tapón inferior drenaje	18-2374	688-45341-00-00	1	82	Retén, eje hélice	18-0266	93101-30M17-00	2
40	Junta, tapón drenaje	—	90430-08020-00	2	83	Arandela, tapón	—	9G5-45383-01-00	1
41	Tapón drenaje superior	—	90340-08M04-00	1	84	Tuerca, Tapón	—	6G5-45384-00-00	1
42	Junta, tapón drenaje	—	90430-08020-00	2	85	Arandela empuje	—	6E5-45987-00-00	1
43	Pasador	—	93608-12M05-00	2	86	Espaciador, hélice	18-4274	688-45997-01-00	1
44	Tapón, entrada de agua (Babor)	—	6J9-45214-00-00	1	87	Arandela hélice	—	92990-18200-00	1
45	Tapón, entrada de agua (Estr)	—	6J9-45215-00-00	1	88	Tuerca hélice	18-3726	90171-18M04-00	1
46	Tornillo, Entrada de agua	—	90142-05M04-00	1	89	Pasador	18-3735	91490-40030-00	1
47	Tuerca, Entrada de agua	—	90185-05002-00	1	90	Kit retén engranajes alojamiento	18-2794-1	6G5-W0001-21-00	1
48	Tornillo	—	97395-10070-00	1	91	Kit reparación bomba agua	18-3311	6G5-W0078-00-00	1

AR Se requiere

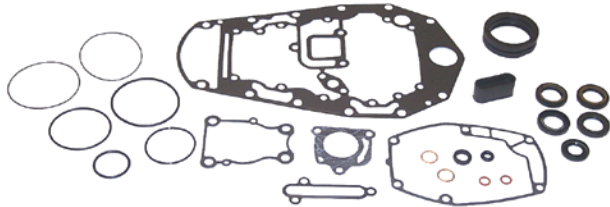

18-0020
KIT RETENES ALOJAMIENTO ENGRANAJES
 Reemplaza: 67C-W0001-21-00
 Para: T25 (2001-02) / F30 (2002) F40 (2002) 3 cil modelo

— CONTIENE —

Ref #	Desc.	O.E.#	Cant.
18-0296	Retén, eje hélice	93101-22067	2
18-4698	Arandela drenaje	90430-08020-00	2
18-4698	Arandela drenaje	604-45342-00-00	2
18-4698	Arandela drenaje	90430-08020-00	2



18-0021
KIT RETÉN ALOJAMIENTO ENGRANAJE
 Reemplaza: 688-W0001-22-00

Para: C75 (1994-99) / E75 (1995-00) / P75 (1996-99)
 C80 (1997) / C85 (1992-96) / 90 (1992-02) B90(1998-99) / C90 (1997-01)

— CONTIENE —

Ref #	Desc.	O.E.#	Cant.
18-0239	Junta	688-44315-A0	1
18-0240	Junta	688-44316-A0	1
18-7436	Aro	93210-46044-00-00	2
18-0267	Retén aceite	93106-09014	1
18-0587	Retén aceite	93101-25M03	4
18-4698	Arandela drenaje	90430-08020	2



18-0022
KIT RETÉN ALOJAMIENTO ENGRANAJE
 Reemplaza: 689-W0001-23-00
 Para: C25 (1992-97) / C30 (1992)

— CONTIENE —

Ref #	Desc.	O.E.#	Cant.
18-99010	Junta colector escape	664-41134-A0-00	1
18-0296	Retén, eje hélice	93101-22067	2
18-0554	Retén	93101-20M07	2
18-0773	Junta	689-44316-A0	1
18-4698	Arandela, Drenaje	90430-08020	3



18-0023
KIT RETÉN ALOJAMIENTO ENGRANAJE
 Reemplaza: 689-W0001-C2-00

Para: C25 (1986-87) C25 (1990-91) 30 (1986) C30 (1990-91)

— CONTIENE —

Ref #	Desc.	O.E.#	Cant.
18-99010	Junta colector escape	664-41134-A0-00	1
18-0554	Retén	93101-20M07	2
18-4698	Arandela, Drenaje	90430-08020	3



18-0024
KIT RETÉN ALOJAMIENTO ENGRANAJE
 Reemplaza: 698-W0001-21-00
 Para: E48 (1995-00) / C55 (1989-94)

— CONTIENE —

Ref #	Desc.	O.E.#	Cant.
18-0292	Junta	663-44315-A0	1
18-0294	Junta	663-44324-A0	1
18-0297	Retén, eje transmisión	93101-23070	2
18-0296	Retén, eje hélice	93101-22067	2
18-0298	Aro	93210-41042	1
18-7160	Aro	93210-66M98	1
18-4698	Arandela, Drenaje	90430-08020	3

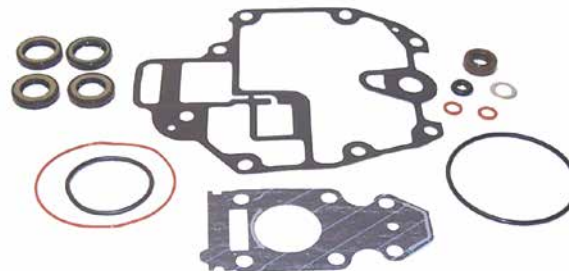

18-0025
KIT RETÉN ALOJAMIENTO ENGRANAJE
 Reemplaza: 69G-W0001-20-00

Para: T8 (2001-04)

— CONTIENE —

Ref #	Desc.	O.E.#	Cant.
18-7442	Aro	93210-74M68	1
18-4698	Arandela, Drenaje	90430-08020	2



18-0026
KIT RETÉN ALOJAMIENTO ENGRANAJE
 Reemplaza: 6A1-W0001-C2-00
 Para: 2HP (1986-88)

— CONTIENE —

Ref #	Desc.	O.E.#	Cant.
18-4698	Arandela, Drenaje	90430-08020	2



18-0027
KIT RETÉN ALOJAMIENTO ENGRANAJE
 Reemplaza: 6A1-W0001-23-00
 Para: 2HP (1989-02)

— CONTIENE —

Ref #	Desc.	O.E.#	Cant.
18-4698	Arandela, Drenaje	90430-08020	2



18-0028
KIT RETÉN ALOJAMIENTO ENGRANAJE
 Reemplaza: 6E0-W0001-C1-00
 Para: 4HP (1984-99) / F4 (1999-02) / 5HP (1984-02)

— CONTIENE —

Ref #	Desc.	O.E.#	Cant.
18-4698	Arandela, Drenaje	90430-08020	3



18-0029
KIT RETÉN ALOJAMIENTO ENGRANAJE
 Reemplaza: 6G1-W0001-C1-00
 Para: 6HP (1986-96) 8HP (1984-96)

— CONTIENE —

Ref #	Desc.	O.E.#	Cant.
18-4698	Arandela, Drenaje	90430-08020	3



18-0030
KIT RETÉN ALOJAMIENTO ENGRANAJE
 Reemplaza: 6L2-W0001-C3-00
 Para: 20HP (1996-97) 25HP (1988-02) 2 cil

— CONTIENE —

Ref #	Desc.	O.E.#	Cant.
18-0554	Retén	93101-20M07	2
18-4698	Arandela, Drenaje	90430-08020	2



18-0031
KIT RETÉN ALOJAMIENTO ENGRANAJE
 Reemplaza: 6N0-W0001-C0-00
 Para: 6HP (1997-00), 8HP (1997-04)

— CONTIENE —

Ref #	Desc.	O.E.#	Cant.
18-4698	Arandela, Drenaje	90430-08020	3

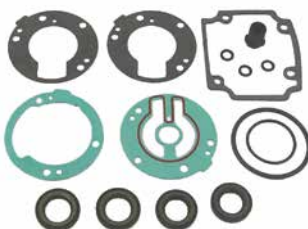

18-2785
KIT RETÉN ALOJAMIENTO ENGRANAJE
 Reemplaza: 689-W0001-21-00, 689-W0001-C1-00

— CONTIENE —

Ref #	Desc.	O.E.#	Cant.
18-0776	Casquillo	682-44365-00-00	1
18-0552	Casquillo	689-44366-00-00	1
18-4698	Junta drenaje/llenado	YSG-14090-90-8G	3
18-0554	Retén aceite	93101-20M07-00	1
18-0296	Retén aceite	93101-22067-00	2
18-7405	Aro	93210-40M10-00	1
18-0766	Junta tubo escape	664-41134-A0-00	1
18-0773	Junta platina desgaste	689-44316-A0-00	1

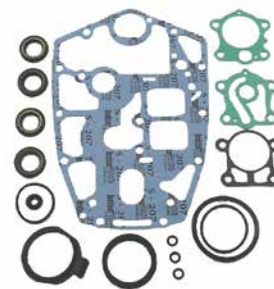

18-2787
KIT RETÉN ALOJAMIENTO ENGRANAJE
 Reemplaza: 698-W0001-20-00, 698-W0001-C0-00

— CONTIENE —

Ref #	Desc.	O.E.#	Cant.
18-4698	Arandela drenaje	YSG-14090-90-8G	3
18-0296	Retén aceite	93101-22067-00	2
18-0297	Retén aceite	93101-23070-00	2
18-0298	Aro	93210-41042-00	1
18-0299	Aro	93210-66M98-00	1
18-0292	Junta platina a alojamiento bomba	663-44315-A0-00	1
18-0267	Aro	93106-09014-00	1
18-0294	Junta platina a base bomba	663-44324-A0-00	1

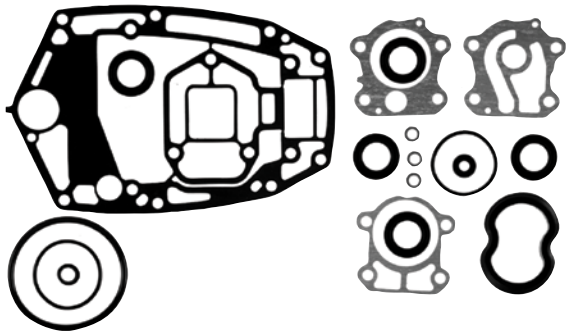

18-2788
KIT RETÉN UNIDAD INFERIOR
 Reemplaza: 6H3-W0001-21-00, 6H3-W0001-C1-00
 — CONTIENE —

Ref #	Desc.	O.E. #	Cant.
18-0240	Junta platina desgaste	688-44316-A0-00	1
18-0756	Junta bomba agua	6H3-44315-A0-00	1
18-0757	Junta platina	6H3-44324-A0-00	1
18-4698	Arandela llenado/drenaje	YSG-14090-90-8G	3
18-0297	Retén aceite	93101-23070-00	2
18-0267	Retén aceite	93106-09014-00	1
18-7436	Aro	93210-46044-00	1

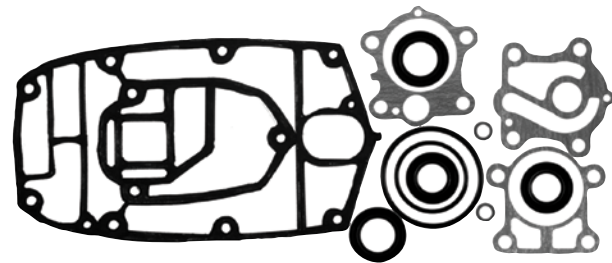

18-2789
KIT RETÉN UNIDAD INFERIOR
 Reemplaza: 6J8-W0001-21-00, 6J8-W0001-C2-00
 — CONTIENE —

Ref #	Desc.	O.E. #	Cant.
18-0292	Junta platina desgaste	663-44315-A0-00	1
18-0294	Junta platina desgaste	663-44324-A0-00	1
18-4698	Arandela drenaje/llenado	YSG-14090-90-8G	2
18-0554	Retén aceite	93101-20M07-00	2
18-0297	Retén aceite	93101-23070-00	2
18-0298	Aro	93210-41042-00	1

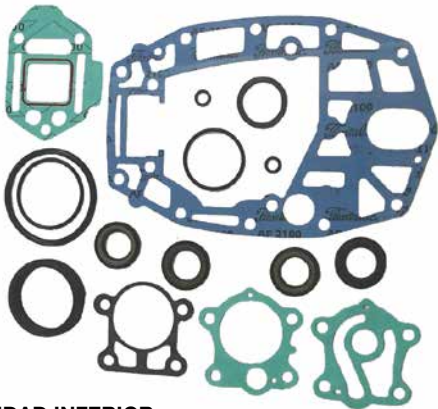

18-2792
KIT RETÉN UNIDAD INFERIOR
 Reemplaza: 6H4-W0001-21-00, 6H4-W0001-20-00
 — CONTIENE —

Ref #	Desc.	O.E. #	Cant.
18-0292	Junta platina desgaste	663-44315-A0-00	1
18-0294	Junta platina desgaste	663-44324-A0-00	1
18-4698	Junta drenaje / llenado	YSG-14090-90-8G	2
18-0296	Retén aceite	93101-22067-00	2
18-0297	Retén aceite	93101-23070-00	2
18-0298	Aro	93210-41042-00	1
18-0299	Aro	93210-66M98-00	1
18-0293	Junta base bomba	663-44316-A0-00	1

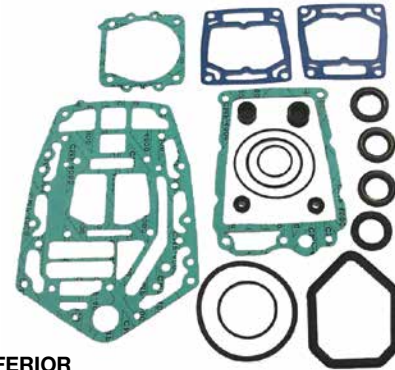

18-2794-1
KIT RETÉN UNIDAD INFERIOR
 Reemplaza: 6F3-W0001-21-00, 6F3-W0001-C1-00
 6E5-W0001-51-00, 6E5-W0001-F1-00
 6G5-W0001-21-00, 6G5-W0001-C1-00
 — CONTIENE —

Ref #	Desc.	O.E. #	Cant.
18-0244	Junta bomba agua	6E5-44315-A0-00	1
18-4698	Junta drenaje/llenado	YSG-14090-90-8G	2
18-0265	Retén aceite	93101-28M16-00	2
18-0266	Retén aceite	93101-30M17-00	2
18-0267	Retén aceite	93106-09014-00	1
18-7483	Aro	93210-37M67-00	1
18-7485	Aro	93210-86M38-00	1
18-0275	Aro	93210-97M55-00	1

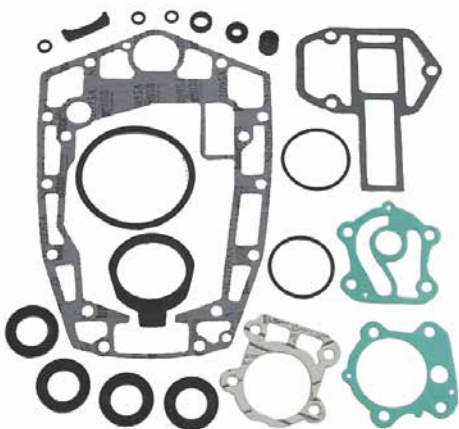

18-2798
KIT RETÉN INFERIOR
 Reemplaza: 688-W0001-20-00, 688-W0001-C0-00
 — CONTIENE —

Ref #	Desc.	O.E. #	Cant.
18-0240	Junta	688-44316-A0-00	1
18-4698	Junta drenaje llenado	YSG-14040-90-8G	3
18-7436	Aro	93210-46044-00	1
18-0239	Junta platina aloj. bomba	688-44315-A0-00	1
18-0267	Retén aceite	93106-09014-00	1

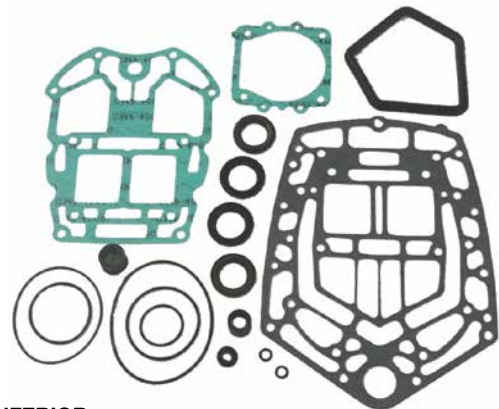

18-2799
KIT RETÉN INFERIOR
 Reemplaza: 61A-W0001-21-00, 61A-W0001-C1-00
 — CONTIENE —

Ref #	Desc.	O.E. #	Cant.
18-0244	Junta bomba agua	6E5-44315-A0-00	1
18-4698	Junta drenaje/llenado	YSG-14040-90-8G	2
18-0265	Retén aceite	93101-28M16-00	2
18-0266	Retén aceite	93101-30M17-00	1
18-0267	Retén aceite	93106-09014-00	1
18-7483	Aro	93210-37M67-00	1
18-7485	Aro	93210-86M38-00	1
18-7444	Aro	93210-04384-00	1



18-74501
KIT RETÉN ALOJ. ENGR.
 Reemplaza: 683-W0001-C1-00
 Para: Yamaha 9.9/15(1984-91)



18-74504
KIT RETÉN ALOJ. ENGRANAJE
 Reemplaza: 6H3-W0001-22-00
 Para: Yamaha 60(2002), C60(1996-01),
 E60(1995-00), P60(1992-99), 70(1992-02)



18-74507
KIT RETÉN ALOJ. ENGRANAJE
 Reemplaza: 63V-W0001-21-00
 Para: Yamaha 9.9(1997-00), 15(1997-00)



18-74510
KIT RETÉN ALOJ. ENGRANAJE
 Reemplaza: 65L-W0001-C0-00
 Para: Yamaha 225/L225(1997-99), 3.1L,
 250/L250(1997-99), SX225/SX250(2000-02),
 LX225/LX250(2000-02)



18-74512
KIT RETÉN ALOJ. ENGRANAJE
 Reemplaza: 66K-W0001-20-00
 Para: Yamaha V200/V225(1998-99), VX200/
 VX225(2000-02), VX250(2002)



18-74515
KIT RETÉN ALOJ. ENGRANAJE
 Reemplaza: 68V-W0001-20-00
 Para: Yamaha F115/LF115(2000-05)



18-74527
KIT RETÉN ALOJ. ENGRANAJE
 Reemplaza: 6G9-W0001-C6-00
 Para: Yamaha F9.9(1997-05)



18-74535
KIT RETÉN ALOJAMIENTO ENGRANAJE
 Reemplaza: 67F-W0001-20-00
 Para: Yamaha F75/F90(2003-05), F80/F100(1999-02)



18-74540
KIT RETÉN
 Reemplaza: 62Y-W0001-20-00
 Para: Yamaha F40 4cil(1999), F50(1995-00)



18-74544
KIT RETÉN ALOJ. ENGRANAJE
 Reemplaza: 68T-W0001-20-00
 Para: Yamaha F6/F8(2001-03)



18-74546
KIT RETÉN ALOJAMIENTO ENGRANAJE
 Para: Yamaha T40/T30 Enduro International Series

APLICACIÓN KIT RETÉN ALOJAMIENTO ENGRANAJES

Modelo #	Año	kit juntas unidad inf.	Modelo #	Año	Kit juntas unidad inf.	Modelo #	Año	kit juntas unidad inf.
2	1986-88	18-0026	C55	1992-95	18-0024	SX150	1999-04	18-2794-1
2	1989-02	18-0027	CV55	1989-90	18-2787	V150	2000-08	18-2794-1
4	1984-99	18-0028	P60	1991	18-2788	VX150	2000-04	18-2794-1
F4	1999-08	18-0028	70	1984-85, 1988-91	18-2788	VZ150	2000-11	18-2794-1
5	1984-02	18-0028	C75	1994-99	18-0021	175	1984-00	18-2794-1
6	1988-96	18-0029	E75	1995-00	18-0021	P175	1994-99	18-2794-1
6	1997-00	18-0031	P75	1996-99	18-0021	S175	1996-99	18-2794-1
8	1984-96	18-0029	C80	1997	18-0021	V175	2000	18-2794-1
8	1997-09	18-0031	C85	1991	18-2798	VZ175	2001-11	18-2794-1
T8	2001-10	18-0025	C85	1992-96	18-0021	Z175	2001-05	18-2794-1
20	1996-97	18-0030	CV85	1989-90	18-2798	200	1984-98	18-2794-1
25 ①	1984-85	18-2785	90	1984-91	18-2798	L200	1986-99	18-2794-1
25 ①	1986-87	18-0023	90	1992-09	18-0021	LX200	1999-01	18-2794-1
25 ①	1988-09	18-0030	B90	1997-99	18-0021	LZ200	2000-11	18-2794-1
25 ②	1997-02	18-2789	C90	1997-	18-0021	P200	1991-99	18-2794-1
C25	1991	18-0023	115	1986-09	18-2794-1	S200	1996-99	18-2794-1
C25 ①	1992-97	18-0022	C115	1992-00	18-2794-1	SX200	1999-05	18-2794-1
CV25	1990	18-0023	P115	1993-96	18-2794-1	VZ200	2001-04	18-2794-1
T25 ①	2002	18-0020	S115	1996-99	18-2794-1	Z200	2000-11	18-2794-1
30	1984-85	18-2785	130	1988-04	18-2794-1	V6 Especial	1984-86	18-2794-1
30	1986	18-0023	L130	1989-01	18-2794-1	V6 Excel	1987-89	18-2794-1
30	1987-02	18-2789	S130	1996-99	18-2794-1	225 ③	1990-97	18-2794-1
C30	1991	18-0023	150	1984-09	18-2794-1	225 ④	1994-96	18-2799
C30	1992	18-0022	C150	1996-99	18-2794-1	L225 ④	1994-96	18-2799
F30 ②	2002	18-0020	L150	1986-99	18-2794-1	S225	1996	18-2799
40	1984-94	18-2792	LX150	1999-01	18-2794-1	250	1990-95	18-2799
C40	1992-94	18-99104	LZ150	2000-05	18-2794-1	L250	1990-96	18-2799
F40 ②	2002	18-0020	Z150	2000-05	18-2794-1	S250	1996	18-2799
50	1986-94	18-2792	P150	1991-99	18-2794-1			
PRO 50	1987-90	18-2792	PX150 1999		18-2794-1			
P50	1992-94	18-2792	PRO V150	1987-90	18-2794-1			
C55	1991	18-2787	S150	1996-99	18-2794-1			

① 2 cilindro modelo ② 3 cilindro modelo ③ 2.6 litros ④ 3.1 litros

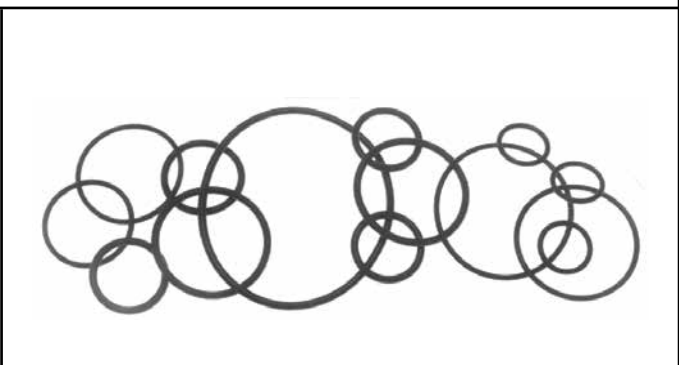





RETÉN ACEITE

Ref #	O.E.#	Dimensiones			AROS					
		D.I.	D.E.	Ancho	Ref #	Est. Pkg.	O.E.#	Ref #	Est. Pkg.	O.E.#
18-0265	93101-28M16-00	27	43.25	7	18-0275	1	93210-97M55-00	18-7469	1	64E-43869-00-00
18-0266	93101-30M17-00	28.5	45.25	7	18-0298	1	93210-41042-00	18-7470	1	65W-43865-00-00
18-0267	93106-09014-00	8.75	19.2	5.25	18-0299	1	93210-66M98-00	18-7483	1	93210-37M67-00
18-0296	93101-22067-00	23	36.25	6	18-7119	1	93210-33M85-00	18-7485	1	93210-86M38-00
18-0297	93101-23070-00	22.75	37.25	6	18-7432 ⑤	2	93210-32738-00	18-76689	1	65W-14198-00-00
18-0554	93101-20M07-00	21.5	34	6.25	18-7436	1	93210-46044-00	18-76690	1	93210-46M16-00
18-0570	93102-23096-00	22.75	38.25	7	18-7442	1	93210-74M35-00	18-76691	1	93210-27ME3-00
18-0587	93101-25M03-00	24	40.25	6	18-7444	1	93211-04384-00	18-76692	1	93210-75M51-00
18-2079	93101-22M15-00	21.75	35.2	6	18-7463	1	93210-19123-00	18-76693	1	93210-31MJ5-00
18-2085	93102-35M13-00	34	52.25	8	18-7468	1	6G5-43864-00-00	18-76694	1	93210-24M79

⑤ Precio por pieza. Pedir precio por pack, añadir -9 a la referencia.

POTENCIA HP	AÑO	Ref. CHAMPION	Ref. PRONAUTIC	POTENCIA HP	AÑO	Ref. CHAMPION	Ref. PRONAUTIC
2	1984+	L90C	051028	30F	2001+	RA8HC	050957
3	1988+	QL86C/L86C	050919/050910	40F	1999+	RA8HS	051015
5	1984+	QL82C/L82C	050966/050937	50F	1999+	RA8HC	050957
6	1986+	QL82C/L82C	050966/050937	60	2002+	RA8HC	050957
8	1984+	QL82C/L82C	050966/050937	75	2003+	10YC4	050984
9,9	1984+	QL82C/L82C	050966/050937	80	1999+	10YC4	050984
20	1996+	QL82C/L82C	050966/050937	90B	1984+	QL78C/L78C	050915/050907
25	1999+	QL82C/L82C	050966/050937				
30	1984+	QL82C/L82C	050966/050937				
40	1984+	QL82C/L82C	050966/050937				
50	1995+	RA8HC	050957				
70	1984+	QL78C/L78C	050915/050907				
90	1984-2000	QL78C/L78C	050915/050907				
115	1984-2005	QL78C/L78C	050915/050907				
130	1989+	QL78C/L78C	050915/050907				
150 Carb	1996+	QL82C/L82C	050966/050937				
150EFI	1999-2000	QL78C/L78C	050915/050907				
150EFI	2000+	RC12YC	051012				
150MPDI	2000+	RC12YC	051012				
150VMAX	1997+	QL78C/L78C	050915/050907				
175	1984+	QL78C/L78C	050915/050907				
175VMAX	1992+	QL78C/L78C	050915/050907				
200LX	1999+	QL78C/L78C	050915/050907				
200LZ	1999+	RC9YC4	051013				
200SX	1999+	QL78C/L78C	050915/050907				
200VX	2000+	QL78C/L78C	050915/050907				
200Z	2000+	RC9YC4	051013				
225	2000+	QL77JC4/ L77JC4	050914/050906				
250	2000+	QL77JC4/ L77JC4	050914/050906				
4 TIEMPOS							
2.5F	2003+	QL86C/L86C	050919/050910				
4F	1999+	QL86C/L86C	050919/050910				
9.9Fi	1996+	Z9Y	051014				
9.9T	1996+	Z9Y	051014				
15F	1999+	RA8HS	051015				
25F	1998+	RA8HS	051015				

 				 			
POTENCIA HP	AÑO	Ref. CHAMPION	Ref. PRONAUTIC	POTENCIA HP	AÑO	Ref. CHAMPION	Ref. PRONAUTIC
2A		B6HS	050804	20C(C20)	99-	B7HS	050806
2B	87-	BR5HS	050892	20C/CE/CM		BR7HS-10	050832
2B	85-86	B7HS	050806	20D		BR7HS-10	050832
2B	-84	BR5HS	050892	25A		B7HS	050806
2C	95-	B7HS	050806	25B	-94	B7HS	050806
3.5A/AC		B6HS	050804	25B	01-	BR7HS-10	050832
3A (Malta)		BR6HS-10	050880	25B/25Q	95-00	BR7HS-10	050832
4A/AC/AS/BC		BR7HS	050853	25CMK		B6HS	050804
4A/B	01-	B7HS	050806	25D (25)		B7HS	050806
5A/AS		B7HS	050806	25DE		BR7HS-10	050832
5B/BS		B6HS	050804	25J		BR7HS-10	050832
5C		BR7HS	050853	25N		BR7HS-10	050832
5D		B5HS	050802	25V (25)	95-	BR7HS-10	050832
6A		B6HS	050804	28A/AE		B7HS	050806
6B		B5HS	050802	30A/AE/AM		B7HS	050806
6C		BR7HS-10	050832	30D		BR7HS-10	050832
6D		BR6HS-10	050880	30G	95-	B8HS-10	050810
7A		B6HS	050804	30H	01-	B8HS-10	050810
8A		B6HS	050804	40AE/AM/AR		B8HS	050809
8B		B7HS	050806	40BE/BM/BR		B8HS	050809
8C		BR7HS-10	050832	40C		B8HS	050809
9.5A		B7HS	050806	40D	-89	B8HS	050809
9.9B		B7HS	050806	40F		B8HS	050809
9.9D		BR7HS-10	050832	40FE		B7HS-10	050807
9.9F	95-	BR7HS-10	050832	40GK		B7HS	050806
9A		B6HS	050804	40H		BR7HS-10	050832
12A		B7HS	050806	40J	01-	B7HS	050806
13.5A		BR7HS-10	050832	40Q(40)	95-	BR8HS	050854
13.5F		B7HS-10	050807	40V	95-	BR7HS-10	050832
15A		B7HS	050806	40X	-00	BR7HS	050853
15B		B7HS	050806	40Y (ET)	01-	BR8HS-10	050835
15C		B7HS	050806	40Y (MH)	01-	BR7HS-10	050832
15D		BR7HS-10	050832	48A/B		B7HS	050806
15F	95-	BR7HS-10	050832	50	01-	B8HS-10	050810
20A		B6HS	050804	50C		B8HS	050809
20B		B6HS	050804	50CE		B8HS-10	050810

YAMAHA



YAMAHA



POTENCIA HP	AÑO	Ref. CHAMPION	Ref. PRONAUTIC	POTENCIA HP	AÑO	Ref. CHAMPION	Ref. PRONAUTIC
50D		BR8HS-10	050835	130BETO		BR9HS-10	050837
50G/50H	95-	BR8HS-10	050835	140A		BR8HS-10	050835
60TLRB	03-	B7HS-10	050807	140B	-88	BR8HS-10	050835
55AE	-78	B8HS	050809	140B	89-	BR9HS-10	050837
55AE	79-	B8HS-10	050810	140BETO		BR9HS-10	050837
55AEM/AM/AW		B8HS	050809	140C/L140C	95-	BR9HS-10	050837
55B		B8HS-10	050810	150A	86-	BR8HS-10	050835
55B	90-	BR8HS-10	050835	150A	-85	BR7HS-10	050832
55B(M)	95-	B8HS	050809	150AETO/C		BR8HS-10	050835
55BM/BW		B8HS	050809	150C		BR8HS-10	050835
60	01-	B8HS-10	050810	150F/L150F		BR7HS-10	050832
60AE	-78	B8HS	050809	150G		BR7HS-10	050832
60AE	79-	B8HS-10	050810	175A		BR8HS-10	050835
60B		B8HS-10	050810	175B		BR8HS-10	050835
60CE/CET		B8HS-10	050810	175D		BR8HS-10	050835
60D	86-	BR8HS-10	050835	175F		BR8HS-10	050835
60DE		B8HS-10	050810	200A		BR8HS-10	050835
60F		BR8HS-10	050835	200C		BR9HS-10	050837
70B		BR8HS-10	050835	200F(L200F)		BR8HS-10	050835
70C		BR8HS-10	050835	200G		BR8HS-10	050835
70ETO		BR8HS-10	050835	220A/AET	86-	BR8HS-10	050835
75A		BR8HS-10	050835	225AETO		BR8HS-10	050835
75B		BR8HS-10	050835	225AO/BETO/B/C		BR9HS-10	050837
75C		BR8HS-10	050835	225D		BR8HS-10	050835
80A		BR8HS-10	050835	225G		BR9HS-10	050837
85A		BR8HS-10	050835	250A/L250A		BR8HS-10	050835
90A		BR8HS-10	050835	250B/L250B		BR9HS-10	050837
100AETOL	98-	BR8HS-10	050835	50H	95-	BR8HS-10	050835
100A		BR8HS-10	050835	D150H		BR8HS-10	050835
115A	04-	B8HS-10	050810	E8D		BR7HS-10	050832
115AEO/AO		BR8HS-10	050835	E40X/40X		BR7HS	050853
115B/BETO		BR8HS-10	050835	E60H		BR8HS-10	050835
115C		BR8HS-10	050835	4 TIEMPOS			
115D	95-	BR8HS-10	050835	F2.5A	02-	BR6HS	050714
130A		BR9HS-10	050837	F4A	98-	BR6HS	050714
130B	95-	BR9HS-10	050837	F6A	00-	BR6HS-10	050880

YAMAHA



YAMAHA



POTENCIA HP	AÑO	Ref. CHAMPION	Ref. PRONAUTIC	POTENCIA HP	AÑO	Ref. CHAMPION	Ref. PRONAUTIC
F6B	01-	BR6HS-10	050880	L150/A/C/D	95-	BR8HS-10	050835
F8	01-	BR6HS-10	050880	L150AETO/CETO		BR8HS-10	050835
F8-A	85-	CR6HS	050845	L150F		BR7HS-10	050832
F8B/AM-AEM	86-02	CR5HS	050883	L200A/B	95-	BR8HS-10	050835
F8B/BM/BE	86-	CR5HS	050883	L200AETO/BETO		BR8HS-10	050835
F8C	00-	BR6HS-10	050880	L200F		BR8HS-10	050835
F9.9DE		BR7HS-10	050832				
F9.9A	85-00	CR6HS	050845				
F9.9B	86-00	CR6HS	050845				
F9.9C/D	98-03	DPR6EA-9	050865				
F13.5A	98-03	DPR6EA-9	050865				
F15A	98-03	DPR6EA-9	050865				
F20A	98-01	DPR6EA-9	050865				
F25A (E, ET)	98-02	DPR6EA-9	050865				
F25A (MH)		DPR6EA-9	050865				
F30A	01-02	DPR6EA-9	050865				
F30 OHC	01-02	DPR6EA-9	050865				
F40A/B	00-02	DPR6EA-9	050865				
F40C		DPR5EA-9	050896				
F45A/AETL	98-	DPR6EA-9	050865				
F50A/B	95-02	DPR6EA-9	050865				
F60A	02-	DPR5EA-9	050896				
F80A	00-03	LFR5A-11	050862				
F100A	99-03	LFR5A-11	050862				
F115V-41 7L	99-03	LFR6A-11	050881				
F115A (FL-115A)		LFR6A-11	050881				
F150A (FL-150A)		LFR5A-11	050862				
FT8D		BR6HS-10	050880				
FT9.9A	98-	CR6HS	050845				
FT9.9D		DPR6EA-9	050865				
FT25B		DPR6EA-9	050865				
FT50B/BETL	98-	DPR6EA-9	050865				
FT50C/G		DPR6EA-9	050865				
FT60B/D		DPR5EA-9	050896				
FX700(FX-1)	95-	BR8HS	050854				
L140 BETO		BR9HS-10	050837				

BLOQUES DE MOTORES GM REMANUFACTURADOS

Los motores marinos están expuestos a condiciones de trabajo extremas. Muchos fabricantes de motores no tienen en cuenta los componentes especiales que éstos necesitan para satisfacer las duras exigencias del entorno marino.

Nuestro proceso de remanufacturación está adaptado para garantizar una navegación sin problemas, incluso para el trabajo más duro de motores marinos y barcos en cada uno de los ambientes marino.

Con más de cuarenta años de experiencia en el suministro a navegantes de motores marinos de alta calidad, aportamos fiabilidad y rendimiento a los navegantes de todo tipo.

Nuestros motores sustituyen a las marcas más populares del mercado como: **VOLVO PENTA, MARINE POWER, MERCUISER, PCM, CRUSADER, INDMAR.**

Además nuestros procesos de remanufacturación de alta calidad, líder en industria, aporta tranquilidad.

Aparte de nuestros procesos de remanufacturación de alta calidad, indicamos a continuación las características de los motores marinos:

- Falda de pistón recubierta de teflón hipereutéctico: para una óptima disipación, admite rango tolerancias.
- Conjunto con doble rodillo: fabricado en acero de alta resistencia, mejora del rendimiento y aumento de la durabilidad.
- Válvulas de acero inoxidable reforzadas: mejora el rendimiento y disminuye desgaste.
- Muelles de válvula reforzados: fabricados en aleación de alta resistencia, extremos reforzados, asegurando el funcionamiento tanto en el escape como la admisión.
- Bielas y cojinetes fabricados con materiales de 1ª calidad Aros de hierro maleable: los aros fabricados en hierro maleable disponen de una excelente resistencia trabajando sin necesidad de cobertura externa. Gran resistencia a las roturas.
- Juntas de culata reforzadas con anillos de acero: aunque el acero inoxidable es más costoso debido a sus ventajas (reduce la corrosión y optimiza la compresión) es una apuesta segura !

La garantía de los motores remanufacturados es de 1 año.

Motores remanufacturados en base General Motors tipo 262 / 4.3L / 6 cilindros en V

Referencia	Nº Bloque	Nº Culata	Año aproximado	Descripción
262LA	14071177	14079268, 107, 476, 768, 996	85-86	2 retenes traseros, tapa de válvula montada en el centro. Potencia estimada entre 175 y 205 hp.
262LB	553, 683	14079268, 066, 103, 107, 476, 768, 996	86-88	1 retén trasero, tapa de válvula montada en el centro. Potencia estimada entre 175 y 205hp.
262LC	011, 611, 867	066, 103, 107, 476, 768, 996	87-92	Bloque V generación, varilla en la parte derecha. Tuchos planos, 1 reten trasero. Potencia estimada de 205hp.
262LG	14099090	10235772, 12556140	92-97	Tuchos hidraulicos de rodillo con eje de balancín, 6 tornillos en tapa de distribución, retén trasero de una pieza, bomba de combustible eléctrica.
262LI	535, 10227196, 10227359, 10227534	10238181, 10240209, 14099064	96-99	Tuchos hidraulicos de rodillo con eje de balancín, 10 tornillos en tapa de distribución, reten trasero de una pieza. Bomba de combustible eléctrica.

Motores remanufacturados en base General Motors tipo Vortec 350/5.7L/8 cilindros en V.

Referencia	Nº Bloque	Nº Culata	Año aproximado	Descripción
262LJ	090	113	2000	Tuchos hidraulicos de rodillo. Culata con 8 tornillos de fijación al colector de admisión. Tapa cadena distribución de plástico. Bomba de combustible eléctrica.

Motores remanufacturados en base General Motors tipo 262/4.3L/6 cilindros en V.

Referencia	Nº Bloque	Nº Culata	Año aproximado	Descripción
262LF	061, 073, 756	064, 181, 209, 626	92-96	Lifter de rodillo sin eje calibrado. Bomba de combustible eléctrica. Potencia estimada entre 175 y 205 hp.
262LD	196, 359, 534, 535	064, 181, 209	92-97	Lifter de rodillo con eje calibrado. Numero de eje calibrado 10224542 o 10172748. Tiene 10 tornillos en la tapa de distribución. Bomba eléctrica. Potencia estimada entre 175 y 205 hp.
262LE	196, 359, 534, 535	064, 181, 209	95-99	Lifter de rodillo sin eje calibrado. Tiene 6 tornillos en la tapa de distribución, 14 en el carter de aceite y 12 en el colector de admisión. Bomba eléctrica. Potencia estimada entre 175 y 205 hp.

Motores remanufacturados en base General Motors tipo 305/5.0L/8 cilindros en V.

Referencia	Nº Bloque	Nº Culata	Año aproximado	Descripción
305LA	14016381, 14010203, 14010202, 14010201, 361797, 371, 776, 777, 778, 909, 979	14022601, 14022301, 14014416, 462424, 357841, 354, 434, 741	76-85	2 retenes traseros, tornillos de tapa de válvula montados en el perímetro. Potencia estimada entre 200 y 230 hp.
305LB	14102058, 14093627, 14088551, 535	14022601, 14022301, 14014416, 434, 741	85-87	Lifters planos, 1 reten trasero, tornillos de tapa de válvula montados en el perímetro. Potencia estimada entre 200 y 230 hp.
305LC	14102058, 14093627, 14088551, 535	14102187, 14101081	87-95	12 tornillos en colector de admisión, tapa de distribución metálica, 1 reten trasero, tornillos de tapa de válvula montados en el centro. Potencia estimada entre 185 y 220hp.

Motores remanufacturados en base General Motors tipo 305/5.0L/8 cilindros en V.

Referencia	Nº Bloque	Nº Culata	Año aproximado	Descripción
305LE	878	187	95-99	Con 8 o 10 tornillos en tapa de distribución de plástico. 12 tornillos en colector de admisión. Potencia estimada entre 200 y 230 hp.
305LF	878	059, 520, 620	96-99	Con 8 tornillos en colector de admisión. Tapa de distribución de plástico. Potencia estimada entre 200 y 230 hp.

Motores remanufacturados en base General Motors tipo 350/5.7L/8 cilindros en V

Referencia	Nº Bloque	Nº Culata	Año aproximado	Descripción
350LA	010, 014, 245, 379, 388, 618, 678	487, 624, 882, 993	67-85	Varilla en la parte derecha o izquierda del bloque, 2 retenes traseros, tornillos de tapa de válvula montados en el perímetro. Potencia estimada de 260 hp.
350LB	14101148, 14093638, 14088548, 10054727, 526	487, 624, 882, 993	86-87	1 retén trasero, tornillos de tapa de válvula montados en el perímetro. Potencia estimada de 260 hp.

Motores remanufacturados en base General Motors tipo 350/5.7L/8 cilindros en V

Referencia	Nº Bloque	Nº Culata	Año aproximado	Descripción
350LC	14101148, 14093638, 14088548, 10054727, 526	083, 193, 217	88-95	12 tornillos en el colector, 1 retén trasero, tornillos de tapa de válvula montados en el centro. Potencia estimada de 260 hp.
350LE	880	083, 193, 217	95-99	1 retén trasero, 12 tornillos colector de admisión, tapa de distribución de plástico, lifters de rodillo. Potencia estimada de 260 hp.
350LF	880	062, 906	95-99	1 retén trasero, 8 tornillos colector de admisión, tapa de distribución de plástico, agujero para bomba de combustible mecánica. Potencia estimada de 260 hp.

Motores remanufacturados en base General Motors tipo 454/7.4L

Referencia	Nº Bloque	Nº Culata	Año aproximado	Descripción
454LA	286, 289, 293, 321, 445, 512, 775, 959	039, 045, 049, 186, 236, 292, 326, 360, 416, 781	73-90	Bloque IV Gen.2 retenes traseros. Potencia estimada de 330 hp.
454LB	182, 297, 313	088, 156, 932	91-97	Bloque V Gen. 1 retén trasero. Potencia estimada de 330 hp.
454LC	182	088, 156, 923	91-97	Bloque V Gen., 1 reten trasero, 6 tornillos de distribución. Potencia estimada de 330hp.
454LD	297	279	96-99	Bloque V6 Gen., 1 reten trasero, 6 tornillos de distribución. Potencia estimada de 330hp.
454LE	297	156	96-03	Bloque VI Gen., 1 reten trasero, 6 tornillos de distribución. Potencia estimada de 330hp.

Motores remanufacturados en base General Motors tipo 502/8.2L

Referencia	Nº Bloque	Nº Culata	Año aproximado	Descripción
454LA	286, 289, 293, 321, 445, 512, 775, 959	039, 045, 049, 186, 236, 292, 326, 360, 416, 781	73-90	Bloque IV Gen.2 retenes traseros. Potencia estimada de 330 hp.



PRONAUTIC

Marine Equipment

www.pronautic.net

Solicita tu clave de acceso a **informatica@pronautic.net**
o a nuestro equipo de ventas y accede a través de nuestra
página web a:

-
- Consultas de stocks
-
- Tamita pedidos
-
- Consulta albaranes, Facturas
-
- Todos nuestros catálogos y folletos
-
- Ofertas y promociones
-
- Área Outlet
-

Múltiples aplicaciones a un solo click

Sierra® High Performance

SIERRA PRODUCTOS ALTO RENDIMIENTO

**18-5466
BOBINA ENCENDIDO
ALTO RENDIMIENTO**

1.5 ohm (aceite), negro - 8 cilindros:
Flame-Thrower 40,000 volt.
• Usar con el kit de encendido de conversión electrónica
• Puede ser usador por otros sistemas de encendido



**18-5469
BOBINA ENCENDIDO
ALTO RENDIMIENTO**

3.0 ohm (aceite), negro - 4 & 6 cilindros:
Flame-Thrower 40,000 volt.
• Usar con el kit de encendido de conversión electrónica
• Puede ser usador por otros sistemas de encendidos



**18-5472
BOBINA ENCENDIDO
ALTO RENDIMIENTO**

0.6 ohm (aceite), negro - 4, 6, & 8 cilindro: Flame-Thrower 45,000 volt.
• Resistencia bobina 0.6 Ohm diseñada para utilizar con kits de altas prestaciones.
• Compatible con sistemas de descarga



**18-8898
BOBINA**

Altas prestaciones para encendido o puente



**18-8899
BOBINA**

Altas prestaciones para encendido II o flamethrower



**18-29716
BOBINA SALIDA**

Reemplaza: Mallory 29216
Para: Mallory 8 cilindro

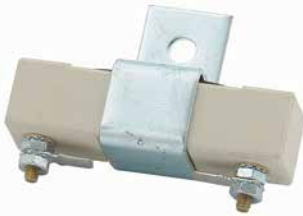

**18-29904
RESISTENCIA BOBINA**

Reemplaza: Mallory 700
1.5Ω- 0.75Ω Resistencia variable



**18-28150
CABLE SEPARADOR / AZUL**



**18-28151
CABLE SEPARADOR / NEGRO**

PROMASTER® SERIE BOBINA ENCENDIDO



Nuestra bobina PROMASTER® ofrece mayor rendimiento a través del tiempo de subida más rápido y mayor duración. Una resistente fibra de vidrio, carcasa de poliéster y lleno de aceite garantiza una larga vida útil sin pérdida de energía de un arco eléctrico. Todas las bobinas PROMASTER® incluyen terminales de contacto roscado de latón y tipo bujía post secundaria para una mejor retención del cable de la bobina. Para uso con Mallory UNILITE® encendido, Contacto Magnético Contacto Breakerless y/o electrónicos anticipados de equipo. Efectivo a 8000 RPM.

**18-29720
Reemplaza: Mallory 29440M**

Para uso Mallory UNILITE Ignition, contacto magnético. Efectivo a 8000 RPM. (resistencia externa requerida)

Sierra® High Performance



18-28175
MARC. PARA CABLES



18-5285
KIT CONVERSIÓN ELECTRÓNICO ALTO RENDIMIENTO
Para: 4 Cilindro Delco Distribuidor



18-5286
KIT CONVERSIÓN ELECTRÓNICO ALTO RENDIMIENTO
Para: 6 Cilindro Delco Distribuidor



18-5288
KIT CONVERSIÓN ELECTRÓNICO ALTO RENDIMIENTO
Para: Mayoría Prestolite V-8 Distribuidor con tapa de presión



18-5289
KIT CONVERSIÓN ELECTRÓNICO ALTO RENDIMIENTO
Para: Mayoría Prestolite Distribuidores con tapa tornillos



18-5290
KIT CONVERSIÓN ELECTRÓNICO ALTO RENDIMIENTO
Para: Mayoría Mallory YL o YD 8 cilindro Distribuidor con rotación normal e inversa



18-5477
DISTRIBUIDOR ELECTRÓNICO
Para: Motores Ford 302 V-8
Reemplaza kit tapa/Rotor 18-5266



18-5478
DISTRIBUIDOR ELECTRÓNICO
Para: Chrysler LA serie V-8



18-5479
DISTRIBUIDOR ELECTRÓNICO
Para: GM V-8-rotación reversa



18-5480
KIT COMPLETO CONVERSIÓN ENCENDIDO
Para: GM SB & BB con altura de cubierta standard



18-5481
KIT CONVERSIÓN ELECTRÓNICO ALTO RENDIMIENTO
Para: Ford V-8 351 Windsor
Reemplaza tapa/kit rotor: 18-5266



18-5482
KIT CONVERSIÓN ELECTRÓNICO ALTO RENDIMIENTO
Para: Motores Ford V-8 351 Cleveland, 351M, 400, 429 y 460. Reemplaza Tapa/kit rotor: 18-5266

Sierra®

High Performance



18-5483
DISTRIBUIDOR ELECTRÓNICO ALTO RENDIMIENTO

Para: Bloque de motor marino Chevrolet pequeño grande(altura de cubierta estándar).
Reemplaza tapa/kit rotor: 18-5266



18-5473
TAPA DISTRIBUIDOR

Tapa distribuidor negro con macho
Para distribuidor Flamethrower



18-5474
TAPA DISTRIBUIDOR

Tapa distribuidor rojo con terminales macho. Para distribuidor flamethrower.



18-6842
ALTERNADOR

Reemplaza: 983424, 836, 247
Para: 37-63A Aplicación



18-6975
ALTERNADOR (Universal)

Para: Alternator 160A, montaje universal Delco CS1300 correa, 6 ranuras y poleas incluidas



18-6834
MOTOR ARRANQUE

Reemplaza: GM motores Universal
Se usa en todos los motores GM con cualquiera 14 1/4" volantes o 12 3/4" volantes



18-6835
MOTOR ARRANQUE

Reemplaza: GM motores Universal 3 terminal
Se usa en todos los motores GM con cualquiera 14 1/4" o 12 3/4" volantes

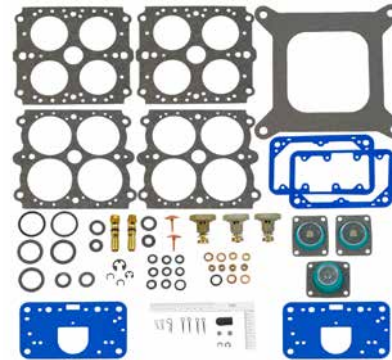

18-7751
KIT CARBURADOR

Reemplaza: 13220
Para: GM 420 V8 454 (1987-89), GM 425 V8 454 (1990-93), GM 425 (Gen V) V8 454 (1992-93), 440 TRS GM 454 (1983-86), GM 450 V8 454(1995-96), 460 TRS V8 482 (1983-86), GM 465 V8 502 (1990-92), GM 465 (Gen V) V8 502 (1992-94), 500 (Gen+) GM 502 V8 (1999), 500 (Gen V) 502 V8 (1994-98), 500 Bulldog 540 V8 (1990-01)



18-7637
CARBURADOR (REMANUFACTURADO)

(Incluye junta)
600 CFM Holley 4V



18-7638
CARBURADOR (REMANUFACTURADO)

600 CFM Holley 4V-entrada lateral



18-7775
SOPORTE FILTRO
3/8" Aluminio



18-7776
SOPORTE FILTRO
3/8" Acero inox



18-7232
ANTI-DEFLAGRANTE
Reemplaza: Crusader 33628
Mercruiser 57882, 57882T

Sierra® High Performance



**18-7790
KIT FILTRO COMBUSTIBLE**
Kit completo contiene: alojamiento,
Elemento & conectores para
1/4", 5/16", & 3/8" líneas combustible
Use filtro 18-7791



**18-7945C
FILTRO SEPARADOR COMBUSTIBLE
AGUA (cromado)**
Reemplaza: Mercury 35-802893Q
Yamaha ABB-FUELF-IL-TR



**18-7824C-1
FILTRO ACEITE (Cromado)**
Corto GM
Reemplaza:
Chris-Craft 16.81-08746
Crusader 201104, Indmar: 50-1001
Mercuriuser 35-802885Q, 32716, 866340Q02, Q03,
866340K01
Mercuriuser Vazer, OMC 173232, 502902
Pleasurecraft R077002
Volvo-Penta 835440
Yamaha YSC-10231-20-0C
Rosca: 13/16" x 16NPT



**18-7866
FILTRO COMBUSTIBLE**
Reemplaza: Yamaha MAR-FUELF-IL-TR
Gran capacidad - 6"
10 Micron



**18-8114
MANGUITO COMBUSTIBLE**
Para bomba combustible con conexión de carburador.
Reemplaza tubería de cobre o de acero 3/8" X 31" PTFE
manguera compuesta con terminal 5/8"-18 terminal,
5/8"-18 90° un extremo. SAE J1527 tipo A1



**18-8115
MANGUITO COMBUSTIBLE**
Para bomba combustible con conexión de carburador.
Reemplaza tubería de cobre o de acero 3/8" X 25"
PTFE manguera compuesta con terminal 5/8"-18
terminal, 5/8"-18 90° un extremo. SAE J1527 tipo A1



**18-7332
BOMBA ELÉCTRICA COMBUSTIBLE**
Incluye soporte y tornillería para el montaje
43 GPH - 7 PSI Max. - 1/4 NPSF for 3/8 manguera
- Funciona tanto con gasolina como con diesel - Sólo 24 V.



**18-34110
BOMBA ELÉCTRICA COMBUSTIBLE**
Reemplaza: Mallory 4110M
110GPH MARINE



**18-34140
BOMBA ELÉCTRICA COMBUSTIBLE**
Reemplaza: Mallory 4140M
140GPH MARINE



**18-35101
PLATINA
BOMBA COMBUSTIBLE**
Reemplaza: Mallory 5421
Para: Chevrolet 265-400



**18-35102
PLATINA
BOMBA COMBUSTIBLE**
Reemplaza: Mallory 5422
Para: Chevrolet 396-502 & Ford 289-351W



**18-35435
BOMBA ELÉCTRICA COMBUSTIBLE**
Universal - 12V 2.5-4.5 psi @ 16.8 gph 1/8" Tubo
con rosca hembra



18-35436
BOMBA COMBUSTIBLE ELÉCTRICA
 Universal - 12V 5-9 psi @ 16.8 gph 1/8"
 Tubo con rosca hembra



18-7627
COLECTOR ADMISIÓN
 Bloques pequeños GM con culata vortec.



18-7628
COLECTOR ADMISIÓN
 Bloques pequeños GM con culata Vortec y circuito cerrado para agua salada



18-7489
CARBURADOR WEBER 750

- Cuadrada
- Pulido
- Estrangulador eléctrico
- Calibrado y testado para un alto rendimiento.



18-1989
TERMOSTATO ALOJAMIENTO
 Reemplaza: 8M0061381, 861006A1
 Acero inoxidable
 Use 18-1989K kit servicio termostato para reemplazar partes



18-1989K
KIT SERVICIO TERMOSTATO
 kit servicio para 18-1989 termostato aloj.



18-4487
COLECTOR ADMISIÓN, HIERRO FUNDIDO
 Para: Bloques pequeños GM, 1987-1995.



18-4488
COLECTOR ADMISIÓN, HIERRO FUND.
 Para: Bloques pequeños GM, vortec



18-4506
PLACAS GUÍA
 Bloque grande GM con 5/16" varilla de empuje



18-4508
KIT TORNILLERÍA
 Kit de tornillos de alto rendimiento de bloque peq. GM



18-4492
CONJUNTO BALANCIN
 Reemplaza: MerCruiser 35329, F3746241, F11100014, F11100495
 Para: MCM/MIE Gm V6 & V8(283, 305 & 350 cid)



18-4507
KIT BALANCINES (4 VÁLVULAS)
 Bloque grande GM

CONJUNTO CULATA

Todas las culatas son nuevas y montadas con válvulas de acero inoxidable, asientos de válvula, muelles de válvula, semi-conos y retenes.
Todas las culatas GM utilizan esparragos de alto rendimiento en lugar de los originales.



18-4485
CULATA
 Reemplaza: MerCruiser 938-883490R1, 938-883490, 938-883490R50, 938-884741R, 938-884741 R50
 Para: 5.7L V-8 GM (1987-95) con 12 pernos en el colector de admisión.
 Tornillos de fijación (4 dentro de los pernos del colector de admisión a 23 grados), tapas de válvula de montaje central



18-4485HP
CULATA

 Para: Medio GM bloque pequeño 5.7L alto rendimiento.
 Completamente montado con deslizador revisada y cámaras de combustión. Agregar 30hp para balance de motor sin modificaciones adicionales.



18-4486
CULATA
 Reemplaza: MerCruiser 938-883297 1, 938-803860T, 938-883297R1
 Para: 5.7L V-8 GM Vortec (1996-Sup) con 8 tornillos en el colector de entrada.

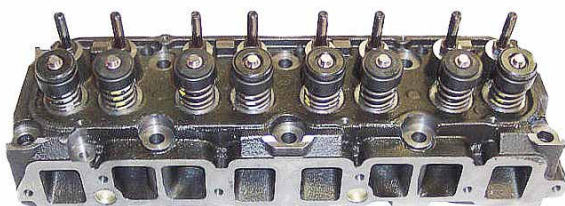

18-4486HP
CULATA

 Para: Vortec GM pequeño bloque 5.7L alto rendimiento
 Completamente montado con deslizador revisada y cámaras combustión. Agregar 30hp para balance de motor sin modificaciones adicionales.



18-4489
CULATA
 Reemplaza: MerCruiser 936-810840/986767, 938-884739R01
 Para: 2.5L/3.0L GM (1968-95) (no MerCruiser LX modelos) (1968-95)



18-4484HP
CULATA

 Para: Rapido GM bloque pequeño 5.7L alto rendimiento
 Completamente montado con deslizador revisada y cámaras combustión. Agregar 30hp para balance de motor sin modificaciones.



**18-4493HP
CULATA**
Para: bloque grande GM
Rendimiento hierro fundido



**18-4491
CULATA**
Reemplaza: MerCruiser 938-827178
Reemplaza 4.3L Vortec V-6 (1996-sup) con tornillo en los esparragos del brazo (válvula no ajustable), colector de admisión con 8 tornillos, tapa válvula centrada. NOTA: No utilizar con motores con balancines de fábrica.



**18-4501
CULATA**
Para: 5.0L Vortec

**18-4501HP
CULATA**
Para: Vortec GM bloques pequeños 5.0L
Camisas y cámaras de combustión revisados.
Añada 30 hp al motor sin modificaciones.



**18-4497
TAPA DISTRIBUCIÓN**
Para: bloques pequeños GM-(1986-1995)



**18-56870
TAPA DISTRIBUCIÓN**
Reemplaza: Mercury 59341A1
Para: GM 3.0L con tapa metálica

**18-4511
TAPA DISTRIBUCIÓN**
GM 4.3L- Compuesto con sensor a babor
Incluye junta & front seal.

**18-4512
TAPA DISTRIBUCIÓN**
GM 4.3L Compuesto sin sensor a babor
Incluye junta & retén frontal.



**18-4513
TAPA DISTRIBUCIÓN**
GM 5.0L/5.7L- Compuesto con puerto sensor incluye junta y retén frontal.

**18-4514
TAPA DISTRIBUCIÓN**
GM 5.0L/5.7L- Compuesto con sensor a babor incluye junta y retén frontal.

**18-4516
ARO ENGRANAJE-VOLANTE**
14" GM volante con 168 dientes

**18-4517
ARO ENGRANAJE-VOLANTE**
12" GM volante con 153 dientes



**18-4518
VOLANTE**
14" 4.3L V-6, 1 Pieza principal y hasta 1987. Montaje inferior montado en el bloque de arranque (aplicación)

**18-4519
VOLANTE**
14" 5.0/5.7L, 1 Pieza principal y hasta 1987. Montaje inferior montado en el bloque de arranque (aplicación).

**18-4521
VOLANTE**
14" bloque pequeño GM, 2 Pieza principal, antes de 1987. Montaje inferior montado en el bloque de arranque (aplicaciones).

**18-4522
VOLANTE**
14" 454, Gen IV con 2 Pieza principal, antes de 1987. Montaje inferior montado en el bloque de arranque (aplicaciones).



**18-4523
VOLANTE**
14" 454, Gen V & VI con 1 Pieza principal, antes de 1987. Montaje inferior montado en el bloque de arranque (aplicaciones)..



**18-4726
VÁLVULA RETÉN**
Para: GM V-6 & V-8



**18-4727
VÁLVULA MUELLE**
Para: GM vortec válvula muelle estilo



**18-4728
VÁLVULA MUELLE**
Para: GM standard válvula muelle estilo



**18-4729
VÁLVULA RETENEDORA,
VORTEC**
Para: GM V-6 & V-8



**18-4730
VÁLVULA RETENEDORA**
Para: GM V-6 & V-8



**18-4731
BLOQUEO DE VÁLVULA**
Para: GM V-6 & V-8



**18-4732
VÁLVULA ADMISIÓN (1.94")**
Para: GM V-6 & V-8



**18-4733
VÁLVULA ESCAPE (1.50")**
Para: GM V-6 & V-8



**18-4734
VÁLVULA ADMISIÓN
(1.84")**
Para: GM V-6 & V-8



**18-4735
VÁLVULA ADMISIÓN (2.02")**
Para: GM V-6 & V-8



**18-4736
VÁLVULA ESCAPE (1.60")**
Para: GM V-6 & V-8



**18-4737
TORNILLO**
Para: GM motores V-6 & V-8



**18-8962
CONJUNTO TAPA VÁLVULA**
Para: 4.3L V-6 (1986 & sup) metal



**18-8963
CONJUNTO TAPA VÁLVULA**
Para: bloque pequeño GM (1986 & sup)



KIT TAPONES BRONCE
Elimina la posible oxidación. El kit incluye todos los tapones necesarios para un motor.

Ref No.	Aplicación
18-56481	Chevrolet 265-400

EDELBROCK® CARBURADORES



18-34080
CARBURADOR 600 CFM
Para: V-6 y pequeño V-8



18-34081
CARBURADOR 750 CFM
Para: Bloque grande y pequeño GM



EDELBROCK® COLECTORES DE ADMISIÓN



18-34082
COLECTOR DE ADMISIÓN
DE AGUA
Para: Bloque pequeño GM, 1955-1986



18-34083
COLECTOR DE ADMISIÓN
DE AGUA
Para: Bloque pequeño GM, 1987-1995



18-34084
COLECTOR DE ADMISIÓN
DE AGUA
Para: Bloque grande GM

MULTIPLES KITS PARA MOTORES MARINOS FORD Y CHEVROLET

- Para mayoría de versiones de: Chevrolet en línea 4 & 6 cilindros, motores V6 & V8 y Ford 5.0 L & 5.8L V8
- Mínimo inventario cubriendo la mayoría de motores del mercado
- Utiliza kits de juntas genericos entre las diferentes marcas del mercado, (ej: 350 CID (5.7L) Crusader y Mercruiser utilizarian el mismo bloque corto y kit de juntas, pero usarian diferentes kits de juntas para los colectores escape)

CHEVY 4 cil. 153/2.5L 1965-88 ③

CHEVY 4 cil. 181/3.0L 1973-84 ③

CHEVY 4 cil. 181/3.0L 1985-89 (4 cil. 181/3.0L HO 1990-98 ③)

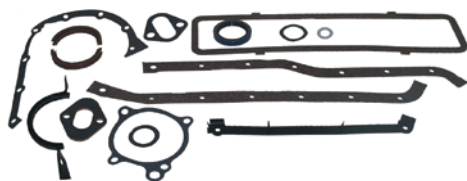

18-1271 ① ③

CONJUNTO DE JUNTAS CON BLOQUE CORTO

— CONTIENE —

Descripción	Ref #
Junta cárter aceite	18-0466
Juntas del cigüeñal delantero	18-1213
Juntas cigüeñal trasero	18-1211
Tapa varilla empuje	18-0328
Junta bomba agua	18-0327
Junta bomba comb. montaje	18-0889
Junta bomba comb. montaje	NSS
Junta tapa	18-0887
Junta montaje distribuidor	18-0948
Junta montaje distribuidor	18-0874



18-1274

CONJUNTO CULATA

— CONTIENE —

Descripción	Ref #
Culata	18-2946
Junta montaje carburador	18-0994
Carb. junta montaje	18-0356
Junta alojamiento termostato	18-0164
Junta tapa válvula	18-0347
Retenes válvula (8)	18-0518

GM 4 cil. 3.0L

18-1206

CONJUNTO DE JUNTAS DE BLOQUE CORTO

— CONTIENE —

Descripción	Ref #
Retén frontal	18-1213
Retén posterior	18-0519
Junta montaje bomba combustible	18-0889
Junta montaje bomba combustible	NSS
Junta tapa varilla empuje	18-2815
Junta montaje distribuidor	18-0874
Junta montaje distribuidor	18-0948
Junta tapa distribución	18-0887
Junta bomba combustible	18-0327



4 cil. 3.7L Mercruiser 470

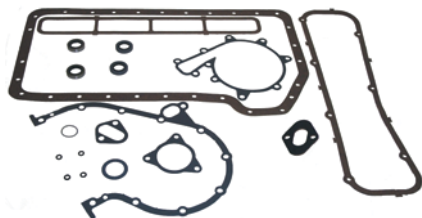

18-1276

CONJUNTO DE JUNTAS BLOQUE CORTO

— CONTIENE —

Descripción	Ref #
Retén aceite	18-2014
Junta montaje	NSS
Junta montaje distribuidor	18-0874
Junta montaje bomb. comb.	18-0889
Aro	NSS
Retén bomba agua	18-0172
Aro	18-7145
Junta cárter aceite	18-4366
Temporizador de bomba agua	
Junta tapa	NSS



18-1277

CONJUNTO CULATA

— CONTIENE —

Descripción	Ref #
Junta admisión	18-0158
Junta Quadrajét	18-2848
Junta tapa valvulas	NSS
Culata	18-3878
Junta montaje colector escape	18-0956-1
Junta válvula	NSS

① Excepto modelos con tapa de varillas empuje

② No incluye juntas colector

③ Para modelos de unico retén trasero cigüeñal usar 18-120 NSS.

No se vende por separado

CHEVY 6 Cil. 250/4.1L

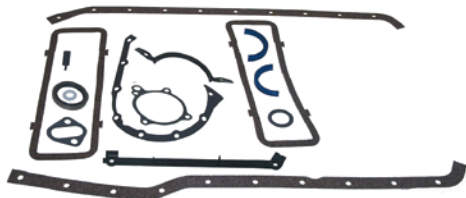

18-1255
KIT JUNTAS BLOQUE CORTO
(24 tornillos fij. carter)

— CONTIENE —

Descripción	Ref #
Junta carter	18-0340
Retenes delanteros	18-1213
Retenes traseros cigüeñal	18-1211
Tapa	18-0329
Junta bomba agua	18-0327
Junta montaje bomba comb.	18-0889
Junta tapa	18-0887
Junta montaje distribuidor	18-0874

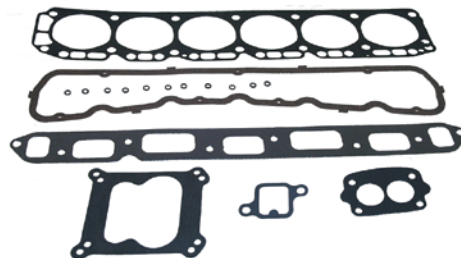

18-1264
KIT JUNTA CULATA

— CONTIENE —

Descripción	Ref #
Junta culata	18-3881
Junta montaje carb. 4BBL	NSS
Junta montaje carb. 2BBL	18-0356
Junta colector escape	18-2830-1
Junta montaje	18-0164
Junta tapa válvula	18-0346
Retenes válvula (8)	18-0518

CHEVY V-6 229/3.8L Y 4.3L (hasta 1985)



18-1270 *
KIT JUNTAS BLOQUE CORTO

— CONTIENE —

Descripción	Ref #
Junta carter	18-0405
Junta tornillo drenaje	18-0905
Retenes delanteros cigüeñal	18-1213
Retén cigüeñal trasero	18-0519
Retén cigüeñal	18-0322
Junta montaje bomba agua	18-0891
Junta bomba combustible	NSS
Junta montaje bomba comb.	18-0889
Junta	18-0976
Junta	NSS

* Se requiere un retén cigüeñal trasero
(No incluido) adicional

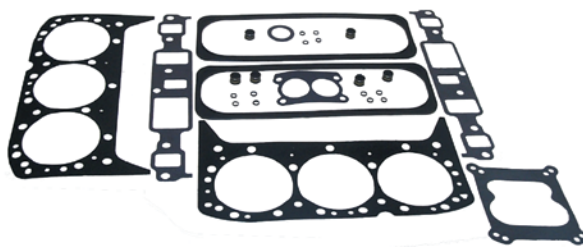

18-1275 ①
KIT JUNTA CULATA

— CONTIENE —

Descripción	Ref #
Junta culata	18-3879
Junta montaje carb. 2BBL	18-0994
Junta montaje carb. 4BBL	18-0463
Junta colector	18-4408
Junta tapa válvula	18-0311
Retenes válvula (6)	18-4024
Retenes válvula (12)	18-0518
Junta montaje distribuidor	18-0874

CHEVY V-6 262/4.3L - 1 único retén trasero
CHEVY V-6 262/4.3L GEN II - 1 único retén trasero
1986-1995



18-1270
KIT JUNTAS BLOQUE CORTO

— CONTIENE —

Descripción	Ref #
Junta carter	18-0405
Junta tornillo drenaje	18-0905
Retén delantero cigüeñal	18-1213
Retén trasero cigüeñal	18-0519
Retén cigüeñal	18-0322
Junta montaje bomba de agua	18-0891
Junta platina bomba de agua	NSS
Junta mont. bomb. comb	18-0889
Junta tapa cadena distribución	18-0976
Junta adaptador	NSS

* Se necesita un retén cigüeñal trasero
(No Incluido) adicional

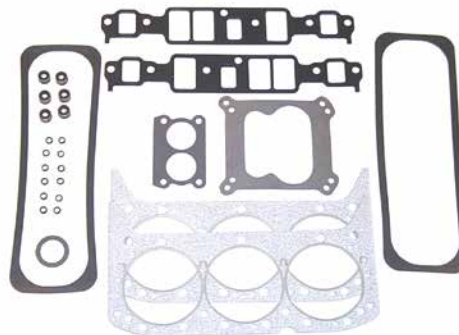

18-1278
KIT JUNTAS CULATA

— CONTIENE —

Descripción	Ref #
Junta culata	18-3879
Junta montaje carb. 2BBL	18-0994
Junta montaje carb. 4BBL	18-0463
Retenes válvula (6)	18-4024
Retenes válvula (12)	18-0518
Junta montaje distribuidor	18-0874
Juego de juntas admisión	18-1238
Junta tapa válvula (2)	18-0311

① No incluye junta carter

② No incluye juntas colector

NSS No se vende por separado

CHEVY V-8 305/5.0L
2 piezas retenes traseros
hasta 1985



18-1265
KIT JUNTAS BLOQUE CORTO
 Solo modelos varilla babor
 Izquierda (Rotación standard)

— CONTIENE —

Descripción	Ref #
Junta carter	18-0153
Junta tornillo drenaje	18-0905
Junta filtro aceite	18-0185
Retén delantero cigüeñal	18-1213
Retén trasero cigüeñal	18-1211
Junta montaje bomba agua	18-0891
Junta platina bomba agua	NSS
Junta platina bomba comb.	18-0876
Junta mont. bomb. comb.	18-0889
Junta tapa cadena distribución	18-0976
Junta adaptador	NSS

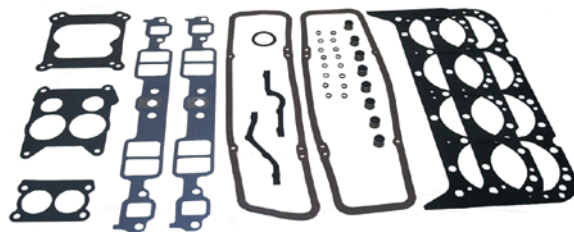

18-1266 ②
KIT JUNTA CULATA

— CONTIENE —

Descripción	Ref #
Junta culata	18-3876
Junta montaje carb. 2BBL	18-0994
Junta montaje carb. 4BBL	18-0463
Junta montaje carb. 4BBL	18-0462
Junta colector admisión	18-0868
Junta tapa válvula (2)	18-2845
Retenes válvula (8)	18-4024
Retenes válvula (16)	18-0518
Junta montaje distribuidor	18-0874

CHEVY V-8 305/5.0L (Rotación derecha)
2 piezas retenes traseros
hasta 1985

18-1266 ②
KIT JUNTA CULATA

— CONTIENE —

Descripción	Ref #
Junta carter	18-3876
Junta montaje carb. 2BBL	18-0994
Junta montaje carb. 4BBL	18-0463
Junta montaje carb. 4BBL	18-0462
Junta colector admisión	18-0868
Junta tapa válvula (2)	18-2845
Retenes válvula (8)	18-4024
Retenes válvula (16)	18-0518
Junta montaje distribuidor	18-0874

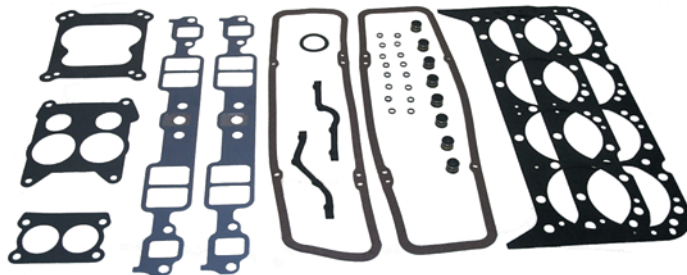

CHEVY V-8 305/5.0L GEN II
1 Pieza retén trasero
1986-1995

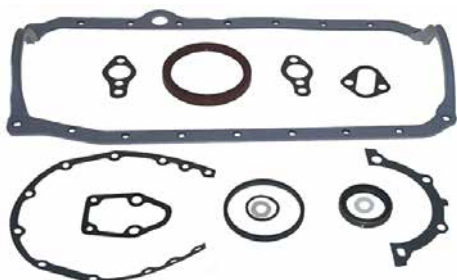

18-1268
KIT JUNTAS BLOQUE CORTO
 — CONTIENE —

Descripción	Ref #
Junta carter	18-1237
Junta tornillo drenaje aceite	18-0905
Junta filtro aceite	18-0185
Retén delantero cigüeñal	18-1213
Retén trasero	18-0519
Junta cojinete ppal. trasero	18-0322
Junta montaje bomba agua	18-0891
Junta platina bomba agua	NSS
Junta platina bomba combustible	18-0976
Junta montaje bomba combustible	18-0889

18-1267 ②
KIT JUNTA CULATA

— CONTIENE —

Descripción	Ref #
Junta culata	18-3876
Junta montaje carb. 2BBL	18-0994
Junta montaje carb. 4BBL	18-0463
Junta montaje carb. 4BBL	18-0462
kit juntas colector admisión	18-0868
Junta tapa válvula (2)	18-0664
Retenes válvula (8)	18-4024
Retenes válvula (16)	18-0518
Junta montaje distribuidor	18-0874

① no incluye junta carter

② No incluye junta colector

NSS No se vende individual

CHEVY V-8 305/5.0L GEN II (Rotación derecha)
1 pieza retenes traseros
1986-1995

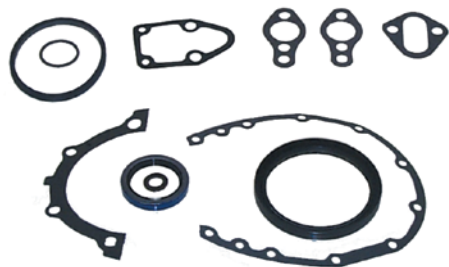

18-1263 ①
KIT JUNTAS BLOQUE CORTO
 — CONTIENE —

Descripción	Ref #
Junta tornillo drenaje aceite	18-0905
Junta filtro aceite	18-0185
Retén de empuje	18-1213
Junta cojinete pal. trasero	18-0322
Junta montaje bomba agua	18-0891
Junta platina bomba agua	18-0893
Junta platina bomba agua	NSS
Junta platina bomba comb.	18-0876
Junta montaje bomb. comb.	18-0889
Junta tapa cadena distribuidor	18-0976

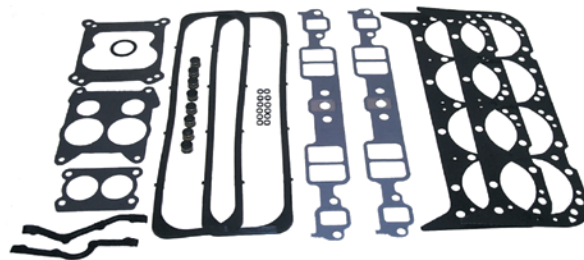

18-1267 ②
KIT JUNTA CULATA
 — CONTIENE —

Descripción	Ref #
Junta culata	18-3876
Junta mont. carb. 2BBL	18-0994
Junta mont. carb. 4BBL	18-0463
Junta mont. carb. 4BBL	18-0462
Juego juntas colector admisión	18-0868
Junta tapa válvula (2)	18-0664
Retenes válvula (8)	18-4024
Retenes válvula (16)	18-0518
Junta montaje distribuidor	18-0874

CHEVY V-8 350/5.7L
2 Piezas retenes traseros
hasta 1985

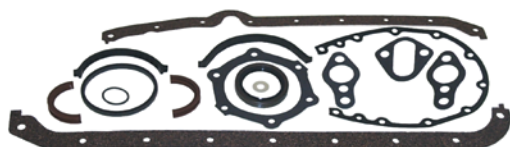

18-1265 *
KIT JUNTAS BLOQUE CORTO
 Solo modelos varilla babor
 Izquierda (Rotación estándar)
 — CONTIENE —

Descripción	Ref #
Junta carter	18-0153
Junta tornillo drenaje aceite	18-0905
Junta filtro aceite	18-0185
Retén de empuje	18-1213
Retén trasero	18-1211
Junta montaje bomba agua	18-0891
Junta platina bomba combustible	NSS
Junta platina bomba combustible	18-0876
Junta montaje bomba combustible	18-0889
Junta tapa cadena distribución	18-0976
Junta adaptación	NSS

* Excepto modelos Stbd dip stick

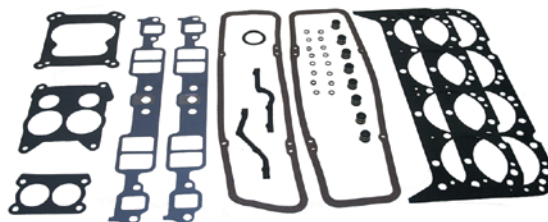

18-1266 ②
KIT JUNTAS CULATA
 — CONTIENE —

Descripción	Ref #
Junta culata	18-3876
Junta montaje carb 2BBL	18-0994
Junta montaje carb 4BBL	18-0463
Junta montaje carb 4BBL	18-0462
Junta colector admisión	18-0868
Junta tapa válvula (2)	18-2845
Retenes válvula (8)	18-4024
Retenes válvula (16)	18-0518
Junta montaje distribuidor	18-0874

CHEVY V-8 350/5.7L (rotación derecha)
2 piezas retenes traseros
hasta 1985

18-1266 ②
KIT JUNTAS CULATA
 — CONTIENE —

Descripción	Ref #
Junta culata	18-3876
Junta carburador montaje 2BBL	18-0994
Junta carburador montaje 4BBL	18-0463
Junta carburador montaje 4BBL	18-0462
Junta colector admisión	18-0868
Junta tapa válvula (2)	18-2845
Retenes válvula (8)	18-4024
Retenes válvula (16)	18-0518
Junta montaje distribuidor	18-0874

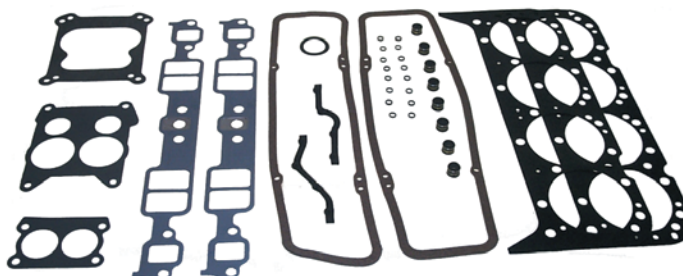

① No incluye junta de carter

② No incluye juntas de colector

NSS No se vende individual

CHEVY V-8 350/5.7L GEN II
1 Retén trasero
1986-1995

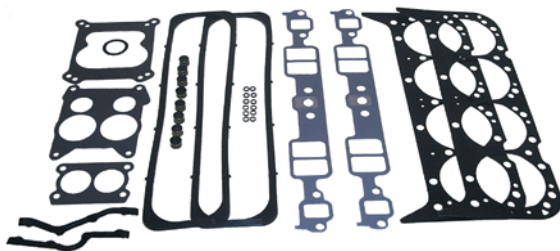

18-1267^②

KITS JUNTA CULATA

— CONTIENE —

Descripción	Ref #
Junta culata	18-3876
Junta montaje carb. 2BBL	18-0994
Junta montaje carb. 4BBL	18-0463
Junta montaje carb. 4BBL	18-0462
Juego juntas colector admisión	18-0868
Junta tapa válvula (2)	18-0664
Retenes válvula (8)	18-4024
Retenes válvula (16)	18-0518
Junta montaje distribuidor	18-0874

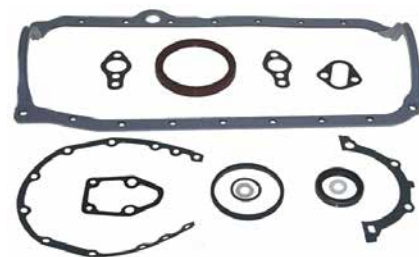

18-1268

KITS JUNTAS BLOQUE CORTO

— CONTIENE —

Descripción	Ref #
Junta carter	18-1237
Junta tornillo drenaje aceite	18-0905
Junta filtro aceite	18-0185
Retén delantero cigüeñal	18-1213
Retén trasero	18-0519
Retén cojinete ppal.trasero	18-0322
Junta montaje bomba agua	18-0891
Junta platina bomba agua	NSS
Junta platina bomba combustible	18-0976
Junta montaje bomba comb.	18-0889
Junta tapa cadena distribución	18-0468

CHEVY V-8 350/5.7L GEN II (Rotación derecha)
1 Retén trasero
1986-1995

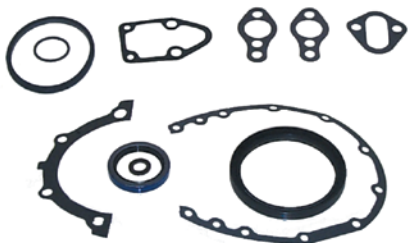

18-1263^①

KIT JUNTAS BLOQUE CORTO

— CONTIENE —

Descripción	Ref #
Junta tornillo drenaje	18-0905
Junta filtro aceite	18-0185
Retén empuje	18-1213
Junta trasera cojinete ppal.	18-0322
Junta montaje bomba agua	18-0891
Junta platina bomba agua	NSS
Junta platina bomba combustible	18-0876
Junta montaje bomba comb.	18-0889
Junta tapa cadena distribución	18-0468

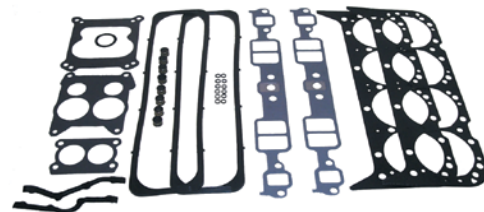

18-1267^②

KITS JUNTAS CULATA

— CONTIENE —

Descripción	Ref #
Junta culata	18-3876
Junta montaje carb. 2BBL	18-0994
Junta montaje carb. 4BBL	18-0463
Junta montaje carb. 4BBL	18-0462
Kit juntas colector admisión	18-0868
Junta tapa válvula (2)	18-0664
Retenes válvula (8)	18-4024
Retenes válvula (16)	18-0518
Junta montaje distribuidor	18-0874

CHEVY V-8 454/7.4L

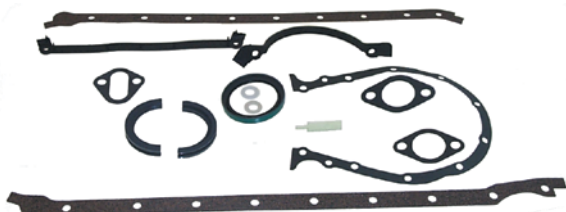

18-1256 *

KIT JUNTAS BLOQUE CORTO

— CONTIENE —

Descripción	Ref #
Junta carter	18-0348
Junta tornillo drenaje aceite	18-0905
Retén empuje	18-1233
Retén trasero	18-0520
Junta montaje bomba agua	18-0903
Junta montaje bomba comb	18-0889
Junta tapa distribución	18-0980

* Rotación derecha
 Requiere motor

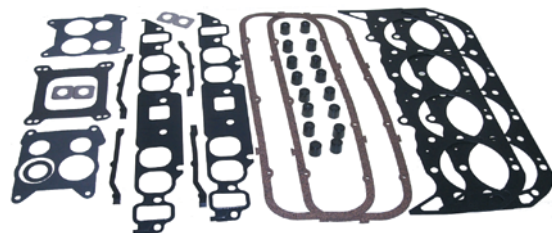

18-1257^②

KIT DE JUNTAS

— CONTIENE —

Descripción	Ref #
Junta culata	18-3877
Junta montaje carb.	NSS
Junta montaje carb.	NSS
Junta montaje carb	NSS
Kit juntas colector admisión	NSS
Junta tapa válvula (2)	NSS
Retenes válvula (16)	NSS
Junta montaje distribuidor	18-0874

① No incluye junta carter

② No incluye juntas colector admisión/escape

NSS No se vende por separado

CHEVY V-8 454/7.4L con puertos cuadrados

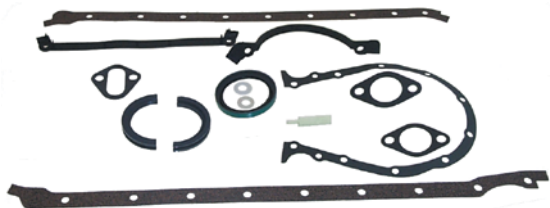

18-1256 *

KIT JUNTAS BLOQUE CORTO

— CONTIENE —

Descripción	Ref #
Junta carter	18-0348
Junta tornillo drenaje aceite	18-0905
Retén empuje	18-1233
Retén trasero	18-0520
Junta montaje bomba agua	18-0903
Junta montaje bomba comb.	18-0889
Junta tapa distribución	18-0980

* Rotación derecha
Requiere motor

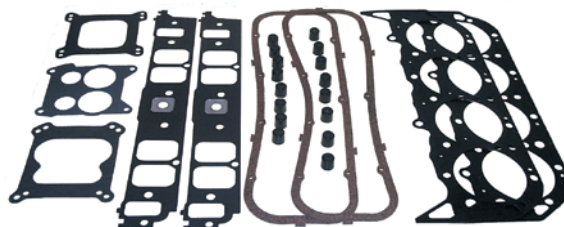

18-1259 ②

KITS JUNTAS CULATA

— CONTIENE —

Descripción	Ref #
Junta culata	18-3877
Junta montaje carb	18-0467
Junta montaje carb	18-0463
Junta montaje carb	18-0462
Juego juntas colector admisión	18-1231
Junta tapa válvula (2)	18-0464
Retenes válvula (16)	18-4024
Junta montaje distribuidor	18-0874

CHEVY V-8 454/7.4L GEN V
CHEVY V-8 454/7.4L GEN V (CON SALIDAS CUADRADAS)
CHEVY V-8 502/8.2L GEN V

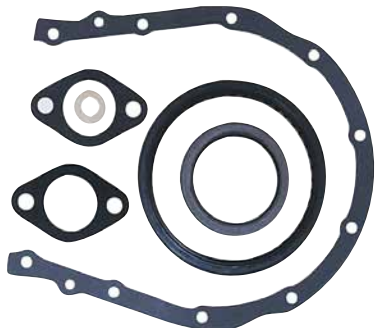

18-1261 ①

KIT JUNTAS CADENAS DISTR.

— CONTIENE —

Descripción	Ref #
Junta tornillo drenaje aceite	18-0905
Retenes empuje	18-1233
Retenes traseros	18-1234
Junta montaje bomba agua	18-0903
Junta tapa distribuidor	18-0468



18-1258 ②

KITS JUNTA CULATA

— CONTIENE —

Descripción	Ref #
Junta culata	18-3874
Junta montaje carb.	18-0467
Junta montaje carb.	18-0463
Junta montaje carb.	18-0462
Kit juntas colector admisión	NSS
Retenes válvula (16)	NSS
Junta montaje distribuidor	18-0874

CHEVY V-8 502/8.2L

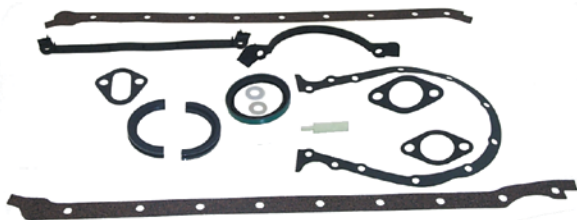

18-1256 *

JUEGO JUNTAS BLOQUE CORTO

— CONTIENE —

Descripción	Ref #
Junta carter	18-0348
Junta tornillo drenaje aceite	18-0905
Retén empuje	18-1233
Retén trasero	18-0520
Junta montaje bomba agua	18-0903
Junta montaje bomba comb.	18-0889
Junta tapa distribución	18-0980

* Rotación derecha
Requiere motor

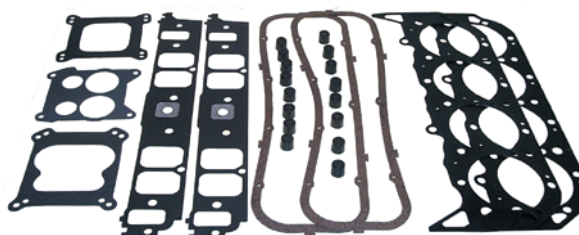

18-1259 ②

JUEGO JUNTA CULATA

— CONTIENE —

Descripción	Ref #
Junta culata	18-3873
Junta montaje carb.	18-0467
Junta montaje carb.	18-0463
Junta montaje carb.	18-0462
Juego juntas colector admisión	18-1231
Junta tapa válvula (2)	18-0464
Retenes válvula (16)	18-4024
Junta montaje distribuidor	18-0874

① No incluye junta carter

② No incluye juntas colector admisión/escape

NSS No se vende por separado

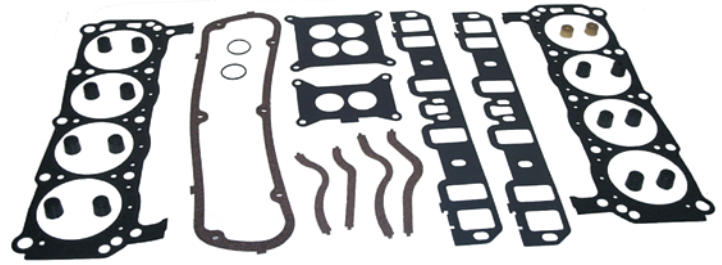

18-1273 ②

JUEGO JUNTA CULATA
— CONTIENE —

Descripción	Ref #
Junta culata (2)	18-3883
Junta montaje carb. 4BBL	18-0357
Junta montaje carb. 2BBL	18-0360
Kits juntas colector admisión	18-0410
Junta tapa válvula (2)	18-0352
Retenes válvula (16)	18-4023

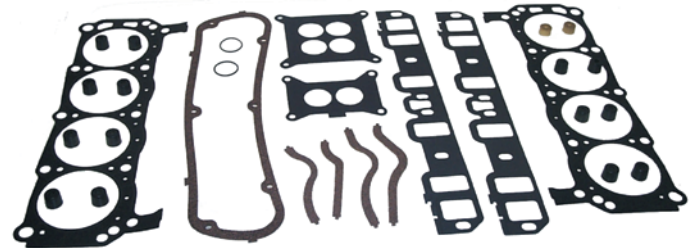

18-1273 ②

JUEGO JUNTA CULATA
— CONTIENE —

Descripción	Ref #
Junta culata (2)	18-3883
Junta montaje carb. 4BBL	18-0357
Junta montaje carb. 2BBL	18-0360
Kits juntas colector admisión	18-0410
Junta tapa válvula (2)	18-0352
Retenes válvula (16)	18-4023

① No incluye junta carter

② No incluye juntas colector admisión/escape

NSS No se vende por separado

APLICACIONES KITS DE JUNTAS

Motor/Modelo	Años	Núm.serie	Bloque corto	Kit de juntas
Chevy 153-2.5L	1965-85	3377341-6229717 ⑤ ②	18-1271	18-1274
Chevy 153/2.5L	1986-88	6229718 & Sup ⑤ ②	18-1271	18-1274
Chevy 181/3.0L	1973-84	3332137-6229717 ⑤ ② ⑤	18-1271	18-1274
Chevy 181/3.0L	1985-96	6229718 & Post ⑤ ② ⑤	N/D	18-1274
Chevy 181/3.0LX	1990-97	C856559 & Post ① ⑤ ②	N/D	18-1274
Mercuriser 165/3.7L (4 Cil.)	1987-89	6916779 & Post ⑦ ③	18-1276	18-1277
Mercuriser 170 (4 Cil.)	1985-86	6916779 & Post ③	18-1276	18-1277
Mercuriser 180/3.7L-LX (4 Cil.)	1987-89	6916779 & Post ③	18-1276	18-1277
Mercuriser 190 (4 Cil.)	1985-86	6916779 & Post ③	18-1276	18-1277
Mercuriser 470	1976-82	4208730-6218036 ③	18-1276	18-1277
Mercuriser 470	1983-84	6218037-6916778 ③	18-1276	18-1277
Mercuriser 485	1980-82	5685394-6218036 ③	18-1276	18-1277
Mercuriser 488	1983-84	6170297-6916778 ③	18-1276	18-1277
Chevy 229/3.8L	1983-84	6330183-6919655 ② ⑤	18-1270	18-1275
Chevy L6 250/4.1L	1970-81	2770032-5813433 ⑤	18-1255	18-1264
Chevy 262/4.3L (2Pc. Rm Retén)	1985	6919656-B455459 ⑤	N/D	18-1275
Chevy 262/4.3L (2Pc. Rm Retén)	1986-92	A483581 ① ⑤	18-1270	18-1275

- ① Parte trasera cigüeñal de una sola pieza.
- ② Modelos 3.8L requiere 18-1211 Retén trasero cigüeñal y 18-0362 Junta carter
- ③ Modelos starboard dip stick requieren 18-0411 Kit juntas carter
- ④ Juego de 4 piezas
- ⑤ Incluye juntas de culata y de válvula

- ⑦ Juntas colector escape/admisión incluidas en el kit
- ⑧ Se requiere cigüeñal trasero principal
- ① Se requiere juntas cigüeñal
- ② Modelos varilla de empuje requieren 18-0328
- ③ Kit bloque corto no incluye juntas cigüeñal
- ④ Use 18-4349 para num. de serie 6218462-B525981
- ⑤ Para modelos con un único retén trasero cigüeñal use 18-1206 kit

APLICACIONES KITS DE JUNTAS

Motor/Modelo	Años	Núm.serie	Bloque corto	Kit de juntas
Chevy 262/4.3L Gen II	1992	D714370-F802999 ① ⑤	18-1270	18-1278
Chevy 262/4.3L Gen II	1993-96	D714370-F802999 ① ⑤	18-1270	18-1278
Chevy 305/5.0L	1977-85	4762210-B525981 ③ ⑤	18-1265	18-1266
Chevy 305/5.0L (Rev. Rota.)	1977-85	4762210-B525981 ③ ⑤	—	18-1266
Chevy 305/5.0L (1 Pc. Rm Retén)	1986	A482027-B525981 ① ⑤	18-1258	18-1266
Chevy 305/5.0L (Rev. Rota.) (1 Pc. Rm Retén)	1986	A482027-B525981 ① ⑤	18-1263	18-1266
Chevy 305/5.0L	1987-95	B525982 & Post ① ⑤ ⑧	18-1268	18-1267
Chevy 305/5.0L Intraborda	1987-95	B522506 & Post ① ⑤ ⑧	18-1268	18-1267
Chevy 305/5.0L (Rev.Rota) intraborda	1987-95	B522506 & Post ① ⑤	18-1263	18-1267
Chevy 350/5.7L	1975-86	4175500-B525982 ③ ⑤ ④	18-1265	18-1266
Chevy 350/5.7 Intraborda	1975-86	4498701-B522506 ③ ⑤	18-1265	18-1266
Chevy 350/5.7 (Rev.Rota) Intraborda	1975-86	4498701-B522506 ③ ⑤	—	18-1266
Chevy 350/5.7L (1Pc. Rm Retén)	1986	6218462-B522506 ① ⑤	18-1268	18-1266
Chevy 350/5.7L (1Pc. Rm Retén) Intraborda	1986	A492879-B522506 ① ⑤	18-1268	18-1266
Chevy 350/5.7L (Rev.Rota)(1 Pc. Rm Retén)	1986	A492879-B522506 ① ⑤	18-1263	18-1266
Chevy 350/5.7L	1987-95	B525982 & Post ① ⑤ ⑧	18-1268	18-1267
Chevy 350/5.7L	1996-97	B525982 & Post ① ⑤ ⑧	18-1268	18-1267
Chevy 350/5.7L Intraborda	1987-95	B522506 & Post ① ⑤	18-1263	18-1267
Chevy 350/5.7L Intraborda	1996-97	B522506 & Post ① ⑤	18-1263	18-1267
Chevy 350/5.7L (Rev.Rota.) Intraborda	1987-95	B522506 & Post ① ⑤	18-1263	18-1267
Chevy 350/5.7L (Rev. Rota.) Intraborda	1996-97	B522506 & Post ① ⑤	18-1263	18-1267
Chevy 454/7.4L	1977-92	4623115-D937001 ⑤	18-1256	18-1257
Chevy 454/7.4L Intraborda	1977-92	4623110 & Post ⑤	18-1256	18-1257
Chevy 454/7.4L (Rev.Rota.) Intraborda	1977-92	4623110 & Post ⑤ ⑧	18-1256	18-1257
Chevy 454/7.4L (Sq. Ports)	1988-91	B721206-D805068 ⑤	18-1256	18-1259
Chevy 454/7.4L Gen V	1992-94	D603118 & post ⑤	18-1261	18-1258
Chevy 454/7.4L Gen V	1995-97	D603118 & Post ⑤	18-1261	18-1258
Chevy 454/7.4L Gen V Intraborda	1992-94	D715494 & Post ⑤	18-1261	18-1258
Chevy 454/7.4L Gen V Intraborda	1995-97	D715494 & Post ⑤	18-1261	18-1258
Chevy 454/7.4L Gen V (Sq. Ports)	1992-94	D805069 & Post ⑤	18-1261	—
Chevy 454/7.4L Gen V (Sq. Ports)	1995-97	D805069 & Post ⑤	18-1261	—
Chevy 502/8.2L	1990-92	C84992-F213244 ⑤	18-1256	18-1259
Chevy 502/8.2L Intraborda	1990-92	C878221-D857199 ⑤	18-1256	18-1259
Chevy 502/8.2L Gen V	1993-97	D824589 & Post ⑤	18-1261	—
Chevy 502/8.2L Gen V Intraborda	1993-97	D857200 & Post ⑤	18-1261	—
Ford 302/5.0L	1971-77	3108723-4887829 ④ ⑤	—	18-1273
Ford 351/5.8L	1975-77	4173000-4902304 ④ ⑤	—	18-1273
Ford 351/5.8L (Rev. Rota.)	1975-77	4173000-4902304 ④ ⑤ ①	—	18-1273

- ① Parte trasera de cigüeñal de una sola pieza
 ② Modelos 3.8L requiere 18-1211 Retén trasero cigüeñal y 18-0362 Junta carter
 ③ Modelos varilla aceite requiere 18-0411 kit juntas carter
 ④ Juego 4 piezas carter.
 ⑤ Incluye juntas de culata y de válvula

- ⑦ Junta colector escape/admisión incluidas en el kit
 ⑧ Se requiere cigüeñal trasero principal
 ① Se requiere juntas cigüeñal
 ② Modelos con varilla de empuje requieren 18-0328
 ③ Se necesitan los retenes del cigüeñal.
 ④ Use 18-4349 para los núm. de serie 6218462-B525981
 ⑤ Para modelos con un único retén trasero cigüeñal use 18-1206 kit



18-5982
ALTERNADOR
 Reemplaza: Cummins 216040, 3604234RX
 Para: Cummins Diesel Marine



18-6846
ALTERNADOR
 Reemplaza: Volvo Penta 1502272, 3803270-2, 5001677, 845940, 72021, 872022, 872757, 873635, 873757, 873757-9, 873771



18-6849
ALTERNADOR
 Reemplaza: Yanmar 119773-77200
 Denso 101211-9940
 Para: Motor Yanmar



18-6925
ALTERNADOR
 Reemplaza: Yanmar 128270-77200
 Hitachi LR135-105
 Para: Motor Yanmar Marine 3GM



18-6926
ALTERNADOR
 Reemplaza:
 Yanmar 119836-77200, -2, -3, 129612-77230
 Para: 3TNE84 3 cil diesel, 3TNE88 3 cil diesel, 4TNE84 4cil, 1.995L, 4TNE88 4cil, 2.190L



18-6927
ALTERNADOR
 Reemplaza: Yanmar 128171-77200
 Para: Motores Yanmar GM



18-6928
ALTERNADOR
 Reemplaza: Yanmar 128170-77200, 77201, 77202
 Hitachi LR135-74, 74B
 Para: modelos 3HM, 3HMF



18-6929
ALTERNADOR
 Reemplaza: Yanmar 119573-77200, 77201, 129470-77200
 Hitachi LR180-03A, B, C
 Para: Motor Yanmar LH



18-6952
ALTERNADOR
 Reemplaza: Cummins 214169, 3603853RX, 3920618, 10459244
 Delco 1100077, 93, 1100211, 74, 1105474, 75, 76



18-6953
ALTERNADOR
 Reemplaza: Volvo 3803645, 8602629, 8602710, 14 8676496, 98, 8676499
 Para: Modelos Diesel D3



18-6955
ALTERNADOR
 Reemplaza: Caterpillar 3001117, 10-258
 Prestolite 110-258, 110-258A
 Volvo 849748-9
 Para: modelos Volvo Diesel 6 cilindros



18-6970
ALTERNADOR
 Reemplaza:
 Yanmar 129470-77200
 Para: series 2GM, 3HM & 4JM



18-6971
ALTERNADOR
 Versión de alto amperaje 18-6970 (120A)



18-6870
ARRANQUE
 Reemplaza: Mercury 50-805833, T
 Para: D7.3L D-tronic 260 LD, 300 año 1999



18-6872
ARRANQUE
 12 Volt
 Reemplaza: Volvo 233991, 240501, 837924, 842775, 843511, 847306-8, 881681
 Para: Modelos TAMD, MD, AQD



18-6880
ARRANQUE
 3 Tornillos
 Reemplaza: Yanmar 123500-77010, 124610-77010, -77019 424610-77010
 Hitachi S114-257, 257G, 483, 483A



18-6930
ARRANQUE
 Reemplaza: Yanmar 104211-77010, 77011



18-6931
ARRANQUE
 Reemplaza: Yanmar 119209-77010, 121120-77010, 77011, 77012, 124520-77010, 77011
 Para: Motores 3 TNV-84-T



18-6932
ARRANQUE
 Reemplaza: Yanmar 121370-77010, 129242-77010, 129698-77010
 Para: 2QM, 3JH3, 3JH3E, 3JH3E-YEU, 3QM, 3QM30, 3QM30F, 3QM30H, 4JH3E



18-6934
ARRANQUE
 2 Tornillos
 Reemplaza: Yanmar 129573-77010, 171008-77010
 Hitachi S13-68, 68A, 68C, 86
 Para: Modelo motor 2TR16, 2TR19



18-6935
ARRANQUE
 Reemplaza: Yanmar 119225-77010, 77011, 119226-77010
 Para: 3TN63, 3TN66, 3TN68



18-6936
ARRANQUE
 Reemplaza: Yanmar 114361-77011, 114362-77010, 77011, 114399-77010
 Para: L40S, L60S



18-6937
ARRANQUE
 2 Tornillos
 Reemplaza: Yanmar 128170-77010, 77010D
 Hitachi S114-303, 303A
 Para: GM, GM2, GM3, GM10, GM20/2-20F, GM30, GMF, 1GM, 2GM, 3GM



18-6938
ARRANQUE
 Reemplaza: Yanmar 119773-77010
 Para: Modelos diesel 6LP-DTE, 6LP-STE



18-6939
ARRANQUE
 Reemplaza: Yanmar 121254-77010, 77011, 77012, 77019, 129429-77010, 77011



18-6944
ARRANQUE
 Reemplaza: Bosch 0-001-109-035
 Caterpillar 163-3361
 Perkins 185086600
 Volvo 21323043, 3583555
 Para: 2001-07 D2-55A, B, C, 2003-07 D2-75A, 4 cil 134.2cu in. 2.2L



18-6947
ARRANQUE
 Reemplaza: Mercuriser 50-805991
 Para: 7.3L (BRAVO & MIE) DIESEL NAV 444 V-8 1994-1996



18-6948
ALTERNADOR
 Reemplaza: Mercury 882571
 Para: CMD 1.7 MI 120 I/L4, CMD 1.7 MS 120 I/L4, D1.7L DTI



18-6949
ARRANQUE
 Reemplaza: Mercuriser 50-831001562, 50-831001961
 Para: W04CTA (150 HP) HINO 234 I/L4, W04CTI (210 HP) HINO 234 I/L4



18-6954
ARRANQUE
 Reemplaza: Mercury 50-831001671, 672, 50-831002050, 051, 052
 Para: EH700 (175/220HP) HINO 393 I/L6, HINO Diesel (Ver Mercuriser)



18-6957
ARRANQUE
 Reemplaza: Mercuriser 50-801333980, 50-854178, 50-855507



18-6958
ARRANQUE
 24 Volt
 Reemplaza: Mercury 847308-4, 870998, 881682
 Para: Modelos MD, TMD, TAMD

CATERPILLAR ALTERNADOR/APLICACIÓN ARRANQUE

Modelo	Año	Arranque	Alternador	Amps
D2-55 A, B, C	2001-2007	18-6944	—	—
D2-75 A	2003-2007	18-6944	—	—

CUMMINS ALTERNADOR/APLICACIÓN ARRANQUE

Modelo	Año	Arranque	Alternador	Amps
6BT 5.9L	1985-SUP	18-6947	—	—
6C	TODOS	—	18-6952	65
6L8.9	TODOS	—	18-6952	65
C8.3	TODOS	—	18-6952	65
C8.3G	TODOS	—	18-6952	65
CM556	TODOS	—	18-6952	65
G8.3	TODOS	—	18-6952	65
GTA8.3 CM558	TODOS	—	18-6952	65
ISC CM2150		—	18-6952	65
ISC CM554	TODOS	—	18-6952	65
ISC CM850	TODOS	—	18-6952	65
ISC8.3 CM2250	TODOS	—	18-6952	65
ISL CM2150 SN	TODOS	—	18-6952	65
ISL CM554	TODOS	—	18-6952	65
ISL CM850	TODOS	—	18-6952	65
ISL G CM2250	TODOS	—	18-6952	65
ISL9 CM2250	TODOS	—	18-6952	65
QSC8.3 CM2250	TODOS	—	18-6952	65
QSC8.3 CM554	TODOS	—	18-6952	65
QSC8.3 CM850	TODOS	—	18-6952	65
QSL9 CM2250	TODOS	—	18-6952	65
QSL9 CM554	TODOS	—	18-6952	65
QSL9 CM850	TODOS	—	18-6952	65
QSL9 G CM558	TODOS	—	18-6952	65

MERCURUISER ALTERNADOR/APLICACIONES ARRANQUE

Modelo	Año	Arranque	Alternador	Amps
530D-TA (Bravo & MIE)	1989-1993	18-6957	—	—
636D-TA (Bravo & MIE)	1989-1993	18-6957	—	—
6BTA5.9-M	1989-SUP	18-6947	—	—
7.3L (Bravo & MIE)	1994-1998	18-6947	—	—
D183 Turbo AC (Bravo & MIE)	1990-1993	18-6957	—	—
D2.8L D-Tronic (Bravo & MIE)	1997-1999	18-6957	—	—
D219 Turbo AC (Bravo & MIE)	1990-1993	18-6957	—	—
D254 Turbo AC (Bravo & MIE)	1990-1993	18-6957	—	—
D3.0L Bravo	1994-1997	18-6957	—	—
D3.0L MIE	1994-1995	18-6957	—	—
D3.6L (Bravo & MIE)	1994-1996	18-6957	—	—
D3.6L W Bravo (Export)	1996-SUP	18-6957	—	—
D4.2L (Bravo & MIE)	1994-1995	18-6957	—	—
D4.2L/ 250 D-Tronic	1997-1999	18-6957	—	—
EI 165	2004-2005	18-6957	—	—
EI 200	2004-2005	18-6957	—	—
EI 250	2004-2005	18-6957	—	—
EI 300	2004-2005	18-6957	—	—
ES 165	2004-2005	18-6957	—	—
ES 250	2004-2005	18-6957	—	—
ES300	2004-2005	18-6957	—	—
MI 200	2004-2005	18-6957	—	—
MS 200	2004-2005	18-6957	—	—
WO4CTA HINO 234 (150HP)	1990-1997	18-6949	—	—
WO4CTI HINO 234 (210HP)	1990-1997	18-6949	—	—
WO6DTA HINO 351 (310HP)	1990-1997	18-6949	—	—
WO6DTI HINO 351 (250HP)	1990-1997	18-6949	—	—

APLICACIONES CONTINUAN EN LA SIGUIENTE PÁGINA

VOLVO ALTERNADOR/APLICACIÓN ARRANQUE

Modelo	Año	Arranque	Alternador	Amps	Valeo Ref No.
2001	1983-1993	—	18-5943	50	—
2002, T	1983-1993	18-6839	18-5943	50	—
2003, T	1983-1993	18-6839	18-5943	50	—
AD290	TODOS	—	18-5943	50	—
AD31 A, B, D, L, P, X	1986-2004	—	18-6846	60	—
AD31 A, B, D, L, P, X	1986-2004	—	18-5943	50	—
AD41D	TODOS	—	18-5943	50	—
AQAD30A	1983-1986	—	18-5943	50	A13N259
AQAD30A	1983-1986	—	18-59700	50	A13N234
AQAD31A	1986-1989	—	18-5943	50	A13N259
AQAD31A	1986-1989	—	18-59700	50	A13N234
AQAD40A, B	1980-1986	—	18-5943	50	A13N259 OR A13N1M
AQAD40A, B	1980-1986	—	18-59700	50	—
AQAD41	TODOS	—	18-5943	50	A13N259
AQAD41	TODOS	—	18-59700	50	A13N234
AQAD41A, B, C	1986-1994	—	18-5943	50	A13N259 OR A13N1M
AQAD41A, B, C	1986-1994	—	18-59700	50	A13N234
AQD32A	1969-1977	—	18-5943	50	A13N1M
AQD32A	1969-1977	—	18-59700	50	A13N234
AQD40A, B	1977-1986	—	18-5943	50	A13N259
AQD40A, B	1977-1986	—	18-59700	50	A13N234
AQD41	TODOS	—	18-5943	50	A13N259
AQD41	TODOS	—	18-59700	50	A13N234
AQD41A	1986-1989	—	18-5943	50	A13N259
AQD41A	1986-1989	—	18-59700	50	A13N234
AQD70B, BL, C, CL, D	1971-1982	18-6872	18-6846	55	—
B21	TODOS	—	18-5943	50	A13N2M
B21	TODOS	—	18-59700	50	—
B23	TODOS	—	18-5943	50	A13N2M
B23	TODOS	—	18-59700	50	—
D12-650	2006-2007	—	18-6846	60	—
D12-715	2002-2004	—	18-6846	60	—
D12C	1999-2004	—	18-6846	60	—
D12-MH	2005-2007	—	18-6846	60	—
D2-55A	TODOS	—	18-5939	50	—
D25A	TODOS	—	18-5959	50	—
D30A	TODOS	—	18-5959	50	—
D3-110	2003-2007	—	18-6953	140	—
D3-130	2003-2007	—	18-6953	140	—
D3-160	2003-2007	—	18-6953	140	—
D3-190	2003-2007	—	18-6953	140	—
D41D	TODOS	—	18-5943	50	—
D49A	TODOS	—	18-5959	50	—
D63	TODOS	—	18-5939	50	—
D71, D	TODOS	—	18-5939	50	—
D73	TODOS	—	18-5939	50	—
KAD32P	1996-2005	—	18-6846	60	—
KAD42A, B, P	1991-2001	—	18-5943	50	A13N259
KAD42A, B, P	1991-2001	—	18-59700	50	A13N234
KAMD42A B, P	1991-1997	—	18-5943	50	A13N259
KAMD42A B, P	1991-1997	—	18-59700	50	A13N234
MD100	TODOS	—	18-6846	55	—
MD100A, B	1965-1984	—	18-6846	60	—
MD11	TODOS	—	18-59700	50	A13N234

APLICACIONES CONTINUAN EN LA SIGUIENTE PÁGINA

VOLVO ALTERNADOR/APLICACIÓN ARRANQUE					
Modelo	Año	Arranque	Alternador	Amps	Valeo Ref No.
MD11C	1975-1981	—	18-5943	50	A13N57M OR A13N1M
MD11C	1975-1981	—	18-59700	50	—
MD120	TODOS	—	18-6846	55	—
MD120A	1970-1980	—	18-6846	60	—
MD17	1975-1981	—	18-5943	50	A13N2M
MD17	1975-1981	—	18-59700	50	A13N234
MD17C	1975-1984	—	18-5943	50	A13N2M
MD17C	1975-1984	—	18-59700	50	A13N234
MD17D	1975-1984	—	18-5943	50	A13N147M OR A13N1M
MD17D	1975-1984	—	18-59700	50	A13N234
MD18	TODOS	—	18-5943	50	A13N147M
MD18	TODOS	—	18-59700	50	—
MD21	1968-1979	—	18-5943	50	A13N147M OR A13N1M
MD21	1968-1979	—	18-59700	50	—
MD21A	1968-1979	—	18-5943	50	A13N1M
MD21A	1968-1979	—	18-59700	50	—
MD2B	1964-1975	—	18-5943	50	A13N1M
MD2B	1964-1975	—	18-59700	50	A13N234
MD2BHY	1964-1975	—	18-5943	50	A13N1M
MD2BHY	1964-1975	—	18-59700	50	—
MD30	1983-1986	—	18-5943	50	A13N147M OR A13N1M
MD30	1983-1986	—	18-59700	50	A13N234
MD30A	1983-1986	—	18-5943	50	A13N259
MD30A	1983-1986	—	18-59700	50	A13N234
MD31A	1986-1994	—	18-5943	50	A13N259
MD31A	1986-1994	—	18-59700	50	—
MD32A	1969-1977	—	18-5943	50	A13N1M
MD32A	1969-1977	—	18-59700	50	A13N234
MD3B	1971-1975	—	18-5943	50	A13N1M
MD3B	1971-1975	—	18-59700	50	A13N234
MD40A	1976-1985	—	18-5943	50	A13N259
MD40A	1976-1985	—	18-59700	50	A13N234
MD42A	1970-1979	18-6872	—	—	—
MD5	TODOS	—	18-5943	50	A13N2M OR A13N147M
MD5	TODOS	—	18-59700	50	—
MD5A, B, C	1975-1982	—	18-5943	50	A13N1M
MD5A, B, C	1975-1982	—	18-59700	50	—
MD6A	1971-1976	—	18-5943	35	A13N57M
MD6A	1971-1976	—	18-59700	35	A13N234
MD7	TODOS	—	18-5943	50	A13N147M OR A13N2M
MD7	TODOS	—	18-59700	50	A13N234
MD70B, C	1970-1985	18-6872	—	—	—
MD70B, C	1965-1985	18-6958	18-6846	60	—
MD7A, B	1976-1983	—	18-5943	50	A13N1M OR A13N259
MD7A, B	1976-1983	—	18-59700	50	A13N234
MD11	TODOS	—	18-5943	50	A13N2M
TAMD 120	TODOS	—	18-6955	120	—
TAMD 120 A, B	1973-1982	—	18-6955	175	—
TAMD 162 A, B, C	1988-2001	—	18-6955	175	—
TAMD102 A, D	1991-2000	—	18-6846	60	—
TAMD103A	2000-2004	—	18-6846	60	—
TAMD120	TODOS	—	18-6846	55	—
TAMD120A, B	1972-1983	18-6958	18-6846	60	—
TAMD121 C, D	1983-1988	18-6958	18-6846	60	—

APLICACIONES CONTINUAN EN LA SIGUIENTE PÁGINA

VOLVO ALTERNADOR/APLICACIÓN ARRANQUE

Modelo	Año	Arranque	Alternador	Amps	Valeo Ref No.
TAMD121 C, D	1983-1988	18-6958	18-6846	55	—
TAMD122 A, C, D, P	1988-2002	18-6958	18-6846	60	—
TAMD162 A, B, C	1988-2001	—	18-6846	60	—
TAMD163 A, P	1994-2001	—	18-6846	60	—
TAMD163 A, P	1994-2001	—	18-6846	55	—
TAMD165A, C, P	2002-2005	—	18-6846	60	—
TAMD30, A, B, C	1983-1986	—	18-5943	50	A13N1M
TAMD30, A, B, C	1983-1986	—	18-59700	50	A13N234
TAMD31A, B, D, L, M, P, S, X	1985-2004	—	18-5943	50	A13N259
TAMD31A, B, D, L, M, P, S, X	1985-2004	—	18-59700	50	A13N234
TAMD31A, B, D, L, M, P, S, X	1985-2004	—	18-6846	60	—
TAMD40A, B, C	1979-1986	—	18-5943	50	A13N259
TAMD40A, B, C	1979-1986	—	18-59700	50	A13C234
TAMD41A	1986-1989	—	18-5943	50	A13N259 OR A13N1M
TAMD41A	1986-1989	—	18-59700	50	A13N234
TAMD60 A, B, C	1976-1987	18-6872	18-6846	60	—
TAMD61A	1986-1995	18-6872	18-6846	60	—
TAMD62A	1992-1994	18-6872	18-6846	60	—
TAMD63L, P	1994-2005	18-6872	—	—	—
TAMD70	TODOS	—	18-5943	50	A13N259
TAMD70	TODOS	—	18-59700	50	—
TAMD70	TODOS	—	18-6846	55	—
TAMD70B, C, D	1970-1987	18-6872	18-6846	60	—
TAMD70E	1983-1987	—	18-5943	50	A13N1M
TAMD70E	1983-1987	18-6872	18-59700	50	—
TAMD70E	1983-1987	18-6872	18-6846	60	—
TAMD71A, B	1986-2000	18-6872	18-6846	60	—
TAMD72A, P, W, J	1991-1997	18-6872	18-6846	60	—
TAMD73P, W, J	1997-1999	18-6872	18-6846	60	—
TAMD74A, C, L, P	1998-2005	18-6872	18-6846	60	—
TAMD75P	1998-2005	18-6872	18-6846	60	—
THAMD70B, C	1972-1979	18-6872	18-6846	60	—
TMD 100	TODOS	—	18-6955	120	—
TMD 100 B, C	1965-1988	—	18-6955	175	—
TMD100A	TODOS	—	18-6846	55	—
TMD100B, C	1965-1988	—	18-6846	60	—
TMD102A	1988-2000	—	18-6846	60	—
TMD120	TODOS	—	18-6955	120	—
TMD120 A,B	1970-1984	18-6958	18-6955	175	—
TMD120A, B	1970-1984	18-6958	18-6846	60	—
TMD121C	1983-1988	18-6958	18-6846	60	—
TMD122A	1988-2000	18-6958	18-6846	60	—
TMD122A	1988-2000	18-6958	18-6846	55	—
TMD30A, B	1983-1986	—	18-5943	50	A13N147M
TMD30A, B	1983-1986	—	18-59700	50	A13N234
TMD31A, B, D, L	1986-1997	—	18-5943	50	A13N259
TMD31A, B, D, L	1986-1997	—	18-59700	50	A13N234
TMD40	TODOS	—	18-5943	50	A13N147M
TMD40	TODOS	—	18-59700	50	A13N1M
TMD40A, B, C	1976-1986	—	18-5943	50	A13N259
TMD40A, B, C	1976-1986	—	18-59700	50	A13N234
TMD41A, B, D, L	1986-1997	—	18-5943	50	A13N259
TMD41A, B, D, L	1986-1997	—	18-59700	50	A13N234
TMD70B, C	1972-1985	18-6872	18-6846	60	—

APLICACIONES CONTINUAN EN LA SIGUIENTE PÁGINA

YANMAR ALTERNADOR/APLICACIÓN ARRANQUE

Modelo	Año	Arranque	Alternador	Amps
1GM	1980-1984	18-6937	18-6925 ⑥	35
1GM	1980-1984	18-6937	18-6928 ③ ⑦ ⑧	35
1GM10	1980-1981	18-6937	18-6928	35
1GM10	1982-SUP	18-6937	18-6925 ④	35
1GM10	1982-SUP	18-6937	18-6927 ⑤	35
1GM10C	1982-1984	18-6937	18-6925	35
1GM10L	1982-SUP	—	18-6927 ⑤	35
1GM10L	1982-SUP	—	18-6925 ④	35
1GM10VE	1985-SUP	—	18-6927	35
1GML	1982-SUP	—	18-6927	35
1GML	1982-SUP	—	18-6925	35
1GMY	1982-SUP	—	18-6925 ④	35
1GMY	1982-SUP	—	18-6927 ⑤	35
2GM	1980-1984	18-6937	18-6925 ⑥	35
2GM	1980-1984	18-6937	18-6928 ③ ⑦ ⑧	35
2GM20	1982-SUP	18-6937	18-6925	35
2GMF	1980-1984	18-6937	18-6925 ⑥	35
2GMF	1980-1984	—	18-6928 ③ ⑦ ⑧	35
2GMFL	TODOS	—	18-6925	35
2GMFY(E)-E	TODOS	—	18-6925	35
2GML	TODOS	—	18-6925	35
2GMYE-EC	TODOS	—	18-6925	35
2GMZ	TODOS	—	18-6925	35
2QM15	1977-1980	—	18-6925 ⑥	35
2QM15	1977-1980	—	18-6928 ③ ⑦ ⑧	35
2QM20	1975-1980	—	18-6928	35
2TD	1982-SUP	—	18-6925	35
2TM	1982-SUP	—	18-6925	35
3GM	1980-1984	18-6937	18-6925	35
3GM	1980-1984	18-6937	18-6928 ③ ⑦ ⑧	35
3GMD	1982-SUP	18-6937	18-6925 ⑥	35
3GMD	1982-SUP	18-6937	18-6928 ③ ⑦ ⑧	35
3GMF	1982-SUP	18-6937	18-6925 ⑥	35
3GMF	1982-SUP	18-6937	18-6928 ③ ⑦ ⑧	35
3GMFY-E	1982-SUP	—	18-6925	35
3GMLE	1982-SUP	—	18-6927	35
3HM	1980-1984	—	18-6925 ⑥	35
3HM	1980-1984	—	18-6928 ③ ⑦ ⑧	35
3HMF	1980-1984	—	18-6925 ⑥	35
3HMF	1980-1984	—	18-6925 ③ ⑦ ⑧	35
3JH2	1991-1999	18-6880	18-6925	35
3JH2	1991-1999	18-6880	18-6929	80
3JH2BE	1991-1999	18-6880	18-6929	80
3JH2E	1991-1999	18-6880	18-6929	80
3JH3	1999-2003	—	18-6925	35
3JH3	1999-2003	—	18-6929	80
3JH3E	TODOS	—	18-6929	80
3JH3E-YEU	TODOS	18-6880	—	—
3JH3Z	TODOS	—	18-6925	35
3JH4E	2003-SUP	—	18-6929	80
3TM20	2004-SUP	—	18-6929	80

① Hitachi S114-303 ② Hitachi S114-483A ③ Hitachi LR135-105 ④ Hitachi LR135-126 ⑤ Hitachi LR135-74B ⑥ S/N 3690-inferior
 ⑦ S/N 3691-sup ⑧ Con 2 Pin conexión regulada ⑨ Sin 2 Pin conexión regulada ⑩ Sin tapa plástico

APLICACIONES CONTINUAN EN LA SIGUIENTE PÁGINA

YANMAR ALTERNADOR/APLICACIÓN ARRANQUE

Modelo	Año	Arranque	Alternador	Amps
3YM30	2004-SUP	—	18-6929	80
3TN63	1990-SUP	18-6935	—	—
3TN66	1985-SUP	18-6935	—	—
3TN68	1995-SUP	18-6935	—	—
3TNE84	1982-SUP	18-6880	18-6926	40
3TNE88	1982-SUP	18-6880	18-6926	40
3TNV-84-T	TODOS	18-6931	—	—
4GM	1985-SUP	—	18-6925	35
4JH	1982-SUP	18-6880	18-6925	35
4JH2-CE	1988-SUP	18-6880	18-6929	80
4JH2-DTE	1988-SUP	18-6880	18-6929	80
4JH2-E	1988-SUP	18-6880	18-6929	80
4JH2-HTE	1988-SUP	18-6880	18-6929	80
4JH2L-HTNE	1988-SUP	18-6880	18-6925	35
4JH2L-TNE	1988-SUP	18-6880	18-6925	35
4JH2-TE	1988-SUP	18-6880	18-6929	80
4JH2-UTE	1988-SUP	18-6880	18-6925	35
4JH3-CE	1994-2003	18-6880	18-6929	80
4JH3-DTE	1994-2003	18-6880	18-6929	80
4JH3E	1994-2003	18-6880	18-6929	80
4JH3-HTE	1994-2003	18-6880	18-6929	80
4JH3-TCE	1994-2003	18-6880	18-6929	80
4JH3-TE	1994-2003	18-6880	18-6929	80
4JH3-TE-YEU	1994-2003	18-6880	—	—
4JH3ZA	1994-2003	18-6880	18-6925	35
4JHE	TODOS	—	18-6929	80
4JH-HT	1982-SUP	—	18-6925	35
4JH-HT-Z	1982-SUP	18-6880	18-6925	35
4JH-T	1982-SUP	18-6880	18-6925	35
4JH-TE	1982-SUP	—	18-6929	80
4JH-TZ	1982-SUP	18-6880	18-6925	35
4JHZ	TODOS	18-6880	18-6925	35
4LHA-DTE	TODOS	18-6939	18-6929	80
4LHA-DTZ	TODOS	18-6939	18-6929	80
4LHA-HTE	TODOS	18-6939	18-6929	80
4LHA-HTZE	TODOS	18-6939	18-6929	80
4LHA-STE	TODOS	18-6939	18-6929	80
4LHA-STZE	TODOS	18-6939	18-6929	80
4LH-DTE	1987-SUP	18-6939	18-6929	80
4LH-HTE	1987-SUP	18-6939	18-6929	80
4LH-STE	1987-SUP	18-6939	18-6929	80
4LH-TE	TODOS	18-6939	18-6929	80
4TD	1982-SUP	—	18-6925	35
4TM	1982-SUP	—	18-6925	35
4TNE84	1989-SUP	18-6880	18-6926	40
4TNE88	1989-SUP	18-6880	18-6926	40
6LP-DT	1997-SUP	—	18-6849	80
6LP-DTE	1997-SUP	18-6938	18-6849	80
6LP-DTZE	1997-SUP	—	18-6849	80
6LP-DTZE1	1997-SUP	—	18-6849	80
6LP-DTZY	1997-SUP	—	18-6849	80

① Hitachi S114-303 ② Hitachi S114-483A ③ Hitachi LR135-105 ④ Hitachi LR135-126 ⑤ Hitachi LR135-74B ⑥ S/N 3690-inferior
 ⑦ S/N 3691-sup ⑧ con 2 Pin conexión regulada ⑨ sin 2 Pin conexión regulada ⑩ Sin tapa de plástico

APLICACIONES CONTINUAN EN LA SIGUIENTE PÁGINA

YANMAR ALTERNADOR/APLICACIÓN ARRANQUE

Modelo	Año	Arranque	Alternador	Amps
6LP-ST	1997-SUP	—	18-6849	80
6LP-STE	1997-SUP	18-6938	18-6849	80
6LP-STZE	1997-SUP	—	18-6849	80
6LY2-STE	1992-SUP	18-6934	18-6929	80
6LYA-STE	1992-SUP	18-6934	18-6929	80
6LYA-UTE	1992-SUP	18-6934	18-6929	80
6LYM-STE	1992-SUP	18-6934	18-6929	80
6LYM-UTE	1992-SUP	18-6934	18-6929	80
6LY-ST	1992-SUP	18-6934	18-6929	80
6LY-STE	1992-SUP	18-6934	18-6929	80
6LY-STM	1992-SUP	18-6934	18-6929	80
6LY-STZY	1992-SUP	18-6934	18-6929	80
6LY-UT	1992-SUP	18-6934	18-6929	80
6LY-UTE	1992-SUP	18-6934	18-6929	80
6LY-UTM	1992-SUP	18-6934	18-6929	80
6LY-UTZY	1992-SUP	18-6934	18-6929	80
KBW-20	TODOS	—	18-6929	80
KBW-21	TODOS	—	18-6929	80
6PH	1982-SUP	18-6934	—	—
6PH-HTZY	1982-SUP	18-6934	—	—
6PH-M-HTE	1982-SUP	18-6934	—	—
6PHM-HTZ	1982-SUP	18-6934	—	—
6PHM-TZ	1982-SUP	18-6934	—	—
6PHS-HTPS	1982-SUP	18-6934	—	—
6PHS-TPS	1982-SUP	18-6934	—	—
KM2A	TODOS	18-6937	18-6925 ①	35
KM2A	TODOS	18-6937	18-6927 ②	35
KM2C	TODOS	18-6937	—	—
KM2P	TODOS	18-6937	18-6925 ①	35
KM2P	TODOS	18-6937	18-6927 ②	35
KM3A	TODOS	18-6937 ①	18-6929	80
KM3A	TODOS	18-6880 ②	18-6929	80
KM3P	TODOS	18-6937	—	—
KM3V	TODOS	18-6937	18-6925 ①	35
KM3V	TODOS	18-6937	18-6927 ②	35
KM5A	TODOS	18-6939	18-6929	80
L40S	1984-1999	18-6936	—	—
L60S	1984-1999	18-6936	—	—
SB12	1976-1980	18-6930	—	—
SB8	1976-1980	18-6930	—	—
SVE12	1974-1976	18-6930	—	—
SVE8	1974-1976	18-6930	—	—
UJH2E	TODOS	18-6880	18-6929	80
Y-5M	TODOS	—	18-6925 ①	35
Y-5M	TODOS	—	18-6927 ②	35
YC	1971-SUP	18-6930	—	—
YSB12	1976-1977	18-6930	—	—
YSB8	1976-1977	18-6930	—	—
YSE12	1974-1976	18-6930	—	—
YSE8	1974-1976	18-6930	—	—
YSM12	1977-1980	18-6930	—	—
YSM8	1977-1980	18-6930	—	—

① Hitachi S114-303 ② Hitachi S114-483A ③ Hitachi LR135-105 ④ Hitachi LR135-126 ⑤ Hitachi LR135-74B ⑥ S/N 3690-inferior
 ⑦ S/N 3691-sup ⑧ Con 2 Pin conexión regulada ⑨ Sin 2 Pin conexión regulada ⑩ Sin plástico tapa

DIESEL FILTRO COMBUSTIBLE

20 MICRONES



18-7931

Reemplaza:

Detroit Diesel 5574508
8V-92, 8V-71

20 MICRONES



18-7934

Reemplaza:

Cerlist Diesel 1512904
Modelo M

20 MICRONES



18-7935

Reemplaza:

Fram CCS 1136
Fram FCS 1136 soporte filtro

20 MICRONES



18-7942

Reemplaza:

Volvo 466987, 3825133
Para: MD100A, TMD100A, MD100B, MD120A, TMD120A, TAMD120A, MD120B, TMD120B, TAMD120B, MD70B, TMD70B, TAMD70B, THAM-D70B, AQAD70B, MD70C, TMD70C, TAMD70C, AQD70C, TAMD60A, TAMD60B, TAMD60C, D5/D7 MARINE GENSET, D5A-T, D5A-TA, D7A-T, D7A-TA, D7C-TA, D63 MARINE, D71/73 MARINE, KAD32P, TAMD42WJ, KAD43P/44P/300, KAMD43P/44P/300, TAMD103A, TAMD61A, TAMD62A, TAMD71A, TAMD72A, TAMD72P, TAMD72WJ, TAMD74, TAMD75 MARINE, TMD102A, TAMD102A, TAMD102D, TMD122A, TAMD122A, TAMD122P, TMD31L, TAMD31P/L/M/S, AD31P/L, TMD41L, TAMD41P/L/M/H

20 MICRON



18-7970

Reemplaza:

Cerlist Diesel 1512903
Modelo 3M



18-79960

ELEMENTO FILTRO COMBUSTIBLE

Reemplaza: Yanmar 104500-55710

Para: Todas series GM, series YM, HM Series, QM Series

20 MICRON



18-7858

Reemplaza: Volvo 858201

Para: CAV Tipo unidad
Para: AQ120B, 125A, B, 131A, 140A, 145A, B, 151, BB, 140, 145A



18-7873

Reemplaza:

MerCruiser 35-808275
Para modelos: D7.3/270 Bravo & MIE Diesel (1994-96)



18-8124

Reemplaza: Volvo 829913

Para: 2001, 2001B, 2002, 2002B, 2003, 2003B/T/TB, AQD2B, MD11C/D, MD17C/D, MD1B, MD2B, MD3B, MD5A/B/C, MD7/B

18-8125

Reemplaza: Volvo 3583443

Para: D4-180i-B, D4-180i-C, D4-210A-A, D4-210A-B, D4-210i-A, D4-210i-B, D4-225A-B, D4-225A-C, D4-225i-B, D4-225i-C, D4-260A-A, D4-260A-B, D4-260A-C, D4-260D-B, D4-260D-C, D4-260i-A, D4-260i-B, D4-260i-C, D4-300A-A, D4-300A-C, D4-300D-A, D4-300D-C, D4-300i-A, D4-300i-C, D6-280A-A, D6-280A-B, D6-280i-A, D6-280i-B, D6-310A-A, D6-310A-B, D6-310D-A, D6-310D-B, D6-310i-A, D6-310i-B, D6-330A-B, D6-330A-C, D6-330D-B, D6-330D-C, D6-330i-B, D6-330i-C, D6-350A-A, D6-350A-B, D6-370A-B, D6-370A-C, D6-370D-A, D6-370D-B, D6-370D-C, D6-370i-A, D6-370i-B, D6-370i-C, D6-435D-A, D6-435D-C, D6-435i-A, D6-435i-C



18-8126

Reemplaza: Volvo 861477

Para: D1-13 A, D1-13 B, D1-20 A, D1-20 B, D1-30 A, D1-30 B, D2-40 A, D2-40 B, D2-55 A, D2-55 B, D2-55 C, D2-55 D, D2-55 E, D2-55F, D2-75 A, D2-75 B, D2-75 C, D2-75F, MD2010A, MD2010B, MD2020A, MD2020B, MD2030A, MD2030B, MD2040A, MD2040B



18-35443

BOMBA COMBUSTIBLE

Reemplaza: Volvo 3582310

Para: Motores diesel Volvo D30, D40, D31, D41, D42



18-35444

BOMBA COMBUSTIBLE

Reemplaza: Volvo 858459

Para: Motores diesel Volvo antiguos D21 y D32

Filtro Aceite

Tipo motor	Ref. Filtro
1GM 1 GM 10	11930535151
2 GM/ 2 GM 20/ 2 GM 20F	11930535151
3 GM/ 3 GM 30/ 3 GM 30F	11930535151
2QM 15	11930535151
2QM 20	11930535151
3QM 30	11930535151
3 HM	11930535151
3 HM 35	11930535151
3YM20/C	11930535151
3YM30/C	11930535151
3 JH2-E/BE	11930535151
3 JH2-CE/TCE	11930535151
3 JH2-TE / TBE	11930535151
3JH3-E / TCE	11930535151
3JH4 E/ CE	11930535151
4 JH E /TE /HTE /DTE	11966035150
4 JH2E /TE /HTE/ DTE/ UTE	11966035150
4 JH3 CE	11966035150
4 JH3-E-YEU	11966035150
4 JH3-TE-YEU	11966035150
4 JH3- HTE -YEU	11966035150
4 JH3-DTE-YEU	11966035150
4 JH4-E / CE	11966035150
4 JH4-TE /HTE	11966035150
4BY150/180	NO
4 LH - TE/HTE	11900535151
4 LH DTE/STE	12769535150
4 LHA-DTE /STE	12769535150
4 LHA-DTP /STP	12769535150
6 CX GTE / GTE2	12769535150
6BY220 /260	16500069590
6 LP-DTE /STE	11977090620
6 LPA-DTE / STE	11977090620
6 LPA-DTP / STP	11977090620
6 LY-UTE /STE /6LYA-STE	11959335100
6 LYA-STP / 6 LY2A-STE	11959335100
6 LY2A-STE /STP	11959335400

Filtro Gasoil

Tipo motor	Ref. Filtro
YSB 8/ YSB 12	10450055710
YSM 8 /YSM 12	10450055710
YSE 8 /YSE 12	10450055710
1GM 1 GM 10	10450055710
2 GM/ 2 GM 20/ 2 GM 20F	10450055710
3YM20 /C	10450055710
3 GM/ 3 GM 30/ 3 GM 30F	10450055710
2QM 15	10450055710
2QM 20	10450055710
3QM 30	10450055710
3 HM	10450055710
3YM30 /C	10450055710
3 HM 35	10450055710
3 JH2-E/BE	12947055703
3 JH2-CE/TCE	12947055703
3 JH2-TE / TBE	12947055703
3JH3-E/ TCE	12947055703
3JH4-E/ CE	12947055703
4 JH E/ TE/ HTE/ DTE	12947055703
4 JH2E /TE HTE/ DTE	12947055703
4 JH3 CE	12947055703
4 JH3-E-YEU	12947055703
4 JH3-DTE-YEU	12947055703
4 JH4E	12947055703
4 JH2 UTE	12957455711
4 JH3-TE-YEU	12957455711
4 JH3-HTE-YEU	12957455711
4 JH4-TE /HTE	12957455711
4BY150 /180 6BY220 /260	12065055040
4BY150 /180 6BY220 /260	12065055020
4 LH-TYE /HTE /HTTP	12185755710
4 LH DTE/STE	41650502320
4 LHA-DTE /STE	41650502320
4 LHA-DTP /STP	41650502320
6 LP-DTE /STE	11977355510
6 LPA-DTE /DTP /STE /STP	11977355510
6 LY-UTE /STE /STP	41650502330
6 LY-STE / STP	41650502330

TURBOS PARA MOTORES VOLVO

MODELO MOTOR	REFERENCIA ORIGINAL	REFERENCIA PRONAUTIC	JUNTA
KAD 32 P	3581528	VOL6016	VOL3582676
KAD SERIES	3802082	VOL6094	VOL3582676
KAD 300, TAMD 41, KAMD 43/52	838679	VOL6497	VOL3582676
KAD 44	838695	VOL6496	VOL3582676
MD 40, TMD40, TAMD40, AQD40	3802033	VOL6492	VOL3582676
PERKINS	4667705008 S	VOL6770	VOL3582676
KAD 300	3583006	VOL7200	VOL3582676

TURBOS PARA MOTORES YANMAR

MODELO MOTOR	REFERENCIA YANMAR	REFERENCIA PRONAUTIC	JUNTA
4LH-STE	119195-18030	119195-18030	12830013230
4LH-STH	119195-18031	YANMYAV	12830013230
4LH-DTE	119173-18010, 119171-18010, 119173-18011	VOL6292	12830013230
4LHA-DTP	119175-18041	YANMYDH	12830013230
4LHA-STP	119175-18031, 118175-18031	YANMYDA	12830013230
4LHA-HTE	119172-18030	YANMYDN	12830013230
4JH3-T	129671-18001	YANMYCZ	12830013230
4LH-TE	119171-18010	YANMY58	12830013230
4JH-DTE	129473-18000	YANMY34	12830013230

TURBOS YANMAR



TURBOS VOLVO



18-7783
JUEGO JUNTAS BOMBA
COMBUSTIBLE

Reemplaza: Volvo 273663
Para: D30, D31, D32, D40, D42, D44, AD30A, AQAD30A, TAMD30A, TMD30A, AD31A, AD31B, AD31D, AD31XD, AQAD31A, MD31A, TAMD31A, TAMD31B, TAMD31D, TMD31A, TMD31B, TMD31D, KAD32P-A, AD40B, AQAD40A, AQAD40B, AQD40A, MD40A, TAMD40A, TAMD40B, TMD40A, TMD40B, TMD40C, AD41A, AD41B, AD41D, AQAD41A, D41A, D41B, D41D, TAMD41A, TAMD41B, TAMD41D, TMD41A, TMD41B, TMD41D, KAD42A, KAD42B, KAD42P-A, KAMD42A, KAMD42B, KAMD42P-A, TAMD42B, TAMD42WJ-A, KAD43P-A, KAMD43P-A, KAD44P-A, KAMD44P-A



18-57703
FILTRO AIRE

Reemplaza:
Yanmar 128270-12540
Para: Yanmar 2GM & 3GM30



18-57704
FILTRO AIRE

Reemplaza:
Yanmar 128171-12540
Para: Yanmar 1GM10



18-8950
IMPULSOR

Reemplaza:
Yanmar 124223-42092
Para: 2GM20F, 2GMF, 2QM, 2QM20, 3GM30F, 3GMF, 3HM, 3HM35, 3HM35F, 3HMF, 3QM30, 3QM30F



18-8951
IMPULSOR

Reemplaza:
Yanmar 128176-42071
Para: 1GM, 1GM10



18-8952
IMPULSOR

Reemplaza:
Yanmar 104211-42071
Para: 2GM, 3GM



18-45714
IMPULSOR F75B

Reemplaza:
Yanmar 119574-42550,
119574-42552
Para: bomba F75B



18-55500
JUNTA CULATA

Reemplaza:
Yanmar 728170-92600
Para: 1GM (7hp)



18-55501
JUNTA CULATA

Reemplaza: Yanmar 18-55501
Para: 1GM10 (9hp)

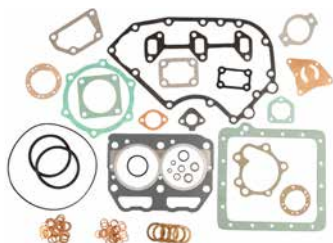

18-55502
JUNTA CULATA

Reemplaza:
Yanmar 728271-92605
Para: 2GM20 (18hp), 2GM20B, 2GM20C,
2GM20F (18hp)



18-55503
JUNTA CULATA

Reemplaza:
Yanmar 728374-92605
Para: 3GM30 (27hp), 3GM30 EU (27hp),
3GM30F (27hp), 3GM30F EU (27hp)



18-56000
JUNTA TAPA BONNET

Reemplaza:
Yanmar 128170-11310
Para: 1GM, 1GM10



18-56601
JUNTA TERMOSTATO

Reemplaza:
Yanmar 104211-49160
Para: 1GM, 1GM10



18-56602
JUNTA BOMBA AGUA

Reemplaza:
Yanmar 128170-42090
Para: 1GM, 1GM10



18-55600
JUNTA CULATA

Reemplaza:
Yanmar 128170-01331
Para: 1GM (7hp)



18-55601
JUNTA CULATA
Reemplaza:
Yanmar 128171-01911
Para: 1GM10 (9hp)



18-55602
JUNTA CULATA
Reemplaza:
Yanmar 128271-01911
Para: 2GM20 (18hp), 2GM20B,
2GM20C, 2GM20F (18hp)



18-55603
JUNTA CULATA
Reemplaza:
Yanmar 128374-01911
Para: 3GM30 (27hp), 3GM30 EU
(27hp), 3GM30F (27hp), 3GM30F
EU (27hp)



18-6200
ANODO
Reemplaza:
Yanmar 27210-200200
Para: 1GM, 1GM10, 6LY3



18-6201
ANODO
Reemplaza:
Yanmar 27210-200300
Para: 2GM, 3GM, 2GMF, 3GMF,
2GM20, 3GM30, 3HM, 3HM35,
2QM15, 2QM, 3QM, 2QM20,
3QM30, YSB8, YSB12, YSM8,
YSM12

FILTRO ACEITE

Los filtros de aceite SIERRA están fabricados con materiales de alta calidad:

- Capa de epoxy de gran resistencia a la corrosión.
- Recipiente de acero extra-resistente.
- Elemento filtrante de alta eficiencia.
- Cubierta por la garantía Sierra.

DIESEL FILTRO ACEITE



18-0032
Reemplaza:
Volvo 847741



18-0033
Reemplaza:
Volvo 478736



18-0034
Reemplaza:
Volvo 477556



18-0035
Reemplaza:
Volvo 3582732
Caudal completo



18-0036
Reemplaza:
Volvo 3582733
Bypass



18-7871
Reemplaza:
Mercruiser 35-805809

DIESEL FILTRO ACEITE (Cont.)

 <p>18-7880 Reemplaza: Caterpillar 1R-0658 Volvo-Penta 466634</p>	 <p>*18-7884 Reemplaza: Universal 299381 Volvo-Penta 834337 Rosca Espec: 3/4" x 16NPT</p>	 <p>*18-7886 Reemplaza: Perkins 2654403 Rosca Espec: 3/4" x 16NPT</p>
 <p>*18-7910-1 Reemplaza: Westerbeke 30220 Yanmar 124450-35100, 119350-35150, 119350-35151 Rosca Espec: 20mm x 1.5</p>	 <p>*18-7917 Reemplaza: Yanmar 124450-35110, 124550-35110, 171056-35110, 171056-35111, 124085-35113 Rosca Espec: 20mm x 1.5</p>	 <p>*18-7925 Reemplaza: Westerbeke 21235 Rosca Espec: 3/4" x 16NPT</p>
 <p>*18-7926 Reemplaza: Volvo 423135, 4785974 Rosca Espec: 1" x 12NPT</p>	 <p>18-7927 Reemplaza: Caterpillar 1R-0714 Rosca Espec: 1 1/8" x 16NPT</p>	

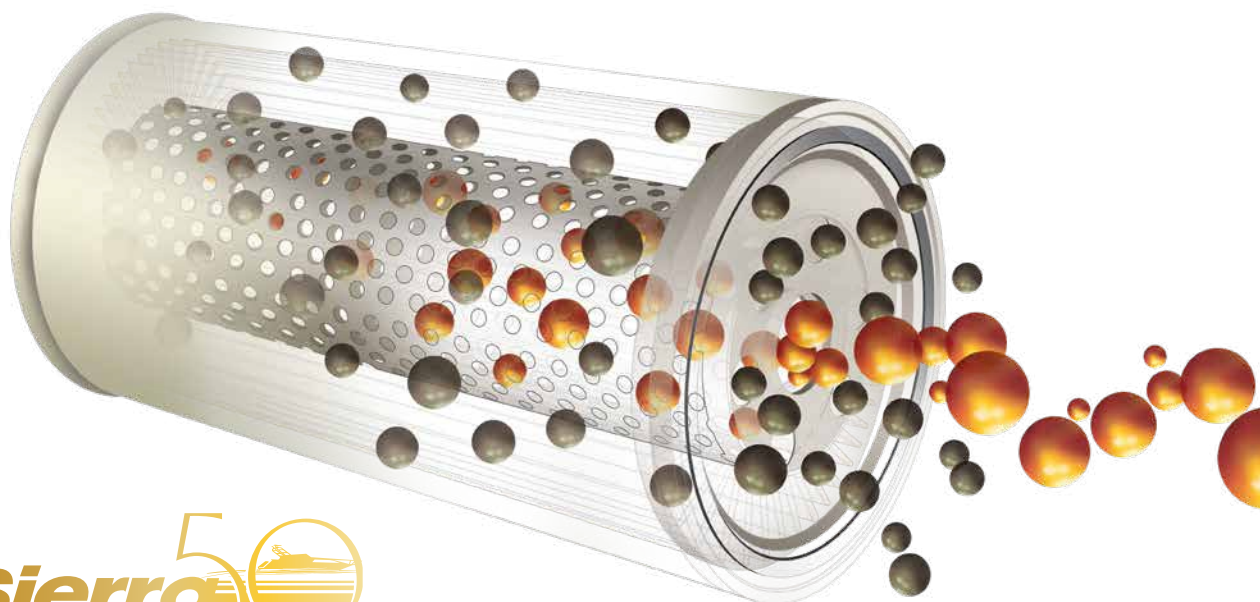

* Anti-Drenaje-Válvula de retroceso
 Elimina los arranques en seco, la válvula evita que el aceite vuelva al cárter durante el apagado del motor.

SEA RAY		
MODELO NO.	S/N	AÑO
3.0L	B787205-B917529	1988
4.3L	B785483-B921276	1988
4.3LX	B785981-B922330	1988
5.7L	B784799-B917017	1988
SRX5.7L, 350 Mag	B785241-B919012	1988
SRX7.4L, 454 Mag Alpha	B785149-B924857	1988
SRX7.4L-H, 454 Mag Bravo	B721206-B919343	1988

COLAS		
MODELO NO.	S/N	AÑO
SRX7.4L, Alpha	B803866-C348032	1988
SRX7.4L-H, Bravo	B803872-B999972	1988

MOTORES INTRABORDA		
MODELO NO.	S/N	AÑO
5.7L	B788204-B919356	1988
7.4L	B788179-B913769	1988

RENAULT 4 CILINDROS (COLAS)		
MODELO	S/N	AÑO
60	1887079-2049044	1965-68
80	2049045-2851423	1966-69
90	2851424-3226957	1970-72

GM 4 CILINDROS (COLAS)		
MODELO	S/N	AÑO
110	1537370-2044033	1963-66
120	1666601-3377340	1964-72
120	3377341-3770649	1972-73
120	3770650-4952700	1974-77
120	4952701-5192048	1978
120	5192049-6229717	1979-82
120	6229718-6853913	1983-84
120	6853914-B531853	1985-86
120/2.5L	B531854-C853255	1987-89
140	2508261-6229717	1968-82
140/3.0L	6229718-C856558	1982-89
3.0L/LX	C856559-SUP	1990-SUP

MERCURY MARINE 4 CILINDROS (COLAS)		
MODELO	S/N	AÑO
470 (2bbl.)	4208730-5520114	1976-79
470 (2bbl.)	5520115-6218036	1980-82
470 (2bbl.)	6218037-6916778	1983-84
170 (2bbl.)	6916779-SUP	1985-86
165/3.7L (2bbl.)	6916779-SUP	1987-89
485 (2bbl.)	5685394-6218036	1980-82
488 (4bbl.)	6170297-6916778	1983-84
190 (4bbl.)	6916779-SUP	1985-86
180/3.7LX (4bbl.)	6916779-SUP	1987-89

GM EN LÍNEA 6 CILINDRO (COLAS)		
MODELO	S/N	AÑO
140	1538930-1725960	1963
150	1666495-2048046	1964-66
160	2048022-2770031	1967-69
165	2770032-5178958	1970-78
165	5178959-5813433	1979-81
200	2453769-2712072	1969

GM V6 (COLAS)		
MODELO	S/N	AÑO
185 (4bbl.)	6330183-6919655	1983-84
185 (2bbl.)	A331455-B527954	1985-87
175/4.3L (2bbl.)	B527955-D714106	1987-92
4.3L (GEN II)(2bbl.)	D714107-F000877	1992-93
4.3L (GEN II)(2bbl.)	F000878-F601126	1993-95
4.3L (GEN II)(2bbl.)	F601127-F000878	1996
4.3LX (GEN+)(2bbl.)	F803000-K999999	1996-97
4.3L (GEN+)(2bbl.)	L010044-SUP	1998-SUP
4.3L EFI (GEN+)(TBI)	L012009-SUP	1998-SUP
205 (4bbl.)	A331455-B527954	1985-87
205/4.3LX (4bbl.)	B527955-D714369	1987-91
4.3LX (GEN II)(4bbl.)	D714370-F001219	1992-93
4.3LX (GEN II)(4bbl.)	F001220-F601126	1993-95
4.3LX (GEN II)(4bbl.)	F601127-F802999	1996
4.3LXH (GEN+)(4bbl.)	F803114-SUP	1996-97
4.3LH(GEN+)(4bbl.)	L010044-SUP	1998
262 Mag. (TBI)(GEN+)	F803800-K999999	1996-97

FORD V8 (COLAS)		
MODELO	S/N	AÑO
888 (2bbl.)	3108723-4887829	1971-77
215 (4bbl.)	2781153-3385720	1970-72
225 (4bbl.)	3385721-4166999	1973-74

FORD V8 (COLAS) Cont.		
MODELO	S/N	AÑO
225-S (4bbl.)	3385721-4166999	1973-74
233	4173000-4902304	1975-77
255	3258728-4175499	1971-74

GM V8 283, 327, 305 & 350 CID		
MODELO	S/N	AÑO
190	1564539-1730903	1963-64
898 (2bbl.)	4762210-6218461	1977-82
898 (2bbl.)	6218462-B525981	1983-84
200/5.0L (2bbl.)	6218462-F600999	1985-95
5.0L (2bbl.)	L015751-SUP	1998-SUP
5.0L EFI	L012052-L340000	1998-99
228 (4bbl.)	4765100-5170008	1977-78
228 (4bbl.)	5170009-6218461	1979-82
228 (4bbl.)	6218462-B525981	1982-84
230 (4bbl.)	6218462-B525981	1985-86
230/5.0LX (4bbl.)	B525982-F600999	1987-95
225	1539620-2694014	1963-69
250	2314301-2639854	1968-69
255	4175500-4767999	1975-76
250	4768000-4908849	1977
260/5.7L	4908850-6218461	1978-82
260/5.7L	621462-B525981	1982-86
260/5.7L	B525982-F600999	1987-95
5.7L (2bbl.)	F601000-SUP	1996-98
5.7L EFI	F225560-SUP	1995-SUP
5.7LX (4bbl.)	F601000-K999999	1996-97
5.7LX EFI	F752400-K999999	1996-97
5.7LX Bravo EFI	F800300-K999999	1996-97
350 Mag. Alpha	A635178-B525981	1986-87
350 Mag. Alpha	B525982-F600999	1987-95
350 Mag. Alpha	F601000-K001526	1996
350 Mag. Alpha	K001527-K999999	1997
350 Mag. Alpha EFI	F800300-K999999	1996-97
350 Mag. Bravo MPI	F415189-K999999	1995-97
350 Mag. Bravo MPI (GEN +)	F602000-K999999	1996-97
350 Mag. MPI (GEN+)	L010019-SUP	1998-SUP
270	2851074-3385720	1969-72
280TRS	4176250-4770199	1975-76
300 Tempest	6668677-B430367	1985-86
320 (EFI)	A543604-C622418	1987-89

GM V8 427, 454, 502, 540 & 572 (COLAS)		
MODELO	S/N	AÑO
325	2278747-3780449	1969-72
330	4623115-6083144	1977-81
330	6083145-B816450	1982-87
7.4L Bravo	B771113-D603117	1988-91
7.4L Bravo (Gen.V)	D603118-F800699	1992-96
7.4L Bravo (Gen.VI)	F800700-K999999	1996-97
7.4LX Bravo (MPI)(Gen.V)	F602010-F801999	1996
7.4LX Bravo (MPI)(Gen.VI)	F802000-K999999	1996-97
7.4L MPI (Gen.VI)	L010003-SUP	1998
7.4LX Bravo (TBI)(Gen.VI)	F820000-K999999	1996-97
454 Mag. Alpha	A631894-SUP	1986-88
454 Mag. Bravo (Gen.V)	D805069-F304999	1992-94
454 Mag. Bravo (Gen.V)	F305000-F801699	1995-96
454 Mag. Bravo (Gen.VI)	F801700-K999999	1996-97
454 EFI (Gen.V)	F115700-F802349	1994-96
454 Mag. MPI (Gen.VI)	F802350-K999999	1996-97
454 Mag. MPI (Gen.VI)	L010029-L085399	1998
454 Mag. MPI (Gen.VI)	L085400-SUP	1999-SUP
370 TRS	4179554-6721527	1978-85
370 TRS	6721528-B714586	1985-87
400 TRS	4179554-B457644	1980-86
420	A398941-D937011	1987-89
425	A398941-D937011	1990-93
440 TRS	4179554-B485220	1983-86
450 (Gen.V)	F347100-F347277	1995-96
525 SC	D456000-F348963	1991-92
525 SC (Gen.V)	D456000-F348963	1992-95
525 SC (Gen.V)	F615814-F745215	1996
525 SC (Gen.VI)	F745260-SUP	1996-97
390	2781129-3042731	1969-70
460 TRS	4719554-6181046	1983-86
465	C849992-F213244	1990-92
465 (Gen.V)	C849992-F213244	1992-94
500 (Gen.V)	F213293-F745159	1994-96

GM V8 427, 454, 502, 540 & 572 (COLAS) Cont.

MODELO	S/N	AÑO
500 (Gen.VI)	F745195-L001772	1997-98
502 Mag. Bravo	C878221-D824588	1990-92
502 Mag. Bravo (Gen.V)	D824589-F114528	1992-93
502 EFI (Gen.V)	D840650-F802599	1993-96
502 Mag.MPI (Gen.VI)	F802600-K999999	1996-97
500 EFI	L001477-SUP	1999-UP
502 Mag.MPI (Gen.VI)	L085433-SUP	1998
600 SC	D456489-F877642	1991-92
600 SC (Gen.V)	D456489-F877642	1992-96
600 SC (Gen.VI)	K000227-SUP	1997
500 Bulldog	C577254-F745405	1990-96
500 Bulldog	K000248-SUP	1997
575	A677429-D763716	1986-92
800 SC (Gen.V)	D763836-SUP	1993-96

MCM 4,5,6 & V8 CILINDRO MOTOR DIESEL COLAS

MODELO	HP	S/N	AÑO
Rover	60	31400000F-SUP	1965-67
530 D-TA	150	B993000-B993492	1989
636 D-TA	180	B993500-C696047	1989
D183	140	B993493-D725149	1990-93
D219	170	C696048-D850124	1990-93
D254	200	C849484-D554729	1990-93
D3.0L	140	D725150-SUP	1994-SUP
D3.6L	170	D850125-SUP	1994-SUP
D4.2L	200	D554730-SUP	1994-SUP
D7.3L	238	F060000-SUP	1994-SUP

MERCURY MARINE MIE 4 CILINDRO (INTRABORDA)

MODELO	S/N	AÑO
470	5520115-6218036	1980-81

FORD MIE V8 (INTRABORDA)

MODELO	S/N	AÑO
215	2781153-3563181	1970-72
225	3385721-4176999	1970-72
233	4173000-4775784	1975-76
255	3258728-4178299	1973-74

GM MIE V8 305,327,350 CID (INTRABORDA)

MODELO	S/N	AÑO
198	4762210-6218461	1977
228	4765100-5170008	1977-78
228	5170009-5907057	1979-80
230/5.0L (4bbl.)	5907058-B788151	1981-87
225	2278647-2694014	1968
250	2314301-2639854	1968-69
255	4175500-5907057	1975-80
260/5.7L	5907058-F024999	1981-93
270	2851074-3077735	1969-72
5.7L	F025000-K999999	1994-97
5.7L (Gen+)	L002003-SUP	1998
5.7L MPI	K040300-K999999	1997
350 Mag. MPI (Gen+)	L002008-L304499	1998
350 Mag. MPI (Gen+)	L304500-SUP	1999
350 Horizon	L304700-SUP	1999-UP
5.7L Ski	A338533-B514626	1985-87
5.7L Competition Ski	B514627-F775199	1987-95
5.7L Competition Ski	F775200-K040003	1996
5.7L Competition Ski	K040004-K999999	1997
5.7L Competition Ski (Gen+)	L002005-SUP	1998-UP
350 Mag. Ski	D505450-K999999	1991-97
350 Mag. EFI Ski	F215561-K999999	1994-97
350 Mag. MPI Ski	F350583-F799999	1995-98
Black Scorpion Ski	F800000-SUP	1996-98

GM MIE V8 427, 454, 482 & 502 CID (INTRABORDA)

MODELO	S/N	AÑO
325	2278747-3780449	1968-74
330	4623115-5889913	1977-80
340/7.4L w/B/W MK4	5889914-SUP	1981-92
7.4L w/Hurth (LH) MK4	C391564-D715493	1989-92
7.4L (LH)	D715494-K999999	1992-97
7.4L MPI (LH)	F563052-K999999	1995-97
7.4L MPI (L29) Gen VI	L002006-SUP	1998
7.4L TBI (LH) Gen VI	F874815-K999999	1996-97
454 Mag. MPI Horizon	L002200-L086049	1998-99
454 EFI (SKI) (Gen.V)	F215800-F820099	1995-96
454 Mag. MPI (SKI)(Gen.VI)	F820100-K999999	1996-97
350	9780450-4623109	1974-76
390	2781129-2825059	1969-70
8.2L w/ Hurth	C878221-D857199	1990-92
8.2L (Gen.V)	D857200-F819619	1993-96
8.2L MPI (LH) Gen VI	F819620-K999999	1996-97

GM MIE V8 427, 454, 482 & 502 CID (INTRABORDA)

MODELO	S/N	AÑO
8.2L MPI (LH) Gen VI	L002450-L0086012	1998
8.2L MPI (LH) Gen VI	L0086013-SUP	1999

MIE 5, 6 & V8 CILINDRO MOTOR DIESEL INTRABORDA

MODELO	HP	S/N	AÑO
530 D-TA	150	B993002-C539258	1989
636 D-TA	180	B993750-C696011	1989
D183	150	C539259-D725149	1990-93
D219	180	C696012-D850124	1990-93
D254	210	C849461-D554729	1990-93
D3.0L	150	D725150-SUP	1994-SUP
D3.6L	180	D850125-SUP	1994-SUP
D4.2L	210	D554730-SUP	1994-SUP
D7.3L	262	F060000-SUP	1994-SUP

MC 60, 80 & 90 COLAS & TRANSOM PLATES

MODELO	S/N	AÑO
60 (O)	1830753-2063740	1965-66
80	2063741-2898029	1966-69
90	2898020-3225967	1970-72

MC I, II & III

MODELO	S/N	AÑO
I	1534570-1684187	1963
II (1.33:1)	1474909-2278488	1962-67

MC I, II & III Cont.

MODELO	S/N	AÑO
II (1.78:1)	2398798-2671321	1968-69
III	2373127-3002613	1968-72
III	5128065-SUP	1978-SUP

MC 1A, 1B & 1C

MODELO	S/N	AÑO
1A, 1B & 1C	1684188-1777798	1964
1A, 1B & 1C (E-Z Shift)	1776349-2065189	1965-66

MC 120, 140, 160 & 165

MODELO	S/N	AÑO
120/140	2062141-378049	1967-73
120/140	3780850-4893634	1974-77
120/140	4893635-6225576	1978-82
160	2065190-2763441	1967-69
165	2763442-3780849	1970-73
165	3780849-4890459	1974-77
165	4890460-6268064	1978-82

MC470 & 485

MODELO	S/N	AÑO
470	4208730-4893834	1976-77
470	4893835-6225576	1978-82
485	5487437-6225576	1980-82

MC 888, 225S & 233

MODELO	S/N	AÑO
888	3106717-3784374	1971-73
888	3784375-4782329	1974-77
225S	3856268-4200499	1974
233	4200500-4782329	1975-77

MC 898, 228, 250 & 260

MODELO	S/N	AÑO
898/228	4782330-4898729	1977
898/228	4898730-6229157	1978-82
250	4791300-4898729	1977
260	4898730-6229157	1978-82

MC R, MR, ALPHA ONE, ALPHA ONE SS & ALPHA ONE GEN II

MODELO	S/N	AÑO
R	6152230-6847029	1983-84
MR	6810538-A479506	1985
Alpha One	A470165-SUP	1986-90
Alpha One SS	A545004-SUP	1986-89
Alpha One Gen II	D469859-SUP	1991-SUP

MC BRAVO & BLACKHAWK

MODELO	S/N	AÑO
Bravo One	B664190-SUP	1988-SUP
Bravo Two	C564952-SUP	1989-SUP
Bravo Three	D763691-SUP	1993-SUP
Blackhawk	F186717-SUP	1994-SUP

MC 215E & 215H

MODELO	S/N	AÑO
215H	2782203-2909034	1970
215E	2782203-2909034	1970-72

MC TR & TRS

MODELO	S/N	AÑO
TR	3377316-3787239	1973
TR	3787240-4794899	1974-76
TR	4794900-5009866	1977
TR	5009867-SUP	1978-SUP
TRS	3787240-4203749	1974-75
TRS	4203750-4795399	1976
TRS	4795400-SUP	1977-SUP



**18-5291
KIT ENCENDIDO**
Reemplaza: 808483K2
Motores GM V-8 con Delco HEI-1998 y nuevos (excepto motores MPI con 555 ECM)
Incluye 18-5354 tapa & 18-5402 rotor



**18-5246
KIT ENCENDIDO**
Reemplaza: 898253T28
Para: Último modelo V-6, 4.3L (Alpha/Bravo)



**18-5247
KIT ENCENDIDO**
Reemplaza: 898253T29, 8M0061335, 8M0060495
Para: Último modelo V-8 (Alpha/Bravo 350 Mag, 5.0L, & MX 6.2L)



**18-5250
KIT ENCENDIDO**
Reemplaza: 34235T1, 34235Q1
—CONTIENE—
Ref # O.E. # Descripción
18-5311 34235 Juego de contactos
18-5345 33662 Condensador
18-5418 58217 Rotor
Delco 4 & 6 cil.



**18-5251
KIT ENCENDIDO**
—CONTIENE—
Ref # O.E. # Descripción
18-5314 391-5090 Juego de contactos
18-5338 391-5092 Condensador
18-5404-1 391-7057 Rotor
Mallory 8 cil. Tapa alta



**18-5253
KIT ENCENDIDO**
—CONTIENE—
Ref # O.E. # Descripción
18-5318 58033 Juego de contactos
18-5346 58034, 81-64851 Condensador
18-5420 65864 Rotor
Autolite 8 cil.



**18-5254
KIT ENCENDIDO**
—CONTIENE—
Ref # O.E. # Descripción
18-5317 64850, 87-71831 Juego de contactos
18-5346 58034, 81-64851 Condensador
18-5420 65864, 78016 Rotor
Mercury 8 cil.



**18-5258
KIT ENCENDIDO**
—CONTIENE—
Ref # O.E. # Descripción
18-5303 392-6325 Juego de contactos
18-5347 392-6324 Condensador
18-5407 392-6326 Rotor
Prestolite 8 cil.



**18-5260
KIT ENCENDIDO**
—CONTIENE—
Ref # O.E. # Descripción
18-5303 392-6325 Juego de contactos
18-5345 392-6324 Condensador
18-5403 392-9767 Rotor
Prestolite 8 cil.



**18-5266
KIT ENCENDIDO**
Para: Distribuidores 18-5481, 18-5482, 18-5483, 18-5477, 18-5478 y 18-5479
Incluye 18-5300 rotor



**18-5267
KIT ENCENDIDO**
—CONTIENE—
Ref # O.E. # Descripción
18-5318 58033 Juego de contactos
18-5346 58034, 81-64851 Condensador
18-5420 65864, 78016 Rotor
18-5389 393-4988T Tapa distribuidor
Autolite V-8 - terminal único



**18-5268
KIT ENCENDIDO**
—CONTIENE—
Ref # O.E. # Descripción
18-5311 34235 Juego de contactos
18-5345 33662 Condensador
18-5418 58217 Rotor
18-5385 393-9459 Tapa distribuidor
Delco en línea 4 - terminal único



**18-5269
KIT ENCENDIDO**
—CONTIENE—
Ref # O.E. # Descripción
18-5311 34235 Juego de contactos
18-5345 33662 Condensador
18-5418 58217 Rotor
18-5386 33765 Tapa distribuidor
Delco En línea 6 - terminal único



**18-5271
KIT ENCENDIDO**
—CONTIENE—
Ref # O.E. # Descripción
18-5314 391-5090 Juego de contactos
18-5338 391-5092 Condensador
18-5404-1 391-7057, 391-5088 Rotor
18-5376 391-5075 Tapa distribuidor
Mallory V-8 - Punto único - terminal único



**18-5273
KIT ENCENDIDO**
—CONTIENE—
Reemplaza: 805759T3 / 805759Q3
Ref # O.E. # Descripción
18-5431 13524A5 Rotor
18-5395 16457A4 Tapa distribuidor
Mercury Thunderbolt HEI - V-8

① Referencias acabadas en "D" envasadas - Referencias normales no envasadas



**18-5274
KIT ENCENDIDO**
—CONTIENE—

Ref #	O.E. #	Descripción
18-5432	13524A6	Rotor
18-5396	13753A2, 815407A2	Tapa distribuidor Mercury Thunderbolt HEI - V-6



**18-5275
KIT ENCENDIDO**
—CONTIENE—

Ref #	O.E. #	Descripción
18-5303	392-6325	Juego contactos
18-5347	392-6324	Condensador
18-5403	392-9089	Rotor
18-5352	392-9766	Tapa distribuidor
Prestolite V-8 -Sólo un platino - Tapa tornillos		



**18-5276
KIT ENCENDIDO**
—CONTIENE—

Ref #	O.E. #	Descripción
18-5303	392-6325	Juego contactos
18-5347	392-6324	Condensador
18-5403	392-9089	Rotor
18-5353	392-9086	Tapa distribuidor
Prestolite V-6 - Sólo un platino - Tapa tornillos		



**18-5277
KIT ENCENDIDO**
—CONTIENE—

Ref #	O.E. #	Descripción
18-5303	392-6325	Juego contacto
18-5347	392-6324	Condensador
18-5407	392-6326	Rotor
18-5369	392-6318	Tapa distribuidor
Prestolite V-8 - terminal único - Tapa tipo clip		



**18-5278
KIT ENCENDIDO**
Reemplaza: 850484T3
Delco EST - V-6

—CONTIENE—

Ref #	Descripción	O.E. #
18-5362	Tapa distribuidor	850484
18-5408	Rotor	850485



**18-5280
KIT ENCENDIDO**
Reemplaza: 811635Q2
Delco EST - En línea 4

—CONTIENE—

Ref #	Descripción	O.E. #	Cant.
18-5361	Tapa distribuidor	811635, T3	1
18-5406	Rotor	811636, 1	1



**18-5281
KIT ENCENDIDO**
Reemplaza: 808483Q2
Delco EST - V-8

—CONTIENE—

Ref #	Descripción	O.E. #	Cant.
18-5354	Tapa distribuidor	808483	1
18-5405	Rotor	808484, 1, 898253010	1



**18-5282
KIT ENCENDIDO**
Holley, Mercury Marine -
Sólo un platino V-8

—CONTIENE—

Ref #	Descripción	O.E. #
18-5389	Tapa distribuidor	393-4988T, 2
18-5420	Rotor	65864, 78016
18-5317	Juego contactos	64850, 87-71831
18-5346	Condensador	58034, 81-64851



**18-5283
KIT ENCENDIDO**
Para: Mallory Sólo un platino 4 en línea

—CONTIENE—

Ref #	Descripción	O.E. #
18-5397	Tapa distribuidor	-
18-5404-1	Rotor	391-7057
18-5314	Juego de contactos	391-5090
18-5338	Condensador	391-5092



**18-5301
KIT ENCENDIDO**
Reemplaza:
Para: Tapón macho V-8 flamethrower
distribuidor



**18-5302
KIT ENCENDIDO**
Reemplaza:
Para: Tapón macho V-8 flamethrower
distribuidor



**18-5303
JUEGO DE CONTACTOS**
Reemplaza: 392-898253005,
392-6325, 8M6001219,
FI6900031



**18-5311
JUEGO DE CONTACTOS**
Reemplaza: 34235, 34235T



**18-5314
JUEGO DE CONTACTO**
Reemplaza: 391-5090,
391-898253004, 8M6001250



**18-5317
JUEGO DE CONTACTO**
Reemplaza: 64850,
87-71831



**18-5318
JUEGO DE CONTACTO**
Reemplaza: 58033,
898253007



**18-5338
CONDENSADOR**
Reemplaza: 391-5092,
391-898253001, 391-5093,
391-5092, 8M6001217
FI6900040

 <p>18-5344 CONDENSADOR Reemplaza: 33706</p>	 <p>18-5345 CONDENSADOR Reemplaza: 33662, 898253003, 898253005, 33662Q, 6325, 8M6001218, FI6900031</p>	 <p>18-5346 CONDENSADOR Reemplaza: 58034, 81-64851</p>	 <p>18-5347 CONDENSADOR Reemplaza: 392-6324, 392-898253002, 8M6001249, FI6900023, FI6900032, FI6900083, FI6900189</p>	 <p>18-5402 ROTOR Reemplaza: 898253009 Motores GM V-8 con Delco HEI-1998 y nuevos (excepto motores MPI con 555 ECM)</p>
 <p>18-5245 ROTOR Reemplaza: 884790, 898253013 Para: Último modelo V-6, V-8 (Alpha/ Bravo 350 Mag, 5.0L, & MX 6.2L)</p>	 <p>18-5403 ROTOR Reemplaza: 392-9089, 392-9089T, 392-9767, 392-9089Q, FI6900186 FI6900190</p>	 <p>18-5404-1 ROTOR Reemplaza: 391-7057, 391-5088, 391-7057T, 391-898253029, 8M6001224, FI6901224</p>	 <p>18-5405 ROTOR Reemplaza: 808484, 808484 1, 898253010 Use con 18-5354 tapón distribuidor Para nuevos GM style "Modulo en tapa" distribuidores - V-8</p>	 <p>18-5406 ROTOR Reemplaza: 811636, 811636 1, 898253011 Use con 18-5361 tapón distribuidor 3.0L LX</p>
 <p>18-5407 ROTOR Reemplaza: 392-6326, 392-6326T, FI6900044</p>	 <p>18-5300 ROTOR Reemplaza: 33707 Para: Flamethrower Distribuidor</p>	 <p>18-5408 ROTOR Reemplaza: 850485, 8504851, 898253012, 8M0062084, 804424 Use con 18-5362 Tapa Distribuidor Para nuevos GM Style "Module in Cap" Distribuidores V6 Aplicaciones</p>	 <p>18-5418 ROTOR Reemplaza: 58217, 898253008, 58217Q</p>	 <p>18-5420 ROTOR Reemplaza: 65864, 78016</p>
 <p>18-5431 ROTOR Reemplaza: 13524A5, T1 V-8</p>	 <p>18-5432 ROTOR Reemplaza: 13524A6, 13524Q06, 13524A4, 19405A4, 90576A4 V-6</p>	 <p>18-5243 TAPA DISTRIBUIDOR Reemplaza: 888731, 898253T23 Para: Último modelo V-6 (4.3L Alpha/Bravo)</p>	 <p>18-5244 TAPA DISTRIBUIDOR Reemplaza: 884792, 858253T22 Para: Último modelo V-8 (Alpha/ Bravo 350 Mag, 5.0L, & MX 6.2L) Use juego cables 18-8821-1</p>	 <p>18-5352 TAPA DISTRIBUIDOR Reemplaza: 392-9766, 392-9766Q1, 392-9766T, FI6900185 Prestolite</p>
 <p>18-5353 TAPA DISTRIBUIDOR Reemplaza: 392-9086, 392-9086T</p>	 <p>18-5354 TAPA DISTRIBUIDOR Reemplaza: 808483, 808483T3, 804483T 804418 Para nuevos GM style "Modulo en tapa" Distribuidores-V-8 Use 18-5405 Rotor</p>	 <p>18-5361 TAPA DISTRIBUIDOR Reemplaza: 811635, 811635T3 Use 18-5406 Rotor 3.0L LX</p>	 <p>18-5362 TAPA DISTRIBUIDOR Reemplaza: 850484, 850484T, 850484T2 Para nuevos GM Style "Modulo en la tapa" Distribuidores - V6 Use 18-5408 Rotor</p>	 <p>18-5369 TAPA DISTRIBUIDOR Reemplaza: 392-6318, 392-6318T, FI6900184 Prestolite con juntas 18-5399</p>

 <p>18-5376 TAPA DISTRIBUIDOR Reemplaza: 391-5075, 391-5075Q1, FI6900148 Mallory</p>	 <p>18-5384 TAPA DISTRIBUIDOR Reemplaza: 33708</p>	 <p>18-5385 TAPA DISTRIBUIDOR Reemplaza: 393-9459, 393- 9459Q1, 393-9459T, 33667, FI6900052</p>	 <p>18-5386 TAPA DISTRIBUIDOR Reemplaza: 33765, 33765T</p>
 <p>18-5389 TAPA DISTRIBUIDOR Reemplaza: 393-4988T, 393- 4988T2, 393-4988, 393-3230</p>	 <p>18-5395 TAPA DISTRIBUIDOR Reemplaza: 16457A4, 805759T2, 805759T1, 805759A5, 805759A2, 805759A1, 90746A1, 43557A1, 43557 V-8</p>	 <p>18-5396 TAPA DISTRIBUIDOR Reemplaza: 13753A2, 815407A2 V-6</p>	 <p>18-5397 TAPA DISTRIBUIDOR Reemplaza: Mallory 9-29418 Para: Ford 2.3L con Mallory Distribuidor (87-90)</p>
 <p>18-5473 TAPA DISTRIBUIDOR Tapa distribuidor negro con terminales macho Flamethrower Distribuidores</p>	 <p>18-5474 TAPA DISTRIBUIDOR Tapa distribuidor rojo con terminales macho Flamethrower Distribuidor</p>	<p>Pack de 2</p>  <p>18-5399 18-5399-9① JUNTA TAPA DISTRIBUIDOR Reemplaza: 392-6329</p>	 <p>18-29417 TAPA DISTRIBUIDOR Reemplaza: Mallory 270B Para: Mallory 6 cilindro</p>

CARACTERÍSTICAS

- Relleno con aceite para mejor refrigeración y gran durabilidad
- Baja resistencia que produce una gran intensidad para un mejor encendido y economía de combustible
- Más hilos maximizan la energía y la fiabilidad sobre el rango de las RPM
- Se ajusta a los soportes existentes para una fácil instalación

 <p>18-5466 BOBINA ENCENDIDO ALTO RENDIMIENTO 1.5 ohm (aceite), negro - 8 cilindro: Flame-Thrower 40,000 voltios bobina.</p> <ul style="list-style-type: none"> • Usar con el kit de encendido de conversión electrónica original • Puede ser usado con otros sistemas de encendido 	 <p>18-5469 BOBINA DE ENCENDIDO DE ALTO RENDIMIENTO 3.0 ohm (aceite), negro - 4 & 6 cilindro: Flame-Thrower 40,000 voltios bobina.</p> <ul style="list-style-type: none"> • Usar con kit de conversión electrónica original • Puede ser usado con otros sistemas de encendido 	 <p>18-5472 BOBINA ENCENDIDO DE ALTO RENDIMIENTO 0,6 ohm (llenado aceite), negro - 4, 6, & 8 cilindros: Flame-Thrower 45,000 voltios bobina.</p> <ul style="list-style-type: none"> • Bobina de baja resistencia 0,6 ohm diseñada para usar con kits de conversión electrónica de alto rendimiento ignitor II
---	--	--

Ref No.	Descripción	bobina recomendada	Resistencia Ohms	Ref No.	Descripción	bobina recomendada	Resistencia Ohms
18-5294	Kit conversión electrónica	18-5469	3	18-5286	Kit conversión electrónica alto rend.	18-5472	0.6
18-5295	Kit conversión electrónica	18-5469	3	18-5288	Kit conversión electrónica alto rend.	18-5472	0.6
18-5296-2	Kit conversión electrónica	18-5466	1.5	18-5289	Kit conversión electrónica alto rend.	18-5472	0.6
18-5297	Kit conversión electrónica	18-5469	3	18-5290	Kit conversión electrónica alto rend.	18-5472	0.6
18-5298	Kit conversión electrónica	18-5466	1.5	18-5481	Flame-Thrower Distribuidor	18-5472	0.6
18-5299	Kit conversión electrónica	18-5466	1.5	18-5482	Flame-Thrower Distribuidor	18-5472	0.6
18-5285	Kit conversión electrónica Alto rend.	18-5472	0.6	18-5483	Flame-Thrower Distribuidor	18-5472	0.6

① Priced per Package

TAPA APLICACIONES COMIENZAN EN LA PÁGINA 388

 <p>18-5433 BOBINA ENCENDIDO Reemplaza: 38547, 32193A2, 392-806529A1, 898253T24 DELCO 1115202 (Utiliza resistencia externa)</p>	 <p>18-5438 BOBINA ENCENDIDO Reemplaza: 392-7803A4, 392-805570A2 HEI Thunderbolt encendido</p>	 <p>18-5465 BOBINA ENCENDIDO Reemplaza: 392-863704T, 8M0054588 2001 y nuevos 4.3L, 5.0L, 5.7L & 6.2L con 555 ECM (OM300000 y sup)</p>	 <p>18-7493 BOBINA Reemplaza: 392889925 Para: 8.1L & 496 Mag OM315053 & SUP</p>	 <p>18-7648 BOBINA ENCENDIDO Reemplaza: 392-881732</p>
 <p>18-5442 BOBINA ENCENDIDO Reemplaza: 806673T, T1</p>	 <p>18-5443 BOBINA ENCENDIDO Reemplaza: 817378T, 817378, 898253T27</p>	 <p>18-5117 MODULO DE ENCENDIDO Reemplaza: GM 10482803 Para: MCM MIE 4.3L MPI, 5.0L MPI, 350 Mag MPI y MX 6.2L MPI motores con ECM555 (2001 & sup) S/N OM300000 & sup</p>	 <p>18-5107-1 MODULO ENCENDIDO 4/6/8 cil. Reemplaza: 811637001, 811637002, 811637T, 811637, 850487, 804412, 802464 Delco EST</p>	 <p>18-5464 MODULO ENCENDIDO Para: Sierra 18-5481, 18-5482 and 18-5483 pico DISTRIBUIDORES ELECTRONICOS DE ALTO RENDIMIENTO (excepto HEI/EST)</p>
 <p>18-5488 MODULO ENCENDIDO Modulo de reemplazo para distribuidores electrónicos Mallory</p>	 <p>18-5108 SENSOR BOBINA DE PICK-UP Reemplaza: 811639, T V4/V6/V8 Delco EST</p>	 <p>18-5116-1 KIT SENSOR ENCENDIDO Reemplaza: 87-861780A2, Q4, 87-892150A02 Para: V-6 & V-8 con Thunderbolt encendido (1981-1997) conector tuercia</p>	 <p>18-7556 CIGÜENAL SENSOR Reemplaza: 864297001 Para: Mercury 5.0L, 6.2L 1998-2010</p>	 <p>18-7642 ENS. PICK-UP Reemplaza: 898141 Para: Motores equipados con Delco HVS distribuidor</p>
 <p>18-26810 GM HEI 4 TERMINAL Para: GM HEI Distribuidor con 4 terminales</p>	 <p>18-26811 GM HEI 2 TERMINAL Para: GM HEI Distribuidor con 2 terminales</p>	 <p>18-26812 HEI BOBINA CONECTOR</p>	 <p>18-26813 HEI BOBINA NEGRA CONECTOR</p>	 <p>18-61051 KIT TORNILLOS (4 por PACK) Para: Mercruiser V6 & V8 Thunderbolt Tapa distribuidor</p>



CARACTERÍSTICAS

- Ajuste automático de la bobina y se ajusta para mantener el pico en todo el rango de evoluciones del motor.
- Total disponibilidad de energía entre 3.000 y 5.000 RPM.
- Encendido más regular(estable)
- Usar con 18-5472 "Flame Thrower II" bobina de alto rendimiento

18-5285
**KIT CONVERSIÓN ELEC-
 TRÓNICO ALTO RENDIMIENTO**
 Para: 4 Cilindros Delco Distribuidor



18-5286
**KIT CONVERSIÓN
 ELECTRÓNICO ALTO
 RENDIMIENTO**
 Para: 6 Cilindros Delco Distribuidor



18-5288
**KIT CONVERSIÓN ELECTRÓNICO ALTO
 RENDIMIENTO**
 Para: Mayoría de distrib. Prestolite V-8 tapa fijada con clips



18-5289
KIT DE CONVERSIÓN
 Para: Mayoría de distribuidores prestolite tapa fijada con tornillos



18-5290
**KIT CONVERSIÓN ELECTRÓNICO
 ALTO RENDIMIENTO**
 Para: Mayoría de Mallory YL o YD 8 cil., rotación normal y contrarrotación.



IGNITOR
 ELECTRONIC IGNITION

CARACTERÍSTICAS

- Reemplaza platinos y condensador para un buen encendido
- Usa bobina tapa y rotor standard.
- Fácil de instalar, una pieza, 2-conexiones de cables.
- Con una tolerancia de 1/4° en el encendido 0 a 6000 RPM.
- Se pueden usar con bobina Flame Thrower 18-5466 y 18-5469.

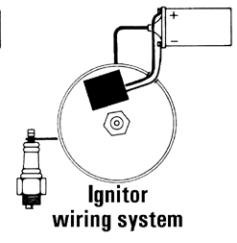
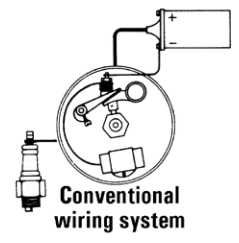

18-5294
KIT CONVERSIÓN ELECTRÓNICO
 Para: 6 Cil. Delco Distribuidor



18-5295
KIT CONVERSIÓN ELECTRÓNICO
 Para: Mayoría 4 Cil. Prestolite Distribuidores (Excepto IBM7026)
 Para: Onan, Universal, Waukesha, Wisconsin



18-5296-2D Display Package
18-5296-2
KIT CONVERSIÓN ELECTRÓNICO
 Para: Mayoría de Mallory YL o YD 8 cil., rotación normal y contratación.



18-5297 Display Package
KIT CONVERSIÓN ELECTRÓNICO
 Para 4 Cil. GM



18-5298
KIT CONVERSIÓN ELECTRÓNICO
 (con tapa fijada con clips) Para: Mayoría Prestolite V-8 Distribuidores



18-5299D Display Package
18-5299
KIT CONVERSIÓN ELECTRÓNICO
 (con tapa fijada) Para: Mayoría Prestolite V-8 Distribuidores
 Use con 18-5403 Rotor



APLICACIONES COMIENZAN EN LA PÁGINA 388

① Referencias acabadas en "D" envasadas - Referencia normal no envasada



CARACTERÍSTICAS

- Distribuidores mejoran el encendido y mejoran las prestaciones.
- Los componentes de alta calidad utilizados garantizan una larga vida.
- Mejoran las prestaciones y la potencia.

Standard Rotation

CCW Rotation

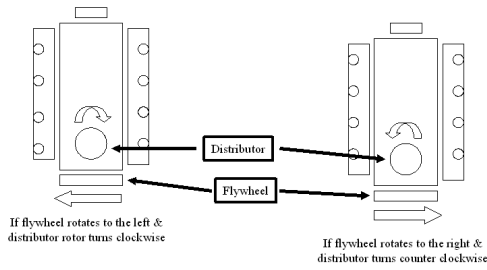

18-5481
DISTRIBUIDOR ELECTRÓNICO ALTO RENDIMIENTO
 Para: Ford V-8 351 Windsor
 Reemplaza tapa/rotor kit: 18-5266

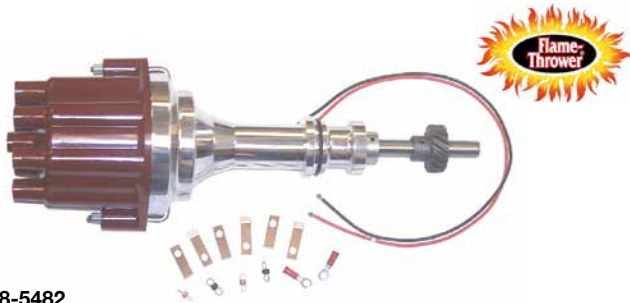

18-5482
DISTRIBUIDOR ELECTRÓNICO ALTO RENDIMIENTO
 Para: motores Ford V-8 351 Cleveland, 351M, 400, 429 y 460
 Reemplaza tapa/rotor kit: 18-5266



18-5483
DISTRIBUIDOR ELECTRÓNICO ALTO RENDIMIENTO
 Para: bloque motor Chevrolet marine pequeño y grande (altura de cubierta estándar)
 Reemplaza tapa/rotor kit: 18-5266

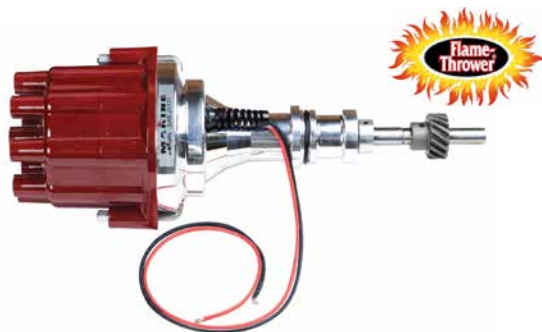

18-5477
DISTRIBUIDOR ELECTRÓNICO
 Para: motor Ford 302 V-8
 Reemplaza tapa/Rotor Kit 18-5266

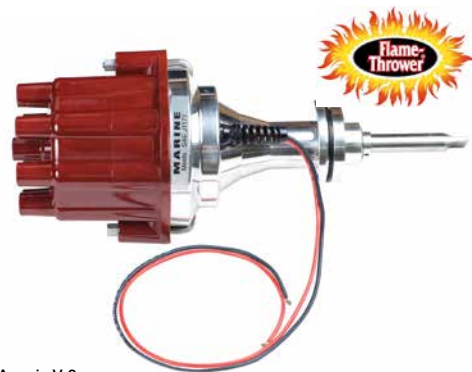

18-5478
DISTRIBUIDOR ELECTRÓNICO
 Para: motor Chrysler LA serie V-8
 Reemplaza tapa/Rotor Kit 18-5266



18-5479
DISTRIBUIDOR ELECTRÓNICO
 Para: motor GM V-8 rotación reverso
 Reemplaza tapa/Rotor Kit 18-5266



18-5480
KIT DE CONVERSIÓN DE ENCENDIDO COMPLETO
 Para: GM SB & BB con altura cubierta estándar
 —CONTIENE—

Ref #	Descripción
18-5472	Bobina
18-8803-2	Juego cables
18-5483	Distribuidor

18-26002-1
KIT SISTEMA ENCENDIDO
 Para: motores GM 4.3L/262 CID



18-5470
THUNDERBOLT IV V-8 DISTRIBUIDOR
 Reemplaza: 805185A36
 Para: motores GM V-8
 Kit encendido 18-5273



18-5471
THUNDERBOLT IV V-6 DISTRIBUIDOR
 Reemplaza: 805185A37
 GM V-6 motor
 Kit encendido 18-5274



18-5350
DISTRIBUIDOR
 Reemplaza: 888751A03, 888751A02, 888751A1
 Para: Vortec V-6 4.3L MPI (2002-SUP) (S/N OM300000 y SUP)



18-5351
DISTRIBUIDOR
 Reemplaza: 884794A02, 884794A1
 Para: Vortec V-8 2001 y sup 5.0L/ 5.7L/ 6.2L MPI motores (S/N OM300000 y sup)



18-5475
DISTRIBUIDOR
 Reemplaza: 817377, 817377T
 PARA: 4 CIL GM CON DELCO EST ENCENDIDO
 KIT ENCENDIDO 18-5280



18-5476
DISTRIBUIDOR
 Reemplaza: 807964A1, 907964A1
 Para: Motores GM V-6 con Delco EST encendido HEI
 Kit encendido 18-5278



18-5484-1
DISTRIBUIDOR ELECTRÓNICO
ROTACIÓN CONVENCIONAL
 Reemplaza: 805222A1
 Último modelo HEI
 Para V8 — 262-454 & 502 excepto 384/ 409 y bloques grandes
 • Diseñado como reemplazo de enchufe para distribuidores de combustible con sistema de inyección tipo GM.



— CONTIENE —

Descripción	Ref #
Tapa distribuidor	18-5354
Rotor	18-5405

Kit encendido 18-5281

18-26111-1
DISTRIBUIDOR
 Reemplaza: Mallory YL648AV
 Para: Mercruiser 3.7L L4/LH



18-5486-2
DISTRIBUIDOR ELECTRÓNICO
 Rotación convencional
 Para Chevrolet L4, 153 & 181 CID



— CONTIENE —

Ref #	Descripción
18-5397	Tapa distribuidor
18-5488	Modulo
18-5404-1	Rotor

18-5487-2
DISTRIBUIDOR ELECTRÓNICO
 Reemplaza: 9-26309, Mallory YLM676AV
 Rotación convencional
 Para GM L6, 194, 230, 250, 292 CID



— CONTIENE —

Ref #	Descripción
18-5488	Modulo
18-5404-1	Rotor

18-5489-2
DISTRIBUIDOR ELECTRÓNICO
 Rotación convencional
 Para Ford V8 351W CID



— CONTIENE —

Ref #	Descripción
18-5376	Tapa distribuidor
18-5488	Modulo
18-5404-1	Rotor

18-5494-2
DISTRIBUIDOR ELECTRÓNICO
 Rotación convencional
 Para Chevrolet todos V8 incluyen 482, 502, 540 CID (Excepto 348,409 & bloque grande para cubierta)



— CONTIENE —

Ref #	Descripción
18-5376	Tapa distribuidor
18-5488	Modulo
18-5404-1	Rotor

18-5495-2
DISTRIBUIDOR ELECTRÓNICO
 Rotación convencional
 Para Ford V8 302 CID



— CONTIENE —

Ref #	Descripción
18-5376	Tapa distribuidor
18-5488	Modulo
18-5404-1	Rotor

18-5496-2
DISTRIBUIDOR ELECTRÓNICO
 Reemplaza: YLM567CV
 Rotación convencional
 Para: Ford V8 351C — 460 CID



— CONTIENE —

Ref #	Descripción
18-5376	Distribuidor tapa
18-5488	Modulo
18-5404-1	Rotor

18-5497-2
DISTRIBUIDOR ELECTRÓNICO
 Reemplaza: YLM579AV
 Rotación convencional
 Para Chrysler V8 273,318 (67 & SUP) 340, 360 CID "LA"



— CONTIENE —

Ref #	Descripción
18-5376	Distribuidor tapa
18-5488	Modulo
18-5404-1	Rotor

18-5309-1
DISTRIBUIDOR
 Contacto controlado (Rotación estándar)
 Reemplaza: Mallory YL512CV
 Para mayoría de motores Ford 302 CID V-8
 Kit encendido 18-5251



— CONTIENE —

Ref #	Descripción
18-5314	Juego de contactos
18-5338	Condensador
18-5404-1	Rotor

18-5312-1
DISTRIBUIDOR (Contacto controlado)
 Reemplaza: Mallory YL554CV
 Para mayoría de motores Ford 351 CID V-8
 Kit encendido 18-5251



18-5313-1
DISTRIBUIDOR
 Contacto controlado (rotación estándar)
 Reemplaza: 17177A1, 91823A3, 816148A1, 74905A3, 68521A4, 68521A3, 13447A1
 Mallory YL624AV
 Para mayoría de motores GM V-8 (pequeño & gran bloque) Mallory tapa alta
 Kit encendido 18-5251



— CONTIENE —

Ref #	Descripción
18-5314	Juego de contactos
18-5338	Condensador
18-5404-1	Rotor

18-5315-1
DISTRIBUIDOR
 Contacto controlado (Standard Rotation)
 Reemplaza: 87581, 87581T, 62424, 58231, 52352, 33266, 195141
 Mallory YL673AV
 Para mayoría de motores GM 4 Cil (120 & 140 HP)
 kit en encendido 18-5251



— CONTIENE —

Ref #	Descripción
18-5314	Juego de contactos
18-5338	Condensador
18-5404-1	Rotor



18-5498-2
DISTRIBUIDOR ELECTRÓNICO
Reemplaza: 9-26307; Mallory YLM624BV
Para GM V8, 482, 502, 540 CID (Excepto 348, 409 & bloque grande para cubierta) (Rotación reverso)



18-5316-1
DISTRIBUIDOR
Reemplaza: Mallory YL624BV
Para mayoría GM V8 (Rotación reverso)



18-5339-1
DISTRIBUIDOR
Reemplaza: 9-26103; Mallory YL566AV
Para GM V8 327



18-26110-1
DISTRIBUIDOR
Reemplaza: 9-26110; Mallory YL579AV
Para Chrysler V8, 273, 318 (1967 & Sup), motores 340 y 360 "LA"



18-26104-1
DISTRIBUIDOR
Reemplaza: 9-26104; Mallory YL567EV
Para Ford V8 351C



18-26112-1
DISTRIBUIDOR
Reemplaza: 9-26112; Mallory YL676AV
Para GM L6, 194, 230, 250, 292 CID (Rotación convencional)



18-5512
I/L 4 Delco EST kit conversión
Descripción: Convierte motores electrónicos de 4 cilindros
Incluye: Distribuidor, Bobina, cables encendido, y cableados



18-5513
V-6 DELCO EST KIT CONVERSIÓN
Descripción: Convierte 6 Cilindro motor electrónico GM
Incluye: Distribuidor, bobina, Cables encendido, y cableados



18-5514
V-8 DELCO EST KIT CONVERSIÓN
Descripción: Convierte 8 Cilindros motores electrónicos GM
Incluye: Distribuidor, bobina, cables encendido, y cableados



18-5518
I/L 4 Sierra Electrónico kit conversión distribuidor
Descripción: Convierte 4 Cilindros GM Motores electrónicos
Incluye: Distribuidor, bobina, cables encendido, y cableados



18-5519
I/L 6 Sierra Electrónico kit conversión distribuidor
Descripción: Convierte 6 Cilindros GM motores electrónicos
Incluye: Distribuidor, bobina, cables encendido, y cableados



18-5520
V-8 KIT DISTRIBUIDOR CONVERSIÓN ELECTRÓNICA
Descripción: Convierte 8 Cilindro motores electrónicos GM
Incluye: Distribuidor, bobina, cables encendido, y cableado

MODELO	Cil.	Tipo encendido	Año	Serie #	Kit encendido	Juego de contactos	Rotor	Dist. tapa	Bobina	Distribuidor	Cables de bujías
110	153/4	⊙	1963-1966	1537370-2044033	18-5250 ★	18-5311	18-5418	18-5385	18-5433	18-5315-1	18-8800-1
					18-5268 ☞						
120	153/L4	⊙	1964-1986	1666601 - B531853	18-5250 ★	18-5311	18-5418	18-5385	18-5433	18-5315-1	18-8800-1
					18-5268 ☞						
2.5L	153/L4	⊙	1987-1989	B531854 - C853255	18-5250	18-5311			18-5433		
PRESTOLITE REPLC IGN	4 CIL	⊙	1963-1989	1537370 - C853255		18-5303	18-5403				
140	181/L4	⊙	1968-1986	2508261 - B450800	18-5250 ★	18-5311	18-5418	18-5385	18-5433	18-5315-1	18-8800-1
					18-5268 ☞						
3.0L	181/L4	⊙	1987-1989	B450801 - C856558	18-5250	18-5311			18-5433		
3.0L	181/L4	⊙	1990-1991	C856559 - D504541		18-5303	18-5403		18-5433		
3.0L	181/L4	⊕	1990-1991	C856559 - D504541							18-8811-1
3.0L	181/L4	⊙	1991-1994	D504542 - F603999				18-5361	18-5443		18-8833-1
3.0L	181/L4	⊙	1998-2010	L010042 - & SUP				18-5361	18-5443		18-8833-1
3.0L MPI	181/L4	⊙	2008-2010	A072812 - & SUP				18-5361	18-5443		18-8833-1
3.0LX	181/L4	⊕	1990-1991	C856559 - D504541							18-8811-1
3.0LX	181/L4	⊙	1991-1997	D504542 - K999999				18-5361	18-5443		18-8833-1
3.0L/ LX	L4		1990-1995	C856559 - F603999	18-5262	18-5303	18-5403		18-5433	18-5315-1	18-8800-1
3.0L/ LX	L4		1990-1995	C856559 - F603999							18-8811-1
3.0L/LX	L4		1996 & SUP	F604000 & SUP	18-5280		18-5406	18-5361	18-5443		18-8833-1
PRESTOLITE REPLC IGN	4 CYL	⊙	1968-1991	2508261 - D504541		18-5303	18-5403				
165	224/L4	⊙	1987	B434941 - B774251	18-5250	18-5311			18-5433		
170	224/L4	⊙	1985-1986	6916779 - B434940	18-5250	18-5311			18-5433		
180	224/L4	⊙	1987	B436391 - B775248	18-5250	18-5311			18-5433		
180	224/L4	⊙	1987-1989	B436391 - B775248		18-5303	18-5403		18-5433		
190	224/L4	⊙	1985-1986	6916779 - B436390	18-5250	18-5311			18-5433		
3.7L	224/L4	⊙	1988-1989	B774252 - & SUP	18-5250	18-5311			18-5433		
3.7LX	224/L4	⊙	1988-1989	B775249 - & SUP	18-5250	18-5311			18-5433		
3.7LX	224/L4	⊙	1988-1989	B775249 - & SUP		18-5303	18-5403		18-5433		
470	224/L4	⊙	1976-1984	4208730 - 6916778	18-5250 ★	18-5311	18-5418	18-5385	18-5433		18-8808-2
165, 170, 190 (224CID)	L4		1985-1989	6916779 & SUP	18-5250 ★	18-5311	18-5418	18-5385	18-5433		18-8808-2
					18-5268 ☞						
180LX	L4		1987-1989	B436391 & SUP	18-5250 ★	18-5311	18-5418	18-5385	18-5433		18-8808-2
					18-5268 ☞						
180LX	L4		1987-1989	B436391 & SUP	18-5262	18-5303	18-5403		18-5433		18-8808-2
160, 165(250cid)	L6		1967-1981	2048022-5813433	18-5250 ★	18-5311	18-5418	18-5386	18-5433		18-8809-1
					18-5269 ☞						
485	224/L4	⊙	1980-1982	5685394 - 6218036	18-5250	18-5311			18-5433		
488	224/L4	⊙	1983-1984	6170297 - 6916778	18-5250	18-5311			18-5433		
PRESTOLITE REPLC IGN	4 CIL	⊙	2010			18-5303	18-5403				
140	194/L6	⊙	1963	1538930 - 1725960	18-5250 ★	18-5311	18-5418	18-5386		18-5312-1	18-8809-1
					18-5269 ☞						
150	230/L6	⊙	1964-1966	1666495 - 2048046	18-5250 ★	18-5311	18-5418	18-5386			18-8809-1
					18-5269 ☞						
160	250/L6	⊙	1967-1970	2048022 - 2771483	18-5250	18-5311		18-5386	18-5433		
165	250/L6	⊙	1971-1981	2771484 - 5813433	18-5250	18-5311		18-5386	18-5433		
200	292/L6	⊙	1969	2453769 - 2712072	18-5250 ★	18-5311	18-5418	18-5386	18-5433	18-5487-2	18-8809-1
					18-5269 ☞						
PRESTOLITE REPLC IGN	6 CYL	⊙	2010			18-5303	18-5403	18-5353	18-5433		
185 (4 bbl)	229/V-6	⊙	1983-1984	6330183 - 6919655	18-5262 ★	18-5303	18-5403	18-5353	18-5433		18-8801-1
					18-5276 ☞						
175	262/V-6	⊙	1987	B527955 - B773242			18-5432	18-5396	18-5438		
175, 185, 4.3	262/V-6		1985-1993	6919656 - F000877	18-5274		18-5432	18-5396	18-5438		18-8810-1
185 (2bbl)	262/V-6	⊙	1985-1987	6919656 - B527954			18-5432	18-5396	18-5438		

- ⊙ Mallory encendido
- ⊙ Prestolite
- ⊙ Autolite
- ⊙ Mercury encendido
- ⊙ Holley
- ⊙ Thunderbolt IV
- ⊙ con tornillo bajo la tapa
- ⊙ Delco
- ⊙ Electronic dist. (rotación std) excluyendo thunderbolt encendido
- ⊙ Delco EST
- ⊕ Sistema digital Delco
- ★ Sin tapa dist
- ☞ Con tapa dist
- ☛ Mercury HEI
- ☛ Delco HEI
- ♣ Thunderbolt V
- ♣ Prestolite con clip bajo la tapa distribuidor
- ⊕ Controlador contacto dist. (Rotación std) excl. Thunderbolt enc.

MODELO	Cil.	Tipo encendido	Año	Serie #	Kit encendido	Juego de contactos	Rotor	Dist. tapa	Bobina	Distribuidor	Cables de bujías
205	262/V-6	⊕	1985-1987	A331455 - B775129			18-5432	18-5396	18-5438		
205, 4.3LX 4bbl	262/V-6		1985-19996	A331455 - F802999	18-5274		18-5432	18-5396	18-5438		18-8810-1
262 TBI (GEN +)	262/V-6	⊕	1996-1997	F803800 - K999999					18-5443		18-8835-1
4.3L (2bbl)	262/V-6	⊕	1988-1996	B773243 - F802999			18-5432	18-5396	18-5438		
4.3L (2bbl) (GEN +)	262/V-6	⊕	1998-2010	L010044 & SUP			18-5432	18-5396			
4.3L EFI (GEN +) (TBI)	262/V-6	⊕	1998	L012009 - L359999					18-5438		18-8835-1
4.3L EFI (GEN +) (TBI)	262/V-6	⊕	1999-2001	L360000 - M299999			18-5432	18-5396	18-5438		
4.3L MPI	262/V-6	⊕	2002-2010	M300000 & SUP	18-5246		18-5245	18-5243	18-5465	18-5350	18-8829-1
4.3LH (GEN +) (4bbl)	262/V-6	⊕	1998-2002	L010044 - M614999			18-5432	18-5396	18-5438		
4.3LX (4bbl)	262/V-6	⊕	1988-1996	B775130 - F802999			18-5432	18-5396	18-5438		
4.3LX (GEN +) (2bbl)	262/V-6	⊕	1996-1997	F803000 - K999999			18-5432	18-5396	18-5438		
4.3L/LH/LX/LXH	V6		1996-2001	F803000 & SUP	18-5274		18-5432	18-5396	18-5438		18-8810-1
Alpha(Gen+)											
4.3L/LH/LX/LXH	V6		1996-2001	F803000 & SUP	18-5274		18-5432	18-5396	18-5438		18-8810-1
Bravo(Gen+)											
4.3L EFI,262	V6		1996-1998	F803000- L359999	18-5278		18-5408	18-5362	18-5443		18-8810-1
Mag(TBI)(Gen+)											
4.3L EFI(TBI)	V6		1996 & sup	L012009 - L359999	18-5278		18-5408	18-5362	18-5443	18-5476	18-8835-1
(Gen+)				L360000 & SUP	18-5274		18-5432	18-5396	18-5438		18-8835-1
4.3L EFI(TBI)	V6		1999-2001	L360000 & SUP	18-5274		18-5432	18-5396	18-5438		18-8810-1
215 MCM & MIE (FORD)	302/V-8	⊕	1970-1972	2781153 - 3563181	18-5253 ★	18-5318	18-5402	18-5389	18-5433	18-5495-2⊕	18-8803-2
					18-5267 ☐					18-5309-1 ⊕	
215 MCM & MIE (FORD)	302/V-8	⊕	1970-1972	2781153 - 3563181	18-5251 ★	18-5314	18-5404-1	18-5376	18-5433	18-5495-2⊕	18-8803-2
					18-5271 ☐					18-5309-1 ⊕	
225 MCM & MIE (FORD)	302/V-8	⊕	1973-1974	3385721 - 4166999	18-5253 ★	18-5318	18-5420	18-5389	18-5433	18-5495-2⊕	18-8803-2
Ford(302cid)					18-5267 ☐					18-5309-1 ⊕	
225 MCM & MIE (FORD)	302/V-8	⊕	1973-1974	3385721 - 4166999	18-5251 ★	18-5314	18-5404-1	18-5376	18-5433	18-5495-2⊕	18-8803-2
					18-5271 ☐					18-5309-1 ⊕	
225 MCM & MIE (FORD)	302/V-8	⊕	1973-1974	3385721 - 4166999	18-5254 ★	18-5317	18-5420	18-5389	18-5433	18-5495-2⊕	18-8803-2
					18-5267 ☐					18-5309-1 ⊕	
888 (FORD)	302/V-8	⊕	1971-1977	3108723 - 4887829	18-5254	18-5317	18-5420	18-5389	18-5433	18-5495-2⊕	18-8803-2
										18-5309-1 ⊕	
888 (FORD)	302/V-8	⊕	1971-1977	3108723 - 4887829	18-5253	18-5318	18-5420	18-5389	18-5433	18-5495-2⊕	18-8803-2
888 (FORD)	302/V-8	⊕	1971-1977	3108723 - 4887829	18-5258 ★	18-5303	18-5407	18-5369	18-5433	18-5495-2⊕	
					18-5277 ☐					18-5309-1 ⊕	18-8803-2
888 (FORD)	302/V-8	⊕	1971-1977	3108723 - 4887829	18-5251 ★	18-5314	18-5404-1	18-5376	18-5433	18-5495-2⊕	
					18-5271 ☐					18-5309-1 ⊕	18-8803-2
190 (GM 283)	283/V-8	⊕	1963-1964	1564539 - 1730903	18-5252	18-5310	18-5417	18-5384	18-5438	18-5498-1⊕	
										18-5494-2⊕	
										18-5313-1 ⊕	
198 MIE	305/V-8	⊕	1977	4776402 - 4931099		18-5314	18-5404-1		18-5433		
200 (5.0L)	305/V-8	⊕	1985-1995	6899058 - F600999			18-5431	18-5395	18-5438		
228	305/V-8	⊕	1977-1982	4765100 - 6218461		18-5314	18-5401-1		18-5433		
228	305/V-8	⊕	1982-1984	6218462 - 6899268			18-5431	18-5395	18-5438		
228 MIE	305/V-8	⊕	1977-1980	4765100 - 5907057		18-5314	18-5401-1		18-5433		
228 MCM & MIE	305/V-8		1977-1984	4765100 - 6218461	18-5251 ★	18-5314	18-5404-1	18-5376	18-5433		18-8803-2
					18-5271 ☐					18-5498-1⊕	
228	305/V-8		1985-1986	6218462 - 6899268	18-5273		18-5431	18-5395	18-5438	18-5494-2⊕	18-8804-1
										18-5498-1⊕	
230, 5.0L/LX MIE	305/V-8		1981-1995	5907058 - F600999	18-5273		18-5431	18-5395	18-5438	18-5494-2⊕	18-8804-1
										18-5498-1⊕	
198, 898 MCM &	305/V-8		1977-1982	4776402 - 6218461	18-5251 ★	18-5314	18-5404-1	18-5376	18-5433	18-5494-2⊕	18-8803-2
					18-5271 ☐					18-5498-1⊕	
230	305/V-8	⊕	1985-1987	6899269 - MB773739			18-5431	18-5395	18-5438		

⊕ Mallory encendido
 ⊕ Prestolite
 ⊕ Autolite
 ⊕ Mercury encendido
 ⊕ Holley
 ⊕ Thunderbolt IV

⊕ Con tornillo bajo la tapa
 ⊕ Delco
 ⊕ Dist. electrónico (rotación std) excluye Thunderbolt encendido
 ⊕ Delco EST
 ⊕ Sistema digital Delco
 ★ Sin tapa dist

☐ Con tapa dist
 ☐ Mercury HEI
 ☐ Delco HEI
 ⚡ Thunderbolt V
 ♥ Prestolite con clip bajo la tapa distribuidor
 ⊕ Controlador de contacto dist. (Std. Rotation) excl. Thunderbolt enc.

MODELO	Cil.	Tipo encendido	Año	Serie #	Kit encendido	Juego de contactos	Rotor	Dist. tapa	Bobina	Distribuidor	Cables de bujías
230 MIE	305/V-8	⊙	1981-1987	5907058 - B788151			18-5431	18-5395	18-5438		
5.0L (GEN +)	305/V-8	⬆	1988-2010	L015751 & SUP			18-5431	18-5395	18-5438		
5.0L EFI (Gen+)	305/V-8	⊙	1998	L012052 - L331630	18-5281		18-5405	18-5354	18-5442	18-5494-2 ⊙	18-8836-1
										18-5498-1 ⊙	
5.0L EFI (GEN +)	305/V-8	⊙	1998	L331651 - L339999					18-5442		
5.0L EFI (GEN +)	305/V-8	⊙	1999	L331631 - L331650			18-5431		18-5438		
5.0L MPI	305/V-8	⊙	2002-2010	M300000 & SUP							18-8828-1
5.0L MIE	305/V-8	⊙	1988	B788152 - C396832			18-5431	18-5395	18-5438		
5.0LX	305/V-8	⊙	1988-1995	B773740 - F600999			18-5431	18-5395			
898	305/V-8	⊙	1977-1982	4762210 - 621461		18-5314	18-5404-1		18-5433		
898	305/V-8	⊙	1983-1984	6218462 - 6899057			18-5431	18-5395	18-5438		
350MAG MPI	V8		1998-2001	L302200 & SUP	18-5273		18-5431	18-5395	18-5438	18-5494-2	
(Gen+) &										18-5498-1	
MIE(Gen+)											
350 MAG MPI	V8		2001-2004	M300000 & SUP	18-5247		18-5245	18-5244	18-5465	18-5351	
350 MAG MPI					18-5247		18-5245	18-5244			
HORIZON											
350 MAG	V8		1999-2001	L304700 & SUP	18-5273		18-5431	18-5395	18-5438	18-5494-2	
HORIZON MIE										18-5498-1	
350 MAG HORIZON	V8		2001-2004	M300000 & Sup	18-5247		18-5245	18-5244	18-5465	18-5351	
MIE											
350MAG MPI	V8		1999-2001	L304600 & Sup	18-5273		18-5431	18-5395	18-5438	18-5494-2	
SKI(Gen+)										18-5498-1	
350MAG SKI	V8		1991-1996	D505450 - K040399	18-5273		18-5431	18-5395	18-5438	18-5494-2	
										18-5498-1	
350MAG SKI	V8		1991-1996	D505450 - K040399	18-5273		18-5431	18-5395	18-5438	18-5494-2	
										18-5498-1	
350MAG SKI	V8		1991-1997	D505450 - K999999	18-5273		18-5431	18-5395	18-5438	18-5494-2	
										18-5498-1	
225 (GM)	327/V-8	⊙	1963-1969	1539620 - 2694014	18-5252 ★	18-5310	18-5417	18-5384	18-5433	18-5494-2 ⊙	18-8803-2
					18-5270 ☞					18-5498-1 ⊙	
										18-5313-1 ⚡	
225 MIE (GM)	327/V-8	⬆	1968	2278647 - 2694014	18-5282		18-5420	18-5389		18-5494-2 ⊙	18-8803-2
										18-5498-1 ⊙	
250 MCM & MIE	327/V-8	⬆	1968-1969	2314301 - 2639854	18-5282		18-5420	18-5389		18-5494-2 ⊙	18-8803-2
										18-5498-1 ⊙	
250	350/V-8	⊙	1977	4768000 - 4908849	18-5251 ★	18-5314	18-5404-1	18-5376	18-5433	18-5494-2 ⊙	18-8803-2
					18-5271					18-5498-1 ⊙	
250 MCM & MIE (GM)	350/V-8	⊙	1975-1976	3258728 - 4521254		18-5317	18-5420	18-5389	18-5433		
255 MCM (GM)	350/V-8	⊙	1976	4498701 - 4767999		18-5314	18-5404-1		18-5433		
255 MIE	350/V-8	⊙	1976-1980	4498701 - 5907057		18-5314	18-5404-1				
260	350/V-8	⊙	1978-1982	4908850 - 6218461		18-5314	18-5404-1		18-5433		
270 MCM & MIE	350/V-8	⬆	1969-1972	2851074 - 3385720	18-5282		18-5420	18-5389	332- 4895A 8	18-5494-2 ⊙	18-8803-2
										18-5498-1 ⊙	
280 TRS	350/V-8	⊙	1975	4176250 - 4499390		18-5317	18-5420	18-5389	18-5433		
280 TRS	350/V-8	⊙	1976	4499391 - 4770199	18-5251 ★	18-5314	18-5404-1	18-5376	18-5433	18-5494-2 ⊙	18-8803-2
					18-5271 ☞					18-5498-1 ⊙	
										18-5313-1 ⚡	
300	350/V-8	⊙	1985-1986	6668677 - B430367			18-5431	18-5395	18-5438		
320 EFI	350/V-8	⊙	1987-1989	A543604 - C622418			18-5431	18-5395	18-5438		
350 MAG ALPHA	350/V-8	⊙, ⬆	1986-1997	A635178 - K999999			18-5431	18-5395	18-5438		
350 MAGALPHA EFI (GEN +)	350/V-8	⊙	1996-1997	F800300 - K999999	18-5281		18-5405	18-5354	18-5442	18-5494-2 ⊙	18-8836-1
350 MAG BRAVO MPI	350/V-8	⊙	1995-1997	F415189 - K999999				18-5354	18-5443	18-5498-1 ⊙	18-8836-1
350 MAG EFI SKI	350/V-8	⊙	1994-1997	F215561 - K999999				18-5354	18-5443		18-8832-1

- ⊙ Mallory Ignition
- ⊙ Prestolite
- ⊙ Autolite
- ⊙ Mercury Ignition
- ⊙ Holley
- ⊙ Thunderbolt IV
- ⊙ Con tornillo bajo la tapa
- ⊙ Delco
- ⊙ Dist. electrónico (rotación std) excluye Thunderbolt encendido
- ⊙ Delco EST
- ⊙ Sistema digital Delco
- ★ Sin tapa dist
- ☞ Con tapa dist
- ★ Mercury HEI
- ⊙ Delco HEI
- ⬆ Thunderbolt V
- ♥ Prestolite con clip bajo la tapa distribuidor
- ⚡ Controlador contacto dist. (Rotación std) excl. Thunderbolt enc.

MODELO	Cil.	Tipo encendido	Año	Serie #	Kit encendido	Juego de contactos	Rotor	Dist. tapa	Bujía	Distribuidor	Cables de bujías
350 MAG MPI (GEN +)	350/V-8	ESP	1998	L010019 - L325962	18-5281		18-5405	18-5354	18-5442	18-5494-2ⓐ	18-8832-1
										18-5498-1ⓑ	
350 MAG MPI (GEN +)	350/V-8	☛	1999-2001	L325953 - M999999			18-5431	18-5395	18-5438		
350 MAG MPI	350/V-8	ESP	2002-2010	M300000 & SUP				18-5244			18-8828-1
350 MAG MPI HORIZON	350/V-8	ESP	2002-2007	M300000 - A299999				18-5244			
350 MAG MPI HORIZON MIE	350/V-8	☛	1999-2001	L304700 - M299999			18-5431	18-5395	18-5438		
350 MAG MPI HORIZON MIE	350/V-8	ESP	2002-2007	M300000 - A089999				18-5244			
350 MAG MPI MIE (GEN +)	350/V-8	ESP	1998	L002008 - L302199	18-5281		18-5405	18-5354	18-5443	18-5494-2ⓐ	18-8832-1
										18-5498-1ⓑ	
350 MAG MPI MIE (GEN +)	350/V-8	☛	1998-2001	L302200 - M299999	18-5273		18-5431	18-5395	18-5438		18-8834-1
350 MAG MPI MIE	350/V-8	ESP	2002-2007	M300000 - A089999				18-5244			18-8828-1
350 MAG MPI SKI	350/V-8	ESP	1995-1998	F350583 - L304599	18-5281		18-5405	18-5354	18-5443	18-5494-2ⓐ	18-8836-1
										18-5498-1ⓑ	
350 MAG MPI SKI (GEN +)	350/V-8	☛	1999-2001	L304600 - M2999999			18-5431	18-5395	18-5438		
350 MAG MPI SKI	350/V-8	ESP	2002-2007	M300000 - A089999				18-5244			18-8828-1
350 MAG SKI	350/V-8	ⓐ, ⓑ	1991-1997	D505450 - K999999			18-5431	18-5395	392-805570A 2		
350MAG BRAVO	V8		1995-1998	F415189 - L325952	18-5281		18-5405	18-5354	18-5443	18-5494-2ⓐ	18-8836-1
MPI &(Gen+)										18-5498-1ⓑ	
350MAG EFI SKI	V8		1996-1997	F820707 - K999999	18-5281		18-5405	18-5354	18-5443	18-5494-2ⓐ	18-8832-1
&(Gen+)										18-5498-1ⓑ	
5.0L Alpha &	V8		1998-2001	L015751 & sup	18-5273		18-5431	18-5395	18-5438	18-5494-2ⓐ	18-8821-1
Bravo(Gen+)										18-5498-1ⓑ	
5.0L EFI (Gen +)	V8		1999-2001	L331631 & sup	18-5273		18-5431	18-5395	18-5438	18-5494-2ⓐ	18-8834-1
										18-5498-1ⓑ	
5.0L MCM/MIE MPI,	V8		2001 & sup	M300000 & SUP	18-5247		18-5245	18-5244	18-5465	18-5351	18-8828-1
198, 898, 5.0L GM	V8		1983-1984	6218462 - 6899057	18-5273		18-5431	18-5395	18-5438	18-5494-2	18-8804-1
(305cid)										18-5498-1	
200, 5.0L GM	V8		1985-1995	6218462 - F600999	18-5273		18-5431	18-5395	18-5438	18-5494-2	18-8804-1
(305cid)										18-5498-1	18-8834-1
200, 5.0L GM	V8		1987-1995	B525982 - F600999	18-5273		18-5431	18-5395	18-5438	18-5494-2	
(305cid)										18-5498-1	
5.7L	350/V-8	ⓐ, ⓑ	1988-2010	6218462 & SUP			18-5431	18-5395			18-8828-1
5.7L EFI	350/V-8	ESP	1995-1997	F225560 - K999999				18-5354			18-8828-1
5.7L EFI (GEN +)	350/V-8	ESP	1998	L010035 - L325976				18-5354	18-5442		
5.7L EFI (GEN +)	350/V-8	ESP	1998	L326000 - L331598				18-5354	18-5442		
5.7L EFI (GEN +)	350/V-8	ESP	1998	L336000 - L339999				18-5354	18-5442		
5.7L EFI (GEN +)	350/V-8	☛	1999	L325977 - L325999			18-5431	18-5395	18-5438		
5.7L EFI (GEN +)	350/V-8	☛	1999	L331599 - L331991			18-5431	18-5395	18-5438		
5.7L EFI (GEN +)	350/V-8	☛	1999	L335716 - L335999			18-5431	18-5395	18-5438		
5.7L EFI (GEN +)	350/V-8	☛	1999-2001	L340000 - M299999			18-5431	18-5395	18-5438		
5.7L EFI MIE (GEN +)	350/V-8	☛	1997	K040300 - K999999					18-5442		
5.7L MIE	350/V-8	ⓐ, ⓑ	1988-2010	B788152 & SUP			18-5431	18-5395			
5.7L MPI HORIZON MIE	350/V-8	ESP	2008-2010	A090000 & SUP				18-5244			18-8821-1
5.7L MPI MIE	350/V-8	ESP	2008-2010	A090000 & SUP				18-5244			
5.7L MPI SKI	350/V-8	ESP	2008-2010	A090000 & SUP				18-5244	18-5433		18-8821-1
5.7L SKI	350/V-8	ⓐ	1985-1995	A338553 - F775199	18-5251 ★	18-5314	18-5404-1	18-5376	18-5433	18-5494-2ⓐ	18-8802-1
					18-5271 ☞					18-5498-1ⓑ	
5.7L SKI	350/V-8	ⓐ	1985-1996	A338553 - F775199	18-5262 ★	18-5303	18-5403	18-5352	18-5433	18-5494-2ⓐ	18-8802-1
					18-5275 ☞					18-5498-1ⓑ	
5.7L SKI	350/V-8	ⓐ, ⓑ	1987-2010	B514627 & SUP			18-5431	18-5395			
5.7LX	350/V-8	ⓑ	1995-1997	F601000 - K999999			18-5431	18-5395	18-5438		
5.7LX BRAVO EFI (GEN +)	350/V-8	ESP	1996-1997	F800300 - K999999				18-5354			
5.7LX EFI	350/V-8	ESP	1996-1997	F752400 - K999999	18-5281		18-5405	18-5354	18-5442	18-5494-2ⓐ	18-8836-1
										18-5498-1ⓑ	

ⓐ Mallory encendido
 ⓑ Prestolite
 ⓐ Autolite
 ⓐ Mercury encendido
 ⓐ Holley
 ⓐ Thunderbolt IV

☛ Con tornillo bajo la tapa
 ⓐ Delco
 ⓐ Dist. electrónico (rotación std) excluye Thunderbolt encendido
 ⓐ Delco EST
 ⓐ Sistema digital Delco
 ★ Sin tapa dist

☞ Con tapa dist.
 ☛ Mercury HEI
 ESP Delco HEI
 ⓐ Thunderbolt V
 ♥ Prestolite con clip bajo la tapa distribuidor
 ⓐ Controlador contacto dist. (Rotación std.) excl. Thunderbolt enc.

MODELO	Cil.	Tipo encendido	Año	Serie #	Kit encendido	Juego de contactos	Rotor	Dist. tapa	Bobina	Distribuidor	Cables de bujías
5.7L MIE & SKI	V8		1988 & sup	L002003 & sup	18-5273 ★		18-5431	18-5395	18-5438		18-8830-1
5.7L EFI & (Gen+)	V8		1995-1998	F225560-L339999	18-5281 ☞		18-5405	18-5354	18-5442	18-5494-2 Ⓣ	18-8836-1
										18-5498-1 Ⓣ	
5.7L EFI & (Gen+)	V8		1999-2001	L325977 & SUP	18-5273		18-5431	18-5395	18-5438	18-5494-2 Ⓣ	18-8834-1
										18-5498-1 Ⓣ	
5.7L SKI	V8		1987-1997	B514627 - K999999	18-5273		18-5431	18-5395	18-5438	18-5494-2 Ⓣ	18-8821-1
										18-5498-1 Ⓣ	
5.7L SKI	V8		1987-1995	B514627 - F775199	18-5273		18-5431	18-5395	18-5433	18-5494-2 Ⓣ	18-8821-1
										18-5498-1 Ⓣ	
5.7L SKI	V8		1998-2001	L002005 & sup	18-5273		18-5431	18-5395	18-5438	18-5494-2 Ⓣ	18-8821-1
										18-5498-1 Ⓣ	
260, 350MAG	V8		1987-1995	B525982 - F600999	18-5273		18-5431	18-5395	18-5438	18-5494-2	18-8804-1
5.7L SKI/ ALPHA/										18-5498-1	
BRAVO(350cid)											
260, 350MAG,	V8		1987-1995	B525982 - F600999	18-5273		18-5431	18-5395	18-5438	18-5494-2	18-8821-1
5.7L ALPHA/										18-5498-1	
BRAVO(350cid)											
350MAG, 5.7L/	V8		1994-2001	F353525 & SUP	18-5273		18-5431	18-5395	18-5438	18-5494-2	18-8821-1
LX ALPHA &										18-5498-1	
BLACK SCORPION SKI (GEN+)	350/V-8	☞	1996-2003	F800000 - M391599				18-5354	18-5443		18-8832-1
BLACK SCORPION SKI (GEN+)	350/V-8	☞	2003-2007	M391600 - W698432				18-5395			
SCORPION 350	350/V-8	☞	2008-2010	W698433 & SUP				18-5395			
BLACK SCORPION	V8		1996	F800000 - K040000	18-5281		18-5405	18-5354	18-5443	18-5494-2	18-8832-1
SKI(Gen+) (350cid)										18-5498-1	
BLACK SCORPION	V8		1997-1998	K040001 - L005600	18-5281		18-5405	18-5354	18-5443	18-5494-2	18-8824-1
SKI(Gen+) (350cid)										18-5498-1	
BLACK SCORPION	V8		1998-2002	L005601 - M391599	18-5281		18-5405	18-5354	18-5443	18-5494-2	18-8822-1
SKI(Gen+) (350cid)										18-5498-1	
233 MCM & MIE (FORD)	351/V-8	Ⓣ	1975-1977	4173000 - 4902304	18-5260 ★	18-5303	18-5409	18-5352	18-5433	18-5489-2 Ⓣ	18-8803-2
					18-5275 ☞					18-5312-1 Ⓣ	
233 MCM & MIE (FORD)	351/V-8	▼	1975-1977	4173000 - 4902304	18-5258 ★	18-5303	18-5407	18-5369	18-5433	18-5489-2 Ⓣ	18-8803-2
					18-5277 ☞					18-5312-1 Ⓣ	
233 MCM & MIE (FORD)	351/V-8	Ⓣ	1975-1977	4173000 - 4902304	18-5254	18-5317	18-5420	18-5389	18-5433	18-5489-2 Ⓣ	18-8803-2
										18-5312-1 Ⓣ	
255 MCM & MIE	351/V-8		1973-1974	3385721 - 4166999	18-5254	18-5317	18-5420	18-5389	18-5433	18-5489-2	18-8803-2
										18-5312-1	
255 MCM & MIE	351/V-8		1973-1974	3385721 - 4166999	18-5251	18-5314	18-5404-1	18-5376	18-5433	18-5489-2	18-8803-2
					18-5271					18-5312-1	
255 MIE & MCM (FORD)	351/V-8	Ⓣ	1973-1980	3258728 - 5907057		18-5314	18-5404-1		18-5433		
255 MIE & MCM (FORD)	351/V-8	Ⓣ	1973-1980	3258728 - 5907057			18-5420	18-5389	18-5433		
255, 260MCM &	V8		1975-1982	3258728 - 6218461	18-5251	18-5314	18-5404-1	18-5376	18-5433	18-5494-2 Ⓣ	18-8803-2
MIE(350cid)					18-5271					18-5498-1 Ⓣ	
										18-5313-1 Ⓣ	
255MCM & MIE	V8		1975-1980	4498701 - 5907057	18-5254	18-5317	18-5420	18-5389	18-5433	18-5494-2 Ⓣ	18-8803-2
(350cid)										18-5498-1 Ⓣ	
										18-5313-1 Ⓣ	
260,350MAG,	V8		1982-1994	6218462 - F600999	18-5273		18-5431	18-5395	18-5438	18-5494-2 Ⓣ	18-8804-1
										18-5498-1 Ⓣ	
										18-5313-1 Ⓣ	
300, 320EFI	350/V-8		1985-1989	A543604 - C622418	18-5273		18-5431	18-5395	18-5438	18-5494-2 Ⓣ	18-8804-1
										18-5498-1 Ⓣ	
377 MAG	377/V-8	☞	2008-2010	A300000 & SUP				18-5244			
377 SCORPION MCM	377/V-8	☞	1999-2005	L416146 - M907201	18-5281		18-5405	18-5354	18-5443	18-5494-2 Ⓣ	
										18-5498-1 Ⓣ	

- Ⓣ Mallory encendido
- Ⓣ Prestolite
- Ⓣ Autolite
- Ⓣ Mercury encendido
- Ⓣ Holley
- Ⓣ Thunderbolt IV
- ☞ Con tornillos bajo la tapa
- Ⓣ Delco
- Ⓣ Dist. electrónico (Rotación std) excluye Thunderbolt encendido
- Ⓣ Delco EST
- Ⓣ Sistema digital Delco
- ★ Sin tapa dist.
- ☞ Con tapa dist.
- ☞ Mercury HEI
- Ⓣ Delco HEI
- Ⓣ Thunderbolt V
- ▼ Prestolite con clip bajo la tapa distribuidor
- Ⓣ Controlador contacto dist. (Std. Rotation) excl. Thunderbolt enc.

MODELO	Cil.	Tipo encendido	Año	Serie #	Kit encendido	Juego de contactos	Rotor	Dist. tapa	Bobina	Distribuidor	Cables de bujías
377 SCORPION SKI	377/N-8		1997-1998	K000656 - L00314	18-5281		18-5405	18-5354	18-5443	18-5494-2⊕	
										18-5498-1⊕	
MX 6.2L MPI	377/N-8	☛	2000-2001	L680003 - M299999	18-5273		18-5431	18-5395	18-5438	18-5494-2⊕	18-8834-1
										18-5498-1⊕	
MX 6.2L MPI (377CID)	377/N-8	⊕	2002-2007	M300000 - A299999	18-5247		18-5245	18-5244			18-8828-1
MX 6.2L MPI	377/N-8		2001-2004	M300000 & SUP	18-5247		18-5245	18-5244	18-5465	18-5351	18-8828-1
MX 6.2L MPI HORIZON	377/N-8	⊕	2002-2007	M300000 - A299999	18-5247		18-5245	18-5244	18-5465	18-5351	18-8828-1
MX 6.2L MPI HORIZON MIE	377/N-8	⊕	2002-2010	M300000 & SUP	18-5247		18-5245	18-5244	18-5465	18-5351	18-8828-1
MX 6.2L MPI MIE	377/N-8	☛	2000-2001	L670000 - M299999			18-5431	18-5395	18-5438		
MX 6.2L MPI MIE	377/N-8	⊕	2002-2010	M300000 - & SUP				18-5244			18-8828-1
MX 6.2L MPI SKI	377/N-8	⊕	2002-2007	M317000 - A089999	18-5247		18-5245	18-5244			18-8828-1
MX 6.2L BLACK SCORPION SKI	377/N-8	⊕	2001-2003	F800000 - M391599				18-5354			N/D
MX 6.2L BLACK SCORPION SKI	377/N-8	☛	2003-2007	M391600 - W698432				18-5395			
SCORPION 377	377/N-8	☛	2008-2010	W698433 & SUP				18-5395			
325 MCM & MIE	427/N-8	⬆	1969-1974	2278747 & SUP	18-5282		18-5420	18-5389		18-5494-2⊕	18-8803-2
										18-5498-1⊕	
330 MCM & MIE	454/N-8	⊕	1977-1981	4623115-6083144	18-5251 ★	18-5314	18-5404-1	18-5376	18-5433	18-5494-2⊕	18-8803-2
					18-5271 ☞					18-5498-1⊕	
										18-5313-1⊕	
330 MCM & MIE	454/N-8	⬆	1977-1981	4623115-6083144	18-5282		18-5420	18-5389		18-5494-2⊕	18-8803-2
										18-5498-1⊕	
										18-5313-1⊕	
330	454/N-8	⊕	1982-1987	6083145 - B816540			18-5431	18-5395	18-5438		
330, 340, 7.4L	454/N-8		1981-1992	5889914 - D715493	18-5273		18-5431	18-5395	18-5438	18-5494-2⊕	18-8804-1
MCM & MIE(454cid)										18-5498-1⊕	
340 MIE	454/N-8	⊕	1981-1987	5889914 - B788365			18-5431	18-5395	18-5438		
350 MIE	454/N-8	⬆	1974-1976	3780450 - 4623109	18-5282		18-5420	18-5389		18-5494-2⊕	18-8803-2
										18-5498-1⊕	
370 TRS	454/N-8	⊕	1978-1985	4179554 - 6721527	18-5251 ★	18-5314	18-5404-1	18-5376	18-5433	18-5494-2⊕	18-8803-2
					18-5271 ☞					18-5498-1⊕	
										18-5313-1⊕	
370 TRS	454/N-8	⊕	1978-1985	4883520 - 6721527	18-5254	18-5317	18-5420	18-5389	18-5433	18-5494-2⊕	18-8803-2
										18-5498-1⊕	
										18-5313-1⊕	
370 TRS	454/N-8	⊕	1985-1987	6721528 - B714586	18-5273		18-5431	18-5395	18-5433	18-5494-2⊕	18-8804-1
										18-5498-1⊕	
400 TRS	454/N-8	⊕	1980-1986	5668232 - B457644		18-5314	18-5404-1		18-5433		
400 TRS	454/N-8	⊕	1980-1986	5668232 - B457644		18-5317		18-5389	18-5433		
420	454/N-8	⊕	1987-1989	A398941 - B622418	18-5273		18-5431	18-5395	18-5438	18-5494-2⊕	18-8837-1
										18-5498-1⊕	
425	454/N-8	⊕	1990-1993	B622419 - D937011			18-5431	18-5395	18-5438		18-1837-1
440 TRS	454/N-8	⊕	1983-1986	6181070 - B485220		18-5314	18-5404-1		18-5433		
450	454/N-8	⊕	1995-1996	F347100 - F347277	18-5273		18-5431	18-5395	18-5438	18-5494-2⊕	
										18-5498-1⊕	
454 MAG ALPHA	454/N-8	⊕	1986-1997	A631894 - B785148	18-5273		18-5431	18-5395	18-5438	18-5494-2⊕	18-8804-1
										18-5498-1⊕	
454 MAG BRAVO	454/N-8	⊕, ⬆	1988-1997	B721206 - K999999			18-5431	18-5395	18-5438		
454 MAG EFI	454/N-8	⊕	1994-1996	F115700 - F802349				18-5354	18-5443		18-8832-1
454 MAG MPI	454/N-8	⊕	1996-1998	F802350 - L085009				18-5354	18-5443		18-8832-1
454 MAG MPI	454/N-8	⊕	1998-2001	L085010 - M024999				18-5354	18-5443		18-8832-1
454 MAG MPI HORIZON MIE	454/N-8	⊕	1998-2001	L002200 - L674000	18-5281		18-5405	18-5354	18-5443	18-5494-2⊕	
										18-5498-1⊕	
454-EFI,MAG MPI	454/N-8		1994-2001	F115700 & SUP	18-5281		18-5405	18-5354	18-5443	18-5494-2⊕	18-8832-1
HORIZON MIE										18-5498-1⊕	

⊕ Mallory Encendido
⊕ Prestolite
⊕ Autolite
⊕ Mercury encendido
⊕ Holley
⊕ Thunderbolt IV

⊕ Con tornillo bajo la tapa
⊕ Delco
⊕ Dist. electrónico (Rotación std) excluye Thunderbolt encendido
⊕ Delco EST
⊕ Sistema digital Delco
★ Sin tapa dist.

☞ Con tapa dist
☛ Mercury HEI
⊕ Delco HEI
⬆ Thunderbolt V
♥ Prestolite con clip bajo la tapa distribuidor
⊕ Controlador contacto dist. (Std. Rotation) excl. Thunderbolt enc.

MODELO	Cil.	Tipo encendido	Año	Serie #	Kit encendido	Juego de contactos	Rotor	Dist. tapa	Bobina	Distribuidor	Cables de bujías
454 MAG MPI	454/V-8		1999-2001	L086001 - L674000	18-5281		18-5405	18-5354	18-5443	18-5494-2 Ⓣ	18-8832-1
HORIZON MIE										18-5498-1 Ⓣ	
454 MAG MPI SKI	454/V-8	Ⓢ	1995-1997	F215800 - K999999				18-5354	18-5443		18-8832-1
525 SC	454/V-8	Ⓣ, Ⓢ	1991-1999	D456000 - L415623			18-5431	18-5395			
7.4L BRAVO	454/V-8	Ⓣ, Ⓢ	1988-1997	B771113 - K999999			18-5431	18-5395			
7.4L MIE	454/V-8	Ⓣ, Ⓢ	1988-1997	B788366 - K999999			18-5431	18-5395			
7.4L MPI (L29)	454/V-8	Ⓢ	1998-2001	L010003 - M024330				18-5354	18-5443		18-8832-1
7.4L MPI MIE	454/V-8	Ⓢ	1995-1997	F563052 - K999999				18-5354	18-5443		18-8832-1
7.4L MPI MIE (L29)	454/V-8	Ⓢ	1998-2001	L002006 - L674613				18-5354	18-5443		18-8832-1
7.4L TBI MIE	454/V-8	Ⓢ	1996-1997	F874815 - K999999				18-5354			N/D
7.4LX BRAVO EFI	454/V-8	Ⓢ	1996-1997	F820000 - K999999				18-5354	18-5443		18-8832-1
7.4LX BRAVO MPI	454/V-8	Ⓢ	1996-1997	F602010 - K999999				18-5354	18-5443		18-8832-1
390	482/V-8	Ⓢ	1969-197070	2781129 - 2825059	18-5282		18-5420	18-5389			18-8803-2
460 TRS	482/V-8	Ⓣ	1983-198686	6180970 - 6181046	18-5251	18-5314	18-5404-1	18-5376	18-5433	18-5494-2 Ⓣ	18-8803-2
										18-5498-1 Ⓣ	
										18-5313-1 Ⓢ	
460 TRS	482/V-8	Ⓣ	1983-1986	6180970 - 6181046	18-5254	18-5317	18-5420	18-5389	18-5433	18-5494-2 Ⓣ	18-8803-2
										18-5498-1 Ⓣ	
										18-5313-1 Ⓢ	
465	V8		1992-1994	D763732 - F213244	18-5273		18-5431	18-5395	18-5438		18-8837-1
496 / 8.1L	V8		2000 & sup	M025000 & SUP			N/D				18-8838-1
500	502/V-8	Ⓣ, Ⓢ	1994-1999	F213293 - L601036	18-5273		18-5431	18-5395	18-5438		18-8837-1
500 EFI	502/V-8	Ⓢ	1998-2005	L001477 - M907127				18-5354	18-5443		
502 MAG	502/V-8	Ⓣ	1990-1993	C878221 - F114528	18-5273		18-5431	18-5395	18-5438		18-8804-1
502 MAG EFI	502/V-8	Ⓢ	1993-1996	D840650 - F802599				18-5354	18-5443		18-8832-1
502 MAG MPI	502/V-8	Ⓢ	1996-1998	F802600 - L085000				18-5354	18-5443		18-8832-1
500(Gen+)	502/V-8		1999	L414639 - L601036	18-5273		18-5431	18-5395	18-5438		18-8837-1
500GM EFI	502/V-8		1998-2000	0L001477 & sup	18-5281		18-5405	18-5354	18-5443		
502 MAG MPI	502/V-8		1993-1998	D840650 - L085000	18-5281		18-5405	18-5354	18-5443		18-8832-1
502GM MAG	502/V-8		1998-2001	L085001 & sup	18-5281		18-5405	18-5354	18-5443		18-8832-1
8.2L GM MPI MIE	502/V-8		1996-2001	F819620 & sup	18-5281		18-5405	18-5354	18-5443		18-8832-1
8.2L GM MPI MIE	502/V-8		1990-1996	C878221 - F819619	18-5273		18-5431	18-5395	18-5438		18-8804-1
525 SC	502/V-8		1991-1995	0D456000-0F877734	18-5273		18-5431	18-5395	18-5438		18-8804-1
525 SC	502/V-8		1996-1999	0K000012 & sup	18-5273		18-5431	18-5395	18-5438		18-8837-1
575 SCi	502/V-8	Ⓢ	2000-2005	L306696 - M950526				18-5354	18-5443		
575 SCi	502/V-8		2000-2005	L306696 & SUP	18-5281		18-5405	18-5354	18-5443		
600 SC	502/V-8	Ⓣ, Ⓢ	1991-2000	D456489 - L301186			18-5431	18-5395	18-5438		
600 SC	502/V-8		1991-1993	D456489 - D763875	18-5273		18-5431	18-5395	18-5438		18-8837-1
600 SC	502/V-8		1993-2001	D763876 & SUP	18-5273		18-5431	18-5395	18-5438		18-8837-1
8.2L MIE	502/V-8	Ⓣ, Ⓢ	1990-1996	C878221 - F819619			13524T 1	18-5395	18-5438		
8.2L MPI MIE	502/V-8	Ⓢ	1996-1998	F819620 - L086012				18-5354	18-5443		
8.2L MPI MIE	502/V-8	Ⓢ	1998-2001	L086013 - L674200				18-5354	18-5443		
500 BULLDOG	540/V-8	Ⓣ, Ⓢ	1990-2001	C577003 - M050281	18-5273		18-5431	18-5395	18-5438		18-8837-1
575	540/V-8	Ⓣ	1986-1992	A677429 - D763716			18-5431	18-5395	18-5438		
800 SC	572/V-8	Ⓣ, Ⓢ	1993-1998	D763836 & UP	18-5273		18-5431	18-5395	18-5438		18-8837-1

- Ⓣ Mallory encendido
- Ⓢ Prestolite
- Ⓣ Autolite
- Ⓢ Mercury encendido
- Ⓣ Holley
- Ⓢ Thunderbolt IV
- Ⓣ Con tornillos bajo la tapa
- Ⓢ Delco
- Ⓣ Electronic dist. (std rotation) excluye Thunderbolt encendido
- Ⓢ Delco EST
- Ⓢ Sistema digital Delco
- ★ Sin tapa dist.
- Ⓢ Con tapa dist.
- Ⓢ Mercury HEI
- Ⓢ Delco HEI
- Ⓢ Thunderbolt V
- Ⓢ Prestolite con clip bajo la tapa distribuidor
- Ⓢ Controlador con contacto dist. (Rotación std.) excl. Thunderbolt enc.

PREMIUM MARINE CABLES ENCENDIDO

Los cables de encendido SierraMAGFORCE son "amigos de la electrónica" ya que gracias a su protección todos los dispositivos electrónicos están aislados durante la entrega máxima de voltaje.

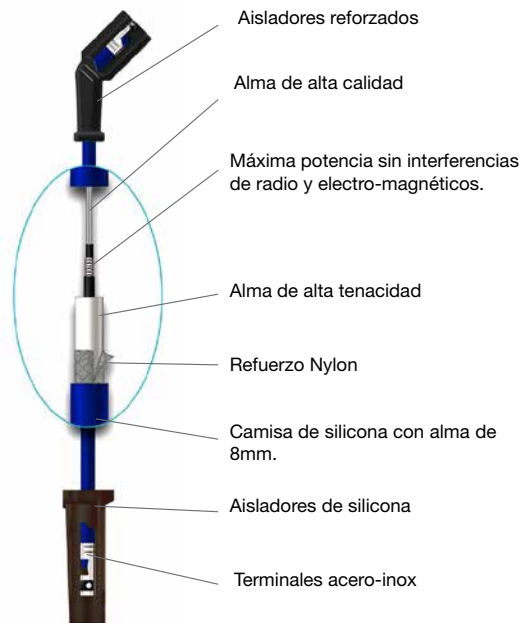

MERCURUISER MARINE APLICACIÓN CABLES ENCENDIDO

Modelo	Cil.	Distribuidor	Año inicial	Año final	Serie # inicial	Serie # final	Juego enchufe cable
110	4	Delco	1963	1966	1537370	2044033	18-8800-1
120	4	Delco	1964	1986	1666601	0B531853	18-8800-1
2.5L	4	Delco	1987	1989	0B531854	0C853255	18-8800-1
140	4	Delco	1968	1986	2508261	0B450800	18-8800-1
3.0L	4	Delco	1987	1989	0B450801	0C856558	18-8800-1
3.0L, LX	4	Prestolite	1990	1991	0C856559	0D504541	18-8800-1
3.0L, LX	4	Delco Digital	1990	1991	0C856559	0D504541	18-8811-1
3.0L	4	Delco EST	1991	& Sup	0D504542	& Sup	18-8833-1
3.0LX	4	Delco EST	1991	1997	0D504542	0K999999	18-8833-1
3.0L MPI	4	Delco EST	2012	& Sup	1A072812	& Sup	18-8833-1
165	4	Delco	1987	1987	0B434940	0B774251	18-8808-2
170	4	Delco	1985	1986	6916779	0B434940	18-8808-2
180	4	Prestolite	1987	1987	0B436391	0B775248	18-8800-1
190	4	Delco	1985	1986	6916779	0B436390	18-8808-2
3.7L	4	Delco	1988	1989	0B774252	& Sup	18-8808-2
3.7LX	4	Delco	1988	1989	0B775249	& Sup	18-8808-2
3.7LX	4	Prestolite	1988	1989	0B775249	& Sup	18-8800-1
470	4	Delco	1976	1984	4208370	6916778	18-8808-2
485	4	Delco	1980	1982	5685394	6218036	18-8808-2
488	4	Delco	1981	1984	6170297	6916778	18-8808-2
140	L6	Delco	1963	1963	1538930	1725960	18-8809-1
150	L6	Delco	1964	1966	1666495	2048046	18-8809-1
160	L6	Delco	1967	1969	2048022	2770031	18-8809-1
165	L6	Delco	1970	1981	2770032	5813433	18-8809-1
200	L6	Delco	1969	1969	2453769	2712072	18-8809-1
185	6	Prestolite	1983	1984	6330183	6919655	18-8801-1
175	6	Thunderbolt IV	1987	1987	0B527955	0B773242	18-8810-1

APLICACIONES CONTINUAN EN LA SIGUIENTE PÁGINA

MERCURUISER MARINE APLICACIÓN CABLES ENCENDIDO

Modelo	Cil.	Distribuidor	Año inicial	Año final	Serie # inicial	Serie # final	Juego enchufe cable
185	6	Thunderbolt IV	1985	1987	6919656	0B527954	18-8810-1
205	6	Thunderbolt IV	1985	1987	0A331445	0B775129	18-8810-1
262 Mag	6	Delco EST	1996	1997	0F803800	0K999999	18-8835-1
4.3L	6	Thunderbolt IV	1988	1996	0B773243	0F802999	18-8810-1
4.3L Alpha	6	Thunderbolt V	1998	& Sup	0L010044	& Sup	18-8810-1
4.3L Bravo	6	Thunderbolt V	1998	& Sup	0L010044	& Sup	18-8810-1
4.3L EFI	6	Delco EST	1998	1998	0L012009	0L359999	18-8835-1
4.3L EFI	6	Thunderbolt V	1999	2004	0L360000	& Sup	18-8810-1
4.3L MPI	6	Delco HVS	2001	& Sup	0M300000	& Sup	18-8829-1
4.3LH Alpha	6	Thunderbolt V	1998	2004	0L010044	& Sup	18-8810-1
4.3LH Bravo	6	Thunderbolt V	1998	2004	0L010044	& Sup	18-8810-1
4.3LX, LXH	6	Thunderbolt IV	1988	1997	0B775130	0K999999	18-8810-1
215 MCM & MIE (Ford)	8	Autolite/Mallory	1970	1972	2781153	3563181	18-8803-2
225 MCM & MIE (Ford)	8	Autolite/Mallory/Mercury	1973	1974	3385721	4166999	18-8803-2
888 (Ford)	8	Autolite/Mallory	1971	1977	3108723	4887829	18-8803-2
190 (GM)	8	Delco	1963	1964	1564539	1730903	18-8803-2
198 MIE	8	Mallory	1977	1977	4776402	4931099	18-8803-2
200	8	Thunderbolt IV	1985	1987	6899058	8774444	18-8821-1
228	8	Mallory	1977	1982	4765100	6218461	18-8803-2
228	8	Thunderbolt IV	1983	1984	6218462	6899268	18-8821-1
228 MIE	8	Mallory	1977	1980	4765100	5907057	18-8803-2
230	8	Thunderbolt IV	1985	1987	6899269	0B773739	18-8821-1
230 MIE (LH)	8	Thunderbolt IV	1981	1987	5907058	0B788151	18-8821-1
230 MIE (RH)	8	Thunderbolt IV	1981	1987	5907058	0B788151	18-8821-1
5.0L	8	Thunderbolt IV	1988	1995	0B774445	0F600999	18-8821-1
5.0L Alpha	8	Thunderbolt V	1998	& Sup	0L015751	& Sup	18-8821-1
5.0L Bravo	8	Thunderbolt V	1998	& Sup	0L015751	& Sup	18-8821-1
5.0L EFI	8	Delco EST	1998	1998	0L012052	0L339999	18-8822-1
5.0L MIE (LH)	8	Thunderbolt IV	1988	1988	0B788152	0C396832	18-8821-1
5.0L MIE (RH)	8	Thunderbolt IV	1988	1988	0B788152	0C396832	18-8821-1
5.0L MPI Alpha	8	Delco HVS	2001	& Sup	0M300000	& Sup	18-8828-1
5.0LX	8	Thunderbolt IV	1988	1995	0B773740	0F600999	18-8821-1
898	8	Mallory	1977	1982	4762210	6218461	18-8803-2
898	8	Thunderbolt IV	1983	1984	6218462	6899057	18-8821-1
225 (GM)	8	Delco	1963	1969	1539620	2694014	18-8803-2
225 MIE (GM)	8	Thunderbolt	1968	1968	2278647	2694014	18-8803-2
250 MCM & MIE	8	Thunderbolt	1968	1969	2314301	2639854	18-8803-2
250	8	Mallory	1977	1977	4768000	4908849	18-8803-2
255 MCM & MIE	8	Mallory	1975	1976	3258728	4501254	18-8803-2
255 MCM & MIE	8	Mercury	1976	1976	4498701	4767999	18-8803-2
255 MIE	8	Mercury	1977	1980	4768000	5907057	18-8803-2
260	8	Mallory	1978	1982	4908850	6218461	18-8803-2
260	8	Thunderbolt IV	1982	1987	6218462	0B773304	18-8821-1
260 MIE (LH)	8	Thunderbolt IV	1981	1986	5907058	0B788151	18-8821-1
260 MIE (RH)	8	Thunderbolt IV	1981	1986	5907058	0B788151	18-8821-1
270 MCM & MIE	8	Thunderbolt	1969	1972	2851074	3385720	18-8803-2
280 TRS	8	Mercury/Mallory	1975	1975	4176250	4499390	18-8803-2
300	8	Thunderbolt IV	1985	1986	6668677	0B430367	18-8821-1
320 EFI	8	Thunderbolt IV	1987	1989	0A543604	0C622418	18-8821-1
350 Mag Alpha	8	Thunderbolt IV	1986	1994	0A635178	0F353690	18-8821-1
350 Mag Alpha	8	Thunderbolt V	1995	1997	0F353691	0K999999	18-8821-1
350 Mag Alpha EFI	8	Delco EST	1996	1997	0F800300	0K999999	18-8822-1

APLICACIONES CONTINUAN EN LA SIGUIENTE PÁGINA

MERCRUISER MARINE APLICACIÓN CABLES ENCENDIDO

Modelo	Cil.	Distribuidor	Año inicial	Año final	Serie # inicial	Serie # final	Juego enchufe cable
350 Mag Bravo MPI	8	Delco EST	1995	1996	0F415189	0K999999	18-8822-1
350 Mag EFI Ski	8	Delco EST	1994	1997	0F215561	0K999999	18-8822-1
350 Mag MPI	8	Delco EST	1998	1998	0L010019	0L325952	18-8822-1
350 Mag MPI Alpha	8	Delco HVS	2001	& Sup	0M300000	& Sup	18-8828-1
350 Mag MPI Bravo	8	Delco HVS	2001	& Sup	0M300000	& Sup	18-8828-1
350 Mag MPI Horizon	8	Delco HVS	2001	& Sup	0M300000	& Sup	18-8828-1
350 Mag MPI Horizon MIE	8	Delco HVS	2001	& Sup	0M300000	& Sup	18-8828-1
350 Mag MPI MIE	8	Delco HVS	2001	& Sup	0M300000	& Sup	18-8828-1
350 Mag MPI Ski	8	Thunderbolt IV	1991	1996	0D505450	0K40399	18-8821-1
350 Mag MPI Ski	8	Thunderbolt V	1991	1997	0D505450	0K999999	18-8821-1
5.7L Alpha	8	Thunderbolt IV	1988	1995	0B773305	0F600999	18-8821-1
5.7L Alpha	8	Thunderbolt V	1996	1997	0F601000	& Sup	18-8821-1
5.7L Bravo	8	Thunderbolt IV	1988	1993	0B773305	0F353524	18-8821-1
5.7L Bravo	8	Thunderbolt V	1994	& Sup	0F353525	& Sup	18-8821-1
5.7L EFI	8	Delco EST	1995	1998	0F225560	0L339999	18-8822-1
5.7L EFI MIE	8	Delco EST	1997	1997	0K040300	0K999999	18-8822-1
5.7L MIE	8	Thunderbolt IV	1988	1995	0B788152	0F746099	18-8821-1
5.7L MIE	8	Thunderbolt V	1996	1997	0F622100	0K999999	18-8821-1
5.7L MIE	8	Thunderbolt V	1998	& Sup	0L002003	& Sup	18-8821-1
5.7L Ski	8	Mallory/Prestolite	1985	1995	0A338553	0F775199	18-8802-1
5.7L Ski	8	Thunderbolt IV	1987	1995	0B514627	0F775199	18-8821-1
5.7L Ski	8	Thunderbolt V	1996	1997	0F775200	0K999999	18-8821-1
5.7L Ski	8	Thunderbolt V	1998	& Sup	0L002005	& Sup	18-8821-1
5.7LX Alpha & Bravo	8	Thunderbolt V	1996	1997	0F601000	0K999999	18-8821-1
5.7LX Bravo & EFI	8	Delco EST	1996	1997	0F752400	0K999999	18-8822-1
233 MCM & MIE (Ford)	8	Mercury/Prestolite	1975	1977	4173000	4902304	18-8803-2
255 MCM & MIE (Ford)	8	Mercury/Mallory	1973	1980	3258728	5907057	18-8803-2
MX 6.2L MPI	8	Delco HVS	2001	& Sup	0M300000	& Sup	18-8828-1
MX 6.2L MPI Horizon	8	Delco HVS	2001	& Sup	0M300000	& Sup	18-8828-1
MX 6.2L MPI Horizon MIE	8	Delco HVS	2001	& Sup	0M300000	& Sup	18-8828-1
MX 6.2L MPI MIE	8	Delco HVS	2001	& Sup	0M300000	& Sup	18-8828-1
377 MAG MPI BRAVO	8	Delco HVS	TODOS	TODOS	1A300000	& Sup	18-8828-1
325 MCM & MIE	8	Thunderbolt	1969	1974	2278747	& Sup	18-8803-2
325 MCM & MIE	8	Mallory	1969	1972	2278747	& Sup	18-8803-2
390	8	Mallory	1968	1970	TODOS		18-8803-2
330	8	Mallory	1977	1981	4623115	6083144	18-8803-2
330	8	Thunderbolt	1977	1981	4623115	6083144	18-8803-2
330	8	Thunderbolt IV	1982	1987	6083145	0B816540	18-8821-1
340 MIE	8	Thunderbolt IV	1981	1987	5889914	0B788365	18-8821-1
350 MIE	8	Thunderbolt	1974	1976	3780450	4623109	18-8803-2
370 TRS	8	Mallory/Holley	1978	1985	4179554	6721527	18-8803-2
370 TRS	8	Thunderbolt IV	1985	1987	6721528	0B714586	18-8821-1
400 TRS	8	Mallory/Holley	1980	1986	5668232	0B457644	18-8803-2
440 TRS	8	Mallory/Holley	1983	1986	6181070	0B485220	18-8803-2
450	8	Thunderbolt IV	1995	1996	0F347100	0F347277	18-8821-1
454 Mag Alpha	8	Thunderbolt IV	1986	1988	0A631894	0B785148	18-8821-1
454 Mag Bravo	8	Thunderbolt IV	1988	1997	0B721206	0K999999	18-8821-1
454 Mag EFI	8	Delco EST	1994	1996	0F115700	0F802349	18-8822-1
454 Mag MPI	8	Delco EST	1996	2001	0F802350	M024999	18-8822-1
454 Mag MPI Horizon MIE	8	Delco EST	1999	2001	0L002200	0L674000	18-8822-1
454 Mag MPI Ski	8	Delco EST	1995	1997	0F215800	0K999999	18-8822-1
7.4L Bravo I, II, III	8	Thunderbolt IV	1988	1997	0B771113	0K999999	18-8821-1

APLICACIONES CONTINUAN EN LA SIGUIENTE PÁGINA

MERCURUISER MARINE APLICACIÓN CABLES ENCENDIDO

Modelo	Cil.	Distribuidor	Año inicial	Año final	Serie # inicial	Serie # final	Juego enchufe cable
7.4L Bravo III	8	Thunderbolt V	1992	1997	603118	0K999999	18-8821-1
7.4L EFI MIE	8	Thunderbolt IV	1988	1996	0B788366	0F820141	18-8821-1
7.4L MIE	8	Thunderbolt IV	1988	1996	0B788366	0F820141	18-8821-1
7.4L MIE	8	Thunderbolt V	1992	1997	0D715494	0K999999	18-8821-1
7.4L MPI (L29)	8	Delco EST	1998	2001	0L010003	0M024330	18-8822-1
7.4L MPI MIE	8	Delco EST	1995	2001	0F563052	0M025999	18-8822-1
7.4LX Bravo EFI & MPI	8	Delco EST	1996	1997	0F602010	0K999999	18-8822-1
390	8	Thunderbolt	1969	1970	2781129	2825059	18-8803-2
460 TRS	8	Mallory/Holley	1983	1986	6180970	6181046	18-8803-2
460 Ciclon	8	TODOS	1983	1985	TODOS		18-8803-2
496 Mag & Mag HO	8	Delco (coil over plug)	2000	& Sup	0M025000	& Sup	18-8838-1
8.1 MIE & HO MIE	8	Delco (coil over plug)	2000	& Sup	0M025000	& Sup	18-8838-1
502 Mag Bravo	8	Thunderbolt IV	1990	1993	0G878221	0F114528	18-8821-1
502 Mag EFI	8	Delco EST	1993	1996	0B40650	0F802599	18-8822-1
502 Mag MPI	8	Delco EST	1996	2001	0F802600	0M024999	18-8822-1
525 SC	8	Thunderbolt IV	1991	1995	0D456000	0F877734	18-8821-1
8.2L MIE	8	Thunderbolt IV	1990	1996	0C878221	0F819619	18-8821-1
8.2L MPI MIE	8	Delco EST	1996	2001	0F819620	0L674200	18-8822-1



**18-5225
KIT CABLES BUJÍAS**
Reemplaza: Mercury 84-99215A26, 84-813706A26, 84-93475A26, 84-93212A1, 84-90816A26
Kit incluye 25 pies de cable de encendido de 7 MM hypalon con alma metálica y un amplio surtido de 3 tipos de terminales para fuer-abordas.



**18-5226
CABLE ENCENDIDO**
Alma metálica
100' bobina
7mm Hypalon



CABLES BATERIA

Ref No.	talla	Color	Calibre	Ref No.	talla	Color	Calibre
BC88523	2'	rojo	4	BC88563	6'	rojo	2
BC88533	2'	negro	4	BC88573	6'	negro	2
BC88543	4'	rojo	2	BC88583	8'	rojo	1
BC88553	4'	negro	2	BC88593	8'	negro	1

Terminales soldados para terminal de 3/8"

Pack de 10



**18-5224
18-5224-9①**
TERMINAL CABLE BUJÍAS
Reemplaza: 20121, 8M0084600

Pack de 10



**18-5750
18-5750-9①**
TAPA BUJÍAS UNIVERSAL
Suministrado con conector terminal completo



**18-5752
TAPA BUJIAS UNIVERSAL**
8mm



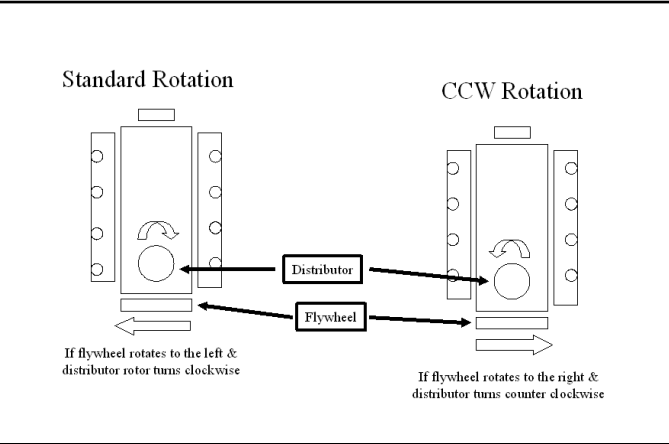

18-6275
ARRANQUE
Reemplaza:
50-807904A1, 50-863007A1, 50-864340A2, 50-806964A4, 50-806964A3, 50-806964A2, 50-812604A2, 50-812428A3, 50-812428A3, 50-12177A2, 50-12121A2, 50-822330A2, 814472, 50-99418A2, 50-77328A3, 50-77328A1

- Engranaje magnético permanente
- Intraborda
- 2 tornillos
- Rotación CW • SAE J1171

Use con último modelo motores 3.0L con 14" volante
Para : Volvo Penta, Mercruiser, Marine Power
Use Solenoide 18-5811



18-5913
ARRANQUE
 (Sentido reloj)
 Delco magnético permanente 2 tornillos
 12V - 11 dientes - tornillos desplazados
 Para: Último modelo GM - 14" volante
 Reemplaza: 50-812428A3, 50-812604A2,
 50-822330A2, 50-864340A2
 Incluye 18-8402 (2) tornillos
 Reemplaza Solenoide: 18-6287
SAEJ1171 PARA: 4.3L (1996 & SUP); 5.0 & 5.7L (1998 & SUP)



18-5919
ARRANQUE
 magnético permanente I/O starter, 11 dientes
 Reemplaza: 50-806963A4, 50-806965A2, 50-806965A4
 Solenoide de recambio: 18-6287
 Incluye 1 tornillo 18-8402 y 1 tornillo 18-8404
 Para: Motores chevy con volante de 12 3/4"
 SN-OF803000AN/OF803114AN 4.3LX/LXH Alpha/Bravo 262 CID
 SN-355305AN/22560AN 5.7L Alpha (EFI)/5.7L Bravo (EFI)
SAEJ1171



18-5910
ARRANQUE
 (Heavy-Duty) (Giro agujas del reloj) (9 dientes) bloque pequeño V-6 & V-8 GM motores con volante de 14 1/4". Para motores con rotación estándar.
 Reemplaza: 50-12177A2, 50-99418A2



18-5908
ARRANQUE
 (Heavy-Duty) (Giro contrario a las agujas del reloj) (9 dientes)
 Montaje superior, entrada posterior motores GM & Ford. Para motores rotación estándar.
 Reemplaza: 50-76965A3, 50-808011A1, 50-808011A05, 50-808011A4, 50-808011A3, 50-99419A3, 50-76967A4, 50-76967A1
 50-65784A1, 50-47455, 50-17251A3, 50-17251A2
 Reemplaza Solenoide: 18-5837
SEAJ1171





18-5903
ARRANQUE
 (Giro agujas del reloj) Montaje inferior, dos tornillos, para motores ford rotación estándar.
 Reemplaza: 50-69865A1, 50-12872, 50-56886
 Reemplaza Solenoide: 18-5801
 *Para tipo PMGR style order 18-5923



18-6870
ARRANQUE
 Reemplaza: Mercury 50-805833, T
 Para: D7.3L D-tronic 260 LD, 300 año 1999



18-6946
ARRANQUE
 Reemplaza: 50-8m8021116
 Para: Alto rendimiento de arranque de 11 dientes para 6.2L &Amp; Escorpión 8.9L HO aplicaciones



18-6947
ARRANQUE
 Reemplaza: Mercruiser 50-805991
 Para: 7.3L (BRAVO & MIE) DIESEL NAV 444 V-8 1994-1996



18-6949
ARRANQUE
 Reemplaza: Mercruiser 50-831001562, 50-831001961
 Para: WO4CTA (150 HP) HINO 234 I/L4, WO4CTI (210 HP) HINO 234 I/L4



18-6957
ARRANQUE
 Reemplaza: Mercruiser 50-801333980, 50-854178, 50-855507



18-8412
EXTENSIÓN TORNILLO ARRANQUE
 Alarga la conexión del solenoide que requiere más conexiones.



18-2434
ALOJAMIENTO
 Reemplaza: 814309A1
 Para: GM V-8's bloques grandes y pequeños intraborda/modelos ski

TORNILLOS ARRANQUE



Descripción	Mercruiser #	Ref #
Tornillo arranque 3/8 - 16 - 4 3/8 Largo	10-8053432	18-8402
Tornillo arranque 3/8 - 16 - 1 13/16 Largo	10-8053433	18-8403
Tornillo arranque 3/8 - 16 - 1 11/16 Largo	10-8083434	18-8404-1



18-5717
JUEGO ESCOBILLA
Reemplaza: 33270

18-5804
SOLENOIDE
Reemplaza: 13037
Delco



18-5837
SOLENOIDE
Reemplaza: 89-99253, 89-18080, 89-89902, 89-33316, 89-60687
Delco



18-5838
SOLENOIDE
Reemplaza: 33261, 89902
Delco



18-5840
SOLENOIDE
Prestolite 15-79,
SAW 4201, SAW4207, SAW4210



APLICACIONES JUEGO ESCOBILLAS/INTERRUPTOR DE ARRANQUE

Años	Volt.	Arranque No.	Juego Escobillas	Interruptor arranque	Años	Volt.	Arranque No.	Juego escobillas	Interruptor Arranque
1977-82	12	1108755	18-5717	18-5838	1971-78	12	TODOS	18-5717	18-5838
1977-82	12	1108756	18-5717	—	1969-78	12	MEO-7003	—	18-5840
1977-82	12	1109484,5,6	18-5717	18-5838					

① **18-5801D**

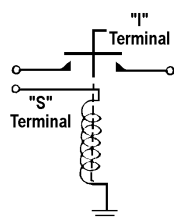

18-5801
SOLENOIDE
Reemplaza: 89-76416A1

① **18-5802D**

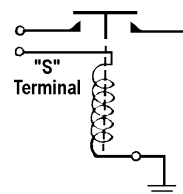

18-5802
SOLENOIDE
Base tierra
Reemplaza: 65057A1, 65057T1, 65057, 54981

① Referencias acabadas en "D" envasadas - Referencias normales no envasadas

① **18-5810D** 

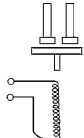



18-5810
SOLENOIDE

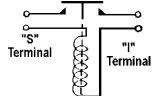

18-5811
ARRANQUE SOLENOIDE
Reemplaza: 809463A1, 8094631, 809463, 8094621, 809462
Para: PG 260 Serie arranque, GM V6 & V8 (1983-Sup)

① **18-5815D** 

18-5815
SOLENOIDE
Reemplaza: 89-68258A4, 89-853654A1, 89-76545, 89-76545T, 89-65258, 89-61053, 89-15857

① **18-5816D** 



18-5816
SOLENOIDE
Reemplaza: 89-96054, T, 89-91975
(Soporte plano)

① **18-5817D** 

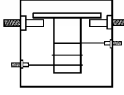



18-5817
SOLENOIDE
Reemplaza: 89-96158, 89-96158T, 94318, 846070
(Soporte curvado)

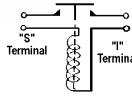

18-5820
SOLENOIDE
Reemplaza: 89-818999A2, 89-825842A1, 89-850188T1

① **18-5836D** 

18-5836
SOLENOIDE
Reemplaza: 25661, 256611, 25661T1



18-9802
Luz cronometraje
Para más de 10,000 RPM's



18-6749
SOPORTE TRIM
Soporte metálico
Reemplaza: 862548A1, 42419A1, 88893A4, 88553A1, 862548A1, 58397A3, 58397A2, 42419A1
Para: Soporte de montaje al suelo MerCruiser



18-6750
SOPORTE TRIM
Acero inox
Reemplaza: 862548A1, 42419A1
Para: Soporte de montaje al suelo MerCruiser



18-6747
TILT/ TRIM
Reemplaza: 865380A25, 865380A15, 865380A05, 865380A02, 14336A28, 14336A22, 14336A17, 14336A15, 14336A9, 14336A6, 88183A12, 88183A3
Para último modelo aplicaciones colas



18-6752
BOMBA HIDRÁULICA TRIM
Baja presión - Caudal alto
Soporte metálico
Reemplaza: 14336A9, 88183A12, 96477A3, 88183A11, 88183A6, 865380A25, 865380A15, 865380A05, 865380A02, 14336A28, 14336A22, 14336A17, 14336A15, 14336A6
Para: 1983 y último sin "Conector rápido"
Reemplaza Motor: 18-6772
Fusibles 20 amp



18-6753
BOMBA HIDRÁULICA TRIM
Baja presión - Caudal alto
Soporte acero inox
Reemplaza: 14336A9, 88183A12
Para: 1983 y último sin "quick connect"
Reemplaza Motor: 18-6772
Fusibles 20 amp

① Referencias acabadas en "D" envasadas - Referencias normales no envasadas

APLICACIONES EMPIEZAN EN LA PÁGINA 406



18-6768
BOMBA POWER TRIM
 Soporte acero
 Reemplaza: 93247A7, 93247A4, 392-8261A1, 392-8263, 88475A4, 79271A4, 74436A9
 Reemplaza bomba de alta presión Prestolite/Sistema de bajo caudal. Utiliza principalmente 1982 y anteriores. Fusibles 20 amp



18-6799
KIT BOMBA POWER TRIM
 Soporte acero inox
 93247A7, 93247A4, 392-8261A1, 392-8263, 88475A4, 79271A4, 74436A9
 Reemplaza bomba para Prestolite alta presión/Sistema caudal bajo. Agua salada. Soporte acero inox. Utiliza principalmente 1982 y anteriores. Fusibles 20 amp.

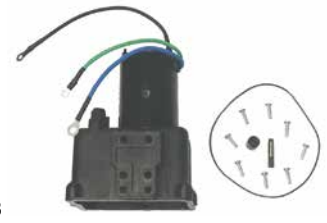

18-6763
MOTOR TILT/TRIM
 Reemplaza: 92975A6, 79271A4, 67914A2, 92975A32, 93247A7
 Para 1984. Para mayoría colas Mercuriser Stern-drives (Motor y solo depósito)
 Para kit reparación use: 18-6253



18-6769-1
BOMBA TILT/TRIM
 Baja presión - Caudal alto
 Reemplaza: 14336A8, 88183A5 From 1984
 Para mayoría colas Mercuriser



18-6772
BOMBA MOTOR TILT
 Reemplaza: 17649, 17649T, 891736T
 Para últimos modelos de Alpha I, Generation II, y dirección Bravo; Primeros modelos de square motores. Colas Mercuriser reemplaza por unidades Oildyne



18-6813
MOTOR TRIM
 Baja presión/Caudal alto
 Reemplaza: 14336A6, A8, A9, A15, A20, 88183A5, A8, A12, 865380A13, A25
 Igual que 18-6769-1, además de cableado
 Reemplaza Solenoide: 18-5817



18-6771
DEPÓSITO TILT/TRIM
 Reemplaza: 18525, 18525A1, 17646



18-6778
TILT/TRIM DEPÓSITO
 Reemplaza: 883166A1, 883166A2
 Para: Motores Tilt con 4 tornillos



18-6823
CABLEADO
 Reemplaza: Universal
 Convierte 3-cable Tilt y Trim
 Motres de 2-cables diseño



18-5872
ARRANQUE
 Reemplaza: 398-6231A10, 6231A6, 6231A5, 6231A4
 Para: 3.7L 1983-89



18-6254
PLATINA CONMUTADOR
 Reemplaza: 392-2940
 Para : Use con bomba Prestolite (Mercury #'s 79271A4 y 88475A5)



18-6253
PLATINA CONMUTADOR
 Use con 18-6763



18-15501
DISYUNTOR
 Reemplaza: 88-93582
 60 AMP



18-6256
KIT MUELLE
 Reemplaza: 392-2529
 Para : Use con bomba Prestolite (Mercury #'s 74436A9, 79271A4, 88475A5 y 93247A4)



18-6255
KIT ESCOBILLAS
 Reemplaza: 392-8989
 Para: Use con bomba Prestolite (Mercury #'s 93247A4)



18-6293
ALTERNADOR
 Reemplaza: 862031T, 862031T1 • SAE J1171
 75I/70 amp, montaje de bisagra, Polea de serpiente 2.44"
 Diametro



18-6298
ALTERNADOR
 Reemplaza: 863077T • SAE J1171
 75I/70 amp, montaje bisagra,
 Polea de serpiente 1.97" Diametro



18-5983
ALTERNADOR
 Reemplaza: 862030T • SAE J1171
 75I/70 amp, montaje bisagra, polea sencilla



18-5956
ALTERNADOR
 (1-cables) (No Core) (68 AMP)
 Se adapta a Mercruiser y muchas otras aplicaciones
 equipado con ventilador y polea.
 Reemplaza: 69729, 90794, 78403A2,
 78403A1, 78477, 59755, 56045
 SAE J1171



18-5957
ALTERNADOR
 (3-Cables) (68 AMP)
 Reemplaza Mando, Motorola y el original Delco. Usa
 las mismas conexiones eléctricas y metodo de mon-
 taje. Equipado con ventilador y polea.
 Reemplaza: 78477, 78403A2, 92497A3,
 78403A1, 90794, 69729, 59755, 56045,
 817119A4, 817119A1, 98555A1, 92497,
 12449A1, 12449
 SAE J1171



18-5946
ALTERNADOR
 (1-Cable) (68 AMP)
 Se adapta a Mercruiser y muchas otras aplicaciones.
 Equipado con ventilador y polea. • SAE J1171



18-5945
ALTERNADOR
 (3-Cables) (68 AMP) • SAE J1171
 Reemplaza Mando, Motorola y el original Delco. Usa
 las mismas conexiones eléctricas y metodo montaje.
 Equipado con ventilador y polea.



18-5960
ALTERNADOR
 Polea de serpiente • 65 Amp
 Reemplaza: 807653T • SAE J1171



18-5966
ALTERNADOR
 Polea de ranura única • 55 Amp
 Reemplaza: 817119A4, 12449A1, 98555A1,
 92497, 817119A1, 12449A1, 12449
 • SAE J1171



18-5967
ALTERNADOR
 Polea de serpiente • 55 Amp
 Reemplaza: 807652T • SAE J1171



18-5965
ALTERNADOR
 65 Amp
 Reemplaza: 817119A1, 817119A4,
 805884T, 98555A1, 92497A3, 92497,
 12449A1, 12449
 SAE J1171



18-6841
ALTERNADOR
 Reemplaza: 56045, 59755, 69729,
 78403A2, 78403A1, 78477, 90794
 Para: Aplicaciones 37-63A Marine



18-6842
ALTERNADOR
 Reemplaza: 56045, 59755, 69729, 78403A2,
 78403A1, 78477, 90794
 Para: Aplicaciones 37-63A Marine



18-6844
ALTERNADOR
 Reemplaza: Mercruiser 834832,
 T2, 857006A3,
 Denso 101211-3460



18-6975
ALTERNADOR (Universal)
 Para: Alternador alto amp 160A,
 montaje universal diseño Delco
 CS1300, correa y polea serpiente
 incluida.



**18-6948
ALTERNADOR**
Reemplaza: 882571, 8M0084523
Para: CMD 1.7 MI 120 I/L4, CMD 1.7 MS 120 I/
L4, D1.7L DTI



**18-6960
ALTERNADOR**
Reemplaza: Mercruiser 821663,
8216631, 821663A1
Denso 101211-3020, 3021



**18-5953-1
KIT CONVERSIÓN ALTERNADOR**
Incluye nuevo 18-5956 68 AMP alternador, soporte montaje 18-5968,
polea (8.0" D.O. x 2.75" H), cableado, tornillería e instrucciones.
Convierte modelo 470 bloque de aluminio con número de serie
4625580 & sup con stator sistema de carga y refrigerado regulador
de voltaje a sistema alternador. **NOTE: Kit fusible 18-8220 (se vende
por separado) se requieren con motores de arranque Delco starters;
Motores de arranque Prestolite con solenoide remoto no requieren
el kit fusible. Compruebe visualmente el motor de arranque antes
de pedirlo.**
Para: Mercruiser 224 / 3.7L



**18-5949
KIT CONVERSIÓN CORREA**
3/8" x 33 1/2"
Reemplaza kit de conversión de correa
de alternador usado en la serie 470
Mercruiser. Incluido en el kit 18-5953-1.



**18-5968
SOPORTE ALTERNADOR**
Reemplaza soporte para alternador kit
conversión Utilizado en la serie 470
Mercruiser incluido en el kit de 18-5953



**18-8220
KIT FUSIBLE**
Reemplaza: 88-79023A91
Para uso con 18-5953 alternador kits
conversión instalado en Mercruiser
(Model 470) 3.7 litros bloques de aluminio
con número de serie 6902288 & sup.
90 AMP



**18-5740
REGULADOR DE
VOLTAJE**
Reemplaza: 42785

Modelo #	Cil.	Años	Desde. S/N	Hasta. S/N	Solenoide	Arranque Remanufacturado	Nuevo arranque	Alternador Remanufacturado	Nuevo Alternador
110	GM 4	1963-1966	1538370	2044033	18-5836	18-5911	18-5911	—	—
120	GM 4	1964-1975	1666601	4469865	18-5836	18-5911	18-5911	18-5957	18-5957
120	GM 4	1976-1982	4469866	6229717	18-5815	18-5911	18-5911	18-5957	18-5957
120 / 2.5L	GM 4	1983-1989	6229718	C853255	18-5817	18-5911	18-5911	—	18-5966 ④
140	GM 4	1968-1975	2508261	4460664	18-5836	18-5911	18-5911	18-5957	18-5957
140	GM 4	1976-1981	4460665	6229717	18-5815	18-5911	18-5911	18-5957	18-5957
140/3.0L	GM 4	1982-1989	6229718	C856558	18-5817	18-5911	18-5911	18-5957	18-5957
140/3.0L	GM 4	1999-2001	OL382122	OM326292	18-5817	—	18-6275	—	18-5983 **
140/3.0L/3.0LX	GM 4	1990-92	C856559	D831100	18-5817	18-5911	18-5911	18-5957	18-5957
140/3.0LX	GM 4	1992-97	D831101	OK999999	18-5817	N/D	18-6275	—	18-5966 ④
165/3.7L	Merc 4	1987-1989	B434941	C762299	18-5802	18-5907	18-5907	N/D	N/D
170	Merc 4	1985-1986	6916779	B434940	18-5802	18-5907	18-5907	N/D	N/D
180/3.7LX	Merc 4	1987-1989	B436391	C762299	18-5802	18-5907	18-5907	N/D	N/D
190	Merc 4	1985-1986	6916779	B436390	18-5802	18-5907	18-5907	N/D	N/D
470	Merc 4	1976-1984	4208730	6916778	18-5802	18-5907	18-5907	N/D	N/D
470MIE	Merc 4	1980-1981	5520115	6218036	18-5802	18-5907	18-5907	N/D	N/D
485	Merc 4	1980-1984	5685394	6916778	18-5802	18-5907	18-5907	N/D	N/D
140	GM 6	1963	1538930	1725960	18-5836	18-5911	18-5911	—	—
150	GM 6	1964-66	1666495	2048046	18-5836	18-5911	18-5911	—	—
160	GM 6	1967-69	2048022	2768031	18-5836	18-5911	18-5911	—	—
160	GM 6	1969	2768032	2770031	18-5836	18-5911	18-5911	18-5957	18-5957
165	GM 6	1970-1975	2770032	4471565	18-5836	18-5911	18-5911	18-5957	18-5957
165	GM 6	1976-1981	4471566	5813433	18-5815	18-5911	18-5911	18-5957	18-5957
200	GM 6	1969	2453769	2712072	18-5836	18-5911	18-5911	—	—
175/4.3L	GM V-6	1987-1992	B527955	D714106	18-5816	—	18-5913	—	18-5966 ④
185	GM V-6	1983-1984	6330183	6919655	18-5816	18-5911	18-5911	—	18-5966 ④
185	GM V-6	1985-1987	A331455	B527954	18-5816	N/D	18-5913	—	18-5966 ④
205	GM V-6	1985-1991	A331455	D714369	18-5816	N/D	18-5913	—	18-5966 ④
262 Mag. EFI	GM V-6	1996-1997	F803800	K999999	18-5817	—	18-5913	—	18-5960
262 Mag. EFI	GM V-6	1996-1997	F803800	K999999	18-5817	N/D	18-5913	—	18-5960
4.3L/LX/LXH	GM V-6	1992-1997	D714107	K999999	18-5817	—	18-5913	—	18-5967
4.3L/LX/LXH	GM V-6	1996-1997	F803000	K999999	18-5817	—	18-5913	—	18-5967
4.3L/LX	GM V-6	1998-99	L010044	OL618999	18-5817	—	18-5913	—	18-5967
4.3L/LH(Gen +)	GM V-6	2000-02	OL619000	OM320024	18-5817	—	18-5913	—	18-6293 **
4.3EFI	GM V-6	1998-99	L012009	OL618999	18-5817	—	18-5913	—	18-5960
4.3L EFI	GM V-6	2000-01	OL619000	OM299999	18-5817	—	18-5913	—	18-6293 **
4.3L MPI	GM V-6	2002	OM300000	OM320024	18-5817	—	18-5913	—	18-6293 **
190	GM V-8	1963-1964	1564539	1730903	18-5836	18-5911	18-5911	—	—
200	GM V-8	1985-1986	6218462	B525981	18-5816	18-5911	18-5911	① ③	18-5966 ④
200	GM V-8	1985-1986	6218462	B525981	18-5816	18-5910	18-5910	② ⑥	18-5966 ④
200/5.0L	GM V-8	1987-1995	B525982	F600999	18-5816	18-5910	18-5910	—	18-5966 ④
200/5.0L	GM V-8	1987-1995	B525982	F600999	18-5817	18-5910	18-5910	—	18-5966 ④
215 MCM & MIE	Ford V-8	1970-1972	2781153	3563181	18-5836	18-5908	18-5908	①	18-5957

① Para volante diámetro 12 3/4"
 ② Para volante diámetro 14"
 ③ Modelos c/magneto permanente use 18-5919
 ④ 55 AMP hasta 65 AMP use 18-5965
 ⑤ Negro
 ⑥ Modelos c/magneto 18-5913
 ⑦ Dirección Bravo
 ⑧ Encendido Firepower
 ⑨ Modulo encendido montado en distribuidor
 ⑩ Modulo encendido montado en codo
 ⑪ Rotación izq.
 ⑫ NLA p/ modelos anteriores a S/N 4167000
 ⑬ PG 260 (9-1/4" largo)
 ⑭ PG260F1 (8-1/2" largo)
 ⑮ Rotación derecha
 ⑯ Encendido estándar
 ⑰ Encendido Thunderbolt
 ⑱ Thunderbolt IV
 ⑲ Thunderbolt V
 ⑳ Modelos transmisión Delco Style

Modelo #	Cil.	Años	Desde. S/N	Hasta. S/N	Solenoides	Arranque remanu	Arranque nuevo	Alternador Remanufact.	Alternador Nuevo
215 MCM & MIE	Ford V-8	1970-1972	2781153	3563181	18-5836	18-5907	18-5907 ⑤	18-5957	18-5957
225	Ford V-8	1973-1974	3385721	4166999	18-5802	18-5903	—	18-5957	18-5957
225 MIE	Ford V-8	1973-1974	3385721	4176999	18-5836	18-5908	18-5908 ①	18-5957	18-5957
225 MIE	Ford V-8	1973-1974	3385721	4176999	18-5836	18-5907	18-5907 ⑤	18-5957	18-5957
888	Ford V-8	1971-1977	3108723	4612109	18-5802	18-5903	—	18-5957	18-5957
888	Ford V-8	1971-1977	4612110	& Sup	18-5801	18-5903	—	18-5957	18-5957
225	GM V-8	1963-1966	1539620	2278646	18-5836	18-5911	18-5911	—	—
225 MIE	GM V-8	1968	2278647	2694014	18-5836	18-5908	18-5908 ①	—	—
225 MIE	GM V-8	1968	2278647	2694014	18-5836	18-5907	18-5907 ⑤	—	—
225	GM V-8	1967-1969	2278647	2694014	18-5836	—	—	—	—
228/230	GM V-8	1977-1986	4765100	B525981	18-5816	18-5911	18-5911 ① ③	—	18-5966 ④
228/230	GM V-8	1977-1986	4765100	B525981	18-5816	18-5910	18-5910 ② ⑥	—	18-5966 ④
228 MIE	GM V-8	1977-1980	4765100	5907057	18-5815	18-5908	18-5908 ①	18-5957	18-5957
228 MIE	GM V-8	1977-1980	4765100	5907057	18-5815	18-5907	18-5907 ⑤	18-5957	18-5957
230/5.0LX	GM V-8	1987-1995	B525982	F600999	18-5816 ⑩	18-5910	18-5910 ③	—	18-5966 ④
230/5.0LX	GM V-8	1987-1995	B525982	F600999	18-5817 ⑨	18-5910	18-5910 ③	—	18-5966 ④
230/5.0L MIE	GM V-8	1987-1988	5907058	B788151	18-5816	18-5908	18-5908 ①	—	18-5966 ④
230/5.0L MIE	GM V-8	1987-1988	5907058	B788151	18-5816	18-5907	18-5907 ⑤	—	18-5966 ④
5.0L(Gen +)	GM V-8	1998-99	L015751	L618999	18-5817	—	18-5913	—	18-5967
5.0L(Gen +)	GM V-8	2000-2002	L619000	M320024	18-5817	—	18-5913	—	18-6293 **
5.0L EFI	GM V-8	1998-99	L012052	L618999	18-5817	—	18-5913	—	18-5960
5.0L EFI	GM V-8	2000-01	L619000	M299999	18-5817	—	18-5913	—	18-6293 **
5.0L MPI	GM V-8	2002	M300000	M320024	18-5817	—	18-5913	—	18-6293 **
198 MIE	GM V-8	1977	4762210	6218461	18-5815	18-5908	18-5908 ①	18-5957	18-5957
198 MIE	GM V-8	1977	4762210	6218461	18-5815	18-5907	18-5907 ⑤	18-5957	18-5957
898	GM V-8	1977-1982	4762210	6218461	18-5801	18-5911	18-5911	18-5957	18-5957
898	GM V-8	1983-1984	621462	B525981	18-5816	18-5911	18-5911 ① ③	—	18-5966 ④
898	GM V-8	1983-1984	621462	B525981	18-5816	18-5910	18-5910 ② ⑥	—	18-5966 ④
233	Ford V-8	1975-1977	4173000	4902304	18-5801	18-5903	—	18-5957	18-5957
233 MIE	Ford V-8	1975-1976	4173000	4775784	18-5836	18-5908	18-5908 ①	18-5957	18-5957
233 MIE	Ford V-8	1975-1976	4173000	4775784	18-5836	18-5907	18-5907 ⑤	18-5957	18-5957
250 MCM & MIE	GM V-8	1968-1969	2314301	2639854	18-5836	18-5908	18-5908 ①	—	—
250 MCM & MIE	GM V-8	1968-1969	2314301	2639854	18-5836	18-5907	18-5907 ⑤	—	—
250	GM V-8	1977	4768000	4908849	18-5801	18-5911	18-5911	18-5957	18-5957
255	Ford V-8	1973-1974	3258728	4175499	18-5802	18-5903	—	18-5957	18-5957
255 MIE	Ford V-8	1973-1974	3258728	4178299	18-5836	18-5908	18-5908 ①	18-5957	18-5957
255 MIE	Ford V-8	1973-1974	3258728	4178299	18-5836	18-5907	18-5907 ⑤	18-5957	18-5957
255	GM V-8	1975-1976	4175500	4767999	18-5815	18-5911	18-5911	18-5957	18-5957
255 MIE	GM V-8	1975-1980	4175500	5907057	18-5815	18-5908	18-5908 ①	18-5957	18-5957
255 MIE	GM V-8	1975-1980	4175500	5907057	18-5815	18-5907	18-5907 ⑤	18-5957	18-5957
260	GM V-8	1978-1982	4908850	6218461	18-5801	18-5911	18-5911	18-5957	18-5957
260	GM V-8	1982-1986	6218462	B525981	18-5816	18-5911	18-5911 ① ③	—	18-5966 ④
260	GM V-8	1982-1986	6218462	B525981	18-5816	18-5910	18-5910 ② ⑥	—	18-5966 ④
260/5.7L	GM V-8	1987-1995	B525982	F600999	18-5816 ⑩	18-5910	18-5910 ⑥	—	18-5966 ④
260/5.7L	GM V-8	1987-1995	B525982	F600999	18-5817 ⑨	18-5910	18-5910 ⑥	—	18-5966 ④
260/5.7L MIE	GM V-8	1987-1995	5907058	F746099	18-5816	18-5908	18-5908 ①	—	18-5966 ④
260/5.7L MIE	GM V-8	1987-1995	5907058	F746099	18-5816	18-5907	18-5907 ⑤	—	18-5966 ④
5.7L/LX	GM V-8	1996	F601000	K001526	18-5817	—	18-5913	—	18-5966 ④
5.7L/LX	GM V-8	1997 & sup	K001527	& sup	18-5817	—	18-5913	—	18-5967
5.7L	GM V-8	2000-02	L619000	M320024	18-5817	—	18-5913	—	18-6293 **
5.7L/LX EFI	GM V-8	1995-1996	F225560	K001505	18-5816	—	18-5913	—	18-5965
5.7L/LX EFI	GM V-8	1997	K001506	K999999	18-5816	—	18-5913	—	18-5960
5.7L EFI	GM V-8	1998 & sup	L010035	& sup	18-5816	—	18-5913	—	18-5960
5.7L EFI	GM V-8	2000-01	L619000	M299999	18-5816	—	18-5913	—	18-6293 **
5.7L MIE	GM V-8	1994-1996	F622151	K040306	18-5816	18-5908	18-5908 ①	—	18-5966 ④
5.7L MIE	GM V-8	1994-1996	F622151	K040306	18-5816	18-5907	18-5907 ⑤	—	18-5966 ④
5.7L MIE	GM V-8	1997 & sup	K040307	& sup	18-5817	18-5908	18-5908	—	18-5967
5.7L MIE	GM V-8	1998-01	L002003	L677226	18-5817	18-5908	18-5908	—	18-6293 **
5.7L EFI MIE	GM V-8	1997	K040300	K999999	18-5816	18-5908	18-5908	—	18-5960
5.7L Ski	GM V-8	1985-1995	A338533	F775199	18-5816	—	18-5913 ⑤	—	18-5966 ④
5.7L Ski	GM V-8	1985-1995	A338533	F775199	18-5816	18-5907	18-5907 ①	—	18-5966 ④
5.7L Ski	GM V-8	1996	F775200	K040003	18-5817	—	18-5913	—	18-5966 ④
5.7L Ski	GM V-8	1997	K040004	K999999	18-5817	—	18-5913	—	18-5967
5.7L Ski	GM V-8	1998 & sup	L002005	& sup	18-5817	—	18-5913	—	18-5967
5.7L Ski	GM V-8	2000-01	L619000	L678784	18-5817	—	18-5913	—	18-6293 **
350 Mag. Alpha	GM V-8	1986-1995	A635178	F600999	18-5816 ⑩	18-5910	18-5910 ⑥	—	18-5966 ④
350 Mag. Alpha	GM V-8	1987-1996	B525982	K001526	18-5817 ⑨	18-5910	18-5910 ⑥	—	18-5966 ④
350 Mag. Alpha	GM V-8	1997	K001527	K999999	18-5817	—	18-5913	—	18-5967
350 Mag. EFI & MPI	GM V-8	1995-1996	F415189	K001500	18-5816	—	18-5913	—	18-5965
350 Mag. EFI & MPI	GM V-8	1997 & Sup	K001501	& sup	18-5816	—	18-5913	—	18-5960
350 Mag MPI	GM V-8	2000-01	L619000	M299999	18-5816	—	18-5913	—	18-6293 **
350 Mag MPI / Horizon	GM V-8	2002	M300000	M320024	18-5817	—	18-5913	—	18-6293 **
350 Mag. MPI MIE	GM V-8	1998 & sup	L002008	& sup	18-5816	18-5908	18-5908	—	18-5960
350 Mag. MPI MIE / Horizon	GM V-8	1999-01	L304700	L678398	18-5816	18-5908	18-5908	—	18-6293 **
350 Mag Ski	GM V-8	1991-1996	D505450	K040399	18-5816 ⑨	—	18-5913	—	18-5966 ④
350 Mag Ski	GM V-8	1991-1996	D505450	K040399	18-5817 ⑧	—	18-5913	—	18-5966 ④
350 Mag Ski	GM V-8	1997	K040400	K999999	18-5817	—	18-5913	—	18-5967
350 Mag EFI Ski	GM V-8	1994-1997	F215561	K999999	18-5816	—	18-5913	—	18-5965
350 Mag MPI Ski	GM V-8	1995-1996	F350583	F799999	18-5816	—	18-5913	—	18-5965
350 Mag MPI Ski	GM V-8	1998 & sup	L002600	& sup	18-5817	—	18-5913	—	18-5960
350 Mag MPI Ski	GM V-8	1998-02	L002600	M310021	18-5817	—	18-5913	—	18-6293 **
Black Scorpion	GM V-8	1996	F800000	K040000	18-5816	—	18-5913	—	18-5965
Black Scorpion	GM V-8	1997 & sup	K040001	& sup	18-5816	—	18-5913 ⑤	—	18-5960

① Para volante diámetro 12 3/4"	⑧ Encendido Firepower encendido	⑥ Rotación derecha
② Para volante diámetro 14"	⑨ Módulo encendido montado en distribuidor	⑦ Encendido estándar
③ Modelos c/magneto permanente use 18-5919	⑩ Módulo encendido montado en codo	⑧ Encendido Thunderbolt
④ 55 AMP hasta 65 AMP use 18-5965	⑪ Rotación izq.	⑨ Thunderbolt IV
⑤ Negro	⑫ NLA p/modelos anteriores S/N 4167000	⑩ Thunderbolt V
⑥ Modelos c/magneto permanente use 18-5913	⑬ PG 260 (9-1/4" largo)	⑪ modelos Transmisión Delco Style
⑦ Dirección bravo	⑭ PG260F1 (8-1/2" largo)	

Modelo #	Cil.	Años	Desde. S/N	Hasta. S/N	Solenoides	Arranque Remanufact.	Nuevo arranque	Alternador Remanufact.	Nuevo Alternador
Black Scorpion	GM V-8	1997 & Sup	K040001	& Sup	18-5816	—	18-5913 ④	—	18-5960
Black Scorpion	GM V-8	1997-01	K040001	L678036	18-5816	—	18-5913	—	18-6293 **
270 MCM & MIE	GM V-8	1969-1972	2851074	3385720	18-5836	18-5908	18-5908 ①	18-5957	18-5957
270 MCM & MIE	GM V-8	1969-1972	2851074	3385720	18-5836	18-5907	18-5907 ⑤	18-5957	18-5957
280 TRS	GM V-8	1975-1976	4176250	4770199	18-5815	18-5911	18-5911	18-5957	18-5957
300 TR TEMPEST	GM V-8	1985-1986	6668677	B430367	18-5816	18-5908	18-5908	—	18-5966 ④
300 MR TEMPEST	GM V-8	1985-1986	6668677	B430367	18-5816	—	18-5919 ①	—	18-5966 ④
300 MR TEMPEST	GM V-8	1985-1986	6668677	B430367	18-5816	—	18-5913 ②	—	18-5966 ④
320 EFI	GM V-8	1987-1989	A543604	C622418	18-5816	—	18-5913	—	18-5966 ④
MX 6.2L MPI	GM V-8	2000-2002	L680003	M320024	18-5817	—	18-5913	—	18-6293
MX 6.2L MPI Horizon	GM V-8	2002	M300000	M320024	18-5817	—	18-5913	—	18-6293
MX 6.2L MPI Horizon MIE	GM V-8	2002	M300000	M310099	18-5817	—	18-5603	—	18-6293
MX 6.2L MPI MIE	GM V-8	2002	M300000	M310099	18-5817	—	18-5603	—	18-6293
MX 6.2L Black Scorpion Ski	GM V-8	2001	L670015	L678036	18-5816	—	18-5913	—	18-6293
325 MCM & MIE	GM V-8	1968-1970	2278747	2761141	18-5836	18-5908	18-5908 ①	—	—
325 MCM & MIE	GM V-8	1968-1970	2278747	2761141	18-5836	18-5907	18-5907 ⑤	—	—
325 MCM & MIE	GM V-8	1970-1974	2761142	3780449	18-5836	18-5908	18-5908 ①	18-5957	18-5957
325 MCM & MIE	GM V-8	1970-1974	2761142	3780449	18-5836	18-5907	18-5907 ⑤	18-5957	18-5957
330	GM V-8	1977-1981	4623115	6083144	18-5836 ⑦	—	18-5913	18-5957	18-5957
330	GM V-8	1977-1981	4623115	6083144	18-5815 ⑧	—	18-5913	18-5957	18-5957
330	GM V-8	1982-1987	6083145	B816540	18-5816	18-5908	18-5908	—	18-5966 ④
330 MIE	GM V-8	1977-1980	4623115	5889913	18-5836 ⑦	18-5908	18-5908 ①	18-5957	18-5957
330 MIE	GM V-8	1977-1980	4623115	5889913	18-5815 ⑧	18-5907	18-5907 ⑤	18-5957	18-5957
340/7.4L MIE w/BW	GM V-8	1981-1992	5889914	D715493	18-5816	18-5908	18-5908 ①	—	18-5966 ④
340/7.4L MIE w/BW	GM V-8	1981-1992	5889914	D715493	18-5816	18-5907	18-5907 ⑤	—	18-5966 ④
7.4L	GM V-8	1988-1991	B771113	D603117	18-5816	18-5910	18-5910 ⑥	—	18-5966 ④
7.4L	GM V-8	1988-1996	B771113	F800699	18-5816 ⑩	18-5910	18-5910 ⑥	—	18-5966 ④
7.4L	GM V-8	1992-1997	D603118	K999999	18-5817 ⑨	—	18-5913	—	18-5966 ④
7.4LX EFI & MPI	GM V-8	1996-1997	F602010	K999999	18-5816	—	18-5913	—	18-5966
7.4L MPI	GM V-8	1998 & Sup	L010003	& Sup	18-5817	—	18-5913	—	18-6293
7.4L MIE	GM V-8	1989-1996	C391564	F820141	18-5816 ⑨	18-5908	18-5908	—	18-5966 ④
7.4L MIE	GM V-8	1992-1997	D715494	K999999	18-5817 ⑨	18-5908	18-5908	—	18-5966 ④
7.4L EFI & MPI MIE	GM V-8	1995-1997	F563052	K999999	18-5816	18-5908	18-5908	—	18-5966
7.4L MPI MIE	GM V-8	1998 & Sup	L002006	& Sup	18-5817	18-5908	18-5908	—	18-6293
350 MIE	GM V-8	1974-1976	3780450	4623109	18-5836	18-5908	18-5908 ①	18-5957	18-5957
350 MIE	GM V-8	1974-1976	3780450	4623109	18-5836	18-5907	18-5907 ⑤	18-5957	18-5957
370 TRS	GM V-8	1978-1985	4179554	6721527	18-5815	18-5908	18-5908	18-5957	18-5957
370 TRS	GM V-8	1978-1985	4179554	6721527	18-5815	18-5908	18-5908	—	18-5966 ④
370 TRS	GM V-8	1985-1987	6721528	B714586	18-5816	18-5908	18-5908	—	18-5966 ④
390 MCM & MIE	GM V-8	1969-1970	2781129	3042731	18-5836	18-5908	18-5908 ①	18-5957	18-5957
390 MCM & MIE	GM V-8	1969-1970	2781129	3042731	18-5836	18-5907	18-5907 ⑤	18-5957	18-5957
400 TRS	GM V-8	1980-1986	4179554	B457644	18-5815	18-5908	18-5908	18-5957	18-5957
400 TRS	GM V-8	1980-1986	4179554	B457644	18-5815	18-5908	18-5908	—	18-5966 ④
420	GM V-8	1987-1989	A398941	B622418	18-5816	18-5908	18-5908	—	18-5966 ④
425	GM V-8	1990-1992	A398941	D937011	18-5816	18-5908	18-5908	—	18-5966 ④
440 TRS	GM V-8	1983-1986	4179554	B485220	18-5815	18-5908	18-5908	18-5957	18-5957
440 TRS	GM V-8	1983-1986	4179554	B485220	18-5815	18-5908	18-5908	—	18-5966 ④
450	GM V-8	1995-1996	F347100	F347277	18-5820	—	18-5913	—	—
454 Mag.	GM V-8	1986-1994	A631894	F304999	18-5816	—	18-5913	—	18-5966 ④
454 Mag.	GM V-8	1995-1997	F305000	K999999	18-5817	—	18-5913	—	18-5966 ④
454 Mag. MPI	GM V-8	1994-1997	F115700	K999999	18-5816	—	18-5913	—	18-5966
454 Mag. MPI	GM V-8	1998 & Sup	L010029	& Sup	18-5816	—	18-5913	—	18-6293
454 Mag. MPI MIE	GM V-8	1996-1997	F820100	K999999	18-5816	—	18-5913	—	18-5966
454 Mag. MPI MIE	GM V-8	1998 & Sup	L002200	& Sup	18-5816	18-5908	18-5908	—	18-6293
454 EFI Ski	GM V-8	1995-1996	F215800	F820099	18-5816	—	18-5913	—	18-5966
460 TRS	GM V-8	1983-1986	4179554	6181046	18-5815	18-5908	18-5908	18-5957	18-5957
460 TRS	GM V-8	1983-1986	4179554	6181046	18-5815	18-5908	18-5908	—	18-5966 ④
465	GM V-8	1990-1994	C849992	F213244	18-5816 ⑨	—	18-5913 ⑦	—	18-5966 ④ ⑤
465	GM V-8	1990-1994	C849992	F213244	—	18-5908	18-5908 ⑩	—	—
500	GM V-8	1994-1997	F213293	& Sup	18-5820	—	18-5913 ⑦	—	—
500	GM V-8	1994-1995	F213293	& Sup	18-5820	18-5908	18-5908 ⑩	—	—
500 Bulldog	GM V-8	1990-1996	C577254	& Sup	18-5820 ⑧	—	18-5913 ⑦	—	—
500 Bulldog	GM V-8	1990-1996	C577254	& Sup	18-5816 ⑧	18-5908	18-5908 ⑩	—	18-5966 ④ ⑤
502 Mag. Bravo	GM V-8	1990-1993	C878221	F114528	18-5816	—	18-5913	—	18-5966 ④
502 Mag. MPI	GM V-8	1993-1997	D840650	K999999	18-5816	—	18-5913	—	18-5966
502 Mag. MPI	GM V-8	1998 & Sup	L017000	& Sup	18-5816	—	18-5913	—	18-6293
525 SC	GM V-8	1991-1993	D456000	D763831	18-5816	—	18-5913 ⑦	—	18-5966 ④ ⑤
525 SC	GM V-8	1991-1993	D456000	D763831	18-5816	18-5908	18-5908 ⑩	—	—
525 SC	GM V-8	1993-1997	D763871	& Sup	18-5820	—	18-5913 ⑦	—	18-5966 ④ ⑤
525 SC	GM V-8	1993-1997	D763871	& Sup	18-5820	18-5908	18-5908 ⑩	—	—
525 EFI	GM V-8	2003-2010	M900146	& Sup	—	—	—	—	18-6298
575	GM V-8	1986-1992	A677429	D763716	18-5816	18-5908	18-5908	—	18-5966 ④
600 SC	GM V-8	1991-1996	D456489	F877642	18-5816 ⑧	18-5908	18-5908	—	18-5966 ④ ⑤
600 SC	GM V-8	1991-1996	D456489	F877642	18-5820 ⑧	18-5908	18-5908	—	—
600 SC	GM V-8	1997	K000227	& Sup	18-5820	—	18-5913 ⑩	—	—
600 Sci	GM V-8	2005-2010	M952908	& Sup	—	—	—	—	18-6298
800 SC	GM V-8	1993-1996	D763836	& Sup	18-5820	18-5908	18-5908 ⑩	—	—
8.2L MIE	GM V-8	1990-1996	C878221	F819619	18-5816 ⑨	18-5908	18-5908	—	18-5966 ④
8.2L MIE	GM V-8	1993-1996	D857200	F819619	18-5817	18-5908	18-5908	—	18-5966 ④
8.2L MPI MIE	GM V-8	1996-1997	F819620	K999999	18-5816	18-5908	18-5908	—	18-5966
8.2L MPI MIE	GM V-8	1998 & Sup	L002450	& Sup	18-5816	18-5908	18-5908	—	18-6293

- ① Para volante diámetro 12 3/4"
- ② Para volante diámetro 14"
- ③ Modelos c/magneto permanente use 18-5919
- ④ 55 AMP hasta 65 AMP use 18-5965
- ⑤ Negro
- ⑥ Modelos c/magneto 18-5913
- ⑦ Dirección Bravo

- ⑧ Encendido Firepower
- ⑨ Modulo encendido montado en distribuidor
- ⑩ Modulo encendido montado en codo
- ⑪ Rotación izq.
- ⑫ NLA p/modelos anteriores S/N 4167000
- ⑬ PG 260 (9-1/4" largo)
- ⑭ PG260F1 (8-1/2" largo)

- ⑮ Rotación derecha
- ⑯ Encendido estándar
- ⑰ Encendido Thunderbolt
- ⑱ Thunderbolt IV
- ⑲ Thunderbolt V
- ⑳ Modelos transmisión
- ** Delco Style

18-7683
REGULADOR DE PRESIÓN COMBUSTIBLE
 Reemplaza: 849899
 Para: MCM 500 EFI

18-7663
REGULADOR DE PRESIÓN COMBUSTIBLE
 Reemplaza: 802630T01, 802630001, 802630T, 802630, 8M0069803
 7.4L MPI (L29)

18-33207
REGULADOR DE PRESIÓN COMBUSTIBLE
 Reemplaza: 860349A1
 Para: MCM/MIE 7.4L/LX MPI, 4545 Mag MPI, 502 Mag MPI, MIE 8.2L MPI.

18-33211
REGULADOR DE PRESIÓN COMBUSTIBLE
 Reemplaza: 892681
 Para: Mercruiser 8.1L, 496 Mag HO, 502 Mag MPI 375-400 HP.

18-7600
SENSOR DE TEMPERATURA
 Reemplaza: 805218T

18-7700
SENSOR POSICIÓN ACELERADOR
 Reemplaza: 853678T
 Para: MCM/MIE 4.3L MPI, 5.0L MPI, MX6.2L MPI w/ECM 555 and 350 Mag MPI, Black Scorpion Tow Sports, 377 Scorpion Tow Sports, 7.4L MPI(L29) & MCM 496 Mag & HO y MIE 8.1S & HO

18-7630
SENSOR POSICIÓN ACELERADOR
 Reemplaza: 805226A1

18-7701
CONTROL MOTOR
 Reemplaza: 862998
 Para: MCM 3.0L MPI, V6 & V8(305, 350 & 496 cid) MPI motores con ECM555 (Incluye juntas)

18-7697
IAC MOTOR
 Reemplaza: 803149
 Para: MCM/MIE 350 Mag MPI, Black Scorpion Tow Sports, 377 Scorpion MCM & Tow Sports, MX6.2L MPI, 7.4L MPI(L29) & 575 Sci

18-7632
CONTROL MOTOR RELANTI
 Reemplaza: 805224A1

18-33800
PCV VÁLVULA
 Reemplaza: 21-806118
 Para: MCM 262 Mag EFI, 4.3L EFI

18-7682
SENSOR DE PICADO
 Reemplaza: 849934, 879150150
 Para: MCM 575 Sci

18-7684
SENSOR DE PICADO
 Reemplaza: 864856A1, 805217A1
 Para: MCM/MIE GM V6 & V8 (350, 377, 454 & 502cid)EFI

18-7660
SENSOR DE PICADO
 Reemplaza: 881731, 8M0054726
 V-6 & V-8 MPI motores con 555 ECM

18-7550
SENSOR DE PICADO
 Reemplaza: 861249, 861249A1
 Para: MERCURY 5.7L, 7.4L 1998-2001



18-7551
SENSOR MAP
 Reemplaza: 861425
 Para: Mercury Scorpion,
 Escorpión negro 1998-2010



18-7668
MAP SENSOR
 Reemplaza: 854445
 525 EFI



18-7553
SENSOR DE GOLPE
 Replaces: 808015T
 Para: Mercury 5.7L MAG 1998-2010



18-7554
SENSOR DE GOLPE
 Reemplaza: 878187
 Para: Mercury 5.7L MAG 1994-2010



18-7677
SENSOR DE GOLPE
 Reemplaza: 806612T
 Para: GM V8(305, 350 & 377 cid)



18-7703
SENSOR DE GOLPE
 Reemplaza: 805544T



18-7646
SENSOR ARBOL DE LEVAS
 Reemplaza: 892615002, 892615001,
 862615



18-7685
INYECTOR TBI
 Reemplaza: 852956A1
 Para: MCM GM V6 & V8 (305 & 350
 cid) motores TBI



18-7757
**SENSOR POSICIÓN ACELERA-
 DOR** Reemplaza: 803148
 Para: 350 Mag OL005900 & sup



18-33104
INYECTOR COMBUSTIBLE
 Reemplaza: 802632T, 802632
 Para: MCM/MIE 7.4L MPI L29



18-7688
INYECTOR COMBUSTIBLE
 Reemplaza: 885176
 Para: Motores MCM 4.3L MPI (s/n OM300000-1A063239)
 & 5.0L, 5.7L & 6.2L MPI motores con ECM 555
 (s/n OM300000-1A064824)



18-7698
INYECTOR COMBUSTIBLE
 Reemplaza: 881693002
 Para: MCM 496 Mag & HO y MIE 8.1S & HO

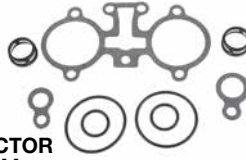

**18-7690
KIT RETÉN INYECTOR**
Use con inyector Mercury # 852956A1, 853998A1, 853998T, 853998
Para: 262 Mag EFI (1996-97), 4.3L EFI (1998-01), 5.0L EFI (1998-01), 350 Mag Alpha EFI (Gen+) (1996-97), 350 Mag EFI SKI (1994-97), 5.7L EFI (1995-01), 5.7L EFI MIE (Gen+) (1997), 5.7L LX Bravo EFI (Gen+) (1996-97), 5.7 LX EFI (1995-97), 7.4L LX TBI (1996-97), 575 Sci (2000-05)



**18-7691
KIT RETÉN INYECTOR**
Use con Mercury Inyector # 806807A1
Para: 350 Mag Bravo MPI (1995-96), Black Scorpion SKI (1996)



**18-7692
KIT RETÉN INYECTOR**
Use con inyector Mercury # 861260T, 861260
Para: 350 Mag MPI(98-01), 350 Mag MPI Horizon MIE(99-01), 350 Mag MPI MIE(98-01), 350 Mag MPI SKI(98-01), MX 6.2L MPI(00-01), 454 Mag MPI(99-01), 454 Mag MPI Horizon MIE(99-01), 502 Mag MPI(99-01), 8.2L MPI(99-01)



**18-7693
KIT RETÉN INYECTOR**
Use con inyector Mercury # 802632T, 849896
Para: 7.4L MPI(L29)(98-01), 7.4L MPI MIE(L29)(98-01), 500 EFI(99-05)



**18-7694
KIT RETÉN INYECTOR**
Use con inyector Mercury # 881693002
Para: 496 Mag (2001-08), 496 Mag DTS (2001-08), 496 Mag HO (2001-08), 496 Mag HO DTS (2001-08), 8.1L MIE (2001-08), 496 Mag DTS (2001-08), 8.1L HO MIE (2001-08), 496 Mag HO DTS (2001-08)



**18-7695
KIT RETÉN INYECTOR**
Use con inyector Mercury # 885176
Para: 4.3L MPI(02-08), 5.0L MPI(02-08), 5.0L MPI DTS(05-08), 350 Mag MPI(02-08), 350 Mag MPI DTS(05-08), 350 Mag MPI Horizon(02-07), 350 Mag MPI Horizon DTS(05-07), 350 Mag MPI Horizon MIE(02-07), 350 Mag MPI Horizon MIE DTS(05-07), 350 Mag MPI MIE(02-07), 350 Mag MPI MIE DTS(05-07), 350 Mag MPI SKI(02-07), 5.7L Horizon MIE(08), 5.7L MIE(08), 5.7L DTS MIE(08), 5.7L MPI SKI(08), MX6.2L MPI(02-07), MX6.2L MPI DTS(05-07), MX6.2L MPI Horizon(04-07), MX6.2L MPI Horizon DTS(05-07), MX6.2L MPI Horizon MIE(02-08), MX6.2L MPI Horizon MIE DTS(05-08), MX 6.2L MPI MIE(02-07), MX6.2L MPI MIE DTS(05-07), MX6.2L MPI SKI(02-07)



**18-7696
KIT RETÉN INYECTOR**
Use con inyector Mercury # 805225A1
Para: 320 EFI(87-89), 350 Mag Bravo MPI(Gen+)(97), negro Scorpion Ski(97-08), 377 Scorpion MCM(99-05), 377 Scorpion Ski(97-98), MX6.2L Black Scorpion Ski (01-07), 454 Mag EFI SKI(94-97), 454 Mag MPI(96-98), 454 Mag MPI Horizon MIE(98), 7.4L MPI MIE(95-97), 7.4LX MPI(96-97), 502 Mag MPI(93-98), 525 EFI(03-08), 8.2L MPI MIE(96-98)

Aplicaciones Sistema inyección combustible



















Modelo	Litros	CID	# Cil	Intervalo de años	rango de serie	Inyector	IAC Válvula	TPS	F/P regulador montados en riel	F/P Refrigerador regular montado	Sensor de picado
3.0L MPI	3.0L	181	L4	2008-2010	A072812 & SUP	N/D	18-7701	N/D	N/D	N/D	N/D
262 MAG EFI	4.3L	262	V-6	1996-1997	F803800 - K999999	18-7685	18-7632	18-7630	N/D	N/D	18-7684
4.3L EFI	4.3L	262	V-6	1998-2001	L012009 - M299999	18-7685	18-7632	18-7630	N/D	N/D	N/D
4.3L MPI	4.3L	262	V-6	2002-2007	M300000 - A063239	18-7688	18-7701	18-7700	N/D	N/D	N/D ②
4.3L MPI	4.3L	262	V-6	2007-2010	A063240 & SUP	N/D	18-7701	18-7700	N/D	N/D	N/D ②
5.0L EFI	5.0L	305	V-8	1998-2001	L012052 - M299999	18-7685	18-7632	18-7630	N/D	N/D	N/D
5.0L MPI	5.0L	305	V-6	2002-2007	M300000 - A064824	18-7688	18-7701	18-7700	N/D	N/D	N/D ②
5.0L MPI	5.0L	305	V-6	2007-2010	A064825 & SUP	N/D	18-7701	18-7700	N/D	N/D	N/D ②
5.0L MPI DTS	5.0L	305	V-8	2005-2007	W310000 - A064824	18-7685	N/D	N/D	N/D	N/D	N/D
5.0L MPI DTS	5.0L	305	V-8	2010	A064825 & SUP	N/D	N/D	N/D	N/D	N/D	N/D
350 MAG ALPHA EFI (GEN +)	5.7L	350	V-8	1996-1997	F800300 - K999999	18-7685	18-7632	18-7630	N/D	N/D	18-7684
350 MAG BRAVO MPI	5.7L	350	V-8	1995-1996	F415189 - K001500	N/D	18-7632	18-7630	N.L.A.	N/D	18-7684 ②
350 MAG BRAVO MPI (GEN +)	5.7L	350	V-8	1997	K001501 - K999999	N/D	18-7632	18-7630	N/D	N/D	18-7684 ②
350 MAG EFI SKI	5.7L	350	V-8	1994-1996	F215561 - F820706	18-7685	18-7632	18-7630	N/D	N/D	18-7684
350 MAG EFI SKI	5.7L	350	V-8	1996	F820707 - K040005	18-7685	18-7632	18-7630	N/D	N/D	18-7684
350 MAG MPI	5.7L	350	V-8	1998	L010019 - L331598	N/D	18-7697	18-7700	N/D	N/D	N/D
350 MAG MPI	5.7L	350	V-8	1998	L336000 - L346999	N/D	18-7697	18-7700	N/D	N/D	N/D
350 MAG MPI	5.7L	350	V-8	1999	L331599 - L335999	N/D	18-7697	18-7757	N/D	N/D	N/D
350 MAG MPI	5.7L	350	V-8	1999-2001	L340000 - M299999	N/D	18-7697	18-7757	N/D	N/D	N/D
350 MAG MPI	5.7L	350	V-8	2002-2007	M300000 - A064824	18-7688	18-7701	18-7700	N/D	N/D	N/D ②
350 MAG MPI DTS	5.7L	350	V-8	2005-2007	W310000 - A064824	18-7688	N/D	N/A	N/D	N/D	N/D ②
350 MAG MPI DTS	5.7L	350	V-8	2007-2010	A064825 & SUP	N/D	N/D	N/A	N/D	N/D	N/D ②
350 MAG MPI HORIZON	5.7L	350	V-8	2002-2007	M300000 - A064824	18-7688	18-7701	18-7700	N/D	N/D	N/D ②
350 MAG MPI HORIZON	5.7L	350	V-8	2007	A064825 - A299999	N/D	18-7701	18-7700	N/D	N/D	N/D ②
350 MAG MPI HORIZON DTS	5.7L	350	V-8	2005-2007	W310000 - A064824	18-7688	N/D	N/A	N/D	N/D	N/D ②
350 MAG MPI HORIZON DTS	5.7L	350	V-8	2007	A064825 - A299999	N/D	N/D	N/A	N/D	N/D	N/D ②
350 MAG MPI HORIZON MIE	5.7L	350	V-8	1999-2001	L304700 - M299999	N/D	18-7697	18-7757	N/D	N/D	N/D
350 MAG MPI HORIZON MIE	5.7L	350	V-8	2002-2004	M300000 - M398371	18-7688	18-7701	18-7700	N/D	N/D	N/D ②
350 MAG MPI HORIZON MIE	5.7L	350	V-8	2004-2007	M398372 - A064824	18-7688	18-7701	18-7700	N/D	N/D	N/D ②
350 MAG MPI HORIZON MIE	5.7L	350	V-8	2007	A064825 - A089999	N/D	18-7701	18-7700	N/D	N/D	N/D ②
350 MAG MPI HORIZON MIE DTS	5.7L	350	V-8	2005-2007	W390000 - A064824	18-7688	N/D	N/A	N/D	N/D	N/D ②
350 MAG MPI HORIZON MIE DTS	5.7L	350	V-8	2007	A064825 - A089999	N/D	N/D	N/A	N/D	N/D	N/D ②
350 MAG MPI MIE	5.7L	350	V-8	1998	L002008 - L302199	N/D	18-7697	18-7700	N/D	N/D	N/D
350 MAG MPI MIE	5.7L	350	V-8	1999-2001	L302200 - M299999	N/D	18-7697	18-7757	N/D	N/D	N/D
350 MAG MPI MIE	5.7L	350	V-8	2002-2004	M300000 - M398371	18-7688	18-7701	18-7700	N/D	N/D	N/D ②
350 MAG MPI MIE	5.7L	350	V-8	2004-2007	M398372 - A064824	18-7688	18-7701	18-7700	N/D	N/D	N/D ②
350 MAG MPI MIE	5.7L	350	V-8	2007	A064825 - A089999	N/D	18-7701	18-7700	N/D	N/D	N/D ②
350 MAG MPI MIE	5.7L	350	V-8	2007	A064825 - A089999	N/D	18-7701	18-7700	N/D	N/D	N/D ②
350 MAG MPI MIE DTS	5.7L	350	V-8	2005-2007	W390000 - A064824	18-7688	N/D	N/D	N/D	N/D	N/D ②
350 MAG MPI MIE DTS	5.7L	350	V-8	2007	A064825 - A089999	N/D	N/D	N/D	N/D	N/D	N/D ②
350 MAG EFI SKI	5.7L	350	V-8	1994-1996	F215561 - F820706	18-7685	18-7632	18-7630	N/D	N/D	18-7684
350 MAG MPI SKI	5.7L	350	V-8	1998	L002600 - L304599	N/D	18-7697	18-7700	N/D	N/D	N/D
350 MAG MPI SKI	5.7L	350	V-8	1999-2001	L304600 - M299999	N/D	18-7697	18-7757	N/D	N/D	N/D
350 MAG MPI SKI	5.7L	350	V-8	2002-2007	M300000 - A064824	N/D	18-7701	18-7700	N/D	N/D	N/D ②

① BRAVO APPS WSN W060000, PIDE REGULATOR # 892681 ② MAPA SENSOR (TEMP & PRESIÓN)

Modelo	Litro	CID	# Cil	Intervalo de años	Rango de serie	Inyector	IAC Válvula	TPS	F/P Regulador montados en riel	F/P Refrigerador Regular montado	Sensor de picado
350 MAG MPI SKI	5.7L	350	V-8	2007	A064825 - A089999	N/D	18-7701	18-7700	N/D	N/D	N/D
5.7L EFI	5.7L	350	V-8	1995-1997	F225560 - K999999	18-7685	18-7632	18-7630	N/D	N/D	18-7684
5.7L EFI (GEN +)	5.7L	350	V-8	1998-2001	L010035 - M299999	18-7685	18-7632	18-7630	N/D	N/D	N/D
5.7L EFI MIE (GEN +)	5.7L	350	V-8	1997	K040300 - K999999	18-7685	18-7632	18-7630	N/D	N/D	18-7684
5.7L MPI HORIZON MIE	5.7L	350	V-8	2008-2010	A090000 - & SUP	N/D	18-7701	18-7700	N/D	N/D	N/D
5.7L MPI HORIZON DTS MIE	5.7L	350	V-8	2008-2010	A090000 - & SUP	N/D	N/D	N/D	N/D	N/D	N/D
5.7L MPI MIE	5.7L	350	V-8	2008-2010	A090000 - & SUP	N/D	18-7701	18-7700	N/D	N/D	N/D
5.7L MPI DTS MIE	5.7L	350	V-8	2008-2010	A090000 - & SUP	N/D	N/D	N/D	N/D	N/D	N/D
5.7L MPI SKI	5.7L	350	V-8	2008-2010	A090000 - & SUP	N/D	N/D	18-7700	N/D	N/D	N/D
5.7LX BRAVO EFI (GEN +)	5.7L	350	V-8	1996-1997	F800300 - K999999	18-7685	18-7632	18-7630	N/D	N/D	18-7684
5.7LX EFI	5.7L	350	V-8	1995-1997	F225560 - K999999	18-7685	18-7632	18-7630	N/D	N/D	18-7684
BLACK SCORPION SKI		350	V-8	1996	F350583 - K040000	N/D	18-7697	18-7700	N.L.A.	N.L.A.	18-7684
BLACK SCORPION SKI		350	V-8	1997	K040001 - L002699	N/D	18-7697	18-7700	N/D	N/D	18-7684
BLACK SCORPION SKI		350	V-8	1998	L002700 - L005600	N/D	18-7697	18-7700	N/D	N/D	N/D
BLACK SCORPION SKI		350	V-8	1998-2002	L005601 - M391599	N/D	18-7697	18-7757	N/D	N/D	N/D
BLACK SCORPION SKI		350	V-8	2003-2010	M391600 - W698432	N/D	18-7701	18-7757	N/D	N/D	N/D
SCORPION 350	5.0L	350	V-8	2008-2010	W698433 & SUP	N/D	18-7701	18-7757	N/D	N/D	N/D
377 MAG		377	V-8	2008-2010	A300000 & SUP	N/D	18-7701	18-7700	N/D	N/D	N/D
377 MAG DTS		377	V-8	2008-2010	A300000 & SUP	N/D	N/D	N/D	N/D	N/D	N/D
377 SCORPION MCM		377	V-8	1999-2005	L416146 - M907201	N/D	18-7697	18-7757	N/D	N/D	18-7684
377 SCORPION SKI		377	V-8	1997-1998	K000656 - L600314	N/D	18-7697	18-7700	N/D	N/D	18-7684
MX 6.2L MPI	6.2L	377	V-8	2000-2001	L680003 - M299999	N/D	18-7697	18-7757	N/D	N/D	N/D
MX 6.2L MPI	6.2L	377	V-8	2002-2004	M300000 - W059999	18-7688	18-7701	18-7700	N/D	N/D	N/D
MX 6.2L MPI	6.2L	377	V-8	2004-2007	W060000 - A064824	18-7688	18-7701	18-7700	N/D	N/D	N/D
MX 6.2L MPI	6.2L	377	V-8	2007	A064825 - A299999	N/D	18-7701	18-7700	N/D	N/D	N/D
MX 6.2L MPI DTS.	6.2L	377	V-8	2005-2007	W310000 - A064824	18-7688	N/D	N/D	N/D	N/D	N/D
MX 6.2L MPI DTS.	6.2L	377	V-8	2007	A064825 - A299999	N/D	N/D	N/D	N/D	N/D	N/D
MX 6.2L MPI HORIZON	6.2L	377	V-8	2002-2004	M300000 - W059999	18-7688	18-7701	18-7700	N/D	N/D	N/D
MX 6.2L MPI HORIZON	6.2L	377	V-8	2004-2007	W060000 - A064824	18-7688	18-7701	18-7700	N/D	N/D	N/D
MX 6.2L MPI HORIZON	6.2L	377	V-8	2007	A064825 - A299999	N/D	18-7701	18-7700	N/D	N/D	N/D
MX 6.2L MPI HORIZON DTS	6.2L	377	V-8	2005-2007	W310000 - A064824	18-7688	N/D	N/D	N/D	N/D	N/D
MX 6.2L MPI HORIZON DTS	6.2L	377	V-8	2007	A064825 - A299999	N/D	N/D	N/D	N/D	N/D	N/D
MX 6.2L MPI HORIZON MIE	6.2L	377	V-8	2002-2004	M300000 - M398394	18-7688	18-7701	18-7700	N/D	N/D	N/D
MX 6.2L MPI HORIZON MIE	6.2L	377	V-8	2004-2007	M398395 - A064825	18-7688	18-7701	18-7700	N/D	N/D	N/D
MX 6.2L MPI HORIZON MIE	6.2L	377	V-8	2007-2010	A064825 & SUP	N/D	18-7701	18-7700	N/D	N/D	N/D
MX 6.2L MPI HORIZON MIE DTS	6.2L	377	V-8	2005-2007	W390000 - A064824	18-7688	N/D	N/D	N/D	N/D	N/D
MX 6.2L MPI HORIZON MIE DTS	6.2L	377	V-8	2007-2010	A064825 & SUP	N/D	N/D	N/D	N/D	N/D	N/D
MX 6.2L MPI MIE	6.2L	377	V-8	2002-2004	M300000 - M398394	18-7688	18-7701	18-7700	N/D	N/D	N/D
MX 6.2L MPI MIE	6.2L	377	V-8	2004-2007	M398395 - A064825	18-7688	18-7701	18-7700	N/D	N/D	N/D
MX 6.2L MPI MIE	6.2L	377	V-8	2007-2010	A064825 & SUP	N/D	18-7701	18-7700	N/D	N/D	N/D
MX 6.2L MPI MIE DTS	6.2L	377	V-8	2005-2007	W390000 - A064824	18-7688	N/D	N/D	N/D	N/D	N/D
MX 6.2L MPI MIE DTS	6.2L	377	V-8	2007-2010	A064825 & SUP	N/D	N/D	N/D	N/D	N/D	N/D
MX 6.2L MPI SKI	6.2L	377	V-8	2002-2007	M317000 - W689999	18-7688	18-7701	18-7700	N/D	N/D	N/D
MX 6.2L BLACK SCORPION SKI	6.2L	377	V-8	2001-2003	L005601 - M391599	N/D	18-7697	18-7757	N/D	N/D	N/D
MX 6.2L BLACK SCORPION SKI	6.2L	377	V-8	2003-2007	M391750 - W698432	N/D	18-7701	18-7757	N/D	N/D	N/D
454 MAG EFI	7.4L	454	V-8	1994-1996	F115700 - F802349	N/D	18-7632	18-7630	N/D	N/D	18-7684
454 MAG EFI SKI	7.4L	454	V-8	1995-1996	F215800 - F820099	N/D	18-7632	18-7630	N/D	N/D	18-7684
454 MAG EFI SKI	7.4L	454	V-8	1996-1997	F820099 - K999999	N/D	18-7632	18-7630	N/D	N/D	18-7684
454 MAG MPI	7.4L	454	V-8	1996-1997	F802350 - K147349	N/D	18-7632	18-7630	N/D	N/D	18-7684
454 MAG MPI	7.4L	454	V-8	1997-1998	K147350 - L085399	N/D	18-7632	18-7630	N/D	N/D	18-7684
454 MAG MPI	7.4L	454	V-8	1999-2001	L085400 - M024999	N/D	18-7632	18-7630	N/D	N/D	18-7684
454 MAG MPI HORIZON MIE	7.4L	454	V-8	1998	L002200 - L086049	N/D	18-7632	18-7630	N/D	N/D	18-7684
454 MAG MPI HORIZON MIE	7.4L	454	V-8	1999-2001	L086050 - L674000	N/D	18-7632	18-7630	N/D	N/D	18-7684
7.4L MPI (L29)	7.4L	454	V-8	1998-2001	L010003 - M024330	N/D	18-7697	18-7700	18-7663	N/D	N/D
7.4L MPI MIE	7.4L	454	V-8	1995-1996	F563052 - K147349	N/D	18-7632	18-7630	N/D	N/D	18-7684
7.4L MPI MIE	7.4L	454	V-8	1997	K147350 - K999999	N/D	N/D	18-7630	N/D	N/D	18-7684
7.4L MPI MIE (L29)	7.4L	454	V-8	1998-2001	L010003 - L674613	N/D	N/D	18-7700	18-7663	N/D	N/D
7.4LX TBI	7.4L	454	V-8	1996-1997	F820000 - K999999	N.L.A.	18-7632	18-7630	N/D	N/D	18-7684
7.4LX MPI	7.4L	454	V-8	1996	F602010 - K147349	N/D	18-7632	18-7630	N/D	N/D	18-7684
7.4LX MPI	7.4L	454	V-8	1997	K147350 - K999999	N/D	18-7632	18-7630	N/D	N/D	18-7684
496 MAG		496	V-8	2001-2004	M025000 - W059999	N/D	N/D	18-7700	18-7663	N/D	N/D
496 MAG		496	V-8	2004	W060000 - W060573	N/D	N/D	18-7700	18-7663	N/D	N/D
496 MAG		496	V-8	2004-2010	W060574 - & SUP	N/D	N/D	18-7700	N/D	N/D	N/D
496 MAG DTS		496	V-8	2001-2004	M025000 - W059999	N/D	N/D	N/D	18-7663	N/D	N/D
496 MAG DTS		496	V-8	2004	W060000 - W060573	N/D	N/D	N/D	18-7663	N/D	N/D
496 MAG HO		496	V-8	2001-2004	M025000 - W059999	N/D	N/D	18-7700	18-7663	N/D	N/D
496 MAG HO		496	V-8	2004	W060000 - W060461	N/D	N/D	18-7700	18-7663	N/D	N/D
496 MAG HO		496	V-8	2004-2010	W060462 - & SUP	N/D	N/D	18-7700	N/D	N/D	N/D
496 MAG HO DTS		496	V-8	2001-2004	M025000 - W059999	N/D	N/D	N/D	18-7663	N/D	N/D
496 MAG HO DTS		496	V-8	2004	W060000 - W060461	N/D	N/D	N/D	18-7663	N/D	N/D
496 MAG HO DTS		496	V-8	2004-2010	W060462 - & SUP	N/D	N/D	N/D	N/D	N/D	N/D
496 MAG & HO EC		496	V-8	2007-2010	A066166 & SUP	N/D	N/D	18-7700	N/D	N/D	N/D
496 MAG & HO DTS EC		496	V-8	2010		N/D	N/D	N/D	N/D	N/D	N/D
8.1L & HO MIE		496	V-8	2001-2004	M026000 - W089999	N/D	N/D	18-7700	18-7663	N/D	N/D
8.1L & HO MIE		496	V-8	2004	W090000 - W389999	N/D	N/D	18-7700	18-7663	N/D	N/D
8.1L & HO MIE		496	V-8	2004-2010	W390000 - & SUP	N/D	N/D	18-7700	N/D	N/D	N/D
8.1L & HO MIE DTS		496	V-8	2001-2004	M026000 - W089999	N/D	N/D	N/D	18-7663	N/D	N/D
8.1L & HO MIE DTS		496	V-8	2004	W090000 - W389999	N/D	N/D	N/D	18-7663	N/D	N/D
8.1L & HO MIE EC		496	V-8	2007-2010	W697154 - & SUP	N/D	N/D	18-7700	N/D	N/D	N/D
500 EFI	8.2L	502	V-8	1999-2005	L001477 - M907127	N/D	18-7632	N/D	N/D	N/D	18-7684
502 MAG MPI	8.2L	502	V-8	1993-1996	D840650 - K147349	N/D	18-7632	18-7630	N/D	N/D	18-7684
502 MAG MPI	8.2L	502	V-8	1997-1998	K147350 - L085432	N/D	18-7632	18-7630	N/D	N/D	18-7684
502 MAG MPI	8.2L	502	V-8	1999-2001	L085432 - M024999	N/D	18-7632	18-7630	N/D	N/D	18-7684
575 Sci	8.2L	502	V-8	2000-2005	L306696 - M950526	N.L.A.	18-7632	18-7630	N/D	N/D	N/D
575 Sci	8.2L	502	V-8	2000-2005	L306696 - M950526	N.L.A.	18-7632	18-7630	N/D	N/D	N/D
8.2L MAG	8.2L	502	V-8	2010	A350340 & SUP	N/D	N/D	18-7700	N/D	N/D	N/D
8.2L MIE	8.2L	502	V-8	2010	A350340 & SUP	N/D	N/D	18-7700	N/D	N/D	N/D
8.2L MPI MIE	8.2L	502	V-8	1996	F1819620 - K147349	N/D	18-7632	18-7630	N/D	N/D	18-7684
8.2L MPI MIE	8.2L	502	V-8	1997-1998	K127350 - L086012	N/D	18-7632	18-7630	N/D	N/D	18-7684
8.2L MPI MIE	8.2L	502	V-8	1999-2001	L086013 - L674200	N/D	18-7632	18-7630	N/D	N/D	18-7684

TODOS LOS CARBURADORES SIERRA INCLUYEN JUNTA BASE

- Precisión remanufacturada para alcanzar o exceder las especificaciones OEM
- Recalibrados y reprogramados para maximizar la eficiencia y rendimiento del combustible
- Prueba de flujo por todas partes del regulador a todos los carburadores
- La mezcla de combustible y ajustes ociosos son predeterminados para asegurar que sólo el menos ocioso y ajustes de estrangulador son necesarios durante la instalación
- Todas las bases son revésadas de nuevo y los manguitos del eje regulador sustituidos

 <p>18-7370N CARBURADOR Reemplaza: 3310-860070A2, 3310-806077A2, 3310-806078A2, 1389-9562A1, 1389-9350A2, 1389-8490A2, 1389-815396A2 Para: MCM 120/2.5L & 140/3.0L</p>	 <p>18-7373N MERCARB 2V CARBURADOR Reemplaza: Mercruiser 3310-864941A01 2002-2004 4.3L (s/n OM615000-OW300012 Use kit carb 18-7098-1</p>	 <p>18-7375N CARBURADOR Reemplaza: 3310-864942A01, 3310-861448A1 Para: 1998-2004 MCM 5.0L</p>	 <p>18-7376N CARBURADOR Reemplaza: 3310-864943A01, 3310-861245A1 Para: 1998 y nuevos 5.7L aplicaciones</p>
 <p>18-7615N CARBURADOR Q-JET Reemplaza: 1347-816373A4, 1347-804624R1, 1347-804624R02 Use kit carb 18-7095</p>	 <p>18-7639 CARBURADOR Reemplaza: 3310-864943A01, 86125A1 Mercarb-5.7L 2V 1998 y nuevos 5.7L (OL010337-OW300754) & 5.7L MIE (OL002003-OW090899) (Remanufacturado) Use kit carb 18-7098-1 & junta 18-0994</p>	 <p>18-7640 CARBURADOR Q-jet universal con inductor eléctrico (Remanufacturado) Use kit carb 18-7095 & junta 18-0994</p>	 <p>18-7603-1 CARBURADOR 2 cuerpos - Rochester Reemplaza: 1347-818622, 1376-5659A1, 1347-818622 1, 1347-818622R02 (Remanufacturado) Use kit carb 18-7075 & junta 18-0994 (izq) & 18-0434 (derecha)</p>
 <p>18-7604-1 CARBURADOR 4 cuerpos - Rochester Reemplaza: 3304-9354A2, 1347-804623R02, 1347-804623R1 (Remanufacturado) Use kit carb 18-7095 & junta 18-2648</p>	 <p>18-7605-1 CARBURADOR 4 cuerpo - Rochester Reemplaza: 1347-9661A3, 1347-804623A1, 1347-804623R02 (Remanufacturado) Use kit carb 18-7095 & junta 18-2648</p>	 <p>18-7608-1 CARBURADOR 2 cuerpos - Rochester Reemplaza: 1347-818620, 1347-818620 1, 1347-818620R02 (Remanufacturado) Use kit carb 18-7070 & junta 18-0356</p>	 <p>18-7609-1 CARBURADOR 2 cuerpos - Rochester Reemplaza: 1347-818619, 1347-818619 1, 1347-818619 1R (Remanufacturado) Use kit carb 18-7070 & junta 18-0356</p>
 <p>18-7610-1 CARBURADOR 2 cuerpos - Rochester Reemplaza: 1347-818621, 1347-818621 1, 1347-818621 1R02 (Remanufacturado) Use kit carb 18-7070 & junta 18-0396</p>	 <p>18-7611-2 CARBURADOR 2 cuerpos - Rochester Reemplaza: 3310-807312A1, 3310-807312R02 (Remanufacturado) Use kit carb 18-7097 & junta 18-0994</p>	 <p>18-7613-1 CARBURADOR 4 cuerpos - Carter (Weber) Reemplaza: 3310-806969A1, 3310-806969R01 (Remanufacturado) Use junta 18-0467</p>	
 <p>18-7615-1 CARBURADOR 4 cuerpos - Rochester Reemplaza: 1347-816373A4, 1347-804624R1, 1347-804624R02 (Remanufacturado) Uses Carb Kit 18-7095 & junta 18-2548</p>	 <p>18-7616-1 CARBURADOR 4 cuerpos - Rochester Reemplaza: 1347-8288A1, 1347-804626R02 (Remanufacturado) Use kit carb 18-7072 & junta 18-2848</p>	 <p>18-7617-1 CARBURADOR 4 Barrel - Rochester Reemplaza: 1347-9863A3, 1347-804624R1, 1347-804625R02 (Remanufacturado) Use kit carb 18-7095 & junta 18-2848</p>	

TODOS LOS CARBURADORES SIERRA INCLUYEN JUNTA BASE

18-7618-1
CARBURADOR
 4 cuerpos - Rochester
 Reemplaza: 1347-8289A1,
 1347-804624R1, 1347-804624R02
(Remanufacturado)
 Use kit carb 18-7095 & junta 18-2848



18-7619-1
CARBURADOR
 4 cuerpos - Rochester
 Reemplaza: 1347-9142A2, 1347-8460A3
(Remanufacturado)
 Use kit carb 18-7095 & junta 18-0462



18-79994N
CARBURADOR
 Reemplaza: 3310-866142A04,
 3310-866142A03
 Para: TKS-5.0L



18-79995N
CARBURADOR
 Reemplaza: 3310-866143A03
 Para: TKS-5.7L



18-79996
CARBURADOR
(Remanufacturado)
 Reemplaza: 3310-818660A1
 Para: Weber 4.3L (1992-96)



18-79997
CARBURADOR
(Remanufacturado)
 Reemplaza: 3310-807826A1
 Para: Weber 4.3L (1996 & sup)



APLICACIÓN CARBURADOR

Modelo	CID / # Cil	intervalo de años	Desde Nº serie #	Hasta Nº Serie #	Original Carb Num. referencia	Código carb	Modelo rep. Carburador	Repuesto carb	Flotador Number	carburador Sierra Carb #
90	96/L4	1970-1971	2851424	3225967	1351- 4263A 1	7040082 R2/2GC	18-7746	1347-818619R02	18-7200	18-7609-1
90	96/L4	1972	3225868	3226957	1351- 4263A 1	7036543 R2/2GC	18-7746	1347-818619R02	18-7200	18-7609-1
110	153/L4	1963-1966	1357370	2044033	1336-2076	R2/2GC	—	—	—	18-7609-1
120	153/L4	1972-1973	3377341	3770649	1351-4263A3	7043182 R2/2GC	18-7746	1347-818619R02	18-7200	18-7609-1
120	153/L4	1974-1975	3770650	4469865	1351-5202A1	7044182 R2/2GC	18-7746	1347-818619R02	18-7200	18-7609-1
120	153/L4	1976-1978	4469866	5192048	1351-6065A2	7044182 R2/2GC	18-7746	1347-818619R02	18-7200	18-7609-1
120	153/L4	1979-1982	5192049	6229717	1351-7354A1	17059054 R2/2GC	18-7746	1347-818619R02	18-7200	18-7609-1
120	153/L4	1983	6229718	6663797	1351- 8480A 2	17081060 R2/2GC	18-7746	1347-818621R02	18-7200	18-7610-1
120	153/L4	1984	6663798	6853913	1389- 8490A 2	M2/MERCarb	18-7097	3310-860070A 2	18-7202	—
120	153/L4	1985	6853914	A492055	1389- 9350A 2	M2/MERCarb	18-7097	3310-860070A 2	18-7202	—
120	153/L4	1986	A492056	B531853	1389- 9562A 1	M2/MERCarb	18-7098-1	3310-860070A 2	18-7202	—
2.5L	153/L4	1983-1989	B531854	C853255	3310-806077A 2	M2/MERCarb	18-7098-1	3310-860070A 2	18-7202	—
140	181/L4	1968-1969	2508261	2816416	1351- 3635A 1	7036646 R/2GC	18-7746	—	18-7200	—
140	181/L4	1970	2816417	2911439	1351- 4032A 1	7040080 R/2GC	18-7746	1347-818620R02	18-7200	18-7608-1
140	181/L4	1970-1973	2911440	3771644	1351-4293A1	7040084 R/2GC	18-7746	1347-818620R02	18-7200	18-7608-1
140	181/L4	1974-1978	3771645	5157668	1351-5203A1	7043184 R/2GC	18-7746	1347-818620R02	18-7200	18-7608-1
140	181/L4	1979-1982	5157669	6229717	1351-7355A1	17059052 R/2GC	18-7746	1347-818620R02	18-7200	18-7608-1
140	181/L4	1983	6229718	6671328	1351- 8480A 2	17081060 R/2GC	18-7746	1347-818521R02	18-7200	—
140	181/L4	1984	6671329	6852269	1389- 8490A 2	M2/MERCarb	18-7097	3310-860070A 2	18-7202	—
140	181/L4	1985	6852270	A484072	1389- 9350A 2	M2/MERCarb	18-7097	3310-860070A 2	18-7202	—
140	181/L4	1986	A484073	B450800	1389- 9562A 1	M2/MERCarb	18-7098-1	3310-860070A 2	18-7202	—
140/3.0L	181/L4	1983-1989	6229718	C856556	1351-8480A2	R2/2GC	—	1348-818621 1	—	18-7610-1
3.0L	181/L4	1987-1989	B450801	C856556	3310-806077A 2	M2/MERCarb	18-7098-1	3310-860070A 2	18-7202	—
3.0L	181/L4	1990	C856559	D447414	1389-815396A 2	M2/MERCarb	18-7098-1	3310-860070A 2	18-7202	—
3.0L	181/L4	1991-1993	D447415	D836075	1389-806077A 2	M2/MERCarb	18-7098-1	3310-860070A 2	18-7202	—
3.0L	181/L4	1993-1994	D836076	F603999	1389-806078A 1	M2/MERCarb	18-7098-1	3310-860070A 2	18-7202	—
3.0L	181/L4	1998-2002	L010042	M385672	3310-807504A 1	M2/MERCarb	18-7098-1	3310-8M0045397	18-7202	—
3.0L	181/L4	2003-2004	M385673	W301999	3310-864940A01	M2/MERCarb	18-7098-1	3310-8M0045397	18-7202	—
3.0L	181/L4	1999-2004	L382122	W301999	3310-864940A01	M2/MERCarb	18-7098-1	865959A01	18-7202 ⑤	—
3.0L	181/L4	2004-2010	W302000	& SUP	3310-866140A02	M2/MERCarb	18-7098-1	3310-866140A02	18-7202	—
3.0LX	181/L4	1990-1997	C856559	K999999	1389-815397A 2	M2/MERCarb	18-7098-1	3310-8M0045397	18-7202	—
3.0LX	181/L4	1990-1997	C856559	K999999	3310-805924A 2	M2/MERCarb	18-7098-1	3310-8M0045397	18-7202	—
165 (4 CIL)	224/L4	1987	B434941	B774251	1389- 9564A 1	M2/MERCarb	18-7098-1	3310-860071A 2	18-7202	—
170	224/L4	1985-1989	6916779	B434940	1389- 9564A 1	M2/MERCarb	18-7098-1	3310-860071A 2	18-7202	—
180	224/L4	1987	B436391	B775248	1347- 9142A 2	17083522 R4/4ME	18-7077	—	18-7201	—
190 (4 CIL)	224/L4	1985-1986	6916779	B436390	1347- 9142A 2	17083522 R4/4ME	18-7077	—	18-7201	—
3.7L	224/L4	1988-1989	B774252	& SUP	1389- 9564A 1	M2/MERCarb	18-7098-1	3310-860071A 2	18-7202	—

- ① Starter automático
- ② Negro
- ③ Azul
- ④ Starter eléctrico frontal (azul)

- ⑥ En línea
- ⑦ Parte trasera (azul)
- ⑧ Separador montado
- ⑨ Utilizar si es MERCarb carb.original
- ⑩ Utilizar si es carb. original Rochester

- ① Use con transmisión en línea
- ② Use con transmisión V-drive
- ③ V-drive
- ④ Cuña montada
- ⑤ TKS kit actualización

APLICACIÓN CARBURADOR

Modelo	CID / # Cil	Intervalo de años	Desde Nº serie #	Hasta Nº Serie #	Original Carb Num. referencia	Código carb	Modelo rep. Carburador	Repuesto carb	Flotador Número	Carburador Sierra Carb #
3.7LX	224L4	1988-1989	B775249	& SUP	1347-9142A 2	17083522 R4/4ME	18-7077	—	18-7201	—
470	224L4	1976-1984	4208730	6916778	1376-5990A 1	17057132 R2/2GC	18-7076	3310-860071A 4	18-7202	⑩
470	224L4	1983-1984	6218037	6916778	1389-8489A 5	M2/MERCARB	18-7097	3310-860071A 2	18-7202	⑨
485	224L4	1980-1982	5685394	6218036	1376-5990A 1	17057132 R2/2GC	18-7076	3310-860071A 4	18-7202	—
488	224L4	1983-1984	6170297	6916778	1347-8460A 3	17081299 R4/4ME	18-7077	—	18-7201	18-7619-1
150	230L6	1964-1966	1830152	2048046	1338-2633	8025188 R2/2GC	18-7746	—	18-7200	—
160	250L6	1967-1968	2048022	2492038	1338-2991	7026088 R2/2GC	18-7746	—	18-7200	—
160	250L6	1969	2492036	277031	1351-3635A 1	7036646 R/2GC	18-7746	—	18-7200	—
165 (6 Cil)	250L6	1970-1972	3774865	3354791	1351-4282A1	7043183 R2/2GC	18-7746	1347-818620R02	18-7200	18-7608-1
165 (6 Cil)	250L6	1979-1981	5178959	5813433	1351-7356A1	17059050 R2/2GC	18-7746	1347-818620R02	18-7200	18-7608-1
165 (6 Cil)	L6	1972-1973	3354702	3774864	1351-4871A1	R2/2GC	—	1347-818620 1	—	18-7608-1
180/190 3.7L, L4 Engine	—	1985-1989	6916779	último	1347-9142A2	R4/4ME	—	1347-8460	—	18-7619-1
200 (6 Cil)	292L6	1969	2453769	2494935	1347-3237A 4	7037082 R4/4MV	18-7077	—	18-7201	—
185 (4bb)	229V-6	1993-1994	6330183	6919655	3300-8886A 2	17083515 R4/4ME	18-7077	—	18-7201	—
175	262V-6	1987	B527955	B773242	3304-9565A 1	M2/MERCARB	18-7098-1	3310-807764A 1	18-7202	—
185	262V-6	1985-1986	A331455	B527954	3304-9353A 2	M2/MERCARB	18-7097	3310-807764A 1	18-7202	—
205	262V-6	1985-1987	A331455	B775129	3304-9354A2	17084516 R4/4MV	18-7077	—	18-7201	18-7605-1
4.3L	262V-6	1988-1992	B773243	D714106	3304-9565A 1	M2/MERCARB	18-7098-1	3310-807764A 1	18-7202	—
4.3L	262V-6	1992-1993	D714107	F000877	3304-9565A 1	M2/MERCARB	18-7098-1	3310-807764A 1	18-7202	—
4.3L	262V-6	1993-1995	F000878	F601126	3310-806972A 1	M2/MERCARB	18-7098-1	3310-807764A 1	18-7202	—
4.3L	262V-6	1996-2002	F601127	M614999	3310-807764A 1	M2/MERCARB	18-7098-1	3310-807764A 1	18-7202	—
4.3L	262V-6	2002-2004	M615000	W300012	3310-864941A01	M2/MERCARB	18-7098-1	3310-864941A01	18-7202	—
4.3L	262V-6	2000-2004	L619000	W300012	3310-864941A01	M2/MERCARB	18-7098-1	865960A02	18-7202	⑤
4.3L	262V-6	2004-2010	W300013	& SUP	3310-866141A02	M2/MERCARB	18-7098-1	3310-866141A02	18-7202	—
4.3LH	262V-6	1998-2002	L010044	M614999	3310-807826A 1	9666 WEBER	18-7749	—	—	—
4.3LX	262V-6	1988-1991	B775130	D714369	3304-9354A 2	17084516 R4/4MV	18-7077	1347-804623R02	18-7201	18-7605-1
4.3LX	262V-6	1992-1996	D714370	F802999	3310-818660A 1	9600 WEBER	18-7749	—	—	—
4.3XH	262V-6	1996-1997	F803114	K999999	3310-807826A 1	9666 WEBER	18-7749	—	—	—
215 MCM/MIE (FORD)	302V-8	1970-1972	2781153	3385720	1356-4066	C9FF9510E H4/4160	18-7096	1356-804628R02	18-7206	—
225 MCM/MIE (FORD)	302V-8	1973-1974	3385721	4166999	1356-5155	D2JL9510C H4/4160	18-7096	1356-804628R02	18-7206	—
888	302V-8	1971-1977	3108723	4887829	1376-5659A1	7044185 R2/2GC	18-7075	1376-818622R02	18-7202	⑩
888	302V-8	1971-1977	3108723	4887829	1356-4642	D1J95108 H2/2300	18-7081	—	—	—
198 MIE	305V-8	1977	4776402	4931099	1376-6491A 1	17057139 R2/2GC	18-7075	3310-861080A 1	18-7202	—
200	305V-8	1985-1986	6899058	A482026	1389-8488A 2	M2/MERCARB	18-7097	3310-861080A 1	18-7202	—
200	305V-8	1985-1987	A482027	B525981	1389-9563A 1	M2/MERCARB	18-7098-1	3310-861080A 1	18-7202	—
200	305V-8	1987	B525982	B774444	1389-9670A 2	M2/MERCARB	18-7098-1	3310-807312A1	18-7202	—
228	305V-8	1977-1978	4765100	5069430	1347-6427A1	17057282 R4/4MV	18-7077	9661A 3	18-7201	18-7605-1
228	305V-8	1978-1981	5069431	6021783	1347-7361A1	17059292 R4/4MV	18-7077	9661A 3	18-7201	18-7605-1
228	305V-8	1982	6021784	6218461	1347-8296A4	17080565 R4/4MV	18-7077	9661A 3	18-7201	18-7605-1
228	305V-8	1982-1984	6218462	6899268	1347-9661A 3	17080565 R4/4MV	18-7077	9661A 3	18-7201	18-7605-1
228 MIE	305V-8	1977-1978	4765100	5069430	1347-6438A1	17057283 R4/4MV	18-7077	9661A 3	18-7201	18-7605-1
228 MIE	305V-8	1978-1982	5069431	6040745	1347-7364A1	17059291 R4/4MV	18-7077	9661A 3	18-7201	18-7605-1
228 TR	305V-8	1977-1978	4765100	5069430	1347-6438A 1	17057283 R4/4MV	18-7077	9661A 3	18-7201	18-7605-1
230	305V-8	1985-1987	6899269	B773739	1347-9661A 3	17080565 R4/4MV	18-7077	9661A 3	18-7201	18-7605-1
230 MIE	305V-8	1982-1987	6040746	B788151	1347-8290A1	17080564 R4/4MV	18-7077	9661A 3	18-7201	18-7605-1
223/230/5.0LX	V-8	1983-1995	6218462	F600999	1347-9661A3	R4/4MV	—	1347-9661A3	—	18-7605-1
5.0L	305V-8	1988-1995	B774445	F600999	1389-9670A 2	M2/MERCARB	18-7098-1	3310-807312A1	18-7202	—
5.0L (GEN +)	305V-8	1998-2002	L015751	M599999	3310-861448A 1	M2/MERCARB	18-7098-1	3310-864942A01	18-7202	—
5.0L (GEN +)	305V-8	2002-2004	M600000	W300009	3310-864942A01	M2/MERCARB	18-7098-1	3310-864942A01	18-7202	—
5.0L (GEN +)	305V-8	2000-2004	L619000	W300009	3310-864942A01	M2/MERCARB	18-7098-1	865961A02	18-7202	⑤
5.0L (GEN +)	305V-8	2004-2010	W300010	& SUP	3310-866142A03	M2/MERCARB	18-7098-1	3310-866142A04	18-7202	—
5.0LX	305V-8	1988-1995	B773740	F600999	1347-9661A 3	17080565 R4/4MV	18-7077	9661A 3	18-7201	18-7605-1
898/200/5.0L	V-8	1987-95	B525982	F600999	1389-9670A2	M2/MERCARB	—	3310-807312A1	—	18-7611-1
898	305V-8	1977	4762210	6021383	1376-6491A 1	17057139 R2/2GC	18-7075	3310-861080A 1	18-7202	—
898	305V-8	1982	6021384	6218461	1376-8295A 3	17080350 R2/2GC	18-7075	3310-861080A 1	18-7202	—
898	305V-8	1983-1984	6218462	6899057	1389-8488A 2	M2/MERCARB	18-7097	3310-861080A 1	18-7202	—
225 MCM/MIE (GM)	327V-8	1963-1969	1539620	2694014	1347-3237A 3	7037082 R4/4MV	—	1347-804624R02	—	18-7615N
250	350V-8	1977	4768000	4908849	1347-3353	7037082 R4/4MV	—	1347-804624R02	—	18-7615N
250	350V-8	1977	4768000	4908849	1347-3237A 3	7037082 R4/4MV	—	1347-804624R02	—	18-7615N
255	350V-8	1975-1976	4175550	4767999	1347-5732A 1	7044291 R4/4MV	18-7077	1347-804624R02	18-7201	18-7615N
255 MIE (GM)	350V-8	1975-1978	4175550	4924564	1347-5732A 1	7044291 R4/4MV	18-7077	1347-804624R02	18-7201	18-7615N
255 MIE (GM)	350V-8	1978	4924565	5195908	1347-7062A1	17057292 R4/4MV	18-7077	1347-804624R02	18-7201	18-7615N
255 MIE (GM)	350V-8	1979-1980	5195909	5907057	1347-7365A1	17059289 R4/4MV	18-7077	1347-804624R02	18-7201	18-7615N
260 MIE	V-8	1980-1986	5907058	B522505	1347-8289A1	R4/4MV	—	1347-8289A1	—	18-7618-1
260	350V-8	1978	4908850	5060805	1347-6492A 1	17057298 R4/4MV	18-7077	1347-804624R02	18-7201	18-7615N
260	350V-8	1976-1982	5060806	6024393	1347-7362A 1	17059288 R4/4MV	18-7077	1347-804624R02	18-7201	18-7615N
260	350V-8	1982-1987	6024393	B525981	1347-8292A 4	17080561 R4/4MV	18-7077	1347-804624R02	18-7201	18-7615N
260	350V-8	1987	B525982	B773304	1347-9662A 1	17080561 R4/4MV	18-7077	1347-804624R02	18-7201	18-7615N
260 MIE	350V-8	1981-1987	5907058	B522505	1347-8289A 1	17080562 R4/4MV	18-7077	1347-804624R02	18-7201	18-7615N
260 MIE	350V-8	1987	B522506	B788151	1347-9662A 1	17080561 R4/4MV	18-7077	1347-804624R02	18-7201	18-7615N

- ① Starter automático
- ② negro
- ③ Azul
- ④ Starter eléctrico
- ⑤ Frontal (Azul)
- ⑥ En línea
- ⑦ Parte trasera (azul)
- ⑧ Separador montado
- ⑨ Utilizar si es MERCARB carb. original
- ⑩ Utilizar si es carb. original Rochester
- ① Use con transmisión en línea
- ② Use con transmisión V-drive
- ③ V-drive
- ④ Cuña montada
- ⑤ TKS kit actualización

APLICACIÓN CARBURADOR

Modelo	CID / # Cil.	Intervalo año	Desde Nº serie #	Hasta Nº serie #	Original Carb Núm. ref	Código carb	Modelo rep. carb	Repuesto carb	Flotador	Carburador Sierra
260/5.7MIE	V-8	1987-1993	B522506	F024999	1347-966A4	R4/4MV	—	1347-816373A4	—	18-7615N
260/5.7L ALPHA	V-8	1987-1993	B525982	F000454	1347-9662A4	R4/4MV	—	1347-816373A4	—	18-7615N
270 MCM/MIE	350V-8	1969-1972	2851074	3385720	1347- 4180A 1	7029285 R4/4MV	18-7077	—	18-7201	—
280 TRS	350V-8	1975	4176250	4176468	1347- 4179A 2	7040283 R4/4MV	18-7077	—	18-7201	—
280 TRS	350V-8	1975-1976	4176469	4770199	1347- 5981A 1	7044290 R4/4MV	18-7077	—	18-7201	—
300 MR/TRS	350V-8	1985-1986	6668677	B430367	1347- 7498A 7	17059280 R4/4MV	18-7077	—	18-7201	18-7615N
350 MAG ALPHA	350V-8	1986-1991	A635178	D617327	1347- 8289A 1	17080562 R4/4MV	18-7077	1347-804624R02	18-7201	18-7615N
350 MAG ALPHA	350V-8	1992-1995	D617328	F600999	3310-806970A 1	9770SA WEBER	18-7749	3310-807262A 1	—	—
350 MAG ALPHA	350V-8	1996-1997	F601000	K999999	3310-807262A 2	9781 WEBER	18-7748	—	—	—
350 MAG SKI	350V-8	1991-1996	D505450	K040399	3310-806970A 1	9770SA WEBER	18-7749	—	—	①
350 MAG SKI	350V-8	1991-1997	D505450	K999999	3310-807262A 2	9781 WEBER	18-7748	—	—	①
350 MAG SKI	350V-8	1997	K040400	K999999	3310-860371A 1	9781SB WEBER	18-7748	—	—	②
5.7L (2BBL)	350V-8	1996-1997	F601000	K999999	3310-807312A1	M2/MERCARB	18-7098-1	3310-807312A1	18-7202	18-7611-2
5.7L (GEN +) (2bbl)	350V-8	1998-2002	L010037	M599999	3310-861245A 1	M2/MERCARB	18-7098-1	3310-864943A01	18-7202	18-7639
5.7L (GEN +) (2bbl)	350V-8	2002-2004	M600000	W300754	3310-864943A01	M2/MERCARB	18-7098-1	3310-864943A01	18-7202	18-7639
5.7L (GEN +) (2bbl)	350V-8	2000-2004	L015751	W300754	3310-864943A01	M2/MERCARB	18-7098-1	865962A02	18-7202	⑤
5.7L (Gen II)	V-8	1998-2004	L010037	W300754	3310-864943101	M2/MERCARB	—	3310-864943101	—	18-7639
5.7L (GEN +) (2bbl)	350V-8	2004-2010	W300755	& SUP	3310-866143A03	M2/MERCARB	18-7098-1	3310-866143A03	18-7202	—
5.7L ALPHA	350V-8	1988-1993	B773305	F000454	1347- 9662A 4	17080561 R4/4MV	18-7077	1347-804624R02	18-7201	18-7615N
5.7L ALPHA	350V-8	1993-1994	F000455	F273497	3310-805484A 1	9661 WEBER	18-7749	—	—	—
5.7L ALPHA	350V-8	1993-1994	F000455	F273497	3310-806761A 1	9665S WEBER	18-7748	—	—	—
5.7L ALPHA	350V-8	1994-1995	F273498	F600999	3310-806761A 3	9665S WEBER	18-7748	3310-806761A 3	—	—
5.7L BRAVO (W/O HIGH RISE INTAKE)	350V-8	1988-1991	B773305	D617327	1347- 9662A 4	17080561 R4/4MV	18-7077	1347-804624R02	18-7201	18-7615N
5.7L BRAVO (W/HIGH RISE INTAKE)	350V-8	1988-1991	B773305	D617327	1347- 8289A 1	17080562 R4/4MV	18-7077	1347-804624R02	18-7201	18-7615N
5.7L BRAVO W/O HIGH RISE INTAKE	V-8	1987-1991	OB525982	OD617327	1347-9662A4	R4/4MV	—	1347-816373A4	—	18-7615N
5.7L BRAVO W/HIGH RISE INTAKE	V-8	1987-1991	OB525982	OD617327	1347-8289A1	R4/4MV	—	1347-8289A1	—	18-7618-1
5.7L BRAVO	350V-8	1992-1995	D617328	F600999	3310-806970A 1	9770SA WEBER	18-7749	3310-807262A 1	—	—
5.7L MIE	350V-8	1988-1992	B768152	D715493	1347- 9662A 4	17080561 R4/4MV	18-7077	1347-804624R02	18-7201	18-7615N
5.7L MIE	350V-8	1992-1994	D715494	F349999	3310-806761A 2	9665S WEBER	18-7748	3310-806761A 2	—	—
5.7L MIE	350V-8	1995	F349300	F622099	3310-806761A 3	9665S WEBER	18-7748	3310-806761A 3	—	—
5.7L MIE (2bbl)	350V-8	1998-2002	L002003	M316999	3310-861245A 1	M2/MERCARB	18-7098-1	3310-864943A01	18-7202	18-7639
5.7L MIE (2bbl)	350V-8	2002-2004	M317000	W090899	3310-864943A01	M2/MERCARB	18-7098-1	3310-864943A01	18-7202	18-7639
5.7L MIE (2bbl)	350V-8	2000-2004	L390600	W090899	3310-864943A01	M2/MERCARB	18-7098-1	865962A02	18-7202	⑤
5.7L MIE (2bbl)	350V-8	2004-2010	W090900	& SUP	3310-866143A03	M2/MERCARB	18-7098-1	3310-866143A03	18-7202	—
5.7L SKI	350V-8	1985-1987	A338553	B514626	1347- 9415T	17085013 R4/4MV	18-7077	9415T	18-7201	—
5.7L SKI	V-8	1985-1993	A338553	F025099	1347-9415T	R4/4MV	—	1347-9415T	—	18-7615N
5.7L SKI	350V-8	1987-1995	F450000	F775199	3310-805484A 1	9661 WEBER	18-7749	3310-806761A 3	—	—
5.7L SKI (2bbl)	350V-8	1996-1997	F775200	K999999	3310-807312A1	M2/MERCARB	18-7098-1	3310-807312A1	18-7202	18-7611-2
5.7L SKI (GEN +) (2bbl)	350V-8	1998-2002	L002005	M316999	3310-861245A 1	M2/MERCARB	18-7098-1	3310-864943A01	—	18-7639
5.7L SKI (GEN +) (2bbl)	350V-8	2002-2004	M317000	W090899	3310-864943A01	M2/MERCARB	18-7098-1	3310-864943A01	—	18-7639
5.7L SKI (GEN +) (2bbl)	350V-8	2000-2004	L390600	W090899	3310-864943A01	M2/MERCARB	18-7098-1	865962A02	18-7202	⑤
5.7L SKI (GEN +) (2bbl)	350V-8	2004-2010	W090900	& SUP	3310-866143A03	M2/MERCARB	18-7098-1	3310-866143A03	18-7202	—
5.7LX (4bbl)	350V-8	1996-1997	F601000	K999999	3310-807262A 2	9761 WEBER	18-7748	—	—	—
233 MCM & MCI (FORD)	351V-8	1975-1977	4173000	4465029	1376- 5744 1	7044187 R2/2GC	18-7075	1347-818622R02	—	18-7603-1
233 MCM & MCI (FORD)	351V-8	1975-1977	4465030	4902304	1376- 6152A 1	17056197 R2/2GC	18-7075	1347-818622R02	—	18-7603-1
325 MCM/MIE	427V-8	1969-1970	2278747	3042730	1347- 3342	7027080 R4/4MV	18-7077	—	18-7201	—
325 MCM/MIE	427V-8	1971-1972	3042731	3780449	1347- 4533A 1	7041831 R4/4MV	18-7077	—	18-7201	—
325 MCM/MIE	427V-8	1969-1972	2278747	3780449	1347- 3689A 1	7029280 R4/4MV	18-7077	—	18-7201	—
330 MCM	427V-8	1977-1978	4623115	5027230	1347-6493A1	17057287 R4/4MV	18-7077	1347-804626R02	18-7201	18-7616-1
330 MCM	427V-8	1977-1981	5027231	6083144	1347-7363A1	17059290 R4/4MV	18-7077	1347-804626R02	18-7201	18-7616-1
330 MCM	427V-8	1982-1987	6083145	B816540	1347-8291A3	17080563 R4/4MV	18-7077	1347-804626R02	18-7201	18-7616-1
330 MIE	427V-8	1977-1978	4623115	5226384	1347-6493A1	17057287 R4/4MV	18-7077	1347-804626R02	18-7201	18-7616-1
330 MIE	427V-8	1979-1980	5226385	5889913	1347-7366A1	17059287 R4/4MV	18-7077	1347-804626R02	18-7201	18-7616-1
340 MIE	454V-8	1981-1987	5889914	D788365	1347-8288A1	17080560 R4/4MV	18-7077	1347-804626R02	18-7201	18-7616-1
370	454V-8	1978-1987	4179554	B714586	1347- 7498A 2	17059280 R4/4MV	18-7077	1347-804625R02	18-7201	—
400	454V-8	1980-1986	4179554	B457644	1347- 7498A 2	17059280 R4/4MV	18-7077	1347-804625R02	18-7201	—
420	454V-8	1987-1989	A398941	B622418	13549A 4	H4	18-7751	—	—	—
425	454V-8	1990-1993	B622419	D937011	13549A 4	H4	18-7751	—	—	—
440	454V-8	1983-1986	4179554	B485220	1393- 8862A 1	H4	18-7751	—	—	—
450	454V-8	1995-1996	F347100	F347277	13549A14	H4	18-7751	—	—	—
454 MAG ALPHA	454V-8	1986-1988	A631894	B785148	1347-8291A3	17080563 R4/4MV	18-7077	1347-804626R02	18-7201	18-7616-1
454 MAG BRAVO	454V-8	1988-1992	B721206	D808068	1347-7498A2	17059280 R4/4MV	18-7077	1347-804625R02	18-7201	18-7617-1
454 MAG BRAVO	454V-8	1992-1994	D805069	F304999	3310-806755A 1	9779 WEBER	18-7748	—	—	—
454 MAG BRAVO	454V-8	1995-1997	F305000	K999999	3310-806755A 2	9779 WEBER	18-7748	—	—	—
7.4L BRAVO I/II	454V-8	1988-1991	B771113	D603117	1347-8291A3	17080563 R4/4MV	18-7077	1347-804626R02	18-7201	18-7616-1
7.4L BRAVO I/II	454V-8	1992-1994	D603118	F351999	3310-806969A 2	9780 WEBER	18-7748	—	—	—
7.4L BRAVO I/II	454V-8	1995-1997	F352000	K999999	3310-806969A 1	9780 WEBER	18-7748	3310-806969A 1	—	18-7613-1
7.4L BRAVO III	454V-8	1993-1996	D838819	F800699	3310-806755A 2	9779 WEBER	18-7748	—	—	—

- ① Starter automático
- ② Negro
- ③ Azul
- ④ Starter automático
- ⑤ Frontal (Azul)

- ⑥ En línea
- ⑦ Parte trasera (azul)
- ⑧ Separador montado
- ⑨ Utilizar si es MERCARB carb. original
- ⑩ Utilizar si es carb. original Rochester

- ⑪ Use con transmisión en línea
- ⑫ Use con transmisión V-drive
- ⑬ V-drive
- ⑭ Cufia montada
- ⑮ TKS Kit actualización

APLICACIÓN CARBURADOR

Modelo	CID / # Cil	Intervalo Años	Desde Nº serie #	Hasta Nº serie #	Original Carb Núm. ref	Modelo Código carb	Modelo rep. carb	Repuesto carb.	Flotador	carburador Sierra
7.4L BRAVO III	454/V-8	1996-1997	F800700	K999999	3310-806969A1	9780 WEBER	18-7748	3310-806969A 1	—	18-7613-1
7.4L MIE	454/V-8	1988-1992	5889914	D715493	1347- 8268A 1	17080560 R4/4MV	18-7077	1347-804626R02	18-7201	18-7616-1
460	482/V-8	1983-1986	4179554	B485220	1393- 8862A 1	H4	18-7751	—	—	—
465	502/V-8	1990-1992	C849992	F213244	—	H4	18-7751	—	②	—
465	502/V-8	1990-1992	C849992	F213244	—	H4	18-7751	—	③	—
500	502/V-8	1994-1995	F213293	F615766	13549A12	H4	18-7751	—	③	—
500	502/V-8	1996-1998	F615767	L001772	13549A 15	H4	18-7751	—	③	—
500 (GEN +)	502/V-8	1999	L414639	L601036	13549T21	H4	18-7751	—	③	—
502 MAG	502/V-8	1990-1992	C878221	D824588	1347-814623A 2	17089112 R4/4MV	18-7077	—	18-7201	—
502 MAG	502/V-8	1992-1993	D824589	F114528	3310-806971A 1	9782 WEBER	18-7748	—	—	—
8.2L MIE	502/V-8	1990-1992	C878221	D857199	1347-814623A 2	17089113 R4/4MV	18-7077	—	—	—
8.2L MIE	502/V-8	1990-1992	C878221	D857199	3310-817693A 1	9774 WEBER	18-7748	—	—	—
8.2L MIE	502/V-8	1993-1996	D857200	F819619	3310-806971A 1	9782 WEBER	18-7748	—	—	—
500 BULLDOG	540/V-8	1990-1995	C577254	F348987	13549A10	H4	18-7751	—	③	—
500 BULLDOG	540/V-8	1995-2001	F615762	M050281	13549A23	H4	18-7751	—	③	—

- ① Starter automático
- ② negro
- ③ azul
- ④ Starter eléctrico
- ⑤ Frontal (Azul)

- ⑥ En línea
- ⑦ Parte trasera (azul)
- ⑧ Separador montado
- ⑨ Utilizar si es MERCarb carb.original
- ⑩ Utilizar si es carb. original Rochester

- ① Use con transmisión en línea
- ② Use con transmisión V-drive
- ③ V-drive
- ④ Cuña montada
- ⑤ TKS kit actualización

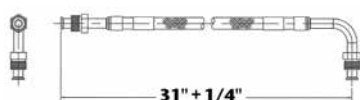

18-8114

LINEA DE COMBUSTIBLE

Conexión de la bomba de combustible. Reemplaza tubo de 3/8" X 31". PTFE con terminales macho de 5/8"-18 y 5/8"-18 90°. SAE J1527 tipo A1

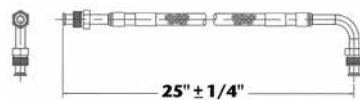

18-8115

LINEA DE COMBUSTIBLE

Conexión de la bomba combustible al carburador. Reemplaza tubo de 3/8" X 25" PTFE con terminales macho 5/8"-18 y 5/8"-18 90°. SAE J1527 tipo A1

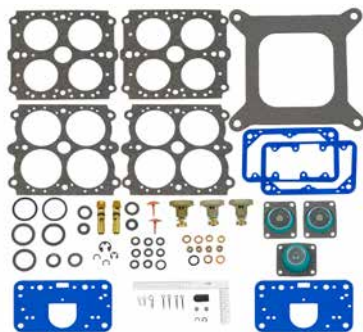

18-7751

KIT CARB

Reemplaza: 13220

Para: GM 420 V8 454 (1987-89), GM 425 V8 454 (1990-93), GM 425 (Gen V) V8 454 (1992-93), 440 TRS GM 454 (1983-86), GM 450 V8 454(1995-96), 460 TRS V8 482 (1983-86), GM 465 V8 502 (1990-92), GM 465 (Gen V) V8 502 (1992-94), 500 (Gen+) GM 502 V8 (1999), 500 (Gen V) 502 V8 (1994-98), 500 Bulldog 540 V8 (1990-01)



18-7071

KIT CARB

Reemplaza: 1397-3458



18-7075

KIT CARB

Reemplaza: 1397-5830, 1397-7099, 1397-8760, 1397-5831



18-7070

KIT CARB

Reemplaza: 1397-2072, 1397-7542, 1397-2637, 1397-7543, 1397-8872, 1397-3464,



**18-7072
KIT CARB**
Reemplaza: 1397-3306, 1397-4329,
1397-5635, 1397-6638, 823426A1



**18-7076
KIT CARB**
Reemplaza: 1397-6367, A1



**18-7077
KIT CARB**
Reemplaza: 1397-8952, 823426A1



**18-7078
KIT CARB**
Reemplaza: 1397-2605, 1397-3462,
1397-2133, 1337-2604, 1337-2103



**18-7080
KIT CARB**
Reemplaza: 1398-3089, 1346-2770



**18-7081
KIT CARB**
Reemplaza: 1396-4656
Contiene agujas y asientos ajustables



**18-7095
KIT CARB**
Reemplaza: 1397-7539, 1397-7540,
1397-7544, 1397-8535, 1397-9723



**18-7096
KIT CARB**
Reemplaza: 1396-5238, 1396-5222,
1356-5169, 1356-5155, 1356-4092,
1356-4066
Contiene agujas y asientos ajustables



**18-7097
KIT CARB**
Reemplaza: 3302-9437, 3302-804845
MerCarb 2 bbl. bottom fondo llenado bomba acelerador
1983-1986 MCM 120, 140, 470, 185, 200, 898.



**18-7098-1
KIT CARB**
Reemplaza 3302-804844002,
3302-804844001, 3302-804844
MerCarb 2 bbl. llenado lateral bomba acelerador
1986 y sup. MCM 4-cil., V6 & V8

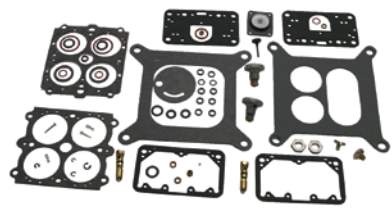

**18-7728
KIT CARB**

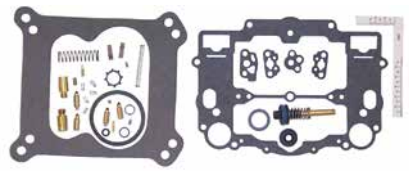

**18-7749
KIT CARB**
Reemplaza: 809065, 835076, 823728





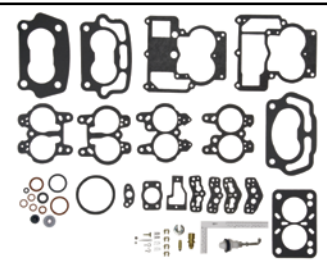

**18-7748
KIT CARB**
Reemplaza: 809064



**18-7746
KIT CARB**
Reemplaza: 823427A1, 1397-8873, 1397-
8872, 1397-7547, 1397-7543, 1397-7542,
1397-3464, 1397-3459, 1397-2637, 1397-
2634, 1397-2631, 1397-2067
Kit reparación para 2 BBL Rochester



**18-34075
KIT ESPACIADOR CARB**
Se adapta a Holley, Edelbrock, Carter AFB
cuadrado a colector Rochester

 <p>18-7200 FLOTADOR REEMPLAZA: 1397-2060 (Resistente al alcohol) Plástico</p>	 <p>18-7201 FLOTADOR Reemplaza: 1397-3327, 1397-8546, 1397-8959 (Resistente al alcohol) Brass</p>	 <p>18-7202 FLOTADOR Reemplaza: 1397-5837, 3302-9031 (Resistente al alcohol) Brass</p>
 <p>18-36906 FLOTADOR CARB Reemplaza: 811536, 811536T Para: Mercruiser con 4 bbl Weber Carb</p>	 <p>18-7666 INTERRUPTOR PRESIÓN Reemplaza: 1397-8582 carburadores Rochester 4V</p>	 <p>18-7664 TERMOSTATO STARTER Reemplaza: 809066 Carburadores Weber 4V con starter eléctrico</p>
 <p>18-7665 TERMOSTATO STARTER Reemplaza: 70125A1, 70125A02, 70125 Rochester & Mercarb 2V con starter eléctrico</p>	 <p>18-7667 TERMOSTATO STARTER Reemplaza: 71464A01, 71464, 72625 Carburador Rochester con estrangulador separado</p>	 <p>18-7227 TERMOSTATO STARTER Reemplaza: 1396-4148 Para carburador Holley</p>

APLICACIÓN KIT CARBURADOR/FLOTADOR

Modelo & serie #	Mercruiser Carb. #	Mfg. Carb. #	código carb & Modelo	Kit carb. ①	Flotador
TODOS MCM 80	1346-2770	RBS-4394S	C1/RBS	18-7080	—
MCM 90					
3225967 & Inf.	1351-4263A1	7040082	R2/2GC	18-7746	18-7200
3225968 & encima	1351-4263A2	7041369	R2/2GC	18-7746	18-7200
TODOS MCM110	1336-2076	7036543	R2/2GC	18-7070	18-7200
MCM 120/2.5L					
2520424 & inf.	1336-2076	7036543	R2/2GC	18-7746	18-7200
2520425-3377340	1336-3594A1	7036543	R2/2GC	18-7746	18-7200
3377341-3770649	1351-4263A3	7041369	R2/2GC	18-7746	18-7200
3770650-4469865	1351-5202A1	7043182	R2/2GC	18-7746	18-7200
4469866-5192047	1351-6065A2	7044182	R2/2GC	18-7746	18-7200
5192048-6229717	1351-7354A1	17059054	R2/2GC	18-7746	18-7200
6229718 & encima	1351-8480A2	17081060	R2/2GC	18-7746	18-7200
6229718 & encima	1389-8490A2	N/D	M2/Mercarb	18-7097	18-7202
6229718 & encima	1389-9350A2	N/D	M2/Mercarb	18-7097	18-7202
6229718 & encima	1389-9562A1	N/D	M2/Mercarb	18-7098-1	18-7202
MCM 140 /3.0L/3.0LX(4 cil.)					
2816416 & inf.	1351-3635A1	7036646	R2/2GC	18-7746	18-7200
2816417-3332137	1351-4032A1	7040080	R2/2GC	18-7746	18-7200
3332138-3771644	1351-4293A1	7040084	R2/2GC	18-7746	18-7200
3771645-5157668	1351-5203A1	7043184	R2/2GC	18-7746	18-7200
5157669-6229717	1351-7355A1	17059052	R2/2GC	18-7746	18-7200
6229718-C856558	1351-8480A2	17081060	R2/2GC	18-7746	18-7200
6229718-C856558	1389-8490A2	N/D	M2/Mercarb	18-7097	18-7202
6229718-C856558	1389-9350A2	N/D	M2/Mercarb	18-7097	18-7202
6229718-C856558	1389-9562A1	N/D	M2/Mercarb	18-7098-1	18-7202
C856559 & encima	1389-815396A2	N/D	M2/Mercarb	18-7098-1	18-7202
C856559 & encima	1389-815397A2	N/D	M2/Mercarb	18-7098-1	18-7202
MCM 140 (6 cil)					
TODOS (BC)	1338-2161	7025638	R1/BC	18-7071	—

① NO INCLUYE BARRAS DE MEDICIÓN

APLICACIÓN CARBURADOR KIT/FLOTADOR (Cont.)

Modelo & Serie #	carburador Mercruiser #	Mfg. Carb. #	Código carb & Modelo	Kit carb ①	Flotador
TODOS (B)	1338-2166	7025662	R1/B	18-7071	—
MCM 150					
1823489 & post	1338-2428	7024180	R1/BC	18-7071	—
1823489 & post	1338-2431	7024181	R1/B	18-7071	—
1823490-1830151	1338-2608	7025183	R1/BC	18-7071	—
1823490-1830151	1338-2609	7025184	R1/B	18-7071	—
1830152 & ant	1338-2633	7025188	R2/2GC	18-7070	18-7200
MCM 160					
2492035 & post	1338-2991	7026088	R2/2GC	18-7746	18-7200
2492036 & ant	1351-3635A1	7036646	R2/2GC	18-7746	18-7200
MCM 165 (6 cil)					
3354701 & post	1351-4282A1	7040083	R2/2GC	18-7746	18-7200
3354702-3774864	1351-4871A1	7042183	R2/2GC	18-7746	18-7200
3774865-5178958	1351-5204A1	7043183	R2/2GC	18-7746	18-7200
5178959 & ant	1351-7356A1	17059050	R2/2GC	18-7746	18-7200
MCM 165/170/3.7L (4 cil)					
6218037-6916778	1389-8489A5	N/D	M2/Mercarb	18-7097	18-7202
6916779 & ant	1389-9564A1	N/D	M2/Mercarb	18-7098-1	18-7202
MCM 175/4.3L/185 (V-6)	3304-9565A1	N/D	M2/Mercarb	18-7098-1	18-7202
Todos (229 CID)					
A221455-D714106	3300-8886A2	17083515	R4/4MV	18-7095	18-7201
185 (262 CID)					
A221455-B527954	3304-9353A2	N/D	M2/Mercarb	18-7097	18-7202
MCM 205 (262 CID)	3304-9354A2	—	R4/4MV	18-7095	18-7201
A331455-D714369	3304-9565A1	N/D	M2/Mercarb	18-7098-1	18-7202
TODOS MCM/MIE 470	1376-5990A1	17057132	R2/2GC	18-7076	18-7202
TODOS MCM 485	1376-5990A1	17057132	R2/2GC	18-7076	18-7202
TODOS MCM 488	1347-8460A3	17081299	R4/4ME	18-7077	18-7201
MCM 888					
TODOS HOLLEY	1356-4642	D1JJ-9510-8	H2/2300	18-7081	18-7206
TODOS ROCHESTER	1376-5659A1	7044185	R2/2GC	18-7075	18-7202
MCM 180/190/3.7LX					
(4 cil)	1347-9142A2	17083522	R4/4MV	18-7095	18-7201
MIE 198/200/5.0L					
6021383 & post	1376-6491A1	17057139	R2/2GV	18-7075	18-7202
6021384 & ant	1376-8295A3	17080350	R2/2GV	18-7075	18-7202
MCM 200 (6 cil)					
2494935 & post	1347-3237A2	7037082	R4/4MV	18-7072	18-7201
2494936 & ant	1347-3237A4	7037082	R4/4MV	18-7072	18-7201
MCM 898/200/5.0L					
6218462 & ant	1389-8488A2	N/D	M2/Mercarb	18-7097	18-7202
6218462 & ant	1389-9563A1	N/D	M2/Mercarb	18-7098-1	18-7202
6218462 & ant	1389-9670A2	N/D	M2/Mercarb	18-7098-1	18-7202
MCM 205/4.3LX (V-6 262 CID)					
A331455-D714369	3304-9354A2	17084516	R4/4MV	18-7095	18-7201
TODOS MCM/MIE 215	1356-4066	C9FF-9510-E	H4/4160	18-7096	18-7206
MCM/MIE 225 (FORD)					
TODOS	1356-5155	D2JL-9510-C	H4/4160	18-7096	18-7206
MCM/MIE 225 (GM)	1337-2103	7025564	R4/4GC	18-7078	—
1536920-2694014	1337-2604	7025756	R4/4GC	18-7078	—
	1347-3353	7037082	R4/4MV	18-7072	18-7201
	1347-3237A3	7037082	R4/4MV	18-7072	18-7201
MCM 228					
5069430 & post	1347-6427A1	17057282	R4/4MV	18-7072	18-7201
MCM 228TR/ MIE 228					
5069430 & post	1347-6438A1	17057283	R4/4MV	18-7072	18-7201
MCM 228/230/5.0L					
5069431-6021783	1347-7361A1	17059292	R4/4MV	18-7095	
6021784-6218461	1347-8296A4	17080565	R4/4MV	18-7095	18-7201
6218462 & post	1347-9661A3	—	R4/4MV	18-7095	18-7201
MIE 228					
5067431-6040745	1347-7364A1	17059291	R4/4MV	18-7095	18-7201

① NO INCLUYE BARRAS DE MEDICIÓN

APLICACIÓN CARBURADOR KIT/FLOTADOR (Cont.)

Modelo & Serie #	Carburador Mercruiser #	Mfg. Carb. #	Código carb & Modelo	Carb. Kit ①	Flotador
6040746 & ant	1347-8290A1	17080564	R4/4MV	18-7095	18-7201
TODOS MIE 230/5.0L	1347-8290A1	17080564	R4/4MV	18-7095	18-7201
230/5.0LX	1347-9661A3	—	R4/4MV	18-7095	18-7201
MCM/MIE 233					
4465029 & post	1376-5744A1	7044187	R2/2GC	18-7075	18-7202
4465030 & ant	1376-6152A1	17056197	R2/2GC	18-7075	18-7202
MCM/MIE 250 AUTO. CHOKE					
4767999 & post	1347-3353	7037082	R4/4MV	18-7072	18-7201
MCM/MIE 250 (EL. CHOKE)					
4767999 & post	1347-3237A3	7037082	R4/4MV	18-7072	18-7201
MCM 250					
4768000 & ant	1347-6492A1	17057298	R4/4MV	18-7072	18-7201
MCM/MIE 255 (GM)					
4924564 & post	1347-5732A1	7044291	R4/4MV	18-7072	18-7201
4924565-5195908	1347-7062A1	17057295	R4/4MV	18-7072	18-7201
5195909-5907067	1347-7365A1	17059289	R4/4MV	18-7095	18-7201
5907068 & ant	1347-8289A1	17080562	R4/4MV	18-7095	18-7201
MCM/MIE 255 (FORD)					
todos	1356-5169	D2JL-9510E	H4/4160	18-7096	18-7206
MCM 260/5.7L BRAVO					
5060805 & post	1347-6492A1	17057298	R4/4MV	18-7072	18-7201
5060806-6024393	1347-7362A1	17059288	R4/4MV	18-7095	18-7201
6024394-B525981	1347-8292A4	17080561	R4/4MV	18-7095	18-7201
B525982 & ant	1347-9662A4	—	R4/4MV	18-7095	18-7201
MIE 260/5.7L 350 MAG					
A635178-D617327	1347-8289A1	17080562	R4/4MV	18-7095	18-7201
MIE 5.7 SKI					
A339533-F205099	1347-9415T	17085013	R4/4MV	18-7095	18-7201
TODOS MCM/MIE 270	1347-4180A1	7029285	R4/4MV	18-7072	18-7201
MCM 280					
4176468 & post	1347-4179A2	7040283	R4/4MV	18-7072	18-7201
4176469 & ant	1347-5981A1	7044290	R4/4MV	18-7072	18-7201
MCM 300 MR/TRS (GM)					
6668677 & ant	1347-7498A7	—	R4/4MV	18-7095	18-7201
MCM/MIE 325 AUTO. CHOKE					
3042730 & post	1347-3342	7027080	R4/4MV	18-7072	18-7201
3042731 & ant	1347-4533A1	7041831	R4/4MV	18-7072	18-7201
MCM/MIE 325 EL. CHOKE					
2278747-378099	1347-3689A1	7029280	R4/4MV	18-7072	18-7201
MCM 330/454 MAGNUM (ALPHA ONE)					
5027230 & post	1347-6493A1	17057287	R4/4MV	18-7072	18-7201
5027231-6083144	1347-7363A1	17059290	R4/4MV	18-7095	18-7201
6083145 & ant	1347-8291A3	17080563	R4/4MV	18-7095	18-7201
MIE 330					
5226384 & post	1347-6493A1	17057287	R4/4MV	18-7072	18-7201
5226385 & ant	1347-7366A1	17059287	R4/4MV	18-7095	18-7201
MIE 340/7.4L					
TODOS	1347-8288A1	17080560	R4/4MV	18-7095	18-7201
MCM 350 MAGNUM/5.7L BRAVO					
B525992-317327	1347-8289A1	—	R4/4MV	18-7095	18-7201
TODOS MIE 350	1347-5326A2	17065977	R4/4MV	18-7072	18-7201
TODOS MCM 370/400	1347-7498A2	17059280	R4/4MV	18-7095	18-7201
MCM 7.4L (BRAVO ONE)	1347-8291A3	17080563	R4/4MV	18-7095	18-7201
MCM 454 7.4L					
6083145-B816540	—	—	H4/4150, R6647A	18-7728	—
MCM 454 MAGNUM					
TODOS (BRAVO ONE)	1347-7498A2	17059280	R4/4MV	18-7095	18-7201
	1347-9863A3	—	R4/4MV	18-7095	18-7201
MCM 502 MAGNUM (BRAVO ONE)					
C878221-D857199	1347-814623A2	—	R4/4MV	18-7095	18-7201
MCM 8.2L	1347-814623A2	—	R4/4MV	18-7095	18-7201

① NO INCLUYE BARRAS DE MEDICIÓN



18-7228
ANTI-DEFLAGRANTE
Reemplaza:
85784A1, 805016A1



18-7229
ANTI-DEFLAGRANTE
Reemplaza:
85785T, 85785-2



18-7230
ANTI-DEFLAGRANTE
Reemplaza:
41639A1, 41639



18-7231
ANTI-DEFLAGRANTE
Reemplaza: 85785A2



18-7232
ANTI-DEFLAGRANTE
Reemplaza:
57882, 57882T



18-7234
ANTI-DEFLAGRANTE
Reemplaza: 805016A1

ESPECIFICACIONES DE ANTI-DEFLAGRANTES DE ALUMINIO ANODIZADO

MOTOR	REF NO.	ALTURA A	ELEMENTO B	CUELLO C	TUBOS VENT*
4 & 6 cil.	18-7228	2.156	1.088	3.120	1
4 & 6 cil.	① 18-7234	2.280	1.550	3.100	0
V-8	18-7229	2.250	1.470	5.050	0
V-8	18-7230	2.250	1.470	5.050	1
V-8	18-7231	2.250	1.470	5.050	2
Altas prest.	18-7232	2.969	2.190	5.050	2

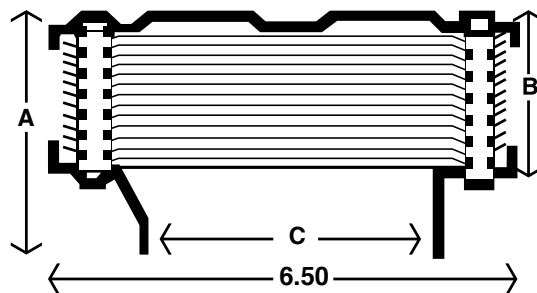

① 7" Diámetro externo * Los tubos de ventilación aceptan manguera 5/8 pulgadas DI

TODAS LAS BOMBAS DE GASOLINA INCLUYEN JUNTA DE MONTAJE

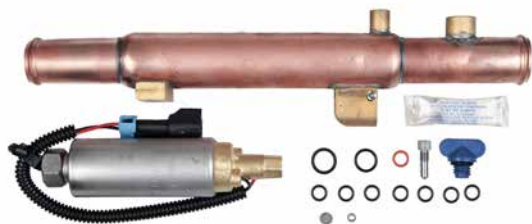

18-8861
BOMBA COMBUSTIBLE CON REFRIGERACIÓN
Reemplaza: 861156A02
Para: GM V-6/ V-8 EFI 0L000000-0M299999



18-8862
BOMBA COMBUSTIBLE CON REFRIGERACIÓN
Reemplaza: 861156A03
Para: GM V-6/ V-8 EFI 0M300000



18-8864
BOMBA COMBUSTIBLE CON REGULADOR
Reemplaza: 866169T01, 866169A01
Para: Gm V-8 con Gen III Modulo refrigeración comb-alta presión



18-8865
BOMBA COMBUSTIBLE
Reemplaza: 866170A01
Para: Gm V-8 con Gen III Modulo refrigeración comb-baja presión



18-8867
BOMBA COMBUSTIBLE
Reemplaza: 861155A6, 861155A5, 805656A6, 805656A5, 805656A2, 805025A2
Para: 4.3L V-6



18-8868
BOMBA COMBUSTIBLE
 Terminales con rosca
 Reemplaza: 861155A3, 861155A2
 Para: 5.0/ 5.7L V-8 & 4.3L



18-7326
BOMBA COMBUSTIBLE ELÉCTRICO
 Reemplaza: 805656A2, 805656A6,
 805656A5, 805025A2, 861155A6, 861155A5
 Para: 1992-93, 1996 F.I. & Carburador 4.3L
 con bomba eléctrica en-línea



18-35433
BOMBA COMBUSTIBLE ELÉCTRICO
 1 terminal con rosca, 1 terminal conector
 Reemplaza: 861156A1
 Para: Mercruiser V6 & V8 305/350/377/454/502 EFI (No-rosca)(Reemplaza bomba refrigeración comb.)



18-7266
BOMBA COMB
 Identificación D.I. # 41413, M6696
 Para: Ford (V-8) 302, 351



18-7267
BOMBA COMB
 Identificación D.I. # 41414
 Reemplaza: 62092T, 62092, 54552
 Para Ford (V-8) 302
 (Incluye junta)



18-7274
BOMBA COMB
 Identificación D.I. # 41421, M73021
 Reemplaza: 86246, 86246A1, 78485, 71646
 Para: GM (V-8) 305, 350, 400, 228 / 250 /
 255 / 260 / 280



18-7275
BOMBA COMB
 Identificación D.I. # 41422
 Reemplaza: 86247, 86247T, 86247A2,
 78820, 63196, 46860
 Para: GM (V-8) 454, 330 / 325 / 350 / 390
 (Incluye junta)



18-7278
BOMBA COMB
 Identificación D.I. # M60032
 Reemplaza: 86234A4, 86234A05,
 86234A3,
 86234, 77594, 71327, 47585
 Para: GM (4 & 6 Cil.) 153, 181, 225, 250,
 120 / 140 / 160 / 165 / 470 / 485 / 488
 Use filtro 18-7860 & junta 18-0889



18-7282
BOMBA COMB
 Identificación D.I. # M60337
 Reemplaza: 8M0073435, 861676T09
 Para: GM 4 cil. (2.5/3.0L) & Mercruiser 3.7L
 Use filtro 18-7784 & junta 18-0889



18-7283
BOMBA COMB
 Identificación D.I. # M60600
 Reemplaza: 8M0058164, 8M0058164, 97401
 Para: GM (V-8) 305, 350, 228 / 230 / 260 / 898
 Use junta 18-0889



18-7284
BOMBA COMB
 Identificación D.I. # M60315
 Reemplaza: 41141A2, 862077A1
 Para: GM (V-6) 231, 262, 229
 Use filtro 18-7784 & junta 18-0889



18-7288-1
BOMBA COMB
 Identificación D.I. #60601
 Reemplaza: 812454A1, 862048A1, 812454A3,
 97399A2, 97399
 Para: En línea (4 cil) 120, 140, 3.0L y 224 CID
 7.4L / 454 / 420 / 330



18-35437
BOMBA COMB
 Reemplaza: 42725A3, 861676A1,
 861676T09, 8M0073435
 Para: Mercruiser 3.0L (SN L097000 & Sup)
 (Incluye junta)



18-8860
BOMBA COMB
 Reemplaza: 861677T
 Para: APLICACIONES GM V-8 (454 & 502)
 (Incluye juntas)



18-7256
BOMBA COMB
 Identificación D.I. # 6790, M3530
 Reemplaza: 32722
 Para: GM (4 & 6 Cil.) 153, 230, 250, 292

APLICACIÓN BOMBA COMBUSTIBLE

Modelo	CID / # CIL	Intervalo año	Desde		Hasta		Bomba combustible #1	Bomba combustible #2	Filtro bomba
			Número serie	Número serie	Número serie	Número serie			
120	153/L4	1964-1972	1666601	3377340	18-7278	①	—	18-7860	
120	153/L4	1964-1972	1666601	3377340	18-7256	②	—	—	
120	153/L4	1972-1982	3377341	6229717	18-7278	—	—	18-7860	
120	153/L4	1983-1986	6229718	B531853	18-7278	③	—	18-7860	
120			4469866	& Inf	18-7278	—	—	—	
120			4469866	4952700	18-7278	—	—	—	
120			4952701	& Sup	18-7278	—	—	—	
120			5192049	6229717	18-7278	—	—	—	
120/2.5L			6229718	& Sup	18-7278	—	—	—	
120/2.5L			6229718	& Sup	18-7282	—	—	—	
2.5L	153/L4	1987-1989	B531854	BC853255	18-7278	④	—	18-7860	
140 (4 Cil.)	181/L4	1968-1982	2508261	6229717	18-7278	—	—	18-7860	
140 (4 Cil.)	181/L4	1983-1986	6229718	B450800	18-7278	⑤	—	18-7860	
3.0L	181/L4	1987-1989	B450801	C856558	18-7278	⑥	—	18-7860	
140			4460664 & Inf	& Inf	18-7278	—	—	—	
140			4460665	4918569	18-7278	—	—	—	
140			4918570	& Sup	18-7278	—	—	—	
140 (4 Cil.)			5157669	6229717	18-7278	—	—	—	
140/3.0L			6229717 & Inf	& Inf	18-7278	—	—	—	
140/3.0L			6229718 & Sup	& Sup	18-7282	—	—	—	
3.0L/3.0LX			C856559 & Sup	& Sup	18-7282	—	—	—	
140 (6 Cil.)			1538930	1725960	18-7256	—	—	—	
150			1666495	2048046	18-7256	—	—	—	
160			2048022	2770031	18-7278	—	—	—	
165			4471566	4884834	18-7278	—	—	—	
165			5178959 & Sup	& Sup	18-7278	—	—	—	
165/3.7L (4 Cil.)			6916779 & Sup	& Sup	18-7282	—	—	—	
180/3.7-LX (4 Cyl.)			6916779 & Sup	& Sup	18-7282	—	—	—	
175/4.3L (262 CID)			B527955 & Sup	& Sup	18-7284	—	—	—	
185 (229 CID)			6330183 & Sup	& Sup	18-7284	—	—	—	
185 (262 CID)			A331455 & Sup	& Sup	18-7284	—	—	—	
470	224/L4	1976-1984	4208730	6916778	18-7278	—	—	18-7860	
485	224/L4	1980-1982	5685394	6218036	18-7278	—	—	18-7860	
488	224/L4	1983-1984	6170297	6916778	18-7278	⑦	—	18-7860	
140 (6 CIL)	194/L6	1963	1538930	1725960	18-7256	—	—	—	
150	230/L6	1964-1966	1666495	2048046	18-7256	—	—	—	
160	250/L6	1967-1969	2048022	2770031	18-7278	⑧	—	18-7860	
160	250/L6	1967-1969	2048022	2770031	18-7256	⑨	—	—	
165 (6 CIL)	250/L6	1979-1981	2770032	5813433	18-7278	—	—	18-7860	
200 (6 CIL)	250/L6	1969	2453769	2712072	18-7278	—	—	18-7860	
200 GM			6218462	& Sup	18-7283	—	—	—	
200/5.0L GM			B525982	& Sup	18-7283	—	—	—	
185 (4bb1)	229/V-6	1983-1984	6330183	6919655	18-7284	—	—	—	
175	262/V-6	1987	B527955	B773242	18-7284	—	—	—	
185 (2bb1)	262/V-6	1985-1986	A331455	B527954	18-7284	—	—	—	
205	262/V-6	1985-1987	A331455	B775129	18-7284	—	—	—	
205/4.3L-LX (262 CID)			B527955	& Sup	18-7284	—	—	—	
262 MAG EFI (GEN +)	262/V-6	1996-1997	F803800	K999999	18-8867	—	—	—	
4.3L	262/V-6	1988-1992	B773243	D714106	18-7284	—	—	—	
4.3L (GEN II)	262/V-6	1992-1996	D714107	F802999	18-8867	—	—	—	
4.3L (GEN +)	262/V-6	1998-2010	L012009	& Sup	18-8868	—	—	—	
4.3L EFI (GEN +)	262/V-6	1998-2001	L012009	M299999	18-8861	⑩	—	—	
4.3L MPI	262/V-6	2002-2010	M300000	& Sup	18-8862	⑪	—	—	
4.3LH (GEN+)	262/V-6	1998-2002	L010044	M614999	18-8868	—	—	—	
4.3LX	262/V-6	1988-1992	B775130	D714369	18-7284	—	—	—	
4.3LX (GEN II)	262/V-6	1992-1996	D714107	F802999	18-8867	—	—	—	
4.3LX (GEN +)	262/V-6	1996-1997	F803000	K999999	18-8867	—	—	—	
4.3LXH (GEN +)	262/V-6	1996-1997	F803114	K999999	18-8867	—	—	—	
215 (FORD)	302/V-8	1970-1972	2781153	3563181	18-7267	—	—	—	
215 Ford			3085036	& Inf	18-7267	—	—	—	
215 Ford			3258182	& Sup	18-7267	—	—	—	
225 Ford	302/V-8	1973-1974	3385721	4166999	18-7267	—	—	—	
228 MCM & MIE	305/V-8	1977-1978	4765100	5170008	18-7274	—	—	—	
228 MCM & MIE	305/V-8	1979-1982	5170009	6218461	18-7274	—	—	—	
228 MCM & MIE	305/V-8	1979-1982	5170009	6218461	18-7283	⑫	—	—	
888 (FORD)	302/V-8	1971-1977	3108723	4887829	18-7267	—	—	—	
228	305/V-8	1982-1984	6218462	6899268	18-7283	—	—	—	
230 MIE	305/V-8	1981-1987	5907058	B788151	18-7283	—	—	—	
230/5.0L-GM (IB)			B522506	& Sup	18-7283	—	—	—	
230 GM			6218462	& Sup	18-7283	—	—	—	
230/5.0L-LX GM			B525982	& Sup	18-7283	—	—	—	
230	305/V-8	1985-1987	6899269	B773739	18-7283	—	—	—	
5.0L	305/V-8	1988-1995	B774445	F600999	18-7283	—	—	—	
5.0L (GEN +)	305/V-8	1998-2010	L015751	& Sup	18-8868	—	—	—	
5.0L EFI (GEN +)	305/V-8	1998-2001	L012052	M299999	18-8861	⑬	—	—	
5.0L MIE	305/V-8	1988	B788152	C396832	18-7283	—	—	—	
5.0L MPI ALPHA	305/V-8	2002-2010	M300000	& Sup	18-8862	⑭, ⑮	18-8868 ⑯	—	
5.0L MPI BRAVO	305/V-8	2002-2004	M300000	W059999	18-8862	⑰, ⑱	18-8868 ⑲	—	
5.0L MPI BRAVO	305/V-8	2004-2010	W060000	& Sup	18-8864	⑲	18-8865 ⑳	—	
5.0LX	305/V-8	1988-1995	B773740	F600999	18-7283	—	—	—	
898	305/V-8	1977-1982	4762210	6218461	18-7274	㉑	—	—	
898	305/V-8	1977-1982	4762210	6218461	18-7283	㉒	—	—	
898	305/V-8	1983-1984	6218462	6899057	18-7283	—	—	—	
233 FORD			4500860	& Sup	18-7267	—	—	—	
250	350/V-8	1977	4768000	4908849	18-7274	—	—	—	
255	350/V-8	1975-1976	4175500	4767999	18-7274	—	—	—	
255 MIE (GM)	350/V-8	1975-1980	4175500	5907057	18-7274	—	—	—	
255 FORD			3258728	& Sup	18-7267	—	—	—	
255 GM			5195909	& Sup	18-7274	—	—	—	
260	350/V-8	1978-1982	4908850	6218461	18-7274	㉓	—	—	
260	350/V-8	1978-1982	4908850	6218461	18-7283	㉔	—	—	
260	350/V-8	1983-1987	6218461	& Sup	18-7283	—	—	—	
260 MIE	350/V-8	1981-1987	5907058	B788151	18-7283	—	—	—	

- ① Baja presión de la bomba de elevación
- ② Refrigeración de la bomba de comb. de alta presión
- ③ Bomba comb. con cazoleta filtro arriba
- ④ Bomba comb. con cazoleta filtro abajo
- ⑤ AC bomba combustible
- ⑥ Carter bomba comb.
- ⑦ Bomba comb. mecánica
- ⑧ Usar si bomba comb. tiene vaso comprobador
- ⑨ Usar si bomba comb. tiene tubo
- ⑩ Bomba comb/Kit refrigeración

APLICACIÓN BOMBA COMBUSTIBLE

Model	CID / # CIL	Intervalo años	Desde Número serie	Hasta Número serie	Bomba comb #1	Bomba comb #2	Filtro bomba
260/5.7 GM			B525982	& Sup	18-7283	—	—
260 GM Intraborda			5907058	& Sup	18-7283	—	—
260/5.7L GM (IB)			5907058	& Sup	18-7283	—	—
5.7L-GM			F025000	& Sup	18-7283	—	—
280	350/V-8	1975-1976	4176250	4770199	18-7274	—	—
300MR/TRS GM	350/V-8	1985-1986	6668677	B430367	18-7283	—	—
320 EFI	350/V-8	1987-1989	A543604	C622418	N.L.A	—	—
325-GM			2278747	3640670	18-7275	—	—
330 GM			4623115	& Sup	18-7275	—	—
330 GM/W.B.W.			6083145	& Sup	18-7288-1	—	—
340/7.4L-GM (IB)			5889914	& Sup	18-7288-1	—	—
350 MAG ALPHA	350/V-8	1986-1997	A635178	K999999	18-7823	—	—
350 MAG ALPHA EFI (GEN +)	350/V-8	1996	F800300	K001508	18-7283	—	—
350 MAG ALPHA EFI (GEN +)	350/V-8	1997	K001509	K999999	18-8863	Ⓣ	—
350 MAG BRAVO MPI	350/V-8	1995-1996	F415189	K001500	18-7283	—	—
350 MAG BRAVO MPI	350/V-8	1997	K001501	K999999	18-8863	Ⓣ	—
350 MAG EFI SKI	350/V-8	1994-1997	F215561	K999999	18-8863	Ⓣ	—
350 MAG MPI	350/V-8	1998-2001	L010019	M299999	18-8861	Ⓣ	—
350 MAG MPI ALPHA	350/V-8	2002-2010	M300000	& Sup	18-8862	Ⓣ	18-8868 Ⓣ
350 MAG MPI BRAVO	350/V-8	2002-2004	M300000	W059999	18-8862	Ⓣ, Ⓣ	18-8868 Ⓣ
350 MAG MPI BRAVO	350/V-8	2004-2010	W060000	& Sup	18-8864	Ⓣ	18-8865 Ⓣ
350 MAG MPI HORIZON	350/V-8	2002-2004	M300000	W059999	18-8862	Ⓣ, Ⓣ	18-8868 Ⓣ
350 MAG MPI HORIZON	350/V-8	2004-2007	W060000	A299999	18-8864	Ⓣ	18-8865 Ⓣ
350 MAG MPI HORIZON MIE	350/V-8	1999-2001	L304700	M299999	18-8861	Ⓣ	—
350 MAG MPI HORIZON MIE	350/V-8	2002-2004	M300000	M398371	18-8862	Ⓣ, Ⓣ	18-8868 Ⓣ
350 MAG MPI HORIZON MIE	350/V-8	2004-2007	M398372	A089999	18-8864	Ⓣ	18-8865 Ⓣ
350 MAG MPI MIE	350/V-8	1998-2001	L002008	M299999	18-8861	Ⓣ	—
350 MAG MPI MIE	350/V-8	2002-2004	M300000	M398371	18-8862	Ⓣ, Ⓣ	18-8868 Ⓣ
350 MAG MPI MIE	350/V-8	2004-2007	M398372	A089999	18-8864	Ⓣ	18-8865 Ⓣ
350 MAG MPI MIE	350/V-8	1998-2001	L002008	M299999	18-8861	Ⓣ	—
350 MAG MPI MIE	350/V-8	2002-2004	M300000	M398371	18-8862	Ⓣ, Ⓣ	18-8868 Ⓣ
350 MAG MPI MIE	350/V-8	2004-2007	M398372	A089999	18-8864	Ⓣ	18-8865 Ⓣ
350 MAG MPI SKI	350/V-8	1995-1996	F350583	F799999	18-7283	—	—
350 MAG MPI SKI (GEN +)	350/V-8	1998-2001	L002600	M299999	18-8861	Ⓣ	—
350 MAG MPI SKI (GEN +)	350/V-8	2002-2007	M300000	A089999	18-8862	Ⓣ	18-8868 Ⓣ
350 MAG SKI	350/V-8	1991-1997	D505450	K999999	18-7283	—	—
350 GM			3780450	& Sup	18-7275	—	—
(MAG-TOURNEY SKI)			D505450	& Sup	18-7283	—	—
370 TRS-GM			6721528	& Sup	18-7288-1	—	—
390-GM			2781129 - 2825059	2825059	18-7275	—	—
5.7L	350/V-8	1988-1997	B773305	K999999	18-7283	—	—
5.7L (GEN +)	350/V-8	1998-2010	L010037	& Sup	18-8868	—	—
5.7L EFI	350/V-8	1995-1996	F225560	K001505	18-7283	—	—
5.7L EFI	350/V-8	1997-2001	K001506	M299999	18-8861	Ⓣ	—
5.7L MIE	350/V-8	1988-1997	B788152	K999999	18-7283	—	—
5.7L MIE (GEN +)	350/V-8	1998-2010	L002003	& Sup	18-8868	—	—
5.7L MPI HORIZON MIE	350/V-8	2008-2010	A090000	& Sup	18-8864	Ⓣ	18-8865 Ⓣ
5.7L MPI MIE	350/V-8	2008-2010	A090000	& Sup	18-8864	Ⓣ	18-8865 Ⓣ
5.7L MPI SKI	350/V-8	2008-2010	A090000	& Sup	18-8862	Ⓣ, Ⓣ	18-8868 Ⓣ
5.7L SKI	350/V-8	1985-1997	A338553	K999999	18-7283	—	—
5.7L SKI (GEN +)	350/V-8	1998-2010	L002005	& Sup	18-8868	—	—
5.7LX	350/V-8	1996-1997	F601000	K999999	18-7283	—	—
5.7LX BRAVO EFI (GEN +)	350/V-8	1996	F800300	K001508	18-7283	—	—
5.7LX BRAVO EFI (GEN +)	350/V-8	1997	K001509	K999999	18-8863	Ⓣ	—
5.7LX EFI	350/V-8	1996	F752400	K001505	18-7283	—	—
5.7LX EFI	350/V-8	1997	K001506	K999999	18-8863	Ⓣ	—
5.7 GM (SKI)			B514627	& Sup	18-7283	—	—
5.7L BRAVO (GM)350			B525982	& Sup	18-7283	—	—
BLACK SCORPION SKI	350/V-8	1997	K040001	K999999	18-8863	Ⓣ, Ⓣ	—
BLACK SCORPION SKI	350/V-8	1998-2001	L000000	L679175	18-8861	Ⓣ, Ⓣ	—
BLACK SCORPION SKI	350/V-8	2001-2007	L679176	W698432	18-8861	Ⓣ, Ⓣ	18-8868 Ⓣ
SCORPION 350	350/V-8	2008-2010	W698433	& Sup	18-8861	Ⓣ, Ⓣ	18-8868 Ⓣ
SCORPION 350 EC	350/V-8	2009-2010	W698433	& Sup	18-8864	Ⓣ	18-8864 Ⓣ
233 (FORD)	351/V-8	1975-1977	4173000	4902304	18-7267	—	—
255 (FORD)	351/V-8	1973-1974	3258728	4175499	18-7267	—	—
377 MAG	377/V-8	2008-2010	A300000	& Sup	18-8864	Ⓣ	18-8865 Ⓣ
377 SCORPION MCM	377/V-8	1999-2005	L416146	M907201	18-8861	Ⓣ	—
377 SCORPION SKI	377/V-8	1997-1998	K00656	L600314	18-8861	Ⓣ	—
MX 6.2L MPI	377/V-8	2000-2001	L680003	M299999	18-8861	Ⓣ	—
MX 6.2L MPI	377/V-8	2002-2004	M300000	W059999	18-8862	Ⓣ, Ⓣ	18-8868 Ⓣ
MX 6.2L MPI	377/V-8	2004-2007	W060000	A299999	18-8864	Ⓣ	18-8865 Ⓣ
MX 6.2L MPI HORIZON	377/V-8	2002-2004	M300000	W059999	18-8862	Ⓣ, Ⓣ	18-8868 Ⓣ
MX 6.2L MPI HORIZON	377/V-8	2004-2007	W060000	A299999	18-8864	Ⓣ	18-8865 Ⓣ
MX 6.2L MPI HORIZON MIE	377/V-8	2002-2004	M300000	M398394	18-8862	Ⓣ, Ⓣ	18-8868 Ⓣ
MX 6.2L MPI HORIZON MIE	377/V-8	2004-2010	M398395	& Sup	18-8864	Ⓣ	18-8865 Ⓣ
MX 6.2L MPI MIE	377/V-8	2002-2004	M300000	M398394	18-8862	Ⓣ, Ⓣ	18-8868 Ⓣ
MX 6.2L MPI MIE	377/V-8	2004-2010	M398395	& Sup	18-8864	Ⓣ	18-8865 Ⓣ
MX 6.2L MPI SKI	377/V-8	2002-2010	M317000	& Sup	18-8862	Ⓣ, Ⓣ	18-8868 Ⓣ
MX 6.2L BLACK SCORPION SKI	377/V-8	2001	L670015	L679175	18-8861	Ⓣ	—
MX 6.2L BLACK SCORPION SKI	377/V-8	2001-2007	L679176	W698432	18-8861	Ⓣ, Ⓣ	18-8868 Ⓣ
SCORPION 377	377/V-8	2008-2010	W698433	& Sup	18-8861	Ⓣ, Ⓣ	18-8868 Ⓣ
SCORPION 377 HO EC	377/V-8	2009-2010	A091488	A092170	18-8864	Ⓣ	18-8865 Ⓣ
325	427/V-8	1969-1972	2278747	3780449	18-7275	—	—
330	454/V-8	1977-1981	4623115	6083144	18-7275	—	—
330 WITH B/W	454/V-8	1982-1987	6083145	B816540	18-7288-1	—	—
340 MIE	454/V-8	1981-1987	5889914	B788365	18-7288-1	—	—
350 MIE	454/V-8	1974-1976	3780450	4623109	18-7275	—	—
370 TRS	454/V-8	1978-1987	4179554	B714586	18-7288-1	—	—
400 TRS	454/V-8	1980-1986	4179554	B457644	18-7288-1	—	—
420	454/V-8	1987-1989	A398941	B622418	18-7288-1	—	—
425-GM			A398941	& Sup	18-7288-1	—	—
425	454/V-8	1990-1992	B622419	D725499	18-7288-1	—	—
425 (GEN V)	454/V-8	1992-1993	D763855	D937011	18-8860	—	—
440 TRS	454/V-8	1983-1986	4179554	B485220	18-7288-1	—	—

- ① Baja presión de la bomba de elevación
- ② Refrigeración de la bomba de comb. de alta presión
- ③ Bomba comb. con cazoleta filtro arriba
- ④ Bomba comb. con cazoleta filtro abajo
- ⑤ AC Bomba combustible
- ⑥ Carter bomba combustible
- ⑦ Bomba combustible mecánica
- ⑧ Usar si bomba comb tiene vaso comprobador
- ⑨ Usar si bomba comb. tiene tubo
- ⑩ Bomba combustible/Kit refrigeración

APLICACIÓN BOMBA COMB

Modelo	CID / # CIL	Intervalo Año	Desde Número serie	Hasta Número serie	Bomba comb #1	Bomba comb #2	Filtro bomba
450	454/V-8	1995-1996	F347100	F347277	18-8860	—	—
454 MAG ALPHA	454/V-8	1986-1988	A631894	B785148	18-7288-1	—	—
454 MAG BRAVO GM			B840126	& Sup	18-7288-1	—	—
454 MAG BRAVO	454/V-8	1988-1992	A631894	B785148	18-7288-1	—	—
454 MAG BRAVO	454/V-8	1992-1997	D805069	K999999	18-8860	—	—
454 MAG EFI	454/V-8	1994-1996	F115700	F802349	18-8860	—	—
454 MAG EFI SKI	454/V-8	1995-1996	F215800	F820099	18-8860	—	—
454 MAG MPI	454/V-8	1996	F802350	K147349	18-8860	—	—
454 MAG MPI	454/V-8	1997	K147350	K999999	18-8861	Ⓜ	—
454 MAG MPI	454/V-8	1998-2001	L010029	M024999	18-8861	Ⓜ	—
454 MAG MPI HORIZON MIE	454/V-8	1998-2001	L002200	L674000	18-8861	Ⓜ	—
454 MAG MPI SKI	454/V-8	1996-1997	F820100	K999999	18-8860	—	—
470			5097479	& Inf	18-7278	—	—
470			5097480	& Sup	18-7278	—	—
470			5520115	6218036	18-7278	—	—
470			6218037	& Sup	18-7278	—	—
485			5685394	& Sup	18-7278	—	—
488			6170297	& Sup	18-7278	—	—
525SC	454/V-8	1992-1999	D725809	L415623	18-8860	—	—
7.4L BRAVO	454/V-8	1988-1991	B771113	D603117	18-7288-1	—	—
7.4L BRAVO	454/V-8	1992-1997	D603118	K999999	18-8860	—	—
7.4L EFI MIE	454/V-8	1996-1997	F874815	K999999	18-8863	Ⓜ	—
7.4L MIE	454/V-8	1988-1992	B788366	D715493	18-7288-1	—	—
7.4L MIE	454/V-8	1992-1997	D715494	K999999	18-8860	—	—
7.4L MPI	454/V-8	1998-2001	L010003	M024330	18-8861	Ⓜ	—
7.4L MPI MIE	454/V-8	1995-1997	F563052	K147349	18-8860	—	—
7.4L MPI MIE	454/V-8	1997	K147350	K999999	18-8863	Ⓜ	—
7.4L MPI MIE	454/V-8	1997-2001	L002006	L674613	18-8861	Ⓜ	—
7.4LX BRAVO EFI	454/V-8	1996-1997	F820000	K999999	18-8863	Ⓜ	—
7.4LX BRAVO MPI	454/V-8	1996-1997	F602010	K999999	18-8860	—	—
7.4L W/HURTH (IB)			C391564	& Sup	18-7288-1	—	—
390	482/V-8	1969-1970	2781129	2825059	18-7275	—	—
496 MAG & HO	496/V-8	2001-2004	M025000	W059999	18-8862	Ⓜ, Ⓜ	18-8868 Ⓜ
496 MAG & HO	496/V-8	2004-2010	W060000	& Sup	18-8864	Ⓜ	18-8865 Ⓜ
8.1S MPI MIE & HO	496/V-8	2001-2004	M026000	W089999	18-8862	Ⓜ, Ⓜ	18-8868 Ⓜ
8.1S MPI MIE & HO	496/V-8	2004-2010	W090000	& Sup	18-8864	Ⓜ	18-8865 Ⓜ
465	502/V-8	1992-1994	D456155	F213244	18-7275	—	—
500	502/V-8	1994-1998	F213293	L001772	18-7275	—	—
502 MAG BRAVO	502/V-8	1992-1993	D824589	F114528	18-8860	—	—
502 MAG EFI	502/V-8	1993-1995	D840650	F802599	18-8860	—	—
502 MAG MPI	502/V-8	1996	F802600	K147349	18-8860	—	—
502 MAG MPI	502/V-8	1997	K147350	K999999	18-8863	Ⓜ	—
502 MAG MPI	502/V-8	1998-2001	L017000	M024999	18-8861	Ⓜ	—
600SC	502/V-8	1992-2000	D725676	L601186	18-8860	—	—
8.2L MAG & HO	502/V-8	2010	A340340	& Sup	18-8864	Ⓜ	18-8865 Ⓜ
8.2L MAG & HO MIE	502/V-8	2010	A350802	& Sup	18-8864	Ⓜ	18-8865 Ⓜ
8.2L MIE	502/V-8	1993-1996	D857200	F819619	18-8860	—	—
8.2L MPI MIE	502/V-8	1996-1997	F819620	K147349	18-8860	—	—
8.2L MPI MIE	502/V-8	1997	K147350	K999999	18-8863	Ⓜ	—
8.2L MPI MIE	502/V-8	1998-2001	L002450	L674200	18-8861	Ⓜ	—

- | | |
|--|--|
| Ⓜ Baja presión de la bomba de elevación | Ⓜ Carter bomba comb |
| Ⓜ Refrigeración de la bomba de comb. de alta presión | Ⓜ bomba comb mecánica |
| Ⓜ Bomba comb. con cazoleta filtro arriba | Ⓜ usar si bomba comb. tiene vaso comprobador |
| Ⓜ Bomba comb. con cazoleta filtro abajo | Ⓜ usar si bomba comb. tiene tubo |
| Ⓜ AC Bomba comb. | Ⓜ bomba comb/Kit refrigeración |

SEPARADOR AGUA/COMBUSTIBLE

Los filtros sierra separan hasta un 99.8% de agua emulsionada en la gasolina. Los filtros de 10 micrones separan hasta un 90% de impurezas y pueden ser aplicados para un consumo máximo de 350 litros por hora.

Están indicados para prevenir daños en los motores intraborda y fueraborda de inyección.

- DISEÑO UNIVERSAL -

RECAMBIO DIRECTO PARA MERCURY Y YAMAHA

SOPORTE DEL SEPARADOR DE AGUA/COMBUSTIBLE



Tipo de soporte	Ref #	Reemplaza	Tipo soporte	Ref #	Reemplaza
1/4" Acero inox	18-7777		1/4" Aluminio	18-7853-1	Mercury 89876A3, 55481, 89876
3/8" Acero inox	18-7776		3/8" Aluminio	18-7775	

KITS SEPARADORES AGUA/COMBUSTIBLE



KITS FILTROS 21 MICRONES - PARA MOTORES CARBURADOS

Tipo kit	Ref #	Capacidad de filtrado	Contiene	Reemplaza
1/4" Aluminio (Filtro corto)	18-7848-1	21	1 - 18-7844 filtro & 1 18-7853-1 soporte 2 - 18-4256 1/4" tapones	Mercury - 35-807172A4, Q4, 35-60494A4, 35-805369A4, 35-57250A1, 35-55501A1, 35-52456A1, 35-60494A1, 52444
1/4" Pack aluminio Contiene filtro recambio	18-7848-2	21	2 - 18-7844 filtro & 1 18-7853-1 soporte 2 - 18-4256 1/4" tapones	
1/4" Aluminio (Filtro alto)	18-7852-1	21	1 - 18-7845 filtro & 1 18-7853-1 soporte 2 - 18-4256 1/4" tapones	
1/4" Pack aluminio Contiene filtro recambio	18-7852-2	21	2 - 18-7845 filtro & 1 18-7853-1 soporte 2 - 18-4256 1/4" tapones	
3/8" Aluminio (Filtro alto)	18-7775-1	21	1 - 18-7845 filtro & 1 18-7775 soporte 2 - 18-4264 3/8" tapones	
1/4" Acero inox (Filtro alto)	18-7777-1	21	1 - 18-7845 filtro & 1 18-7777 soporte 2 - 18-4256 1/4" tapones	
3/8" Stainless Steel (Filtro alto)	18-7776-1	21	1 - 18-7845 filtro & 1 18-7776 soporte 2 - 18-4264 3/8" tapones	

KIT FILTROS 10 MICRONES PARA MOTORES DE INYECCIÓN



tipo kit	Ref #	Capacidad de filtrado	Contiene
1/4" Aluminio (Filtro corto)	18-7983-1	10	1 - 18-7944 filtro & 1 18-7853-1 Soporte • 2 - 18-4256 1/4" Tapones
1/4" Aluminio Bonus Pack (Contiene filtro de repuesto)	18-7983-2	10	2 - 18-7944 filtro & 1 18-7853-1 Soporte • 2 - 18-4256 1/4" Tapones
1/4" Aluminio (Filtro largo)	18-7982-1	10	1 - 18-7945 filtro & 1 18-7853-1 Soporte • 2 - 18-4256 1/4" Tapones
1/4" Aluminio Bonus Pack (Contiene filtro de repuesto)	18-7982-2	10	2 - 18-7945 filtro & 1 18-7853-1 Soporte • 2 - 18-4256 1/4" Tapones
1/4" Aluminio (Filtro alta capacidad)	18-7966-1	10	1 - 18-7866 filtro & 1 18-7853-1 Soporte • 2 - 18-4256 1/4" Tapones
3/8" Aluminio (Filtro alto)	18-7986-1	10	1 - 18-7945 filtro & 1 18-7775 Soporte • 2 - 18-4264 3/8" Tapones
1/4" Acero inox (Filtro largo)	18-7984-1	10	1 - 18-7945 filtro & 1 18-7777 Soporte
3/8" Acero inox (Filtro largo)	18-7985-1	10	1 - 18-7945 filtro & 1 18-7776 Soporte • 2 - 18-4264 3/8" Tapones
1/4" Aluminio (Filtro alto)	18-79912	10	1 - 18-79911 & 1 - 18-7853-1



KITS FILTROS10 MICRONES CON VASO DECANTADOR

El vaso transparente Sierra AquaVue™ se usa para fueraborda e instalaciones en cubierta.

El vaso antiinflamable se usa para instalaciones bajo cubierta.

Los filtros con vaso decantador transparente o metálico permiten drenar el agua, alargando la vida útil del elemento filtrante.

Tipo kit	Ref #	Capacidad de filtrado	Contiene
1/4" Aluminio c/ cazoleta de desagüe	18-7951	10	1 - 18-7919 filtro & 1 18-7853-1 soporte 1 - 18-7924 vaso metálico 2 - 18-4256 1/4" tapones
1/4" Acero inoxidable c/ cazoleta de desagüe	18-7938	10	1 - 18-7919 filtro & 1 18-7777 soporte 1 - 18-7924 vaso metálico 2 - 18-4256 1/4" tapones

SOPORTE COMPACTO Y KIT SEPARADOR - PARA PEQUEÑOS FUERABORDAS Y APLICACIONES DE AGUA DULCE

18-7774
SOPORTE ALUMINIO CONTACTO



18-7965-1
10 MICRON COMPACTO
KIT SEPARADOR
Contiene:
1 - 18-7774 soporte
1 - 18-7865 filtro



FILTROS DE REPUESTO



DISEÑO UNIVERSAL - REPUESTO DIRECTO PARA MERCURY

FILTROS DE REPUESTO 10 MICRONES			FILTROS DE REPUESTO 21 MICRONES		
Ref #	Descripción	Reemplaza	Ref #	Descripción	Reemplaza
18-7944	corto - 3.875"	35-807172, 35-802893Q, 35-806771, 35-8053691, 35-805369, 35-604941, 35-60494, 35-57250, 35-55501, 35-52456	18-7844	Corto - 3.875"	35-807172, 35-802893Q
18-7945	Largo - 8.5"	35-802893Q, 35-806771, 35-8053691, 35-805369, 35-604941, 35-60494, 35-57250, 35-55501, 35-52456	18-7845	Largo - 4.35"	35-807172, 35-806771, 35-8053691, 35-60494A4, 35-604941, 35-57250, 35-55501
18-7866	Alta capacidad - 6"				
18-7865	Compacto 10 Micrones				
18-79911	Largo - 8.5"	35-8M0079962			



FILTROS DE REPUESTO 10 MICRONES Y KITS CON VASO DECANTADOR



FILTROS DE REPUESTO			REPUESTO VASOS DECANTADORES	
Ref #	Descripción	Reemplaza	Ref #	Descripción
18-7919	Elemento filtrante	35-809097, 35-8M0103095 Racor S3213	18-7924	Vaso metálico
18-7920	Elemento filtrante	Mercury 35-809099 Racor S3214	KITS FILTROS CAZOLETAS	
18-7947	Elemento filtrante	Racor S3240	Ref #	Descripción
18-7948	Elemento filtrante Para - 320RRAC01	35-886638 Racor S3227	18-7929	Filtro y Vaso metálico Tipo mercury Contiene: 18-7919 filtro, 18-7924 cazoleta
18-7949	Elemento filtrante Para - 660RRAC02	Racor S3232	18-7943	Filtro & Vaso metálico Contiene: 18-7920 filtro, 18-7924 cazoleta
			18-7969	Filtro & Vaso metálico Contiene: 18-7948 filtro, 18-7924 cazoleta



18-7919
FILTRO SEPARADOR
GASOLINA AGUA
 Reemplaza: Mercruiser 35-809097,
 35-8M0103095
 y Racor™ S3213
 Para elementos filtrantes con decantador



18-8955
TAPA DEL SEPARADOR
AGUA/COMBUSTIBLE
 Para: 18-7944 & 18-7945 Tamaño filtro



18-7784
FILTRO COMBUSTIBLE
 Reemplaza:
 Mercruiser 35-11004A1, 35-803897Q1
 Para: 2.5L/3.0L(6229718 & posteriores), Todos MC224 CID
 (6218037 & posteriores), Todos GM 262 CID (A331455 &
 posteriores) con bombas de combustible de carter



18-7977
"GEN III SISTEMA DE
FILTRO COMB.
REFRIGERACIÓN COMB."
 Reemplaza: 35-866171A01
 Para: 350 Mag MPI Alpha/Bravo, 350 Mag MPI Horizon Alpha/
 Bravo, 350 Mag MPI Horizon MIE, 350 Mag MPI MIE, 496 MAG,
 496 MAG H.O., 5.0 MPI Alpha/Bravo, 8.1L Inboard, 8.1L Inboard
 H.O., MX 6.2L MPI Alpha/Bravo, MX 6.2L MPI Horizon Alpha/
 Bravo, MX 6.2L MPI Horizon MIE, MX 6.2L MPI MIE



18-7964
FILTRO KIT TRANSMISIÓN
 Reemplaza: 35-815419, 8791014241,
 879194241, 35-813405A1, 35-813405,
 F19608751, FFF001138
 Para: Mercruiser V-8 Intraborda con transmisión Hurt



18-7855
FILTRO COMBUSTIBLE
 Reemplaza: 1397-2150
 Rochester Carb entrada



18-7717
FILTRO ELEMENTO
 Reemplaza: 35-93568
 Para: Carburadores Rochester 2 bbl & 4 bbl



18-7859
FILTRO COMBUSTIBLE
 Reemplaza: 35-53336,
 3302-9033, 35-53336Q
 Para: Mayoría GM In línea 4 & 6 cilindro, Ford & Gm
 V-8's hasta 400 HP y todos Mercruiser 224 CID



18-7721
FILTRO COMBUSTIBLE
 Reemplaza: 35-864572
 Todos motores MPI & EFI con bomba de empuje, 8.1L &
 496cid, para 3/8" DI línea combustible



18-7860
FILTRO COMBUSTIBLE
 Reemplaza: 35-49088A2,
 35-49088Q2, 35-49088
 F18390006
 (Usado en bomba combustible 18-7278)
 Para: En línea 4 & 6 cilindros motores



18-7869
FILTRO COMBUSTIBLE
 Usa filtro 18-7859
 Reemplaza: 1397-8767, 1397-8545
 Para:

Modelo/HP	Serie #
GM 2.5L/3.0L	6229718 & post
GM 5.0L/5.7L	6218462 & post
Todos 205	A331455 & post
228 HP	6021784 & post
330 HP	6083145 & post
GM 255	590768 & post
5.7L SKI 340,230 & 260 Intrabordas	TODOS



18-7873
FILTRO COMBUSTIBLE
 Reemplaza: 35-808275
 Para: Modelos D7.3/270 Bravo & MIE Diesel
 Motores 1994-96



18-79901
VST FILTRO
 Reemplaza: 66L-13915-00-00
 Para: 454 EFI(GenV) GM 1994-96
 454 EFI (SKI)(Gen V) GM 1995
 454 Mag Bravo MPI (Gen VI) GM 1996-97
 454 Mag MPI (SKI)(Gen VI) GM 1996-97
 502 EFI (Gen V) GM 1993-95
 502 Mag MPI (Gen VI) GM 1996
 7.4L MIE MPI (LH) Gen V GM 1995-96
 7.4L MIE MPI (LH) Gen VI GM 1996-97
 7.4LX Bravo MPI (Gen V) GM 1996
 7.4LX Bravo MPI (Gen VI) GM 1996-97
 8.2L MIE MPI (LH) Gen VI GM 1996-97



18-6457
POLEA PLÁSTICO
 Reemplaza: 807757T
 3" DE Serpentin para ancho de correa 13/16" ,
 Para último modelo motores GM V6 & V8



18-3506
BOMBA DE CIRCULACIÓN
 Reemplaza: 46-879194401
 Para: V6 MCM SN: 1A063240 (2007), Nuevos 4.3L sin agujero bypass agua
 - ACTUAL



18-3593
BOMBA AGUA
 Reemplaza: 884727, 884727001, 880817, 814755, 65142A1, 65142, 52353, 37369, 35957, F2774666, FI1100785, FI1001079
 Último Modelo 4 cil GM requieren adaptador de manguera



18-3575
BOMBA CIRCULACIÓN AGUA (Bi-Direccional)
 Replaces: 65142A1, 884727001, 844727, 880817, 814755, 65142, 52353, 37369, 33957, F2774666, FI1100785, FI1101079
 Para: GM En línea (4 & 6 Cil.)



18-3577-1
BOMBA AGUA CIRCULACIÓN (Bi-Direccional)
 Reemplaza: 67859, 17670, 811573, 850454, 8504541, 878342, 850454002, 59972, 54534, 49139, F6269358, FI1100997, FI1101053
 Para: bloques grandes GM



18-3573
BOMBA AGUA CIRCULACIÓN
 Todos 8.1L bloques grandes GM
 Reemplaza: 883514, 883925
 Para motores con tapa distribución de plástico



18-3584
BOMBA AGUA CIRCULACIÓN
 Reemplaza: Mercruiser 71683A1, 883885, 71683, 58086, 56879
 Mercruiser 215 to 255 & 888
 Para: Motores Ford bloques pequeños V-8.



18-3599-1
BOMBA AGUA CIRCULACIÓN
 Reemplaza: Mercruiser 60658, 811841, 850399, 8503991, 17437, 878341, 850399002, 54793, 52226, 37951, 35341, FI1101292, FI1101208, FI1100742
 Para motores GM V-6 & bloques pequeños V-8



18-3007
18-3007-10^①
IMPULSOR
 Reemplazar: 47-89983, 4789983T
 Para 60 HP



18-3016-1
KIT IMPULSOR
 Con junta
 Reemplaza: 47-862232A2, 8M0104229
 Para: Último modelo Bravo & High Performance. Incluye 350 Mag., 4.3L., 496 Mag., 5.0L., 8.1S y MX 6.2L



18-3017
18-3017-10^①
IMPULSOR
 Reemplaza: 47-89984, 47-899842, 47-89984T3, 47-89984T4, 47-899844, 47-30221, 47-65960, 47-85460
 Para todos #1, R, MR, Alpha Units hasta S/N D494568.
 Además para bomba salada: 190 IB S/N 1564539-1720903
 225 IB S/N 1539620-2278646



18-3056
18-3056-10^①
IMPULSOR
 Reemplaza: 47-43026-2
 Para Alpha I-Generation 2
 S/N D494569 & encima
 Mercruiser Vazer





















18-3087
IMPULSOR
 Reemplaza: 47-59362, 47-59362T

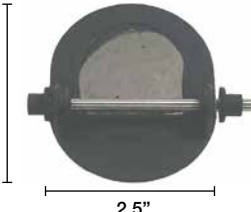
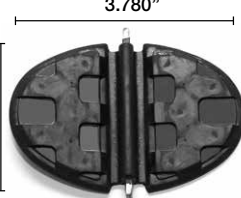

18-3109
TUBO GUIA
 Reemplaza: 23-29804, 23-29804T, 23-52928
 (use con 18-3116 alojamiento)



18-3110
CASQUILLO
 Reemplaza: 26-38970, 26-36557A1, 26-29677
 (Ref 18-3116 alojamiento)

 <p>18-3114 CASQUILLO IMPULSOR Reemplaza: 48752, 48752T (Incluido en 18-3116)</p>	 <p>18-3117 PLATINA IMPULSOR Reemplaza: 32435, 324351, 30605 Para #1 Unidades hasta S/N D494568</p>	 <p>18-3122 PLATINA IMPULSOR Reemplaza: 817276, 8172761, 8172763 Para Alpha I - Generation 2 S/N D494569 & ant</p>		
 <p>18-3350 PLATINA DESGASTE Reemplaza: 72778, 94576</p>	 <p>18-3351 PLATINA DESGASTE Reemplaza: 72777, 94916</p>	 <p>18-3293 CHAVETA Reemplaza: 28-43037</p>		
 <p>18-3151 ALOJAMIENTO Reemplaza: 816597</p>	 <p>18-3417 BASE BOMBA AGUA Reemplaza: 46-57234A1</p>	 <p>18-3420 BASE BOMBA AGUA Reemplaza: 46-44292A3, 46-44292Q03, 46-44292T1</p>		
 <p>18-3421 BASE BOMBA AGUA Reemplaza: 46-48748A1</p>	 <p>18-3116 BOMBA AGUA ALOJAMIENTO Reemplaza: 46-96418, 46-96148A1, 46-96148T1, 46-64141A1, 46-48743A1</p>	 <p>Pack. de 2 6.125" 2.360" 18-2732 18-2732-9① VÁLVULA DE ESCAPE ANTI-RETORNO Reemplaza: 807166A3</p>		
 <p>3.175" 2.5" 18-2733 VÁLV. ESCAPE ANTI-RETORNO Reemplaza: 92802, 99370A2</p>	 <p>3.780" 3" 18-2727 VÁLVULA DE ESCAPE ANTI-RETORNO Reemplaza: 60930</p>	 <p>18-3220 TUBO DE AGUA Reemplaza: 32-54236 Para #1 -R/MR/Alpha</p>	 <p>18-3221 TUBO DE AGUA Reemplaza: 32-814384, 32-860220 Para Gen II</p>	
 <p>18-3222 TUBO DE AGUA Reemplaza: 23-816583 Para Gen II</p>	 <p>Pack de 5 18-3226 18-3226-9① TORNILLO BOMBA IMPULSOR Reemplaza: 10-30720 Para R unidades</p>	 <p>Pack de 5 18-3227 18-3227-9① CLAVIJA BASE BOMBA Reemplaza: 17-35973 Para R/MR, Alpha I</p>	 <p>Pack de 5 18-3229 18-3229-9① TORNILLO Reemplaza: 10-28668 Para MR/Alpha</p>	 <p>18-3197 TORNILLO Reemplaza: 10-76156, 10-67373</p>

① Precio por pack



18-3160
BOMBA AGUA MAR, BRONCE
 Reemplaza: 46-862914A13
 Use impulsor 18-3016-1



18-3600
BOMBA AGUA MAR
 Reemplaza: 46-72774A32, 46-72774A11, 46-73823A7, 46-63450A2, 46-59112A2
 Para: Motores V8 con V-Belt y 2 piezas bomba
 Use kit reparador 18-3155



18-36001
BOMBA AGUA MAR
 Reemplaza: 46-807151A12
 Para: Motores V6 & V8 con correa y 1 pieza bomba
 Use kit reparador 18-3237



18-3155
KIT REPARACIÓN BOMBA AGUA
 Reemplaza: 47-72774A89
 Para: Bravo bomba agua mar con 2 piezas alojamiento



18-3216
KIT IMPULSOR
 Reemplaza: 47-59362A4
 Para: 1996-97 7.4L MIE MPI(LH) Gen VI GM 454 V8, 1996-97, 7.4L TBI MIE(LH) Gen VI GM 454 V8, 1996-97 8.2L MIE MPI(LH) Gen VI GM 502 V8.



18-3318
KIT BOMBA AGUA
 Reemplaza: 47-59362Q08
 Para: 1 plástico y 2 piezas cuerpos bomba



18-3237
KIT REPARACIÓN IMPULSOR
 Para: Bravo I, II, III (1988 & sup) B664190 & sup se adapta a bravo con alojamiento de una pieza
 —CONTIENE—

Ref #	Desc.	O.E. #	Cant.
18-3087	Impulsor	47-59362	1
18-3350	Plat. desg.	94576	1
18-7163	Aro tórico	25-33465	1

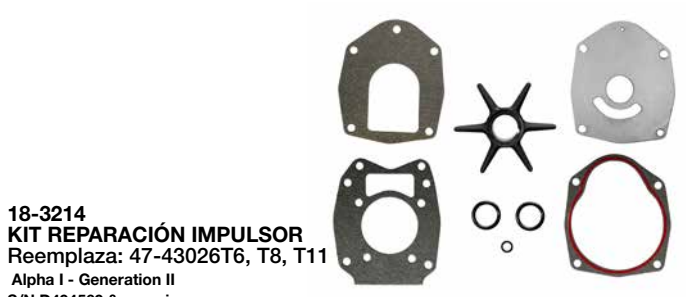

18-3214
KIT REPARACIÓN IMPULSOR
 Reemplaza: 47-43026T6, T8, T11
 Alpha I - Generation II
 S/N D494569 & superiores
 Mercruiser Vazer
 Para similares Kit con alojamiento superior, order 18-3147

18-3214D

—CONTIENE—

Ref #	Desc.	O.E. #	Cant.
18-2564	Junta impulsor	22-43033-1, 27-43033-1	1
18-2565	Junta impulsor	27-43047-1	1
18-2566	Junta impulsor	27-817277	1
18-2944	Arandela	12-19183	1
18-3056	Impulsor	47-43026-1, 47-43026-2	1
18-3122	Platina impulsor	817276	4
18-7420	Aro tórico	25-21836	1



18-3217
KIT IMPULSOR
 Para #1 Units hasta S/N D494568
 (Similar a #46-96148A5 sin base ni alojamiento)

18-3217D

—CONTIENE—

Ref #	Desc.	O.E. #	Cant.
18-3109	Tubo agua	23-29804	1
18-3017	Impulsor	47-89984	1
18-2919	Junta	27-42631-1	1
18-3110	Casquillo	26-38970	1
18-2945	Reten	12-19183	2
18-2826	Junta	27-85610-1	1
18-2914	Junta	27-85608-1	1
18-2915	Junta	27-85609-1	1
18-2944	Junta	26-45577	1
18-3117	Platina	32435	1
18-7158	Aro tórico	25-30613	1
18-7162	Aro tórico	25-33145	1
18-7173	Aro tórico	25-30224	1
18-7176	Aro tórico	25-90011	1
18-2801	Junta bomba agua	27-32438	1
18-7196	Aro tórico	25-38099	1
18-7426	Aro tórico	35-30271	1



18-3150
KIT BOMBA AGUA
 Reemplaza: 46-807151A14, 46-807151A7
 Para: Bravo



18-3309
KIT BOMBA AGUA
 Para: Bravo
 —CONTIENE—

Ref #	Desc.	O.E. #	Cant.
18-3350	Platina desgaste	94576	1
18-3351	Platina desgaste	94916	1
18-3087	Impulsor	47-59362	1
18-0386	Junta cuerpo	27-94914	2
18-0916	Junta bomba agua	27-805215-1	1



18-3147
KIT BOMBA AGUA
 Reemplaza: 817275T4, 817275K05
 Para: Gen II-inf s/n D469859 y sup
 Para similares kit sin alojamiento superior, order 18-3214

— CONTIENE —

Ref #	Desc.	O.E. #	Cant.
18-3109	Tubo guía	23-29804	1
18-3017	Impulsor	47-89984	1
18-3116	alojamiento	46-96148A1	1
18-2919	Junta base bomba	27-42631-1	1
18-3110	Casquillo	26-38970	1
18-2945	Junta tapón de vaciado	26-20260, 12-19183	2
18-2826	Junta base bomba agua	27-85610-1	1
18-2914	Junta inf. bomba a platina desgaste	27-85608-1	1
18-2915	Junta sup. bomba a platina desgaste	27-85609-1	1
18-2944	Retén	26-45577	1
18-3117	Platina	32435	1
18-7158	Aro tórico	25-30613	1
18-7162	Aro tórico	25-33145	1
18-7173	Aro tórico	25-30224	1
18-7176	Aro tórico	25-90011	1
18-2801	Junta bomba agua	27-32438	1
18-7196	Aro tórico	25-38099	1
18-7426	Aro tórico	35-30271	1



18-3517
KIT BOMBA AGUA
 Sin base
 Reemplaza: 46-96148A5, 46-60367A1, 46-96148A8

— CONTIENE —

Ref #	Desc.	O.E. #	Cant.
18-3109	Tubo guía	23-29804	1
18-3017	Impulsor	47-89984	1
18-3116	Alojamiento	46-96148A1	1
18-3420	Base bomba agua	46-44292A3	1
18-2919	Junta base bomba agua	27-42631-1	1
18-3110	Casquillo	26-38970	1
18-2945	Junta tapón de vaciado	12-19183	2
18-2826	Junta base bomba agua	27-85610-1	1
18-2914	Junta inf. bomba a platina desgaste	27-85608-1	1
18-2915	Junta sup. bomba a platina desgaste	27-85609-1	1
18-2944	Retén	26-45577	1
18-3117	Platina	32435	1
18-7158	Aro tórico	25-30613	1
18-7162	Aro tórico	25-33145	1
18-7173	Aro tórico	25-30224	1
18-7176	Aro tórico	25-90011	1
18-2801	Junta bomba agua	27-32438	1
18-7196	Aro tórico	25-38099	1
18-7426	Aro tórico	35-30271	1



18-3320
KIT BOMBA AGUA
 Para: unidades MR/Alpha I
 S/N 6854393-OD469858

— CONTIENE —

Ref #	Desc.	O.E. #	Cant.
18-3109	Tubo guía	23-29804	1
18-3017	Impulsor	47-89984	1
18-3116	Alojamiento	46-96148A1	1
18-3421	Base bomba agua	46-48748A1	1
18-2919	Junta base bomba de agua	27-42631-1	1
18-3110	Casquillo	26-38970	1
18-2945	Junta tapón de vaciado	12-19183	2
18-2826	Junta base bomba de agua	27-85610-1	1
18-2914	Junta inf. bomba a platina a desgaste	27-85608-1	1
18-2915	Junta sup. bomba a platina desgaste	27-85609-1	1
18-2944	Retén	26-45577	1
18-3117	Platina	32435	1
18-7158	Aro tórico	25-30613	1
18-7162	Aro tórico	25-33145	1
18-7173	Aro tórico	25-30224	1
18-7176	Aro tórico	25-90011	1
18-2801	Junta bomba agua	27-32438	1
18-7196	Aro tórico	25-38099	1
18-7426	Aro tórico	35-30271	1

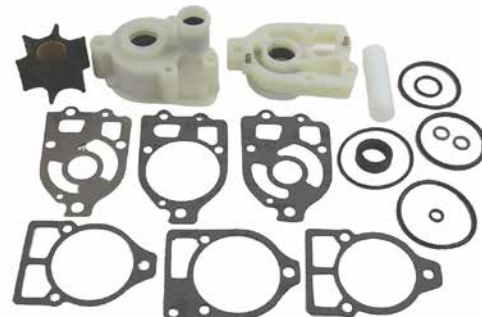

18-3321
KIT BOMBA AGUA
 Para: #1 Units con enjuague
 S/N 2495186-2763441

— CONTIENE —

Ref #	Desc.	O.E. #	Cant.
18-3109	Tubo guía	23-29804	1
18-3017	Impulsor	47-89984	1
18-3116	alojamiento	46-96148A1	1
18-2919	Junta base bomba agua	27-42631-1	1
18-3417	Base bomba agua	46-57234A1	1
18-3110	Casquillo	26-38970	1
18-2945	Junta tapón de vaciado	12-19183	2
18-2826	(Junta) base bomba agua aloj. engranaje	27-85610-1	1
18-2914	Junta inf. bomba a platina	27-85608-1	1
18-2915	Junta sup. bomba a platina	27-85609-1	1
18-2944	Retén	26-45577	1
18-3117	Platina	32435	1
18-7158	Aro tórico	25-30613	1
18-7162	Aro tórico	25-33145	1
18-7173	Aro tórico	25-30224	1
18-7176	Aro tórico	25-90011	1
18-2801	Junta bomba agua	27-32438	1
18-7196	Aro tórico	25-38099	1
18-7426	Aro tórico	35-30271	1
18-2919	Junta bomba de agua	27-46231-1	1

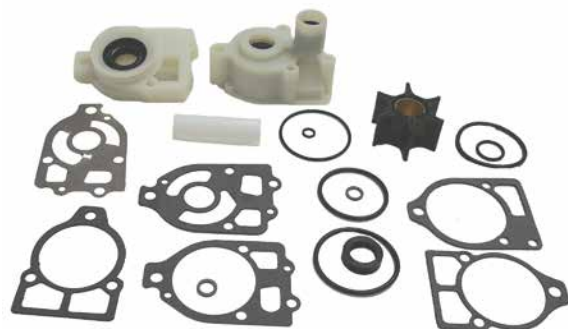

18-3317
KIT BOMBA AGUA
 Para: #1/R Units sin enjuague
 S/N 2763442-6854392

KIT BOMBA AGUA COMPLETA, KIT REPARACIÓN, APLICACIÓN IMPULSOR

Modelo	Serie Número	Kit bomba agua completo	Bomba alojamiento sup. Housing	Kit bomba superior	base bomba agua	Kit impulsor rep. (no alojamiento)	Impulsor
#1 con tornillo de plástico enjuague	2495186 - 2763441	18-3321	18-3116	18-3517	18-3421	18-3217	18-3017
#1 sin tornillo de plástico enjuague	2763442 - 6854392	18-3317 ①	18-3116	18-3517	18-3417 ①	18-3217	18-3017
MR/ALPHA I	6854393 - OD594568	18-3320	18-3116	18-3517	18-3420	18-3217	18-3017
ALPHA I - Generation II & Vazer	OD494569 & superior	18-3147	--	18-3570	--	18-3214	18-3056
BRAVO/Intraborda con cuerpo bomba plástico	3040411 & superior	--	--	18-3150	--	18-3318	18-3087
BRAVO/Intraborda con cuerpo bomba bronce	OM100001 & superior	--	--	18-3160	--	18-3016-1	--

① Modelos retrofijados con Alpha (sin pasador precarga) usar partes Alpha (18-3320 y 18-3420)

DESPIECE BOMBA AGUA II GENERACIÓN

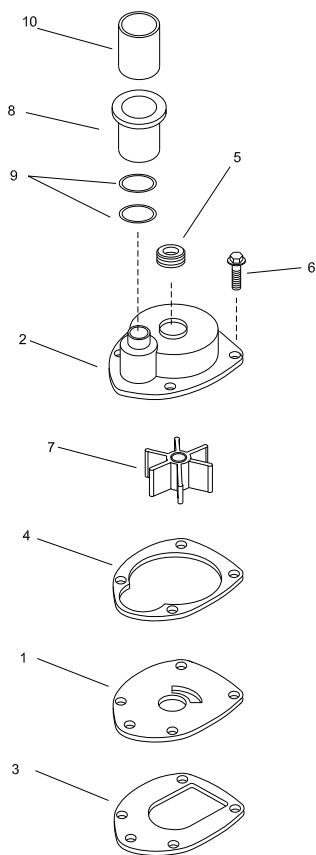

Sequence	Description	Part #	O.E. #	Qty.
1	Platina impulsor	18-3122	817276	1
2	Cuerpo bomba	N.S.S.	817275A1	1
3	Junta, Base	18-2564	27-43033-1	1
4	Junta, alojamiento	18-2566	27-817277	1
5	Retén	18-2599	26-816575A2	1
6	Tornillo	N/D	10-816928	4
7	Impulsor	18-3056	47-43026-2	1
8	Acoplamiento	18-3151	47-43026T11	1
9	Aro tórico	18-7420	25-21836	2
10	Manguito	18-3222	23-816583	1

DESPIECE BOMBA DE AGUA MR ALPHA

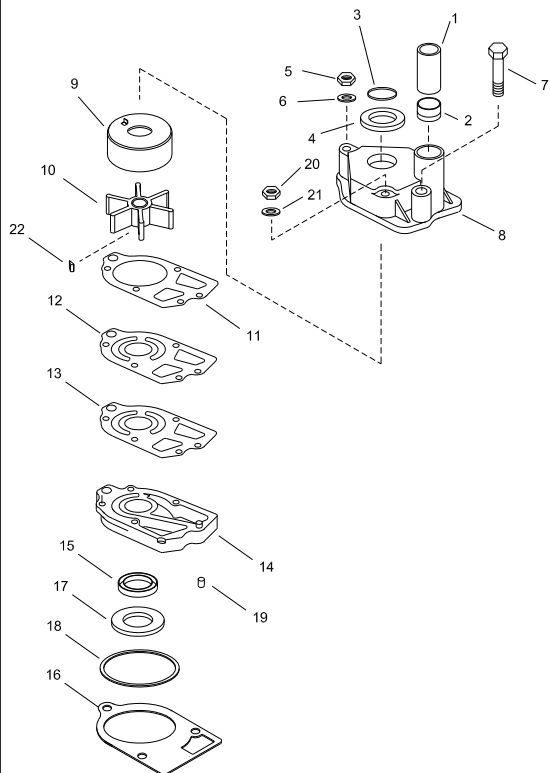

Sequence	Description	Part #	O.E. #	Qty.
1	Casquillo	18-3109	23-29804	1
2	Retén	18-3110	26-38970	1
3	Aro superior	18-7158	25-30613	1
4	Aro	18-7426	25-30271	1
5	Tuerca	N/A	11-13436	1
6	Arandela	18-4270	12-36001	3
7	Tornillo	N/A	10-96411	1
8	Alojamiento	18-3116	46-96148A1	1
9	Alojamiento	18-3114	48752T	1
10	Impulsor	18-3017	48752	1
11	Junta	18-2915	47-89984	1
12	Pletina	18-3117	27-85609-1	1
13	Junta	18-2914	27-85608-1	1
14	Base	18-3420	46-44292A3	1
15	Retén aceite	18-2013	26-16977	1
16	Junta	18-2919	27-42631-1	1
17	Retén aceite	18-2014	26-89238	1
18	Aro	18-7176	25-90011	1
19	Pasador	N/A	17-42836	1
20	Tuerca	N/A	11-13438	1
21	Arandela	18-4275	12-29245	2
22	Pasador	N/A	28-56654	1

DESPIECE BOMBA DE AGUA R/MR

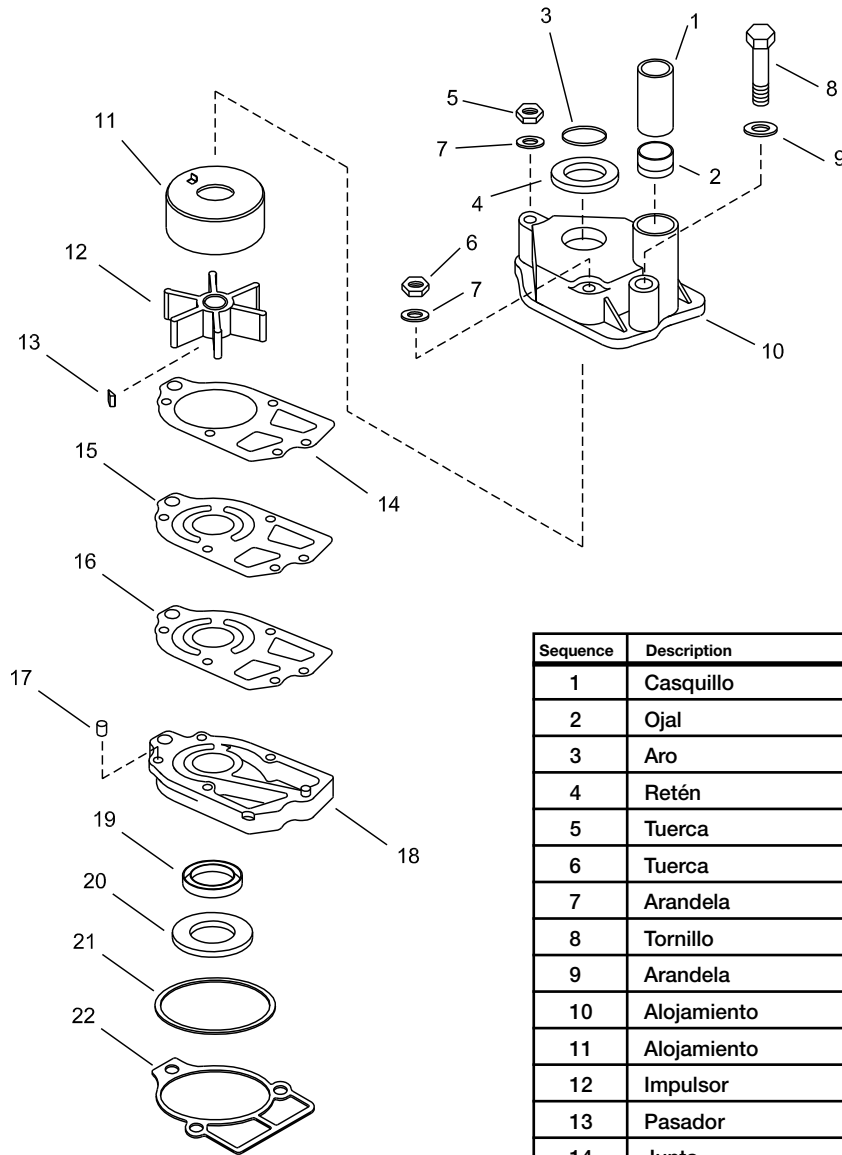

Sequence	Description	Part #	O.E. #	Qty.
1	Casquillo	18-3109	23-29804	1
2	Ojal	18-3110	26-38970	1
3	Aro	18-7158	25-30613	1
4	Retén	18-7426	25-30271	1
5	Tuerca	18-3723	11-45592	1
6	Tuerca	18-3722	11-20361, 11-35888	2
7	Arandela	18-4275	12-29245	3
8	Tornillo	18-3226	10-30720	1
9	Arandela	18-4270	12-36001	1
10	Alojamiento	18-3116	46-96148A1	1
11	Alojamiento	18-3114	48752	1
12	Impulsor	18-3017	47-89984	1
13	Pasador	N/A	28-56654	1
14	Junta	18-2915	27-85609-1	1
15	Platina	18-3117	32435	1
16	Junta	18-2914	27-85608-1	1
17	Pasador	18-3227	17-35973	1
18	Base	18-3417	46-57234A1	1
19	Retén aceite	18-2013	26-16977	1
20	Retén aceite	18-2014	26-89238	1
21	Aro	18-7162	25-33145	1
22	Junta	18-2826	27-85610-1	1



18-3549
TERMOSTATO
Reemplaza: 14586
120°



18-3550
TERMOSTATO
Reemplaza: 59078,
59078A1
140°



18-3551
TERMOSTATO
Reemplaza: 32728,
35884, 59137, 59137A1,
8072521, 8072531,
807252T1, 8M0089715
142°



18-3552
TERMOSTATO
Reemplaza: 76270, 76270T
160°



18-3555
TERMOSTATO
Reemplaza: 99155A1,
99155T2
160°



18-3557
TERMOSTATO
Reemplaza: 47594
143°



18-3649
TERMOSTATO
Reemplaza: 8072522,
807252T2, 8052732,
8M0091470
160°



18-43015
TERMOSTATO
Reemplaza: Mercury 864493
Para: Mercuriser MCM 4.3L MPI, 5.0L
MPI y MX6.2L con escape seco y refrigeración
cerrada.



18-43017
TERMOSTATO
Reemplaza:
Mercury 863358T,
8M0074922
Para: Mercuriser 496 Mag & HO,
8.1L MIE & HO



18-3568
KIT TERMOSTATO
Reemplaza : 99155T1

Modelo	Año	Serie #
5.7MIE	1998-2001	OL002003 & Sup
MX6.2L MPI	2000-2001	OL680003 & Sup
454 Horizon MIE	1998-2001	OL002200 & Sup
502 Mag. MPI	1998-2001	OL017000 & Sup



18-3644
KIT TERMOSTATO
—CONTIENE—

Ref #	Descripción	O.E.#
18-3649	Termostato 160°	807252T2
18-2553	Termostato Junta tapa	27-47510
18-2917	Termostato Junta tapa	27-53045-1



18-3646
KIT TERMOSTATO
Reemplaza: 807252Q3, 807252T6
—CONTIENE—

Ref #	Descripción	O.E.#
18-3551	Termostato	59137
18-2917	Junta Termostato alojamiento	27-53045-1, 27-33918
18-2844	Junta tapa termostato	27-48818-1
18-2553	Junta tapa termostato	27-47510
18-2834	Junta tapa termostato	27-60208



18-3647
KIT TERMOSTATO
Reemplaza: 807252Q5, 807252T8
—CONTIENE—

Ref #	Descripción	O.E.#
18-3649	Termostato	807252-2
18-2844	Junta tapa termostato	27-48818-1
18-2552	Junta tapa termostato	27-33179-2
18-2553	Junta tapa termostato	27-47510
18-7173	Aro tórico	25-30224
18-2917	Junta tapa termostato	27-53045-1, 27-33918



18-3648
KIT TERMOSTATO
160°

Ref #	Descripción	O.E.#
18-2831	Junta termostato	27-47590-1
18-3550	Termostato	59078



18-3650
KIT TERMOSTATO
—CONTIENE—

Ref #	Descripción	O.E.#
18-2831	Junta termostato	27-47590-1
18-3550	Termostato	59078



18-3651
KIT TERMOSTATO
—CONTIENE—

Ref #	Descripción	O.E.#
18-2554	Junta tapa termostato	27-90556
18-2553	Junta tapa termostato	27-47510
18-2834	Junta tapa termostato	27-60208
18-2844	Junta tapa termostato	27-48818-1
18-3551	Termostato	59137



18-3652
KIT TERMOSTATO
—CONTIENE—

Ref #	Descripción	O.E.#
18-2555	Junta tapa termostato	27-89656-1
18-2843	Junta tapa termostato	27-74830
18-3552	Termostato	76270



18-3667
KIT TERMOSTATO
—CONTIENE—

Ref #	Descripción	O.E.#
18-2555	Junta tapa termostato	27-89656-1
18-3555	Termostato	99155A1



18-3668D
KIT TERMOSTATO
Reemplaza: 807252T4, 807252Q4
—CONTIENE—

Ref #	Descripción	O.E.#
18-2552	Junta tapa termostato	27-33179-2
18-2553	Junta tapa termostato	27-47510
18-2554	Junta tapa termostato	27-41812
18-3551	Termostato	59137
18-7173	Aro tórico	25-30224
18-2917	Junta alojamiento termostato	27-53045-1, 27-33918

APLICACIONES TERMOSTATOS EMPIEZAN EN LA SIGUIENTE PÁGINA
 ① Referencias acabadas en D envasadas - Referencias sin D no envasadas



18-1977-1
TERMOSTATO ALOJAMIENTO
 Reemplaza: 47441, 47441A1
 Para 225, GM 260, 228, 898/198,
 185R, 898R, 228R, 2GR



18-1989
TERMOSTATO ALOJAMIENTO
 Reemplaza: 87290A4, 861006A1
Acero inox
 Use 18-1989K Kit servicio termostato
 para piezas de repuesto



18-1993
TERMOSTATO ALOJAMIENTO
 Reemplaza: 47587, 47587A2, 47588,
 60372A1, 60372A2, 60908A2, 861493A3,
 861493A07



18-1994
TERMOSTATO ALOJAMIENTO
 Reemplaza: 8M0061381
 Para: Acero inox Version use 18-1989



18-3530-1
TERMOSTATO ALOJAMIENTO
 Reemplaza: 860256A4, 860256A2
 Para: GM V6 y V8 (305 & 350 ci)



18-3531
TERMOSTATO ALOJAMIENTO
 Reemplaza: 861188A1, 807074A1,
 808064A1
 Para: MCM/MIE GM V-6 & V-8 305,350,454 & 502 cid
 motores con sistemas de refrigeración cerrado



18-1910
KIT TERMOSTATO ALOJAMIENTO
 Reemplaza: 47587, 47587A2, 47588,
 60372A1, 60372A2, 63908A2, 861493A07,
 861493A3
 Para: 3.0L GM 1999-Sup, S/N 0L340999-inf



18-1989K
KIT SERVICIO TERMOSTATO
 Kit servicio para 18-1989 alojamiento termostato



18-1508
RETÉN TERMOSTATO
 Reemplaza: 25-8071341
 Para: Vazer (2007 & SUP), GM
 V6 & V8 con cierre del sistema
 de alojamiento (1996 & SUP)

APLICACIÓN TERMOSTATO

Motores / Modelo	CID / # CIL	Intervalo Año	Desde Nº Serie #	Hasta Nº serie #	Alojamiento	Tapa termostato	Termostato & Kit juntas	Termostato	Requiere juntas	Requiere Juntas - Design II	Requiere Juntas - Diseño III
ROVER			3140000	SUP	—			18-3551	—		
60	68/L4	1965-1968	1887079	2049044				18-3551			
80	80/L4	1966-1969	2049045	2851423				18-3551			
90	96/L4	1970-1972	2851424	3226957				18-3557	18-2831		
100 VASER	98/L4	2007-2010	w995000	& SUP					18-1508		
110	153/L4	1963-1966	1537370	2044033		④		18-3551			
110	153/L4	1963-1966	1821720	2044033		⑥		18-3551			
120	153/L4	1964-1972	1666601	3377340		④		18-3551			
120	153/L4	1964-1966	1725593	2046624		⑥		18-3551			
120	153/L4	1967	2046625	2324346		⑥		18-3551			
120	153/L4	1968-1972	2324347	3377340	18-3650	⑥, ③	18-3650	18-3550	18-2831		
120	153/L4	1972-1986	3377341	B531853	18-3650	③	18-3650	18-3550	18-2831		
2.5L	153/L4	1987-1989	B531854	C853255	18-3650	③	18-3650	18-3550	18-2831		
140	181/L4	1968-1986	2508261	B450800	18-3650	③	18-3650	18-3550	18-2831		
140 (6 CIL)			1538930	1723960	—			18-3551			
3.0L	181/L4	1987-1989	B450801	C856558	18-3650	③	18-3650	18-3550	18-2831		
3.0L, FWC	181/L4	1990-2010	C856559	SUP		⑥		18-3647	18-3649		
3.0L	181/L4	1990-1994	C856559	F603999	18-3650	⑦, ③		18-3650	18-3550	18-2831	
3.0L	181/L4	2000-2010	L341000	& UP		⑦		18-3647	18-3649	18-2552	
3.0L	181/L4	1998-2000	L010042	L340999	18-3650	⑦, ③		18-3650	18-3550	18-2831	
3.0L MPI	181/L4	2008-2010	A072812	& SUP		⑥		18-3647	18-3649	18-2552	
3.0L MPI FWC	181/L4	2008-2010	A072812	& SUP		⑥		18-3647	18-3649		
3.0LX, FWC	181/L4	1990-1997	C856559	K999999		⑥		18-3647	18-3649		
3.0LX	181/L4	1990-1997	C856559	K999999	18-1910	⑦, ③	18-3650	18-3550	18-2831		
150			1666495	2048046	—			18-3551			
160			2048022	2770031	—			18-3551			
160			2048022	2233574	—			18-3557			
160			2326069	2770031	—			18-3557	18-2831		
165			2770032	5813433	—		18-3650	18-3550	18-2831		
165	224/L4	1987	B434941	B774251	—		18-3667	18-3555	18-2555		
165			6916779	SUP	—		18-3667	18-3555	18-2555		

- ① Diseño I
- ② Diseño II
- ③ Diseño III
- ④ Aluminio escape Manifold
- ⑤ Colector escape Manifold
- ⑥ Refrigeración cerrado
- ⑦ Refrigeración estándar
- ⑧ Con bola retención
- ⑨ Sin bola retención

- ⑩ SN 4167000 & Sup
- ⑪ Termostato aloj. Original aparece como la NLA.
Kit actualización 87290A23
- ⑫ Termostato aloj. original aparece como la NLA.
Kit actualización 90736A24
- ⑬ Termostato alojamiento kit completo
- ⑭ Solo 3 puntos y sistema de drenaje
- ⑮ Sistema de drenaje 7 puntos
- ⑯ Cuerpo acelerador mecánico

- ⑰ Cuerpo acelerador digital
- ⑱ Motor control de emisiones
- ⑲ Sistema drenaje manual
- ⑳ Sistema drenaje aire actuado
- ㉑ Diseño antiguo
- ㉒ Diseño nuevo
- ㉓ 160 grados
- ㉔ Para acero inoxidable use versión 18-1989

APLICACIÓN TERMOSTATO (Cont.)

Motor / Modelo	CID / # CIL	Intervalo años	Desde Nº Serie #	Hasta Nº Serie #	Alojamiento	Termostato Tapa	Termostato & kit juntas	Termostato	Requiere Juntas	Requiere juntas - Diseño II	Juntas Requiere - Desieño III
170	224/L4	1985-1986	6916779	B434940	18-3667		18-3667	18-3555	18-2555		
175/4.3L, 4.3LX (262 CID)	③		B527955	SUP	—		18-3668	18-3551	18-2553	18-2554	
175/4.3L, 4.3 LX (262 CID)	④		B527955	SUP	—		18-3668	18-3551	18-2552	18-7173	
175/4.3L, 4.3 LX (262 CID)	④		F001220	SUP	—		18-3648	18-3649	18-2552	18-7173	
180/3.7L-LX (4 CIL)			6916779	SUP	—		18-3667	18-3555	18-2555		
180	224/L4	1987	B436391	B775248			18-3667	18-3555	18-2555		
185 (229 CID)			6330183	6919655	18-1994	♥	18-3668	18-3551	18-2553	18-2554	
185 (262 CID)			A331455	B527954	18-1994	♥	18-3668	18-3551	18-2553	18-2554	
190			1564539	1730903	—		—	—	—	—	
190	224/L4	1985-1986	6916779	B436390			18-3667	18-3555	18-2555		
3.7L	224/L4	1988-1989	B774552	& SUP			18-3667	18-3555	18-2555		
3.7LX	224/L4	1988-1989	B775249	& SUP			18-3667	18-3555	18-2555		
470 MCM/MIE	224/L4	1976-1982	4208730	6218036			—	—	—	—	
470	224/L4	1983-1984	6218037	6916778			18-3667	18-3555	18-2555		
485	224/L4	1980-1982	5685394	6218036			—	—	—	—	
488	224/L4	1983-1984	6170297	6916778			18-3667	18-3555	18-2555		
140 (6 CIL)	194/L6	1963	1538930	1725960			—	—	—	—	
150	230/L6	1964-1966	1666495	2048046	④		—	—	—	—	
150	230/L6	1964-1966	1727985	2048046	⑤		—	—	—	—	
160	250/L6	1967-1969	2048022	2770031	④		—	—	—	—	
160	250/L6	1967	2048022	2233574	⑤		—	—	—	—	
160	250/L6	1968-1969	2326096	2770031	18-1910	②, ③	—	—	—	—	
165 (6 CIL)	250/L6	1970-1981	2770032	5813433	18-1910	③	18-3650	18-3550	18-2831		
200 (6 CIL)	292/L6	1969	2453769	2712072	18-1910	③	—	—	—	—	
185 (4bb)	229-V-6	1983-1984	6330183	6919655	18-3678		18-3668	18-3551	18-2554	18-2553	18-2917
175	262/V-6	1987	B527955	B773242	18-1994	①	18-1977-1	18-3668	18-3551	18-2554	18-2917
175	262/V-6	1987	B527955	B773242	18-1994	②, ③	—	—	—	—	
185 (2bb)	262/V-6	1985-1986	A331455	B527954	18-1994	①	18-1977-1	18-3668	18-3551	18-2554	18-2917
205	262/V-6	1985-1986	A331455	B527954	18-3668	①	18-1977-1	18-3668	18-3551	18-2554	18-2917
205	262/V-6	1987	B527955	B775129	18-3668	①	18-1977-1	18-3668	18-3551	18-2554	18-2917
205	262/V-6	1967	B527955	B775129	—	②, ③	—	—	—	—	
205/4.3L, 4.3 LX (262 CID)	④		B527955	D714369	—	④	—	—	—	—	
205/4.3L, 4.3 LX (262 CID)	④		F001220	SUP	—	④	18-3648	18-3649	18-2552	18-7173	
215 FORD			2781153	3040410	—		—	—	—	—	
215 FORD			3040411	SUP	—		18-3651	18-3551	18-2834	—	
215 FORD MCM/MIE			3040411	3385720	—		18-3646	18-3649	18-2834	—	
225 FORD MCM/MIE			3385721	4176999	—		18-3646	18-3649	18-2834	—	
262 MAG EFI ALPHA	262/V-6	1996-1997	0F803800	0K999999	18-3647		18-3647	18-3649	18-2917		
262 MAG EFI BRAVO	262/V-6	1996-1997	0F803800	0K999999	18-3647		18-3647	18-3649	18-2917		
4.3L	262/V-6	1988-1993	B773243	F000877	18-1994	①	18-1977-1	18-3668	18-3551	18-2554	18-2917
4.3L	262/V-6	1987-1993	B773243	F000877	—	②, ③	—	—	—	—	
4.3L	262/V-6	1993-1995	F000878	F601126	18-3647	②, ④	—	—	—	—	
4.3L	262/V-6	1993-1995	F000878	F601126	—	⑤	—	—	—	—	
4.3L FWC	262/V-6	1993-2002	F000878	M614999	18-3531	⑥	—	—	—	—	
4.3L ALPHA	262/V-6	1996-2002	0F601127	M614999	18-3647	⑦	—	—	—	—	
4.3L BRAVO	262/V-6	1996-2002	0F601127	M614999	18-3647	⑦	—	—	—	—	
4.3L FWC	262/V-6	2002-2010	M615000	& SUP	—	⑧	—	—	—	—	
4.3L	262/V-6	2002-2010	M615000	& SUP	—	⑨	18-3647	18-3649	18-0398		
4.3L EFI FWC	262/V-6	1998-2001	L012009	M299999	18-3531	⑩	—	—	—	—	
4.3L EFI ALPHA	262/V-6	1998-2001	L012009	M299999	—	⑪	18-3647	18-3649	18-0398		
4.3L EFI BRAVO	262/V-6	1998-2001	L012009	M299999	18-3530-1	⑫	—	—	—	—	
4.3L MPI	262/V-6	2002-2010	M300000	& SUP	—	⑬, ⑭	—	—	—	—	
4.3L MPI	262/V-6	2002-2010	M300000	& SUP	—	⑮, ⑯	—	—	—	—	
4.3L MPI EC	262/V-6	2010-2011	A637496	& SUP	—	⑰, ⑱	—	—	—	—	
4.3L MPI FWC	262/V-6	2002	M300000	M614999	—	⑲	18-3568	18-3555	18-0398		
4.3L MPI FWC	262/V-6	2002-2010	M615000	& SUP	—	⑲	—	—	—	—	
4.3LH FWC	262/V-6	1998-2002	L010044	M614999	18-3531	⑲	18-3568	18-3555	18-0398		
4.3LH ALPHA	262/V-6	1998-2002	L010044	M614999	—	⑳	18-3647	18-3649	18-0398		
4.3LH BRAVO	262/V-6	1998-2002	L010044	M614999	18-3530-1	㉑	—	—	—	—	
4.3LX	262/V-6	1988-1993	B775130	F001219	18-1994	①	18-1977-1	18-3668	18-3551	18-2554	18-2553
4.3LX	262/V-6	1988-1993	B775130	F001219	—	②, ③	—	—	—	—	
4.3LX	262/V-6	1993-1995	F001220	F601126	—	④, ⑤	—	—	—	—	
43LX	262/V-6	1993-1995	F001220	F601126	—	⑥	—	—	—	—	
4.3LX FWC	262/V-6	1993-1997	F001220	K999999	—	⑦	—	—	—	—	
4.3LX ALPHA	262/V-6	1996-1997	F601127	K999999	—	⑧	18-3647	18-3649	18-0398		
4.3LX BRAVO	262/V-6	1996-1997	F601127	K999999	18-3530-1	⑨	—	—	—	—	
4.3LXH FWC	262/V-6	1996-1997	F803114	K999999	—	⑩	18-3568	18-3555	18-0398		
4.3LXH ALPHA	262/V-6	1996-1997	F803114	K999999	18-3530-1	⑪	—	—	—	—	
4.3LXH BRAVO	262/V-6	1996-1997	F803114	K999999	18-3530-1	⑫	—	—	—	—	
215 MCM/MIE (FORD)	302/V-8	1970	2781153	3040410	—		—	—	—	—	
215 MCM/MIE (FORD)	302/V-8	1971-1972	3040411	3385720	—		18-3646	18-3551	18-2834		
225 MCM/MIE (FORD)	302/V-8	1973-1974	3385721	4176999	—		18-3646	18-3551	18-2834		
888 (FORD)	302/V-8	1971-1977	3108723	4887829	—	⑬	18-3646	18-3551	18-2834		
190	283/V-8	1963-1964	1564539	1730903	—		—	—	—	—	
198 MIE	305/V-8	1977	4776402	4931099	—		18-1977-1	18-3646	18-3551	18-2844	18-0398
200	305/V-8	1985-1987	6899058	B774444	18-1994		18-1977-1	18-3668	18-3551	18-2554	18-2553
200 GM			6218462	B525981	18-1994	♥	—	—	—	—	
200/5.0L			0B525982	0F600999	—		18-3647	18-3649	18-2917	—	
200/5.0L GM	③		B525982	SUP	18-1994	♥	—	—	—	—	
200/5.0L GM	④		B525982	SUP	18-1994	♥	—	—	—	—	
228	305/V-8	1977-1982	4765100	6218461	—		18-1977-1	18-3646	18-3551	18-2844	18-0398
228	305/V-8	1982-1984	6218462	6899268	18-1994		18-1977-1	18-3668	18-3551	18-2554	18-2553
228 MIE	305/V-8	1977-1980	4765100	5907057	18-3651		18-1977-1	18-3646	18-3551	18-2844	18-1993
230	305/V-8	1985-1987	6899269	B773739	18-1994		18-1977-1	18-3668	18-3551	18-2554	18-2553
230 MIE	305/V-8	1981-1987	5907058	B788151	18-1994	①	18-1977-1	18-3668	18-3551	18-2554	18-2553
230 MIE FWC	305/V-8	1981-1987	5907058	B788151	—	②	18-1977-1	18-3646	18-3551	18-2553	18-2844
230 GM			6218462	B525981	18-1994	♥	—	—	—	—	
230 MIE			5907058	0B5225505	—		—	—	—	—	
230 GM IB	⑤		5907058	B522505	—	③	—	—	—	—	
230 GM IB	⑥		5907058	B522505	—	④	—	—	—	—	
230/5.0L GM IB	③, ⑤		B522506	B525981	—	⑤, ⑦	—	—	—	—	
230/5.0L GM IB	④, ⑤		B522506	B525981	—	⑥, ⑧	—	—	—	—	
230/5.0L GM IB	⑥		B522506	B525981	—	⑨	—	—	—	—	
230/5.0L-LX GM	③		B525982	F600999	18-1994	♥	—	—	—	—	
230/5.0L-LX GM	④		B525982	SUP	—		—	—	—	—	
230/5.0L GM IB	④		B522506	B525981	—		18-3648	18-3649	18-2552	18-7173	
230/5.0L-LX GM			B525982	F600999	18-1994	♥	—	—	—	—	
230/5.0L MIE			0B522506	0B788151	—		18-3646	18-3649	18-2552	18-7173	
230/5.0LX GM			0B525982	0F600999	—		18-3646	18-3649	18-2553	18-2844	18-2917
5.0L	305/V-8	1988-1995	B774445	F600999	18-1994	①	18-1977-1	18-3668	18-3551	18-2554	18-2553
5.0L	305/V-8	1988-1995	B774445	F600999	—	②, ③	—	—	—	—	

- ① Diseño I
- ② Diseño II
- ③ Diseño III
- ④ Aluminio escape Manifold
- ⑤ Colector escape Manifold
- ⑥ Refrigeración cerrado
- ⑦ Refrigeración estándar
- ⑧ Con bola retención
- ⑨ Sin bola retención
- ⑩ SN 4167000 & Sup
- ⑪ Termostato aloj. Original aparece como la NLA Kit actualización 87290A23
- ⑫ Termostato aloj. Original aparece como la NLA Kit actualización 90736A24
- ⑬ Termostato alojamiento kit completo
- ⑭ Solo 3 puntos y sistema de drenaje
- ⑮ Sistema de drenaje 7 puntos
- ⑯ Cuerpo acelerador mecánico
- ⑰ Cuerpo acelerador digital
- ⑱ Motor control de emisiones
- ⑲ Sistema drenaje manual
- ⑳ Sistema drenaje aire actuado
- ㉑ Diseño antiguo
- ㉒ Diseño nuevo
- ♣ 160 grados
- ♥ Para acero inoxidable use versión 18-1989

APLICACIÓN TERMOSTATO (Cont.)

Table with columns: Motor / Modelo, CID / # CIL, Intervalo Año, Desde Nº serie #, Hasta Nº Serie #, Alojamiento, Termostato Tapa, Termostato & kit juntas, Termostato, Requiere Juntas, Juntas Requiere - Diseño II, Junta Requiere - Diseño III. Rows include various GM and Ford engine models and their corresponding thermostat specifications.

- ① Diseño I
② Diseño II
③ Diseño III
④ Aluminio escape Manifold
⑤ Colector escape Manifold
⑥ Refrigeración cerrado
⑦ Refrigeración estándar
⑧ Con bola retención
⑨ Sin bola retención
⑩ SN 4167000 & Sup
⑪ Termostato aloj. Original aparece como la NLA Kit actualización 87290A23
⑫ Termostato aloj. Original aparece como la NLA Kit actualización 90736A24
⑬ Termostato alojamiento kit completo
⑭ Solo 3 puntos y sistema de drenaje
⑮ Sistema de drenaje 7 puntos
⑯ Cuerpo acelerador mecánico
⑰ Cuerpo acelerador digital
⑱ Motor control de emisiones
⑲ Sistema drenaje manual
⑳ Sistema drenaje aire actuado
㉑ Diseño antiguo
㉒ Diseño nuevo
㉓ 160 grados
㉔ Para acero inoxidable use versión 18-1989

APLICACIÓN TERMOSTATO (Cont.)

Motor / Modelo	CID / # CIL	Intervalo años	Desde Nº serie #	Hasta Nº serie #	Alojamiento	Tapa Termostato	Termostato & kit junta	Termostato	Requiere junta	Junta Requiere - Diseño II	Junta Requiere - Diseño III
350 MAG MPI MIE	350/V-8	2002-2007	M300000	A089999	⑦		18-3647	18-3649	18-0398		
350 MAG MPI SKI	350/V-8	1995-2001	F350583	M299999	18-3530-1		18-3647	18-3649	18-0398		
350 MAG MPI SKI	350/V-8	2002-2007	M300000	A089999			18-3647	18-3649	18-0398		
350 MAG SKI	350/V-8	1991-1996	D505450	K040399	②, ③		18-3668	18-3551	18-7173	18-2552	18-2917
350 MAG SKI	350/V-8	1991-1997	D505450	K999999	18-3530-1 ③		18-3647	18-3649	18-0398		
5.7L	350/V-8	1988-1995	B773305	F600999	18-1994 ①	18-1977-1	18-3668	18-3551	18-2554	18-2553	18-2917
5.7L	350/V-8	1988-1995	B773305	F600999	②, ③		18-3668	18-3551	18-7173	18-2552	18-2917
5.7L	350/V-8	1988-1995	B773305	F600999	③, ④		18-3668	18-3551	18-7173	18-2552	18-2917
5.7L	350/V-8	1988-1996	B773305	K001526	③		18-3647	18-3649	18-2844	18-0398	
5.7L FWC	350/V-8	1997	K001527	K999999	18-3531 ②		18-3568	18-3555	18-1508		
5.7L ALPHA	350/V-8	1988-1997	B773305	F600999	⑦		18-3647	18-3649	18-0398		
5.7L BRAVO	350/V-8	1995-1997	F601000	K999999	18-3530-1 ⑦		18-3647	18-3649	18-0398		
5.7L (GEN+) FWC	350/V-8	1998-2002	L010037	M599999	18-3531 ②		18-3568	18-3555	18-1508		
5.7L (GEN+) ALPHA	350/V-8	1998-2002	L010037	M599999	⑦		18-3647	18-3649	18-0398		
5.7L (GEN+) BRAVO	350/V-8	1998-2002	L010037	M599999	18-3530-1 ⑦		18-3647	18-3649	18-0398		
5.7L (GEN+) FWC	350/V-8	2002-2010	M600000	& SUP	②				18-0398		
5.7L (GEN+) FWC	350/V-8	2002-2010	M600000	& SUP	⑦		18-3647	18-3649	18-0398		
5.7L EFI FWC	350/V-8	1995-1996	F225560	K001505	②		18-3647	18-3649	18-2844	18-0398	
5.7L EFI FWC	350/V-8	1997-2001	K001506	M299999	18-3531 ②		18-3568	18-3555	18-1508		
5.7L EFI ALPHA	350/V-8	1995-2001	F355305	M299999	⑦		18-3647	18-3649	18-0398		
5.7L EFI BRAVO	350/V-8	1995-2001	F225560	M299999	18-3530-1 ⑦		18-3647	18-3649	18-0398		
5.7L EFI MIE (GEN+) FWC	350/V-8	1997	K040300	K999999	18-3531 ②		18-3568	18-3555	18-1508		
5.7L EFI MIE (GEN+)	350/V-8	1997	K040300	K999999	18-3530-1 ⑦		18-3647	18-3649	18-0398		
5.7L MIE	350/V-8	1988-1995	B788152	F600999	18-1994 ①	18-1977-1	18-3668	18-3551	18-2554	18-2553	18-2917
5.7L MIE	350/V-8	1988-1995	B788152	F622099	②, ③		18-3668	18-3551	18-7173	18-2917	
5.7L MIE	350/V-8	1988-1995	B788152	F622099	②, ④		18-3668	18-3555	18-7173	18-2917	
5.7L MIE FWC	350/V-8	1988-1996	B788152	K04306	②		18-3647	18-3649	18-2844		
5.7L MIE FWC	350/V-8	1997-2002	K040307	M316999	18-3531 ②		18-3568	18-3555	18-1508		
5.7L MIE	350/V-8	1996-2002	F622100	M316999	⑦		18-3647	18-3649	18-0398		
5.7L MIE FWC	350/V-8	2002-2010	M317000	& SUP	②				18-0398		
5.7L MIE	350/V-8	2002-2010	M317000	& SUP	⑦		18-3647	18-3649	18-0398		
5.7L MPI HORIZON MIE	350/V-8	2008-2010	A0900000	& SUP	②				18-0398		
5.7L MPI MIE FWC	350/V-8	2008-2010	A0900000	& SUP	②				18-0398		
5.7L MPI MIE FWC DTS	350/V-8	2008-2010	A0900000	& SUP	②, ⑦				18-0398		
5.7L MPI MIE FWC EC	350/V-8	2008-2010	A0900000	& SUP	②, ⑥, ⑥				18-0398		
5.7L MPI MIE FWC EC DTS	350/V-8	2008-2010	A0900000	& SUP	②, ⑦, ⑥				18-0398		
5.7L MPI MIE	350/V-8	2008-2010	A0900000	& SUP	⑦		18-3647	18-3649	18-0398		
5.7L MPI MIE EC	350/V-8	2008-2010	A0900000	& SUP	②, ⑧		18-3647	18-3649	18-0398		
5.7L MPI SKI	350/V-8	2008-2010	A0900000	& SUP	②		18-3647	18-3649	18-0398		
5.7L MPI SKI EC	350/V-8	2008-2010	A0900000	& SUP	⑧		18-3647	18-3649	18-0398		
5.7L SKI	350/V-8	1985-1995	A338553	F775199	18-1994 ①	18-1977-1	18-3668	18-3551	18-2554	18-2553	18-0398
5.7L SKI	350/V-8	1987-1995	B514627	F775199	②, ③		18-3668	18-3551	18-7173	18-0398	
5.7L SKI	350/V-8	1987-1995	B514627	F775199	②, ④		18-3668	18-3551	18-7173	18-0398	
5.7L SKI	350/V-8	1996-2002	F775200	M316999	18-3530-1 ③		18-3647	18-3649	18-0398		
5.7L SKI	350/V-8	2002-2010	M317000	& SUP	⑦		18-3647	18-3649	18-0398		
5.7LX ALPHA	350/V-8	1995-1997	F601000	K999999	⑦		18-3647	18-3649	18-0398		
5.7LX BRAVO	350/V-8	1995-1997	F601000	K999999	18-3530-1 ⑦		18-3647	18-3649	18-0398		
5.7LX RWC	350/V-8	1996	F601000	K001526	②		18-3647	18-3649	18-2844	18-0398	
5.7LX RWC	350/V-8	1997	K001527	K999999	18-3531 ②		18-3568	18-3555	18-1508		
5.7LX BRAVO EFI (GEN+) FWC	350/V-8	1996	F800300	K001508	②		18-3647	18-3649	18-2844	18-0398	
5.7LX BRAVO EFI (GEN+) FWC	350/V-8	1997	K001509	K999999	②		18-3568	18-3555	18-0398		
5.7LX BRAVO EFI (GEN+)	350/V-8	1996-1997	F800300	K999999	18-3530-1 ②		18-3647	18-3649	18-0398		
5.7LX EFI FWC	350/V-8	1996	F752400	K001505	②		18-3647	18-3649	18-2844	18-0398	
5.7LX EFI FWC	350/V-8	1997	K001506	K999999	18-3531 ②		18-3568	18-3555	18-0398		
5.7LX EFI ALPHA	350/V-8	1996-1997	F752400	K999999	⑦		18-3647	18-3649	18-0398		
5.7LX EFI BRAVO	350/V-8	1996-1997	F752400	K999999	18-3530-1 ⑦		18-3647	18-3649	18-0398		
5.7 GM ALPHA			F225560	0K999999			18-3647	18-3649	18-2917	—	
5.7 GM BRAVO			F225560	0K999999			18-3647	18-3649	18-2917	—	
5.7L/EFI GM ALPHA			L010037	SUP			18-3647	18-3649	18-2917	—	
5.7L/EFI GM BRAVO			L010037	sUP			18-3647	18-3649	18-2917	—	
5.7L MIE			F025000	0F622099			18-3647	18-3649	18-2844	—	
5.7L MIE			F622100	0K999999			18-3647	18-3649	18-2917	—	
5.7L MIE			F622100	0K999999			18-3647	18-3649	18-2844	—	
5.7L MIE			L002003	SUP			18-3647	18-3649	18-2917	—	
BLACK SCORPION SKI	350/V-8	1996-2001	0F800000	M391599	18-3530-1		18-3647	18-3649	18-0398		
BLACK SCORPION SKI	350/V-8	2003-2006	M391600	W690192	②		18-3647	18-3649	18-0398		
BLACK SCORPION SKI	350/V-8	2006-2007	W690193	W698432	②		18-3647	18-3649	18-0398		
BLACK SCORPION SKI	350/V-8	2003-2007	M391600	W698433	⑩		18-3647	18-3649	18-0398		
SCORPION 350	350/V-8	2008-2010	W698433	& SUP	②		18-3647	18-3649	18-0398		
SCORPION 350	350/V-8	2008-2010	W698433	& SUP	⑩		18-3647	18-3649	18-0398		
SCORPION 350 EC	350/V-8	2008-2010	W698433	& SUP	②		18-3647	18-3649	18-0398		
233 MCM (FORD)	351/V-8	1975-1977	4173000	4902304			18-3646	18-3551	18-2834		
233 MIE (FORD)	351/V-8	1975-1977	4173000	4902304			18-3646	18-3551	18-2834		
255 MCM/MIE (FORD)	351/V-8	1973-1974	3258728	4178299			18-3646	18-3551	18-2834		
377 MAG FWC	377/V-8	2008-2010	A300000	& SUP	②, ⑥				18-0398		
377 MAG FWC DTS	377/V-8	2008-2010	A300000	& SUP	②, ⑦				18-0398		
377 MAG FWC EC	377/V-8	2008-2010	A300000	& SUP	②, ⑧				18-0398		
377 MAG FWC EC DTS	377/V-8	2008-2010	A300000	& SUP	②, ⑦, ⑥				18-0398		
377 MAG	377/V-8	2008-2010	A300000	& SUP	②, ④		18-3647	18-3649	18-0398		
377 MAG	377/V-8	2008-2010	A300000	& SUP	②, ⑤		18-3647	18-3649	18-0398		
377 MAG EC	377/V-8	2008-2010	A300000	& SUP	②, ⑧		18-3647	18-3649	18-0398		
377 SCORPION MCM	377/V-8	1999-2005	L416146	M907201		18-1977-1			18-0398		
377 SCORPION SKI	377/V-8	1997-1998	K000656	L600314			18-3647	18-3551	18-0398		18-2553
MX 6.2L MPI FWC	377/V-8	2000-2001	L680003	M299999	18-3531 ②		18-3568	18-3555	18-0398		
MX 6.2L MPI	377/V-8	2000-2001	L680003	M299999	18-3530-1 ⑦		18-3647	18-3649	18-0398		
MX 6.2L MPI FWC	377/V-8	2002	M300000	M599999	②		18-3568	18-3555	18-0398		
MX 6.2L MPI FWC	377/V-8	2002-2007	M600000	A299999	②				18-0398		
MX 6.2L MPI	377/V-8	2002-2007	M300000	A299999	②, ④		18-3647	18-3649	18-0398		
MX 6.2L MPI	377/V-8	2002-2007	M300000	A299999	②, ⑤		18-3647	18-3649	18-0398		
MX 6.2L MPI HORIZON	377/V-8	2002	M300000	M599999	②		18-3568	18-3555	18-0398		
MX 6.2L MPI HORIZON	377/V-8	2002-2007	M600000	A299999	②				18-0398		
MX 6.2L MPI HORIZON MIE	377/V-8	2002	M300000	M316999	②		18-3568	18-3555	18-0398		
MX 6.2L MPI HORIZON MIE	377/V-8	2002-2010	M317000	& SUP	②				18-0398		
MX 6.2L MPI MIE FWC	377/V-8	1999-2002	L670000	M316999	②		18-3568	18-3555	18-0398		
MX 6.2L MPI MIE FWC	377/V-8	2002-2010	M317000	& SUP	②, ⑥				18-0398		
MX 6.2L MPI MIE FWC DTS	377/V-8	2008-2010	A0900000	& SUP	②, ⑦				18-0398		
MX 6.2L MPI MIE FWC EC	377/V-8	2008-2010	A0900000	& SUP	②, ⑥, ⑥				18-0398		
MX 6.2L MPI MIE FWC EC DTS	377/V-8	2008-2010	A0900000	& SUP	②, ⑦, ⑥				18-0398		
MX 6.2L MPI MIE	377/V-8	2002-2010	M300000	& SUP	⑦		18-3647	18-3649	18-0398		
MX 6.2L MPI MIE	377/V-8	2008-2010	A0900000	& SUP	⑦		18-3647	18-3649	18-0398		
MX 6.2L BLACK SCORPION	377/V-8	2001-2002	L005601	M391599	18-3530-1		18-3647	18-3649	18-0398		

APLICACIÓN TERMOSTATO(Cont.)

Motores / Modelos	CID / # CIL	Intervalo Año	Desde Serial #	Hasta Nº Serie #	Alojamiento	Tapa termostato	Termostato & Kit junta	Termostato	Requiere junta	Requiere juntas - Diseño II	Requiere Juntas - Diseño III
MX 6.2L BLACK SCORPION	377V-8	2003-2006	M391600	W690192	⑩		18-3647	18-3649	18-0398		
MX 6.2L BLACK SCORPION	377V-8	2006-2007	W690192	W698432	⑩		18-3647	18-3649	18-0398		
SCORPION 377	377V-8	2008-2010	W698433	& SUP	⑩		18-3647	18-3649	18-0398		
SCORPION 377	377V-8	2008-2010	W698433	& SUP	⑩		18-3647	18-3649	18-0398		
SCORPION 377 HO EC	377V-8	2008-2010	A091488	A092170	⑩		18-3647	18-3649	18-0398		
325 MCM/MIE	427V-8	1969-1972	2278747	3780449			18-3646	18-3551	18-2553		18-0398
330 (WITH MERC TRANS)	454V-8	1977-1981	4623115	6083144			18-3646	18-3551	18-2844	18-0398	
330 (WITH B/W) FWC	454V-8	1982-1987	6083145	B816540	⑩		18-3646	18-3551	18-2553		18-0398
330 (WITH B/W)	454V-8	1982-1987	6083145	B816540	18-3678	⑦	18-3668	18-3551	18-2554	18-2553	18-0398
330 MIE (WITH MERC TRANS)	454V-8	1977-1980	4623115	5889913			18-3646	18-3551	18-2844		18-0398
340 MIE FWC	454V-8	1981-1987	5889914	B788365	⑩		18-3646	18-3551	18-2553	18-2844	18-0398
340 MIE	454V-8	1981-1987	5889914	B788365	18-3678	⑦	18-3668	18-3551	18-2554	18-2844	18-0398
340 MIE	454V-8	1981-1987	5889914	B788365		⑦, ⑩	18-3668	18-3551	18-2554	18-2553	18-0398
340/7.4L MIE			5889914	0D715493			18-3646	18-3649	18-2553	18-2844	18-2917
350 MIE	454V-8	1974-1976	3780450	4623109			18-3646	18-3551	18-2844	18-0398	
350 GM (MAGNUM)			A635178	B525981			18-3668	18-3551	18-2553	18-2554	
350 GM (MAGNUM)	③		B525982	SUP		⑧	18-3668	18-3551	18-2553	18-2554	
350 GM (MAGNUM)	④		B525982	SUP		⑧	18-3668	18-3551	18-2552	18-7173	
350 GM (MAGNUM)	④		B525982	SUP	18-3648	⑧	18-3648	18-3649	18-2552	18-7173	
370	454V-8	1978-1985	4179554	6721527			18-3646	18-3551	18-2553	18-2844	18-0398
370	454V-8	1985-1987	6721528	B714586			18-3668	18-3551	18-2554	18-2553	18-0398
370 TRS GM			4179554	6721527			18-3651	18-3551	18-2553	18-2844	
370 TRS GM			6721528	SUP			18-3668	18-3551	18-2553	18-2554	
390 GM			2781129	2825059			18-3651	18-3551	18-2553	18-2844	
390 GM MCM/MIE			2781129	3042731			18-3646	18-3649	18-2553	18-2844	18-2917
400	454V-8	1980-1986	4179554	0B457644			18-3646	18-3551	18-2553	18-2554	18-0398
400 TRS GM			4179554	SUP			18-3651	18-3551	18-2553	18-2844	
420 GM			A398941	SUP	18-3651		18-3651	18-3551	18-2553	18-2844	
420	454V-8	1987-1989	A398941	B622418	18-1994		18-1977-1	18-3646	18-2553	18-2844	18-0398
425	454V-8	1990-1993	A398941	D937011	18-3678			18-3551	18-2553	18-2844	18-0398
440	454V-8	1983-1986	4179554	B485220			18-3646	18-3551	18-2553	18-2844	18-0398
450	454V-8	1995-1996	F347100	F347277	18-1994			18-3551	18-2553	18-2844	18-0398
525 SC	454V-8	1991-1999	D456000	L415623			18-1977-1	18-3551	18-2553	18-2844	18-0398
454 MAG ALPHA	454V-8	1986-1988	A631894	B785148	18-3678	①	18-3668	18-3551	18-2554	18-2553	18-0398
454 MAG ALPHA	454V-8	1986-1988	A631894	B785148		②, ③	18-3668	18-3551	18-7173	18-2552	18-0398
454 MAG BRAVO	454V-8	1988-1992	B721206	D805068	18-3678	①	18-3668	18-3551	18-2554	18-2553	18-0398
454 MAG BRAVO	454V-8	1995-1997	F305000	K999999		②, ③	18-3647	18-3649	18-0398		
454 MAG BRAVO	454V-8	1988-1992	B721206	D805068		②, ③	18-3668	18-3551	18-7173		18-0398
454 MAG BRAVO	454V-8	1992-1994	D805069	F304999		②, ③	18-3668	18-3551	18-7173		18-0398
454 MAG EFI	454V-8	1995-1997	F115700	F802349		⑦	18-3647	18-3649	18-0398		
454 MAG EFI SKI	454V-8	1995-1997	F215800	K999999		⑦	18-3647	18-3649	18-0398		
454 MAG MPI	454V-8	1996-2001	F802350	M024999		⑦	18-3647	18-3649	18-0398		
454 MAG MPI FWC	454V-8	1998-2001	L010029	M024999	18-3531	⑥	18-3568	18-3555	18-0398		
454 MAG MPI HORIZON MIE	454V-8	1998-2001	L002200	L674000	18-3531	⑥	18-3568	18-3555	18-0398		
454 MAG MPI SKI	454V-8	1996-1997	F820100	K999999		⑦	18-3647	18-3649	18-0398		
525 SC	454V-8	1991-1999	D456000	L415623			18-1977-1	18-3551	18-2553	18-2844	18-0398
7.4L BRAVO	454V-8	1995-1997	0F352000	0K999999		⑦	18-3647	18-3649	18-0398		
7.4L BRAVO	454V-8	1988-1991	B771113	D603117	18-3678	①	18-3668	18-3551	18-2554	18-2553	18-0398
7.4L BRAVO	454V-8	1988-1991	B771113	D603117		②, ③	18-3668	18-3551	18-7173	18-2552	18-0398
7.4L BRAVO	454V-8	1992-1994	D603118	F351999		②, ③	18-3668	18-3551	18-7173	18-2552	18-0398
7.4L EFI MIE	454V-8	1996-1997	F874815	K999999		⑦	18-3647	18-3649	18-0398		
7.4L EFI MIE FWC	454V-8	1996-1997	F874815	K999999	18-3531	⑥	18-3568	18-3555	18-0398		
7.4L MIE FWC	454V-8	1988-1992	B788366	D715493		⑥	18-3646	18-3551	18-2553	18-2844	18-0398
7.4L MIE	454V-8	1988-1992	B788366	D715493		⑦, ⑧	18-3668	18-3551	18-2554	18-2553	18-0398
7.4L MIE	454V-8	1989-1994	C391564	D715493		⑦	18-3668	18-3551	18-7173	18-2552	18-0398
7.4L MIE FWC	454V-8	1989-1994	C391564	D715493		⑥	18-3646	18-3551	18-2553	18-2844	18-0398
7.4L MIE	454V-8	1989-1994	D715494	F349999		⑦	18-3668	18-3551	18-7173	18-2552	18-0398
7.4L MIE FWC	454V-8	1989-1994	D715494	F820141		⑥	18-3646	18-3649	18-2553	18-2844	18-0398
7.4L MIE	454V-8	1995-1996	F350000	F820141		⑦	18-3647	18-3649	18-0398		
7.4L MIE	454V-8	1996-1997	F820142	K999999		⑦	18-3647	18-3649	18-0398		
7.4L MIE	454V-8	1996-1997	F820142	K999999		⑥	18-3647	18-3649	18-2844	18-0398	
7.4L MPI	454V-8	1998-2001	L010003	M024330		⑦	18-3647	18-3649	18-0398		
7.4L MPI MIE	454V-8	1995-2001	F563052	M025999		⑦	18-3647	18-3649	18-0398		
7.4L MPI MIE FWC	454V-8	1995-2001	F563052	M025999		⑥	18-3568	18-3555	18-0398		
7.4LX BRAVO EFI	454V-8	1996-1997	F820000	K999999		⑦	18-3647	18-3649	18-0398		
7.4L BRAVO MPI	454V-8	1996-1997	F602010	K999999		⑦	18-3647	18-3649	18-0398		
7.4L MIE			0C391564	0D715493			18-3646	18-3649	18-2553	18-2844	18-2917
7.4L MIE			0C391564	0F349999			18-3646	18-3649	18-2553	18-2844	18-2917
390 MCM/MIE	482V-8	1969-1970	2781129	3042731			18-3646	18-3551	18-2553	18-2844	18-0398
460	482V-8	1983-1986	4179554	6181046			18-3668	18-3551	18-2554	18-2553	18-0398
465	502V-8	1990-1994	C849992	F213244	18-3678		18-3668	18-3551	18-2553	18-2844	18-0398
470			4208730	6218036			18-3652	18-3552	18-2843		
470			6218037	SUP			18-3667	18-3555	18-2555		
485			5685394	SUP			18-3652	18-3552	18-2555		
488			6170297	SUP			18-3667	18-3555	18-2555		
500	502V-8	1994-1998	F213293	L001772	18-1994		18-1977-1	18-3551	18-2553	18-2844	18-0398
500 (GEN +)	502V-8	1999	L414639	L601036	18-1994		18-1977-1	18-3551	18-2553	18-2844	18-0398
500 EFI	502V-8	1999-2005	L001477	M907127			18-1977-1	18-3551	18-2553	18-2844	18-0398
502 MAG	502V-8	1990-1993	C878221	F114528		⑧	18-3668	18-3551	18-7173	18-2552	18-0398
502 MAG EFI	502V-8	1993-1995	D840650	F802599		⑦	18-3647	18-3649	18-0398		
502 MAG MPI	502V-8	1996-1997	F802600	K999999		⑦	18-3647	18-3649	18-0398		
502 MAG MPI FWC	502V-8	1998-2001	L017000	M024999	18-3531	⑥	18-3568	18-3555	18-0398		
525 EFI	502V-8	2003-2010	M900146	& SUP			N/A		18-1508		
575 GM			0A677429	0D763716			18-3646	18-3649	18-2553	18-2844	18-2914
575			A677429	SUP			18-3651	18-3551	18-2553	18-2844	
8.2L MAG	502V-8	2010	A350340	& SUP					18-1508		
8.2L MIE EC	502V-8	2010	A350802	& SUP					18-1508		
8.2L MIE	502V-8	1990-1992	C878221	D857199		⑧	18-3668	18-3551	18-7173	18-2552	18-0398
8.2L MIE FWC	502V-8	1990-1992	C878221	D857199							



18-7702
SENSOR DE TEMPERATURA
Reemplaza: 805223T
Para: Mercruiser V6 & V8(350, 454, 496 & 502 cid) Motores MPI



18-5897
SENSOR
Reemplaza: 97257A1, 806490T, 97257, 806490, 811091, 36525
Para temperatura agua
3/8" - 18 NPT



18-5898
SENSOR
Reemplaza: 97258A1, 97258, 34625, FI6900198, FI6900152
Para temperatura agua
1/2" -14 NPT



18-5899
SENSOR PRESIÓN DE ACEITE
Reemp: 90806, 815425T, 90806A1, 815425, 34623, 8M0068784
Para presión de aceite

APLICACIÓN SENSOR TEMPERATURA/SENSOR PRESIÓN ACEITE

Modelo	Serie #	Presión Aceite	Temperatura Agua	Modelo	Serie #	Presión Aceite	Temperatura Agua
ROVER	31400000F & SUP	—	18-5897	270	2851074-3077735	18-5899	18-5897
110	1565944-1566081	18-5899	18-5898	280	4176250 & SUP	18-5899	18-5898
110	1602980 & SUP	18-5899	18-5898	300 MR/TRS	6668677 & SUP	18-5899 ②	18-5897 ②
120	2324346 & INF	18-5899	18-5898	320	A543604 & SUP	18-5899 ②	18-5897 ②
120	2324347 & SUP	18-5899 ① ②	18-5897 ②	325	2278747 & SUP	18-5899	18-5897 ⑧ ⑨
140 (4 cil/3.0)	2508061 - 3462607	18-5899 ②	18-5897 ②	330	4623115 & SUP	18-5899	18-5898
140 (4cil/3.0)	4512156 & SUP	18-5899 ②	18-5897 ②	330/W.B.W.	6083145 & SUP	18-5899 ②	18-5897 ②
3.0L/3.0LX	C856559 & SUP	18-5899 ②	18-5897 ②	340/7.4L	5889914 & SUP	18-5899 ②	18-5897 ②
140 (6 cil)	1566119-1725960	18-5899	18-5898	350	3780450 & SUP	18-5899	18-5898
150	1666495-2048046	18-5899	18-5898	350 (Magnum)	A635178- B525981	18-5899 ②	18-5897 ②
160	2048022-2770031	18-5899	18-5897 ④ ⑤	350 (Magnum)	B525982-0505449	—	18-5897 ② ⑥ ⑦
165	2770032 & SUP	18-5899	18-5897	350 (Magnum)	D505450 & SUP	18-5899 ②	18-5897 ②
165/3.7L/170/180	6916779 & SUP	18-5899	—	370 (TRS)	4179554 & SUP	18-5899 ②	18-5897 ②
175 (262 CID)	B527955 & SUP	18-5899 ②	18-5897 ② ⑥ ⑦	390	2781129-2825059	18-5899	18-5897
4.3L (Generation II)	D714107 & SUP	18-5899 ②	18-5897 ②	400	4179554 & SUP	18-5899	18-5897
185 (229 CID)	6330183 & SUP	18-5899 ②	18-5897 ②	420/425	A398941 & SUP	18-5899 ②	18-5897 ②
185 (262 CID)	A331455 & SUP	18-5899 ②	18-5897 ②	440	4179554 & SUP	18-5899	18-5897
190	1504311-1730903	18-5899	18-5898	454 (Magnum)	A631894 & SUP	18-5899 ②	18-5897 ②
190 (4 cil)	6916779 & SUP	18-5899	—	454 (Bravo)	B721206-D805068	18-5899 ②	18-5897 ② ⑥ ⑦
200	2453769-271202	18-5899	18-5897	460	4179554	18-5899	18-5897
200	6218462 & SUP	18-5899 ②	18-5897 ②	465	C849992 & SUP	18-5899 ②	18-5897 ②
200/5.0	B525982 & SUP	—	18-5897 ② ⑥ ⑦	500	C577254 & SUP	18-5899 ②	18-5897 ②
205 (262 CID)	A331455 & SUP	18-5899 ②	18-5897 ②	502 (Bravo)	C878221 & SUP	18-5899 ②	18-5897 ②
205 (4.3L)	B527955 & SUP	18-5899 ②	18-5897 ② ⑥ ⑦	502 (Bravo Gen V)	D824589 & SUP	—	18-5897
4.3LX (Generation II)	D714370 & SUP	18-5899 ②	18-5897 ②	525	D456000 & SUP	18-5899 ②	18-5897 ②
215	2781153 & SUP	18-5899	18-5897	575	A677429 & SUP	18-5899 ②	18-5899 ②
225 (Ford)	3385721 & SUP	18-5899	18-5897	888	3108723 & SUP	18-5899	18-5897
225 (GM)	1632308-2694014	18-5899	18-5897 ⑧ ⑨	898	4762210-6218461	18-5899	18-5898
228	4765100-6218461	18-5899	18-5898	898	6218462 & SUP	18-5899 ②	18-5897 ②
228 & 230	6218462 & SUP	18-5899 ②	18-5897 ②	5.7	A338553-B514626	18-5899 ②	18-5897 ②
230 (I.B.)	5907058 & SUP	18-5899 ②	18-5897 ②	5.7	B514627-B525981	18-5899 ②	18-5897 ② ⑥ ⑦
230 (5.0)	B522506 & SUP	18-5899 ⑩	18-5897 ⑥ ⑦	5.7 (Bravo)	B525982 & SUP	—	18-5897 ⑥ ⑦
233 Ford	4173000 & SUP	18-5899	18-5898	7.4 (Bravo)	B771113-D803117	18-5899 ②	18-5897 ② ⑥ ⑦
250	9314301-4908849	18-5899	18-5897 ⑧ ⑨	7.4 (Bravo Gen V)	D803118 & SUP	—	18-5897 ②
255	3258728 & SUP	18-5899	18-5898	7.4L (Hurth)	TODOS	18-5899 ②	18-5897 ②
260	4908850-6218461	18-5899	18-5898	454	D805069 & SUP	—	18-5897 ②
260	6218462 & SUP	18-5899 ②	18-5897 ②	8.2	C878221-D857199	18-5899 ②	18-5897 ②
260/5.7	B522506 & SUP	18-5899 ⑩	18-5897 ⑥ ⑦	8.2	D857200 & SUP	—	18-5897 ②
260	5907058 & SUP	18-5899 ②	18-5897 ②				

① S/N - 3377341-3461707 & 5192049 & SUP

② No incluye aplicación doble

④ 2326096 & SUP

⑤ 2233574 & INF use 18-5898

⑥ (3/8 - 18)

⑦ (1/2 -14) Use 18-5898

⑧ encendido eléctrico

⑨ encendido automático

⑩ Sólo N/S B525981



18-70948
MANGUITO

Reemplaza: 32-808033

Para: 262 Mag EFI Bravo con sistema refrigeración combustible (1996-97), 4.3L EFI (TBI) (1998-01), 5.0L (Gen+) Bravo (1998-07), 5.0L EFI (Gen+) (1998-01), 350 Mag Alpha (Gen+) (1997), 350 Mag Alpha EFI (Gen+) (1997), 350 Mag Bravo MPI (Gen+) (1997), 350 Mag MPI (Gen+) (1998-01), 5.7L (1997), 5.7L (Gen+) (1998-07), 5.7L EFI (1997), 5.7L EFI (Gen+) 1998-2001, 5.7LX (1997), 5.7LX Bravo EFI (Gen+) (1997), 5.7LX EFI (1997)

Para: Del enfriador al alojamiento termostato



18-70949
MANGUITO

Reemplaza: 32-807407

Para: 454 Mag MPI (Gen VI) (1996-01), 7.4LX MPI Bravo (Gen VI) (1996-97), 502 Mag MPI (Gen VI) (1996-01) Para: Del enfriador al alojamiento termostato



18-70954
MANGUITO

Reemplaza: 32-8600891, 32-860089

Para: 5.0L (Gen+) Bravo (1998-07), 5.0L EFI (Gen+) Alpha & Bravo (1998-01), 350 Mag Alpha (1997), 350 Mag EFI (Gen+) Alpha (1997), 350 Mag EFI (Gen+) Alpha (1997), 350 Mag MPI (Gen+) Bravo (1997-01), 350 Mag MPI (Gen+) Alpha (1998-01), 5.7L Alpha & Bravo (1997), 5.7L (Gen+) Alpha & Bravo (1998-07), 5.7L EFI Bravo (1997-01), 5.7LX Alpha & Bravo (1997), 5.7LX EFI (Gen+) Alpha & Bravo (1997), 6.2L MPI (2000-01) Para: Refrigerador aceite a refrigerador aceite.



18-70956
MANGUITO

Reemplaza: 32-16012

Para: MC175/205 (1987), 4.3L (1988-92), 4.3L (Gen II) (1992-95), 4.3LX (Gen II) (1992-95) Para: Para refrigerador aceite a alojamiento termostato con molde 4 conectores de manguito dentro del alojamiento termostato (Sin conector "T") Dos mangueras al colector y dos mangueras al codo.



18-70955
MANGUITO

Reemplaza: 32-16011

Para: MC200/230 (1987), 5.0L Alpha (1988-95), 5.0LX Alpha (1988-95), MC260 (1987), 350 Mag Alpha (1987-95), 5.7L Alpha & Bravo (1988-95), 454 Mag Bravo (1988-92), 7.4L (GenV) Bravo (1992-96)

Para: Refrigeración del aceite del termostato con los 4 conectores emitidos al termostato (No "T" connector) Dos mangueras al colector y dos mangueras al codo.



18-70952
MANGUITO

Reemplaza: 32-887952

Para: 5.0 L Bravo (1988-95), 5.0LX Bravo (1988-95), 350 Mag MPI Bravo (1995), 350 Mag MPI (Gen+) Bravo (1996), 5.7L Bravo (1988-96), 5.7L EFI 1995, 5.7L EFI Bravo (1996), 5.7LX EFI (Gen+) Bravo (1996) Para: De la bomba de agua marina del enfriador de aceite



18-70953
MANGUITO

Reemplaza: 32-8080441

Para: 5.0L EFI (Gen+) Bravo (1998-01), 350 Mag MPI (Gen+) (1998-01), 5.7L Bravo (1997), 5.7L (Gen+) Bravo (1998-07), 5.7L EFI Bravo 1997, 5.7L EFI (Gen+) Bravo (1998-01), 5.7LX Bravo (1997), 5.7LX EFI (Gen+) Bravo (1997), 6.2L MPI (2000-01) Para: De la bomba de agua marina al enfriador de aceite



18-70951
MANGUITO

Reemplaza: 32-860205, 32-807962, 32-807961

Para: 262 Mag. EFI Bravo (1996-97), 4.3L (Gen+) Bravo (1998-07), 4.3L TBI (Gen+) Bravo (1998-01), 4.3LH (Gen+) Bravo (1998-02), 4.3LX(H) (Gen+) Bravo (1996-97) Para: De la bomba de agua marina al enfriador de aceite



18-70945
MANGUITO

Reemplaza: 32-862139

Para: 4.3L (Gen+) (1998-07), 4.3L EFI (Gen+) (1998-01), 4.3LH (Gen+) (1998-02) Para: Termostato alojamiento a babor con colector de escape de 2 piezas



18-70947
MANGUITO

Reemplaza: 32-862124

Para: 4.3L (Gen+) (1998-07) (S/N 0L619000 & SUP), 4.3L EFI (Gen+) (2000-01), 4.3LH (Gen+) (2000-02) Para: termostato alojamiento a estribor con colector de escape de 2 piezas



18-70946
MANGUITO

Reemplaza: 32-8066362
Para: 262 Mag EFI (Gen+) (1996-97), 4.3L (Gen+) (1998-07) (S/N 0L01004-0L618999), 4.3L EFI (Gen+) (1998-00), 4.3LH (Gen+) 1998-00, 4.3LX (Gen+) (1996-97), 4.3LXH (Gen +) (1996-97)
Para: termostato alojamiento a estribor con colector de escape de 2 piezas



18-70950
MANGUITO

Reemplaza: 32-807661
Para: 3.0L (1999-07), 262 Mag EFI Alpha (1996-97), 4.3L (Gen+) Alpha (1998-07), 4.3L EFI (TBI Gen+) Alpha (1998-01), 4.3LH (Gen+) Alpha (1998-02), 4.3LX(H) (Gen+) Alpha (1996-97), 5.0L (Gen+) Alpha (1998-07), 5.0L EFI (Gen+) Alpha (1998-01), 350 Mag. Alpha (1997), 350 Mag. EFI (Gen+) Alpha (1997), 350 Mag. MPI (Gen+) Alpha (1998-01), 5.7L Alpha (1997), 5.7L (Gen+) Alpha (1998-07), 5.7L EFI Alpha (1997), 5.7L EFI (Gen+) Alpha (1998-01), 5.7LX Alpha (1997) Para: Del transom al enfriador de aceite



18-70957
MANGUITO

Reemplaza: 32-41642A3, 32-41642A1
Para: MC185 (1983-86), MC175 (1987), MC205 (1985-87), 4.3L (1988-92), 4.3L (Gen II) & 4.3LX (Gen II) (1992-95) Para: Del transom al enfriador de aceite



18-70958
MANGUITO

Reemplaza: 32-96246A4, 32-96246A1, 32-96246
Para: MC898 (1983-84), MC200 (1985-87), MC228 (1982-84), MC230 (1985-87), 5.0L & 5.0LX Alpha (1988-95), MC260 (1983-87), 300 Tempest MR (1985-86), MC320 EFI (1987-89), 350 MAG Alpha (1986-96), 5.7L Alpha (1988-96), 5.7LX & 5.7LX EFI Alpha (1996), 454 MAG Alpha (1986-88)
Para: Del transom al enfriador de aceite



18-70933
MANGUITO

Reemplaza: 32-861634, 32-89718, 32-46828, 32-16010
Para: 3.0L I/L 4 (1999 & Sup)



18-70934
MANGUITO

Reemplaza: 32-897181
Para: 330 (1977-87), 330 MIE (1977-80), 340 MIE W/ BW (1981-87), 370 TRS (1978-87), 400 TRS (1980-86), 420 (1987-89), 425 (1990-92), 425 (Gen V) (1992-93), 440 TRS (1983-86), 450 (Gen V) (1995-96), 454 EFI (Gen V) (1994-96), 454 Mag Alpha (1986-88), 454 Mag Bravo (1988-92), 454 Mag Bravo (Gen V) (1992-97), 454 Mag MPI Bravo (Gen VI) (1996-98), 454 Mag MPI SKI (Gen VI) (1996-97), 460 TRS (1983-86), 465 (1990-92), 465 (Gen V) (1992-94), 500 Gen + (1999), 500 (Gen V) (1994-96), 500 (Gen VI) (1997-98), 502 EFI (Gen V) (1993-95), 502 Mag Bravo (1990-92), 502 Mag MPI Bravo (Gen VI), 502 Mag Bravo (Gen V) (1992-93), 502 Mag MPI (Gen VI) (1996), 7.4L MIE W/BW (1988-92), 7.4L Bravo (1988-91), 7.4L Bravo (Gen V) (1992-96), 7.4L Bravo (Gen VI) (1996-97), 7.4L MIE (LH) (Gen V) (1992-96), 7.4L MIE (LH) (Gen VI) (1996-97), 7.4L MIE W/Hurth (1989-92), 7.4L MIE MPI (LH) (Gen VI) (1996-97), 7.4L TBI MIE (LH) (Gen VI) (1996-97), 7.4LX Bravo MPI (Gen V) (1996-97), 7.4LX Bravo TBI (Gen VI) (1996-97), 8.2L MIE (Gen V) (1993-96), 8.2L MIE MPI (Gen VI), 8.2



18-70935
MANGUITO

Reemplaza: 32-806856
Para: 200 2bbl (1987), 230 4bbl (1987), 260 (1987), 350 Mag SKI (1991-96), 350 Mag Alpha (1987-95), 350 Mag Alpha 4bbl (1996), 350 Mag Alpha EFI (Gen+) (1996), 350 Mag Bravo MPI (1995), 350 Mag Bravo MPI (Gen+) (1996), 350 Mag EFI SKI TBI (1994-96), 350 Mag MPI SKI (1995-96), 4.3L (Gen II) (2bbl) (1993-96), 4.3LX (Gen II) (4bbl) (1993-96), 5.0L 2bbl (1988-95), 5.0LX 4bbl (1988-95), 5.7L (1988-95), 5.7L 2bbl (1996), 5.7L Alpha EFI TBI (1995), 5.7L Bravo EFI TBI (1995), 5.7L Competition SKI (1996), 5.7L EFI (2bbl TBI) (1996), 5.7L MIE (1996), 5.7LX 4bbl (1996), 5.7LX Bravo EFI (Gen+) (1996), 5.7LX EFI 4bbl TBI (1996), Black Scorpion (Gen+) (1996) Para: Del enfriador de aceite al alojamiento del termostato



18-70938
MANGUITO

Reemplaza: 32-8066351
Para: 262 Mag con VST (1996-97), 4.3L-LX (1993-96) Design III, 5.0L-LX (1988-95) Design III, 350Mag-EFI-MPI (1987-96), 5.7L-LX 88-96 Design III.
Para: Del alojamiento de termostato al colector de babor



18-70939
MANGUITO

Reemplaza: 32-8066361
Para: 4.3L-LX (1993-96) Diseño refrigeración estándar III, 5.0L-LX/5.7L-LX (1988-95) estándar Cooling Design III, 350 Mag (1987-95) Refrigeración estándar Design III.
Para: Del alojamiento termostato al colector estribor



18-70940
MANGUITO

Reemplaza: 32-860144
Para: 262 Mag con refrigeración combustible, 4.3L-LX (1996 & Sup) con 1 pc. colector, 5.0L-EFI (1998 & Up), 350 Mag-MPI 97-01, 5.7L-EFI (1996-97), 6.2L MPI (2001 & Sup).
Para: del alojamiento de termostato al colector babor



18-70943
MANGUITO
 Reemplaza: 32-897491
 Para: 7.4L, 454 Mag, 502 Mag. Del alojamiento de termostato al colector de babor



18-3601
MANGUERA ENTRADA AGUA
 Reemplaza: 32-32461, 32-32461A1
 Diámetro. $\frac{5}{8}$ "
 Largo $13 \frac{7}{8}$ "



18-3602
MANGUERA ENTRADA AGUA
 Reemplaza: 32-4172533, 32-8M0062309
 $13 \frac{7}{8}$ " Largo - $\frac{3}{4}$ " D.I.
 Para: MR, Alpha I, Gen II



18-3603
MANGUERA ENTRADA AGUA
 Reemplaza: 32-43437, 32-8M0062309



18-70925
MANGUITO
 Reemplaza: 32-160211, 32-87116, 32-16021
 Para: 4.3L, 5.0L, & 5.7L
 Para: Tapa termostato a colector de babor



18-70926
MANGUITO
 Reemplaza: 32-73796
 Para: 5.0L & 5.7L
 Para: Tapa termostato a codo escape



18-70927
MANGUITO
 Reemplaza: 32-73795
 Para: 5.0L & 5.7L Port
 Para: Para alojamiento al colector de babor



18-70928
MANGUITO
 Reemplaza: 32-71613
 Para: 5.0L & 5.7L
 Para: alojamiento termostato a enfriador aceite



18-70929
MANGUITO
 Reemplaza: 32-73794
 Para: 5.0L & 5.7L Estribor
 Para: alojamiento termostato a colector estribor



18-44092
MANGUITO
TRANSOM
 Reemplaza: Mercury 32-861635
 $1 \frac{1}{4}$ " (32mm) / 1 " (25mm) D.I.
 Para: Mercruiser 3.0L



18-70930
MANGUITO
 Reemplaza: 32-52481
 Para: GM En línea 4 & 6 cil.
 Para: Bloque distribución a tapa.



18-70931
MANGUITO
 Reemplaza: 32-96879, 32-47640,
 32-8M0071007
 Para: 2.5L & 3.0L
 Para: Bloque distribución a bomba agua



18-70932
MANGUITO
 Reemplaza: 32-871171, 32-87117
 Para: 4.3L, 5.0L, & 5.7L Estribor
 Para: Tapa termostato a colector estribor



4 3/4"
18-70021
MANGUITO
 3/4" DI



5"
18-70704
MANGUITO
 Reemplaza: 32-89653
 1 1/4" DI
 Para: 3.7L



5"
18-70924
MANGUITO
 1 3/4" DI



12 1/2"
18-71218
MANGUITO
 Reemplaza: 32-48131
 1" DI
 Para: 230 & 260 MIE



12 3/4"
18-71337
MANGUITO
 Reemplaza: 32-861590A05, 32-861590A2, 32-861590A1,
 32-806825
 1 3/4" DI
 Para: 4.3L, 5.0L, 5.7L
 Manguera bomba circulación

MANGUERAS



18-75100
MANGUERA
 Trozo de 48"
 1" DI



18-75125
MANGUITO
 Trozo de 48"
 1 1/4" DI

INTERCAMBIO MANGUITOS

Ref #	Mercruiser Ref #	Ref #	Mercruiser Ref #	Ref #	Mercruiser Ref #	Ref #	Mercruiser Ref #
18-70925	32-16021 1	18-70928	32-71613	18-70935	32-806856	18-70934	32-89718 1
18-3601	32-32461	18-70929	32-73794	18-70940	32-860144	18-70943	32-89749 1
18-71337	32-33189	18-70927	32-73795	18-70933	32-861634	18-70931	32-96879
18-3602	32-41725-33	18-70926	32-73796	18-71337	32-87108		
18-3603	32-43437	18-70938	32-806635 1	18-70932	32-87117 1		
18-71218	32-48132	18-70939	32-806636 1	18-70704	32-89653		
18-70930	32-52481						

CORREAS

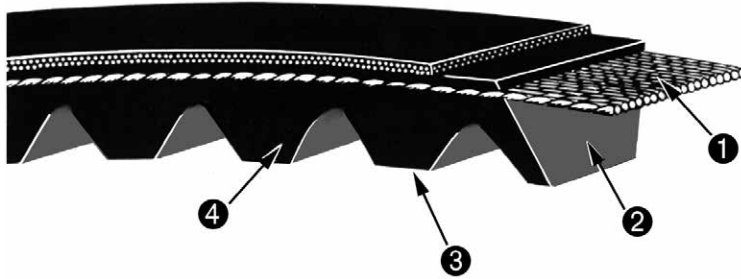

- 1 Cuerdas sintéticas de alta fuerza resiste fallo de carga de choque. Sus bajas propiedades de extensión aseguran el funcionamiento uniforme sobre la vida de la correa.
- 2 La sección de compresión es un compuesto especial de goma que asegura suavidad y la transferencia de carga fuerza a las cuerdas.
- 3 Los dientes son moldeados a tolerancias exactas de ingeniería para mejorar la flexibilidad y mantener el apoyo de cuerda. La geometría de los dientes proporciona un área grande para la circulación de aire para mantener la correa refrigerada y prevenir que el aumento de calor dañe la sección de cojín.
- 4 El estriado facilita que no patinen en contacto con la polea y una transmisión perfecta.

TAMAÑO CORREAS

Ref No.	OE #	Largo (pulgadas)	Ancho máxim(p.)	Ref No.	OE #	Largo (pulgadas)	Ancho máxim(p.)
18-15290	57-13457, 57-13457T, 57-13457Q, 57-53215, 57-53215T	29	29/64	18-15435	57-64416, 57-49211	43 1/2	29/64
18-15300	57-49756	30	29/64	18-15440	57-49213A1, 57-45856	44	29/64
18-15325	57-77274A1, 57-77274	32 1/2	29/64	18-15450	-	45	29/64
18-15345	57-74271T, 57-74271, 57-74271Q	34 1/2	29/64	18-15455	-	45 1/2	29/64
18-15370	57-65607T, 57-65607, 57-65607Q	37	29/64	18-15460	57-48120A1, 57-48120, 57-48120Q1	46	29/64
18-15380	-	38	29/64	18-15470	57-78200A1, 57-78200, 57-78200Q1	47	29/64
18-15390	57-52692	39	29/64	18-15480	57-48122, 57-48122Q	48	29/64
18-15400	57-32850, 57-69143T, 57-69143Q	40	29/64	18-15490	57-816295T, 57-816295Q	52 1/2	29/64
18-15405	57-76269, 57-76269Q	40 1/2	29/64	18-15495	57-91035A1, 57-91035Q1, 57-91035	49 1/2	29/64
18-15410	57-49043A1, 57-64032A1, 57-32850, 57-49043, 57-64032, 57-64032Q1, 57-816544	41	29/64	18-15500	57-96834T, 57-96834Q, 57-96834, 57-13458, 57-13458Q	50	29/64
18-15415	57-36356	41 1/2	29/64	18-15520	57-33170, 57-33170Q, 57-37619T	52	29/64
18-15430	57-49211, 57-64416	43	29/64	18-15550	57-13458T	55	29/64

APLICACIONES CORREAS

Table with columns: HP, Litros, Modelo, Años, CID, # Cil, tiempos, Serie #, Tipo de correo, Alternador/bomba agua, dirección asistida, bomba de agua marina. It lists various engine specifications and belt types for Mercury outboard motors.

- (1) 1/2" ancho (13mm) correa
(2) 3/8" ancho (10mm) correa
(3) 28" ancho (711mm) correa
(4) 30" ancho (762mm) correa
(5) 37" ancho (940mm) correa
(6) 40" ancho (1016mm) correa
(7) 50" ancho (1270mm) correa
(8) 55" ancho (1397mm) correa
(9) Use con 5 1/2" (140mm) dia polea bomba agua

- (10) Use con 5 7/8" (149mm) dia polea bomba de agua
(11) Use con 7" (178mm) dia polea bomba de agua
(12) Use con bomba agua de acero con polea
(13) Use con bomba agua de aluminio con polea
(14) Use con plástico 4 3/4" (121mm) dia p/s bomba polea
(15) Use con metal 5 3/4" (146mm) dia p/s bomba polea
(16) Para motores con alto montaje de bomba p/s
(17) Para motores con bajo montaje de bomba p/s
(18) Para motores con dirección asistida

- (19) Para motores sin dirección asistida
(20) Para motores con refrigeración cerrado
(21) Para motores con refrigeración estándar
(22) Incluye kit de repuesto 5 3/4" (146mm) polea y correa serpiente larga
(23) Para motores con alternador montado alto

APLICACIONES CORREAS

HP	Litros	Modelo	Años	CID	# Cil	Tiempos	Serie #	Tipo de correa	Alternador/ bomba agua	Power Steering	bomba agua marina
		233	1975-77			4	4173000 - 4902304	CORREA	18-15440	—	—
		233	1975-77			4	4173000 - 4902304	CORREA	18-15440	18-15290	18-15345 12
		233 MIE	1975-76			4	4173000 - 4775784	CORREA	18-15440	—	—
5.0L	5.0L		1988-1995	305	8	4	B774445 - F600999	CORREA	— 9	18-15520 9	18-15345 12
5.0L	5.0L		1988-1995	305	8	4	B774445 - F600999	CORREA	18-15460 11	18-15490 11	18-15290 13
5.0L	5.0L ALPHA RWC		1998-1999	305	8	4	L012052 - L618999	SERPENTIN	18-15116	1, 14, 21, 22	—
5.0L	5.0L ALPHA FWC		1998-1999	305	8	4	L012052 - L618999	SERPENTIN	18-15114	14, 20, 22	—
5.0L	5.0L ALPHA RWC		1998-1999	305	8	4	L012052 - L618999	SERPENTIN	18-15116	15, 21	—
5.0L	5.0L ALPHA FWC		1998-1999	305	8	4	L012052 - L618999	SERPENTIN	18-15114	15, 20	—
5.0L	5.0L BRAVO RWC		1998-1999	305	8	4	L012052 - L618999	SERPENTIN	18-15115	1, 14, 20, 22	—
5.0L	5.0L BRAVO FWC		1998-1999	305	8	4	L012052 - L618999	SERPENTIN	18-15114	1, 14, 21, 22	—
5.0L	5.0L BRAVO RWC		1998-1999	305	8	4	L012052 - L618999	SERPENTIN	18-15115	15, 21	—
5.0L	5.0L BRAVO FWC		1998-1999	305	8	4	L012052 - L618999	SERPENTIN	18-15114	15, 20	—
5.0L	5.0L MIE		1988	305	8	4	B788152 - C396832	CORREA	18-15460 11	—	57-13457Q 13
5.0L	5.0LX		1988	305	8	4	6218462 - F600999	CORREA	— 9	18-15520 9	57-74271Q 12
5.0L	5.0LX		1983-1995	305	8	4	6218462 - F600999	CORREA	18-15460 11	18-15490 11	57-13457Q 13
5.0L	5.0L	2bbl	1988-95				B774445-F600999	CORREA	—	18-15490	—
5.0L	5.0LX	4bbl	1988-95			4	B773740-F600999	CORREA	—	18-15490	—
5.0L	898		1977-19884	305	8	4	4782210 - 6218461	CORREA	18-15460 17	18-15325 17	18-15345
5.0L	898		1977-1984	305	8	4	4782210 - 6218461	CORREA	18-15440 16	18-15495	18-15345
5.0L	898		1983-1984	305	8	4	6218462 - 6899057	CORREA	— 9	18-15520 9	18-15345 9
5.0L	898		1983-1984	305	8	4	6218462 - 6899057	CORREA	18-15460 11	18-15490 11	18-15345
5.0L	898 / 200 / 5.0L		1985-1995	305	8	4	6218462 - F600999	CORREA	18-15440 20	18-15495	18-15345
5.0L	898 / 200 / 5.0L		1985-1995	305	8	4	6218462 - F600999	CORREA	18-15460 21	18-15520	18-15290
5.7L	250 MCM / 250 MIE		1968-69	350	8	4	2314301 - 2639854	CORREA	18-15460	—	—
5.7L	250		1977	350	8	4	4788000 - 4908849	CORREA	18-15440	18-15345	18-15345
5.7L	255 MCM / 255 MIE		1973-74	350	8	4	3258728 - 4175499	CORREA	18-15440	—	—
5.7L	255	GM	1975-76	350	8	4	4175500 - 4498700	CORREA	18-15460	18-15300	18-15345
5.7L	255	GM	1976	350	8	4	4498701-4499060	CORREA	18-15460	—	18-15345
5.7L	255	GM	1976	350	8	4	4499061-4767999	CORREA	18-15460	—	18-15345
5.7L	255 MIE	GM	1975-77	350	8	4	4175500 - 4498700	CORREA	18-15460	—	18-15345
5.7L	255 MIE	GM	1977-78	350	8	4	4498701 - 4924564	CORREA	18-15460	—	18-15345
5.7L	255 MIE	GM	1978-1980	350	8	4	4924565 - 5907057	CORREA	—	—	18-15345
5.7L	260 MIE		1978-86	350	8	4	4924565 - B522505	CORREA	18-15440	—	18-15345
5.7L	260 / 5.7L MIE / 5.7L Ski		1987-93	350	8	4	B522506 - F024999	CORREA	18-15440	—	18-15345 12
5.7L	260 / 5.7L MIE / 5.7L Ski		1987-93	350	8	4	B522506 - F024999	CORREA	18-15460	—	18-15290 13
5.7L	260		1978-1982	350	8	4	4908850 - 6218461	CORREA	18-15440 16	18-15495 17	18-15345
5.7L	260		1978-1982	350	8	4	4908850 - 6218461	CORREA	18-15460 17	—	18-15345
5.7L	260		1987	350	8	4	B525982-B773304	CORREA	—	18-15490	—
5.7L	260		1983-1987	350	8	4	6218462 - B773304	CORREA	18-15460 11	18-15490 11	18-15290 13
5.7L	260 MIE		1987	350	8	4	B522506 - B788151	CORREA	18-15460 11	—	18-15290 13
5.7L	260 / 5.7L		1983-1995	350	8	4	6218462 - F600999	CORREA	18-15440	18-15495	18-15345 20
5.7L	260 / 5.7L		1983-1995	350	8	4	6218462 - F600999	CORREA	18-15460	18-15520	18-15290 21
5.7L	270 MCM / 270 MIE		1969-1972	350	8	4	2851074 - 3385720	CORREA	18-15460	—	—
5.7L	280 TRS		1975	350	8	4	4178250 - 4178468	CORREA	18-15460	—	—
5.7L	280 TRS		1975	350	8	4	4178250 - 4178468	CORREA	18-15460	18-15300	—
5.7L	280 TRS		1975-76	350	8	4	4178469 - 4499390	CORREA	18-15460	18-15300	—
5.7L	280 TRS		1976	350	8	4	4499391 - 4499780	CORREA	18-15460	—	—
5.7L	280 TRS		1976	350	8	4	4499781 - 4770199	CORREA	18-15460	18-15325	—
		320 EFI	1987-89			8	A543804 - C622418	CORREA	18-15440	18-15520	—
		330	1977-81			8	4623115-6083144		18-15470	—	18-15345
		330	1982-87			8	6083144 - B816540		18-15470	18-15500	18-15345 12
		330	1982-87			8	6083144 - B816540		18-15470	18-15550	18-15290 13
5.7L	350 MAG ALPHA		1986-1995	350	8	4	A635178 - F600999	CORREA	18-15440 9	18-15520 9	18-15345 20
5.7L	350 MAG ALPHA		1986-1995	350	8	4	A635178 - F600999	CORREA	18-15460 11	18-15490 11	18-15290 21
5.7L	350 MAG ALPHA		1996	350	8	4	F601000 - K001500	CORREA	18-15460	18-15490	18-15290
5.7L	350 Mag Alpha		1987-1995	350	8	4	B525982 - F600999	CORREA	—	18-15490	—
5.7L	350 Mag Alpha	4bbl	1996	350	8	4	F601000 - K001526	CORREA	—	18-15490	—
5.7L	350 Mag Alpha EFI / 350 Mag ALPHA Gen+		1996	350	8	4	F800300 - K001508	CORREA	—	18-15490	—
5.7L	350 Mag Bravo MPI / 350 Mag Bravo MPI Gen+		1995	350	8	4	F415189 - F601999	CORREA	—	18-15490	—
5.7L	350 MAG SKI		1991-96	350	8	4	F602000 - K001500	CORREA	—	18-15490	—
5.7L	350 MAG ALPHA RWC		1997-1999	350	8	4	D505450 - K040005	CORREA	18-15460	—	18-15290
5.7L	350 MAG ALPHA FWC		1997-1999	350	8	4	K001501 - L618999	SERPENTIN	18-15116	14, 21, 22	—
5.7L	350 MAG ALPHA RWC		1997-1999	350	8	4	K001501 - L618999	SERPENTIN	18-15114	14, 20, 22	—
5.7L	350 MAG ALPHA RWC		1997-1999	350	8	4	K001501 - L618999	SERPENTIN	18-15116	15, 20	—
5.7L	350 MAG ALPHA FWC		1997-1999	350	8	4	K001501 - L618999	SERPENTIN	18-15114	15, 21	—
5.7L	350 MAG BRAVO RWC		1997-1999	350	8	4	K001501 - L618999	SERPENTIN	18-15115	14, 21, 22	—
5.7L	350 MAG BRAVO FWC		1997-1999	350	8	4	K001501 - L618999	SERPENTIN	18-15114	14, 20, 22	—
5.7L	350 MAG BRAVO RWC		1997-1999	350	8	4	K001501 - L618999	SERPENTIN	18-15115	15, 21	—
5.7L	350 MAG BRAVO FWC		1997-1999	350	8	4	K001501 - L618999	SERPENTIN	18-15114	15, 20	—
5.7L	350 MIE		1974-75	350	8	4	3780450-4501640		18-15480	—	—
5.7L	350 MIE		1976	350	8	4	4501641 - 4623109		18-15480	—	18-15345
5.7L	350 MAG MPI / 350 MAG SKI		1995-1996	350	8	4	F350583 - F799999	CORREA	18-15460	—	18-15290
5.7L	350 MAG SKI		1991-1996	350	8	4	D505450 - K040005	CORREA	18-15460	—	18-15290 12
5.7L	5.7L		1988-1995	350	8	4	B773305 - F600999	CORREA	— 9	18-15520 9	18-15345
5.7L	5.7L		1988-1995	350	8	4	B773305 - F600999	CORREA	18-15460 11	18-15490 11	18-15290
5.7L	5.7L		1996	350	8	4	F601000 - K001505	CORREA	18-15460	18-15490	18-15290
5.7L	5.7L ALPHA RWC		1997-1999	350	8	4	K001506 - L618999	SERPENTIN	18-15116	14, 21, 22	—
5.7L	5.7L ALPHA FWC		1997-1999	350	8	4	K001506 - L618999	SERPENTIN	18-15114	14, 20, 22	—
5.7L	5.7L ALPHA RWC		1997-1999	350	8	4	K001506 - L618999	SERPENTIN	18-15116	15, 21	—
5.7L	5.7L ALPHA FWC		1997-1999	350	8	4	K001506 - L618999	SERPENTIN	18-15114	15, 20	—
5.7L	5.7L BRAVO RWC		1997-1999	350	8	4	K001506 - L618999	SERPENTIN	18-15114	14, 20, 22	—
5.7L	5.7L BRAVO RWC		1997-1999	350	8	4	K001506 - L618999	SERPENTIN	18-15115	15, 21	—
5.7L	5.7L BRAVO FWC		1997-1999	350	8	4	K001506 - L618999	SERPENTIN	18-15114	15, 20	—
5.7L	5.7L MIE		1988-1993	350	8	4	B522506 - F024999	CORREA	—	—	18-15345
5.7L	5.7L MIE		1988-1993	350	8	4	B522506 - F024999	CORREA	—	—	18-15290
5.7L	5.7L MIE		1994-1996	350	8	4	F025000 - K040306	CORREA	18-15460	—	18-15290
5.7L	5.7L SKI		1985-1987	350	8	4	A338553 - B514626	CORREA	—	—	18-15290 13
5.7L	5.7L SKI		1987-1995	350	8	4	B514627 - F775199	CORREA	—	—	18-15345
5.7L	5.7L SKI		1987-1995	350	8	4	B514627 - F775199	CORREA	—	—	18-15290
5.7L	5.7L SKI		1996	350	8	4	F775200 - K040003	CORREA	18-15460	—	18-15290
5.7L	5.7LX		1996	350	8	4	F601000 - K001505	CORREA	18-15460	18-15490	18-15290
5.7L	5.7LX BRAVO EFI		1996	350	8	4	F800300 - K001505	CORREA	18-15460	18-15490	18-15290
5.7L	5.7LX BRAVO		1996	350	8	4	F601000 - K001505	CORREA	18-15460	18-15490	18-15290
5.7L	BLACK SCORPION SKI		1996	350	8	4	F800000 - K040000	CORREA	18-15460	—	18-15290

- (1) 1/2" ancho (13mm) correa
- (2) 3/8" ancho (10mm) correa
- (3) 28" ancho (711mm) correa
- (4) 30" ancho (762mm) correa
- (5) 37" ancho (940mm) correa
- (6) 40" ancho (1016mm) correa
- (7) 50" ancho (1270mm) correa
- (8) 55" ancho (1397mm) correa
- (9) Use con 5 1/2" (140mm) dia polea bomba agua

- (10) Use con 5 7/8" (149mm) dia polea bomba agua
- (11) Use con 7" (178mm) dia polea bomba de agua
- (12) Use con bomba agua de acero con polea
- (13) Use con bomba agua de aluminio con polea
- (14) Use con plástico 4 3/4" (121mm) dia polea bomba p/s
- (15) Use con metal 5 3/4" (146mm) dia polea bomba p/s
- (16) Para motores con alto montaje de bomba p/s
- (17) Para motores con bajo montaje de bomba p/s
- (18) Para motores con dirección asistida

- (19) Para motores sin dirección asistida
- (20) Para motores con refrigeración cerrado
- (21) Para motores con refrigeración estándar
- (22) Incluye kit de rep

APLICACIONES CORREAS

HP	Litros	Modelo	Años	CID	# Cil	tiempos	Serie #	Tipo de correa	Alternador/ bomba agua	Dirección asistida	bomba agua marina
	5.7L	5.7L MIE / 5.7L Ski	1994-96	350	8	4	F025000 - K040306		18-15460	—	—
	5.7L	5.7L	1988-96	350	8	4	B525982 - F600999		—	18-15490	—
	5.7L	5.7L 2bbl	1996	350	8	4	F601000 - K001526		—	18-15490	—
	5.7L	5.7L EFI 2bbl	1996	350	8	4	F752400 - K001505		—	18-15490	—
	5.7L	5.7L Alpha EFI / 5.7L ALPHA TBI	1995	350	8	4	F355305 - F752389		—	18-15490	—
	5.7L	5.7L Alpha EFI / 5.7L ALPHA TBI	1995	350	8	4	F225560 - F752399		—	18-15490	13
	5.7L	5.7LX EFI / 5.7LX TBI	1996	350	8	4	F752400 - K001505		—	18-15490	12
	5.7L	233	1975-1977	351	8	4	4173000 - 4902304	CORREA	—	18-15290 30° CORREA	18-15345
	6.2L	377 SCORPION MCM	1999-2005	377	8	4	L416146 - M907201	SERPENTIN	—	—	—
	7.4L	325 MCM / 325 MIE	1968-1974	427	8	4	2278747 - 3780449	CORREA	18-15480	—	—
	7.4L	330	1977-1981	454	8	4	4623115 - 6083144	CORREA	18-15470	—	18-15345
	7.4L	330	1982-1987	454	8	4	6083145 - B816540	CORREA	18-15470	18-15500 50° CORREA	18-15345 12
	7.4L	330	1982-1987	454	8	4	6083145 - B816540	CORREA	18-15470	18-15500 55° CORREA	18-15290 13
	7.4L	330 MIE	1977-1980	454	8	4	4623115 - 5889913	CORREA	18-15470	—	18-15345
	7.4L	340 MIE	1981-1987	454	8	4	5889914 - B788365	CORREA	18-15470	—	18-15345 12
	7.4L	340 MIE	1981-1987	454	8	4	5889914 - B788365	CORREA	18-15470	—	18-15290 13
	7.4L	340	1981-92	454	8	4	5889914 - D715493	CORREA	18-15470	—	18-15345 12
	7.4L	340	1981-92	454	8	4	5889914 - D715493	CORREA	18-15470	—	18-15290 13
	7.4L	350 MIE	1974-1975	454	8	4	3780450 - 4501640	CORREA	18-15480	—	—
	7.4L	350 MIE	1976	454	8	4	4501641 - 4623109	CORREA	18-15480	—	18-15345
	7.4L	370 TRS	1978-1985	454	8	4	4179554 - 6721527	CORREA	18-15480	—	—
	7.4L	370 TRS	1985-1987	454	8	4	6721528 - B714586	CORREA	18-15480	18-15500	18-15345
	7.4L	400 TRS	1980-1986	454	8	4	4179554 - B457644	CORREA	18-15480	—	—
	7.4L	420	1987-1989	454	8	4	A398941 - B622418	CORREA	—	18-15500	18-15345
	7.4L	425	1990-1992	454	8	4	B622419 - D725499	CORREA	—	18-15500	18-15345
	7.4L	425	1992	454	8	4	D725500 - D937011	CORREA	—	—	18-15400
	7.4L	440 TRS	1983-1986	454	8	4	4179554 - B485220	CORREA	18-15480	—	—
	7.4L	450	1995-1996	454	8	4	F347100 - F347277	CORREA	—	—	18-15400
	7.4L	454 MAG ALPHA	1986-1988	454	8	4	A631894 - B785148	CORREA	18-15470	18-15500 50° CORREA	—
	7.4L	454 MAG ALPHA	1986-1988	454	8	4	A631894 - B785148	CORREA	18-15470	18-15500 55° CORREA	—
	7.4L	454 MAG	1988-92	454	8	4	B712106 - D805068	CORREA	18-15480	—	18-15290
	7.4L	454 MAG	1988-92	454	8	4	B712106 - D805068	CORREA	18-15480	—	18-15290
	7.4L	454 MAG	1992-97	454	8	4	D805069 - K999999	CORREA	18-15480	—	18-15400
	7.4L	454 MAG MPI	1994-97	454	8	4	F115700 - K147349	CORREA	18-15480	—	18-15400
	7.4L	454 MAG MPI	1997	454	8	4	K147350 - K999999	CORREA	18-15480	—	18-15290
	7.4L	454 MAG Ski	1995-97	454	8	4	F215800 - K999999	CORREA	18-15480	—	18-15400
	7.4L	454 MAG BRAVO	1988-1992	454	8	4	B712106 - D805068	CORREA	18-15470 9	18-15500 9	18-15290
	7.4L	454 MAG BRAVO	1988-1992	454	8	4	B712106 - D805068	CORREA	18-15480 11	— 11	18-15290
	7.4L	454 MAG BRAVO	1992-1997	454	8	4	D805069 - K999999	CORREA	18-15480	—	18-15400
	7.4L	454 MAG EFI	1994-1996	464	8	4	F115700 - F802349	CORREA	18-15480	—	18-15400
	7.4L	454 MAG EFI SKI	1995-1996	454	8	4	F215800 - F820099	CORREA	18-15480	—	18-15400
	7.4L	454 MAG MPI	1996-1997	454	8	4	F115700 - F147349	CORREA	18-15480	—	18-15400
	7.4L	454 MAG MPI	1997	454	8	4	K147350 - K999999	CORREA	18-15480	—	18-15290
	7.4L	525 SC	1991-1999	454	8	4	D456000 - L415623	CORREA	—	18-15500	18-15400
	7.4L	7.4L BRAVO	1988-1991	454	8	4	B711113 - D803117	CORREA	18-15470	18-15500 9	18-15290
	7.4L	7.4L BRAVO	1988-1991	454	8	4	B711113 - D803117	CORREA	18-15480	— 11	18-15290
	7.4L	7.4L BRAVO	1992-1997	454	8	4	D603118 - K999999	CORREA	18-15480	—	18-15400
	7.4L	7.4L MIE WITH B/W	1988-1992	454	8	4	B788366 - D715493	CORREA	18-15470	—	18-15290
	7.4L	7.4L MIE WITH B/W	1988-1992	454	8	4	B788366 - D715493	CORREA	18-15470	—	18-15400
	7.4L	7.4L MIE WITH HURTH	1989-1992	454	8	4	C391564 - D715493	CORREA	18-15470 10	—	18-15290 12
	7.4L	7.4L MIE WITH HURTH	1989-1992	454	8	4	C391564 - D715493	CORREA	18-15480 11	—	18-15290 13
	7.4L	7.4L MIE	1992-1997	454	8	4	D715494 - K999999	CORREA	18-15480	—	18-15400
	7.4L	7.4L MPI	1998-2001	454	8	4	L010003 - M024330	SERPENTIN	18-15114 14, 22	—	—
	7.4L	7.4L MPI	1998-2001	454	8	4	L010003 - M024330	SERPENTIN	18-15114 14	—	—
	7.4L	7.4L MPI / 7.4L MIE	1995-1996	454	8	4	F563052 - F820131	CORREA	18-15480	—	18-15400
	7.4L	7.4L MPI / 7.4L MIE	1996-1997	454	8	4	F820132 - K999999	CORREA	18-15480	—	18-15290
	7.4L	7.4LX BRAVO EFI	1996-1997	454	8	4	F820000 - K999999	CORREA	18-15480	—	18-15290
	7.4L	7.4LX BRAVO MPI	1996-1997	454	8	4	F602010 - K147349	CORREA	18-15480	—	18-15400
	7.4L	7.4LX BRAVO MPI	1997	454	8	4	K147350 - K999999	CORREA	18-15480	—	18-15290
	7.4L	7.4LX Bravo MPI	1996-97	454	8	4	F602010 - K147349	CORREA	18-15480	—	18-15400
	7.4L	7.4L MIE	1992-97	454	8	4	C391564 - K999999	CORREA	18-15480	—	18-15400
	7.4L	370 TRS	1978-85	8	4	4	4179554 - 6721527	—	18-15480	—	—
	7.4L	370 TRS	1985-87	8	4	4	6721528 - B714586	—	18-15480	18-15500	—
		390 MCM / 390 MIE	1969-1970	482	8	4	2781129 - 3042731	CORREA	18-15480	—	—
		400 TRS	1983-1986	482	8	4	4179554 - 6181046	CORREA	18-15480	—	—
		420/425	1987-1992	8	4	4	A398941 - D725499	CORREA	18-15480	18-15500	—
		420 / 425	1992	8	4	4	D725500 - D937011	CORREA	18-15480	—	18-15400
		440 TRS	1983-1986	8	4	4	4179554 - B485220	CORREA	18-15480	—	—
		450	1995-1996	8	4	4	F347100 - F347277	CORREA	18-15480	—	18-15400
		460 TRS	1983-1986	8	4	4	4179554 - 6181046	CORREA	18-15480	—	—
		465	1990-1992	502	8	4	C849992 - D725646	CORREA	—	—	18-15290
	8.2L	465	1992-1994	502	8	4	D725647 - F213244	CORREA	—	—	18-15400
	8.2L	500	1994-1998	502	8	4	F213293 - L001772	CORREA	—	—	18-15400
	8.2L	500 GEN +	1999	502	8	4	L414639 - L601036	CORREA	—	—	18-15400
	8.2L	502 MAG BRAVO	1990-1997	502	8	4	C878221 - D824588	CORREA	18-15480	—	18-15290
	8.2L	502 MAG BRAVO	1990-1997	502	8	4	C824589 - K999999	CORREA	18-15480	—	18-15400
	8.2L	502 MAG EFI	1994-1995	502	8	4	D840650 - F802599	CORREA	18-15480	—	18-15400
	8.2L	502 MAG MPI	1996-1997	502	8	4	F802600 - K147349	CORREA	18-15480	—	18-15400
	8.2L	502 MAG MPI	1997	502	8	4	K147350 - K999999	CORREA	18-15480	—	18-15290
	8.2L	502 MAG MPI	1998-2001	502	8	4	L017000 - M024999	SERPENTIN	18-15114 14, 22	—	—
	8.2L	502 MAG MPI	1998-2001	502	8	4	L017000 - M024999	SERPENTIN	18-15114 14	—	—
	8.2L	600 SC	1991-1992	502	8	4	D456489 - D456768	CORREA	—	18-15500	18-15345
	8.2L	600 SC	1992-2000	502	8	4	D725676 - L601186	CORREA	—	18-15500	18-15400
	8.2L	8.2L MIE	1990-1993	502	8	4	C878221 - D857199	CORREA	18-15480	—	18-15290
	8.2L	8.2L MIE	1993-1997	502	8	4	D857200 - K999999	CORREA	18-15480	—	18-15400
	8.2L	8.2L MPI MIE	1996-1997	502	8	4	F819620 - K147349	CORREA	18-15480	—	18-15400
	8.2L	8.2L MPI MIE	1997	502	8	4	K147350 - K999999	CORREA	18-15480	—	18-15290
	8.2L	500 BULDOG	1990-2001	540	8	4	C577254 - M050281	CORREA	— 3/8" BELT WIDTH	—	18-15345
	8.2L	500 BULDOG	1990-2001	540	8	4	C577254 - M050281	CORREA	— 1/2" BELT WIDTH	—	18-15345

- (1) 1/2" ancho (13mm) correa
- (2) 3/8" ancho (10mm) correa
- (3) 28" ancho (711mm) correa
- (4) 30" ancho (762mm) correa
- (5) 37" ancho (940mm) correa
- (6) 40" ancho (1016mm) correa
- (7) 50" ancho (1270mm) correa
- (8) 55" ancho (1397mm) correa
- (9) Use con 5 1/2" (140mm) dia polea bomba agua

- (10) Use con 5 7/8" (149mm) dia polea bomba de agua
- (11) Use con 7" (178mm) dia polea bomba de agua
- (12) Use una bomba agua de acero con polea
- (13) Use con bomba agua de aluminio con polea
- (14) Use con plástico 4 3/4" (121mm) dia polea bomba p/s
- (15) Use con metal 5 3/4" (146mm) dia polea bomba p/s
- (16) Para motores con alto montaje bomba p/s
- (17) Para motores con bajo montaje bomba p/s
- (18) Para motores con dirección asistida

- (19) Para motores sin dirección asistida
- (20) Para motores con refrigeración cerrado
- (21) Para motores con refrigeración estándar
- (22) Incluye kit de repuesto 5 3/4" (146mm) polea y correa serpiente larga
- (23) Para motores con alternador alto montaje

CORREA SERPENTIN



INTERCAMBIO DE CORREAS

Ref No.	OE #	ancho	Largo (pulg.)	Ref No.	OE #	ancho	Largo (pulg.)
18-15100	57-8638763, 57-862807, 57-862087A1, 57-865615003, 57-865615Q03	13/16	106.25	18-15112	57-8077554, 57-807755Q04	13/16	88
18-15101	57-8638764, 57-862086, 57-8620861, 57-862086A1, 57-865615004, 57-865615Q04	13/16	76.5	18-15114	57-861049, 57-861049Q	13/16	104.25
18-15102	57-8638766, 57-8610491, 57-865615006, 57-865615Q06	13/16	105	18-15115	57-861757, 57-861757Q	13/16	97.5
18-15103	57-8638767, 57-865615007, 57-861050, 57-865615Q07	13/16	96.75	18-15116	57-861758, 57-861758Q	13/16	86.75
18-15104	57-8638768, 57-862089, 57-862089A1, 57-865615008, 57-865615Q08	13/16	99.5	18-15119	57-8638761, 57-8623523, 57-865615001, 57-865615Q01	13/16	111.25
18-15105	57-8638769, 57-865615009, 57-862088, 57-862088A1, 57-865615Q09	13/16	69.75	18-15121	57-865615005, 57-865615Q05, 57-8638765, 57-865423005	13/16	87.5
				18-15122	57-865615010, 57-86387610, 57-865615Q10	13/16	86
				18-15123	57-864639	13/16	85
				18-15125	57-817113	1 3/8	53.5

APLICACIÓN CORREA

Motores	Años	Serie #	Ref #	Mercruiser #	Nota pie	Motores	Años	Serie #	Ref #	Mercruiser #	Nota pie
4.3L Alpha	1996-99	OF803000-OL618999	18-15116	57-861758	2, 6	5.7L Bravo	2002-04	OM600000 & sup	18-15102	57-863876 6	3, 5, 7
4.3L Alpha	2000-04	OL619000 & sup	18-15101	57-863876 4	3, 6, 7	5.7L Bravo	2000-04	OL619000 & sup	18-15104	57-863876 8	4, 7
4.3L Alpha	2000-04	OL619000 & sup	18-15104	57-863876 8	4, 5, 7	5.7L Ski	1997-02	OK040004-OM316999	18-15112	57-8077554	
4.3L Alpha	2000-04	OL619000 & sup	18-15105	57-865615009	4, 6, 7	5.7L Ski	2002-05	OM317000 & sup	18-15121	57-865615005	
4.3L Bravo	1996-99	OF803000-OL618999	18-15114	57-861049	2, 5	5.7L MIE	2001-05	OL677227 & sup	18-15121	57-865615005	
4.3L Bravo	1996-99	OF803000-OL618999	18-15115	57-861757	2, 6	377 Scorpion MCM	1999-04	OL416146 & sup	18-15115	57-861757	
4.3L Bravo	2000-04	OL619000 & sup	18-15104	57-863876 8	4, 7	377 Scorpion Ski	1997-98	OK000656 & sup	18-15112	57-8077554	
5.0L Bravo	2002-04	OM600000 & sup	18-15102	57-863876 6	3, 5, 7	454 Mag MPI	1998-01	OL010029-OM024999	18-15114	57-861049	1
5.0L Alpha	1998-99	OL012052-OL618999	18-15114	57-861049	5	454 Mag MPI	1998-01	OL010029-OM024999	18-15102	57-863876 6	2
5.0L Alpha	1998-99	OL012052-OL618999	18-15116	57-861758	2, 6	454 Mag MPI	1998-01	OL010029-OM024999	18-15103	57-865615007	4
5.0L Alpha	2000-04	OL619000 & sup	18-15101	57-863876 4	3, 6, 7	454 Mag MPI Horizon MIE	1998-01	OL002200-OL674000	18-15103	57-865615007	
5.0L Alpha	2002-04	OM600000 & sup	18-15102	57-863876 6	3, 5, 7	496 Mag & HO	2000-04	OM025000 & sup	18-15119	57-863876 1	
5.0L Alpha	2001-04	OL619000 & sup	18-15104	57-863876 8	4, 5, 7	500 EFI	1999-04	OL001477 & sup	18-15112	57-8077554	
5.0L Alpha	2000-04	OL619000 & sup	18-15105	57-865615009	4, 6, 7	502 Mag MPI	1998-01	OL017000-OM024999	18-15114	57-861049	1
5.0L Bravo	1998-99	OL012052-OL618999	18-15114	57-861049	2, 5	502 Mag MPI	1998-01	OL017000-OM024999	18-15103	57-865615007	4
5.0L Bravo	1998-99	OL012052-OL618999	18-15115	57-861757	2, 6	502 Mag. MPI	1998-01	OL017000-OM024999	18-15102	57-863876 6	2
5.0L Bravo	2000-04	OL619000 & sup	18-15104	57-863876 8	4, 7	525 SC	1991-96	OD456000-745215	18-15125	57-817113	
350 Mag, Alpha	1997-04	OK001501-OL618999	18-15114	57-861049	2, 5	575 Sci	2000-05	OL306696 & sup	18-15125	57-817113	8
350 Mag, Alpha	1997-04	OK001501-OL618999	18-15116	57-861758	2, 6	575 Sci	2000-05	OL306696 & sup	18-15112	57-8077554	9
350 Mag, Alpha	2000-04	OL619000 & sup	18-15103	57-865615007	3, 6, 7	600 SC	1991-96	OD456489-OF877462	18-15125	57-817113	
350 Mag, Alpha	2002-04	OM600000 & sup	18-15102	57-863876 6	3, 5, 7	600 SC	1998	OK000227 & sup	18-15125	57-817113	
350 Mag, Alpha	2000-04	OL619000 & sup	18-15104	57-863876 8	4, 5, 7	7.4L MPI	1998-01	OL010003-OM024330	18-15114	57-861049	1
350 Mag, Alpha	2000-04	OL619000 & sup	18-15105	57-865615009	4, 6, 7	7.4L MPI	1998-01	OL010003-OM024330	18-15102	57-863876 6	2
350 Mag, Bravo	1997-04	OK001501-OL618999	18-15114	57-861049	2, 5	7.4L MPI	1998-01	OL010003-OM024330	18-15103	57-865615007	4
350 Mag, Bravo	1997-04	OK001501-OL618999	18-15115	57-861757	2, 6	7.4L MPI MIE	1998-01	OL002006-OM025999	18-15103	57-865615007	
350 Mag, Bravo	2002-04	OM600000 & sup	18-15102	57-863876 6	3, 5, 7	Black Scorpion Ski	1997-01	OK040001-OM391599	18-15112	57-8077554	
350 Mag, Bravo	2000-04	OL619000 & sup	18-15104	57-863876 8	4, 7	Black Scorpion Ski	2003-05	OM391600 & sup	18-15121	57-865615005	
350 Mag MPI MIE	2001-05	OL678399-sup	18-15121	57-865615005	6	MX 6.2L Bk Scorpion Ski	2001	OL670015-OM391599	18-15112	57-8077554	
350 Mag MPI MIE	2002-05	OM317000 & sup	18-15122	57-865615010	5	MX 6.2L MPI	2002-04	OM600000 & sup	18-15102	57-863876 6	3, 5
350 Mag MPI Ski	2001-05	OM300000 & sup	18-15121	57-865615005		MX 6.2L MPI	2000-04	OL680003 & sup	18-15104	57-863876 8	4, 7
350 Mag MPI Horizon MIE	2001-02	OL678399-OM316999	18-15121	57-865615005		MX 6.2L MPI Horizon	2002-04	OM600000 & sup	18-15102	57-863876 6	3
350 Mag MPI Horizon MIE	2001-05	OM317000 & sup	18-15122	57-865615010		MX 6.2L MPI Horizon	2001-04	OM300000 & sup	18-15104	57-863876 8	4
5.7L Alpha	1997-99	OK001501-OL618999	18-15114	57-861049	2, 5	MX 6.2L MPI Horizon MIE	2001	OM300000-OM310099	18-15112	57-8077554	
5.7L Alpha	1997-99	OK001506-OL618999	18-15116	57-861758	2, 6	MX 6.2L MPI Horizon MIE	2001-05	OM310100 & sup	18-15121	57-865615005	6
5.7L Alpha	2000-04	OL619000 & sup	18-15101	57-863876 4	3, 6, 7	MX 6.2L MPI Horizon MIE	2002-05	OM317000 & sup	18-15122	57-865615010	5
5.7L Alpha	2002-04	OM600000 & sup	18-15102	57-863876 6	3, 5, 7	MX 6.2L MPI MIE	1999-01	OL670000-OM310099	18-15112	57-8077554	
5.7L Alpha	2000-04	OL619000 & sup	18-15104	57-863876 8	4, 5, 7	MX 6.2L MPI MIE	2001-05	OM310100 & sup	18-15121	57-865615005	6
5.7L Alpha	2000-05	OL619000 & sup	18-15105	57-865615009	4, 6, 7	MX 6.2L MPI MIE	2002-05	OM317000 & sup	18-15122	57-865615010	5
5.7L Bravo	1997-99	OK001506-OL618999	18-15114	57-861049	2, 5	MX 6.2L MPI Ski	2002-05	OM317000 & sup	18-15121	57-865615005	
5.7L Bravo	1997-99	OK001506-OL618999	18-15115	57-861757	2, 6	8.2L MPI MIE	1998-01	OL002450-OL674200	18-15103	57-865615007	

Nota al pie

1: Usar en bombas de dirección con polea de plástico de 4-3/4"

2: Usar en bombas con polea de metal 5-3/4"

3: Para motores con bomba dirección

4: Para motores sin bomba dirección

5: Para motores con refrigeración cerrada

6: Para motores con refrigeración estándar

7: Motores con altos alternadores montados

8: ventilador

9: Alternador

Fits GM Big Block V8 454 cu. in. Models 330, 340 & 7.4L

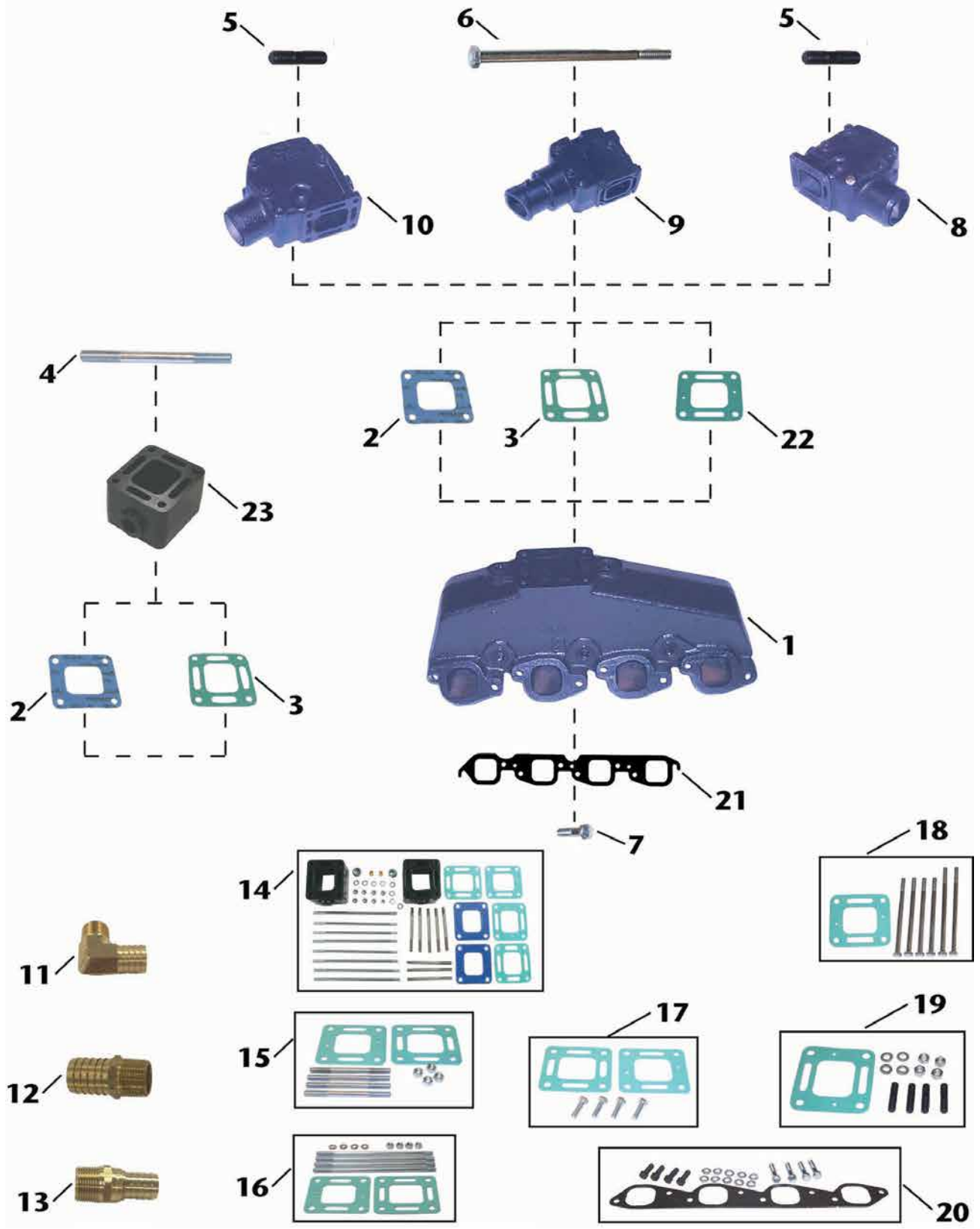

Ref	Descripción	OE No.	Aplicación
1	18-1957-1 COLECTOR	807078A6	Bloque grande GM (V8) 454 cu.in. Modelos 330, 340 & 7.4L. Usar con 18-0418 Junta colector; Kit montaje: 18-8532
2	18-0672 JUNTA CODO (CERRADO)	27-860231	Para colector: 18-1957-1; codos: 18-1970-1, & 18-1976-2, 18-1974: espaciador 18-1908.
3	18-2849-1 JUNTA CODO (ABIERTO)	27-818832	Para colector: 18-1957-1; codos: 18-1970-1, & 18-1976-2, 18-1974: Espaciador 18-1908.
4	NSS ESPARRAGO	N/D	Incluye en 18-8554 kit montaje.
5	NSS ESPARRAGO	N/D	Incluye en 18-8529 kit montaje.
6	NSS PERNO	N/D	Incluye en 18-8505 kit montaje.
7	NSS PERNO	N/D	Incluye en 18-8532 kit montaje.
8	18-1974-1 CODO 3" mang. • 15° angulo	98502A2	Para colector: 18-1957-1. Usar juntas codo: 18-2849-1, 18-0897, o 18-0672; Usar montaje kit: 18-8529 (No usar con espaciador)
9	18-1976-2 CODO 4" mang. • 7° angulo	44354A3	Para colector: 18-1957-1. Usar junta codos: 18-2849-1, 18-0897, o 18-0672; Usar kit montaje: 18-8505, o si el espaciador esta incluido usar 18-8555
10	18-1970-1 CODO 3" manguera	98504A3	Para colector: 18-1957-1. Usar junta codo: 18-2849-1, 18-0897, or 18-0672; Usar kit montaje: 18-8529, o s el espaciador esta incluido usar 18-8554.
11	18-8216 ENTRONQUE	N/D	3/4" - 14NPT X 1" manguera (Entronque de bronce resistente a la corrosión)
12	18-4461 ENTRONQUE	N/D	3/4" - 14NPT X 1" manguera (entronque de bronce resistente a la corrosión)
13	18-8215 ENTRONQUE	N/D	3/4" - 14NPT X 3/4" manguera (Entronque de bronce resistente a la corrosión)
14	18-1908K KIT ESPAC. COLECTOR	807476A6, 93320A5	3" kit codo para colector: 18-1957-1. Incluye (2) espaciadores, restrictor, abierto, & junta. Toda la tornillería necesaria para su montaje.
15	18-8554 KIT DE MONTAJE	N/D	Usar kit de montaje 18-8554 cuando el espaciador 18-1908, codo 18-1970-1 y el codo 18-1974 se utilizan juntos. Incluido en 18-1908K. Incluye (1)juntas de codo 18-2849-1 & 18-0897.
16	18-8555 KIT DE MONTAJE	N/D	Usar con espaciador colector: 18-1908 con codo 18-1976-2. Incluye en 18-1908K. Incluye (1) juntas de codo 18-2849-1 & 18-0897 .
17	18-8556 KIT DE MONTAJE	N/D	Usar con espaciador colector: 18-1985. Incluye (1)juntas 18-2849-1 & 18-0897
18	18-8505 KIT DE MONTAJE	N/D	Usar con codo: 18-1976-2. Incluye juntas codo 18-0897.
19	18-8529 KIT DE MONTAJE	N/D	Usar con codo: 18-1970-1 & 18-1974-1. Incluye juntas codo 18-0897
20	18-8532 KIT DE MONTAJE	N/D	Usar con colector: 18-1957-1. Incluye junta colector 18-0418.
21	18-0418 KIT DE MONTAJE	96653 / 27-46820	Usar con colector: 18-1957-1. Incluye en kit montaje 18-8532.
22	18-0897 JUNTA CODO (RESTRICTOR)	27-41813	Para colector: 18-1957-1; Espaciadores de colector: 18-1985, & 18-1908; Codos: 18-1970-1, & 18-1976-2, 18-1974
23	18-1908 ESPACIADOR COLECTOR	93322A12	3" Espaciador colector: 18-1952-1. Usar con kit montaje 18-8556. (Nota: para montar codos al espaciador es necesario un kit separado)

Fits GM In-Line 6 Cylinder 250 & 292 cu. in. Models 165 & 200

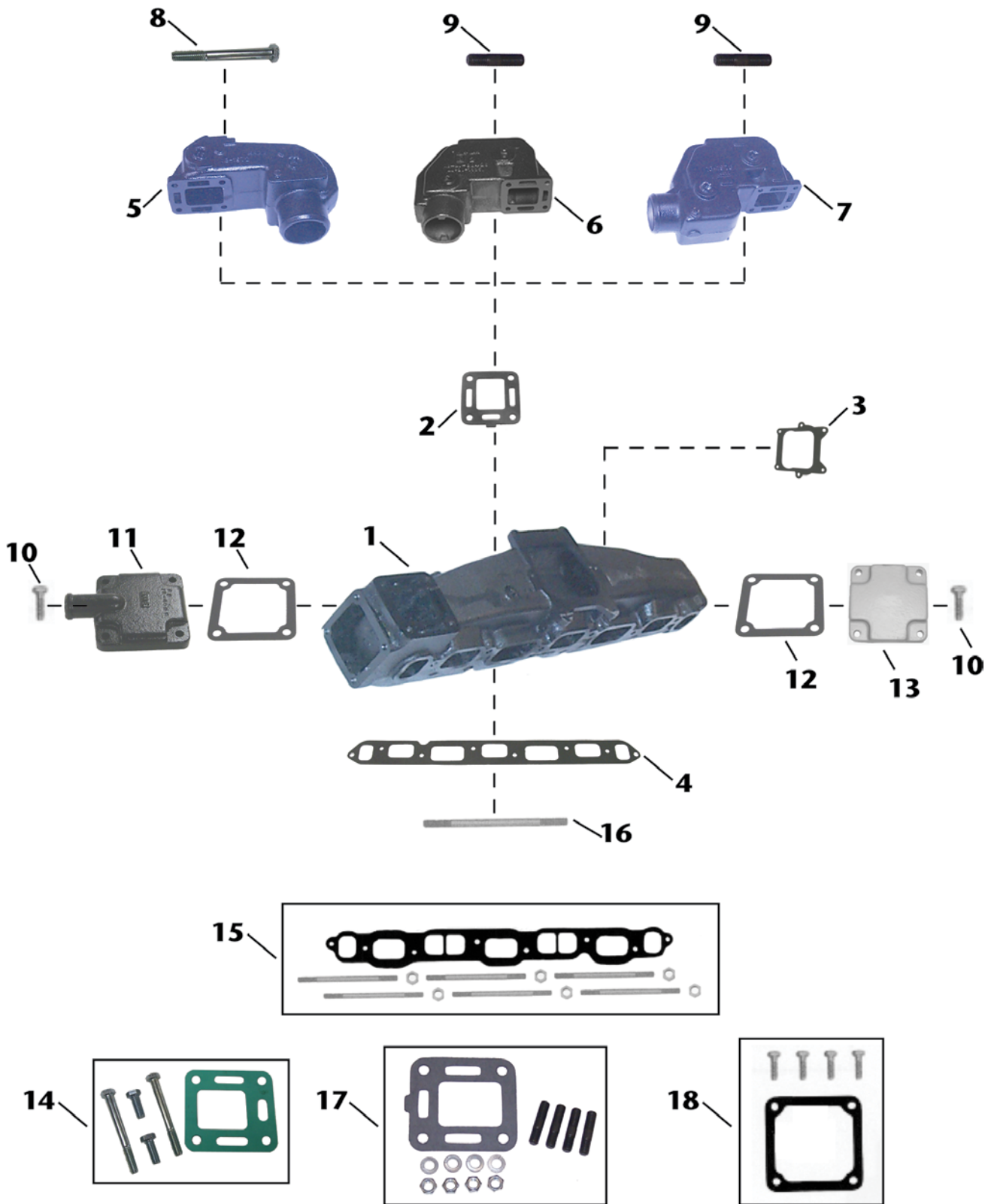

	Ref	Descripción	OE No.	Aplicación
1	18-1960-1	COLECTOR	58759A10	GM Seis cilindros en línea 250 & 292 cu.in. Modelos 165 & 200. Usar con junta colector 18-2830-1; Kit de montaje 18-8531.
2	18-2833	JUNTA CODO	27-99777-2	Usar con codos: 18-1971, 18-1978 & 18-1972. Incluye en 18-4362 Kit de montaje.
3	18-0353	JUNTA CARBURADOR	27-58764	Para colector: 18-1960-1
4	18-2830-1	JUNTA COLECTOR	27-46401	Para colector: 18-1960-1. Incluye en kit montaje 18-8531.
5	18-1972	CODO	76325A2	Usar con colector: 18-1960-1; Junta de codo 18-2833
6	18-1971	CODO	76351A2	Usar con colector: 18-1960-1; junta codo 18-2833; Kit de montaje 18-4362.
7	18-1978	CODO	76771A3	Usar con colector: 18-1960-1; junta codo 18-2833; Kit de montaje 18-4362.
8	NSS	TORNILLO	N/D	Incluido en tornillería de montaje 18-8552.
9	18-3233	TORNILLO	16-49545	3/8-24, 3/8-16 X 1 3/4. Incluido en 18-4362 kit de montaje.
10	NSS	TORNILLO	N/D	Incluido en 18-8512 kit de montaje.
11	18-4009	TAPA	60252A2	Para colector: 18-1960-1
12	18-2832-1	JUNTA	27-48043-1	Para babor y estribor: 18-1960-1. Incluido en kit de montaje 18-8512.
13	NSS	PLATINA	N/D	Para colector: 18-1960-1
14	18-8552	KIT TORNILLERIA	N/D	Incluye sólo tornillería para codo 18-1972.
15	18-8531	KIT DE MONTAJE	N/D	Usar con colector: 18-1960-1. Incluye junta colector 18-2830-1
16	NSS	TORNILLO	N/D	Incluido en 18-8531 kit de montaje.
17	18-4362	KIT DE MONTAJE	N/D	Usar con codos: 18-1971 & 18-1978. Incluye 18-2833 junta codos.
18	18-8512	KIT DE MONTAJE	N/D	Usar con tapa: 18-4009. Incluye junta 18-2832-1.



Fits GM V6 229 & 262 cu. in. Models 185 & 205

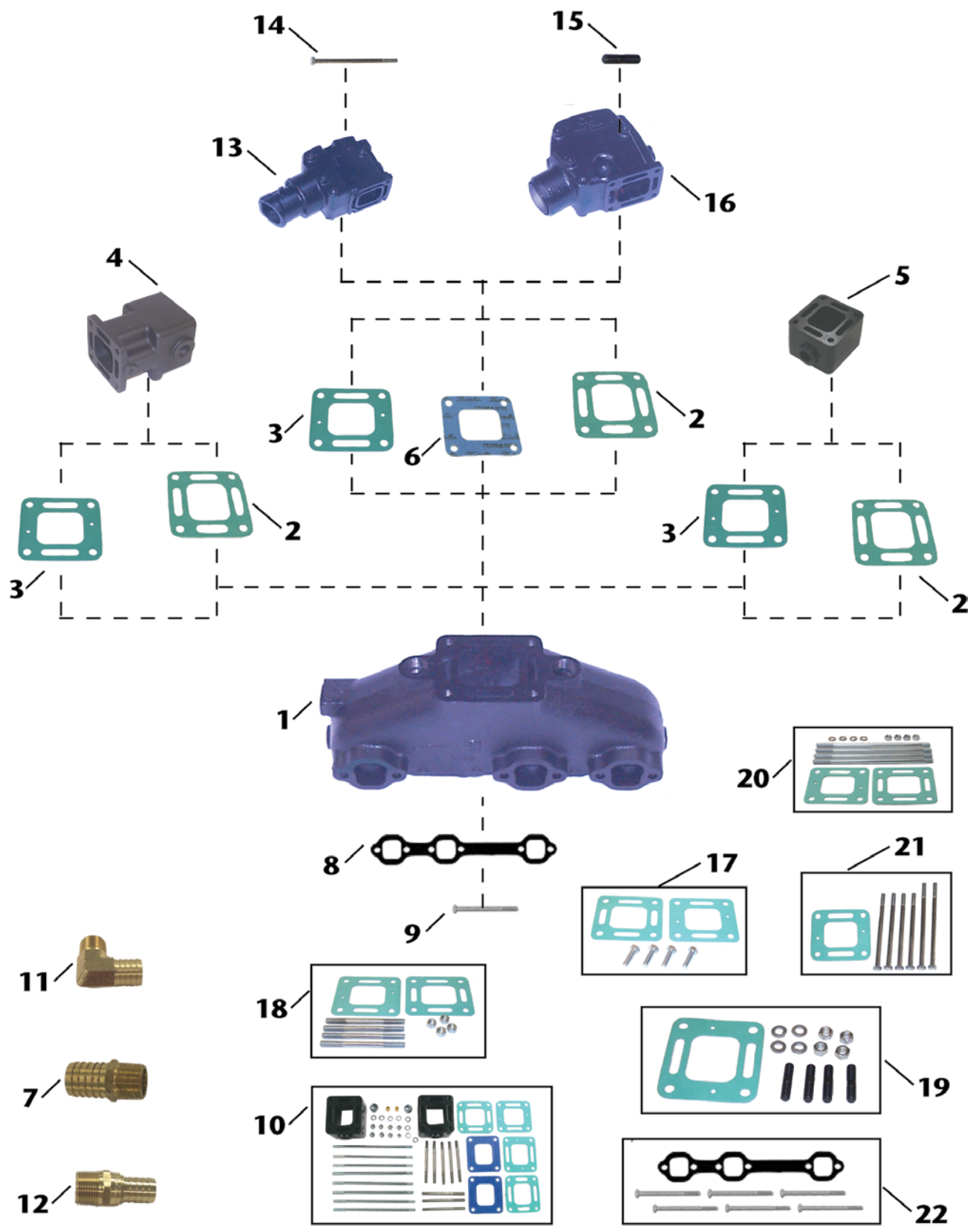

Ref	Descripción	OE No.	Aplicación
1	18-1952-1 COLECTOR	99746A8	GM (V6) 229 & 262 cu.in. Modelos 185 & 205 (babor & estribor). Usar con junta colector: 18-2909; kit montaje: 18-8533
2	18-2849-1 JUNTA CODO (abierto)	27-818832	Se ajusta a colector: 18-1952-1; espaciadores: 18-1985, & 18-1908; Codo: 18-1970-1, & 18-1976-2
3	18-0897 JUNTA CODO (RESTRICTOR)	27-41813	Para colector: 18-1952-1; espaciadores: 18-1985, & 18-1908; codos: 18-1970-1, & 18-1976-2
4	18-1985 ESPACIADOR	93322A12	6" Espaciador para colector: 18-1952-1. Usar con kit de montaje 18-8556. (Nota: para montar codos al espaciador es necesario kit separado)
5	18-1908 ESPACIADOR	933220	3" Espaciador para colectores: 18-1952-1. Usar con kit montaje 18-8555 con 18-1976-2, o kit de montaje 18-8554 con 18-1970-1.
6	18-0672 JUNTA CODO (BLOQUEADO)	27-860231	Para colector: 18-1952-1; codo: 18-1970-1, & 18-1976-2
7	18-4461 ENTRONQUE	N/D	3/4" - 14NPT X 1" manguera (Entronque de bronce resistente a la corrosión)
8	18-2909 JUNTA COLECTOR	N/D	Junta para colector: 18-1952-1. Incluido en kit montaje 18-8533.
9	NSS PERNO	N/D	Incluido en kit montaje 18-8533.
10	18-1908K KIT ESPACIADOR COLECTOR	807476A6, 93320A5	3" kit codo para colector: 18-1952-1. Incluye (2) espaciadores, restrictor, junta abierta y cerrada. Toda la tornillería necesaria para el montaje esta incluida.
11	18-8216 ENTRONQUE	N/D	3/4" - 14NPT X 1" manguera (Entronque de bronce resistente a la corrosión)
12	18-8215 ENTRONQUE	N/D	3/4" - 14NPT X 3/4" (enronque de bronce resistente a la corrosión)
13	18-1976-2 CODO COLECTOR 4" mang • 7° angulo.	44354A3, 807914A1	Para colector: 18-1952-1. Usar juntas codo: 18-2849-1, 18-0897, o 18-0672; Usar kit montaje: 18-8554
14	NSS TORNILLO	N/D	Incluido en kit de montaje 18-8505.
15	NSS TORNILLO	N/D	Incluido en kit de montaje 18-8529.
16	18-1970-1 CODO COLECTOR 3" mang • 0° angulo	98504A3	Para colector: 18-1952-1. Usar junta codo: 18-2849-1, 18-0897, or 18-0672; Usar kit de montaje: 18-8529, o si el espaciador esta incluido usar 18-8555.
17	18-8556 KIT DE MONTAJE	N/D	Usar con espaciador colector: 18-1985. Incluye (1) 18-2849-1 & 18-0897
18	18-8554 KIT DE MONTAJE	N/D	Usar con espaciador colector: 18-1908 con codo 18-1970-1. Incluido en 18-1908K. Incluye (1) junta codo 18-2849-1 & 18-0897.
19	18-8529 KIT DE MONTAJE	N/D	Usar con codo: 18-1970-1. Incluye junta codo 18-0897.
20	18-8555 KIT DE MONTAJE	N/D	Usar con espaciador colector: 18-1908 con codo 18-1976-2. Incluido en 18-1908K. Incluye (1) junta codo 18-2849-1 & 18-0897.
21	18-8505 KIT DE MONTAJE	N/D	Usar con codo: 18-1976-2. Incluye junta codo 18-0897.
22	18-8533 KIT DE MONTAJE	N/D	Usar con colector: 18-1952-1. Incluye junta colector 18-2909.

Fits GM Small Block V8 305-350 cu. in. Models 198, 228 & 898

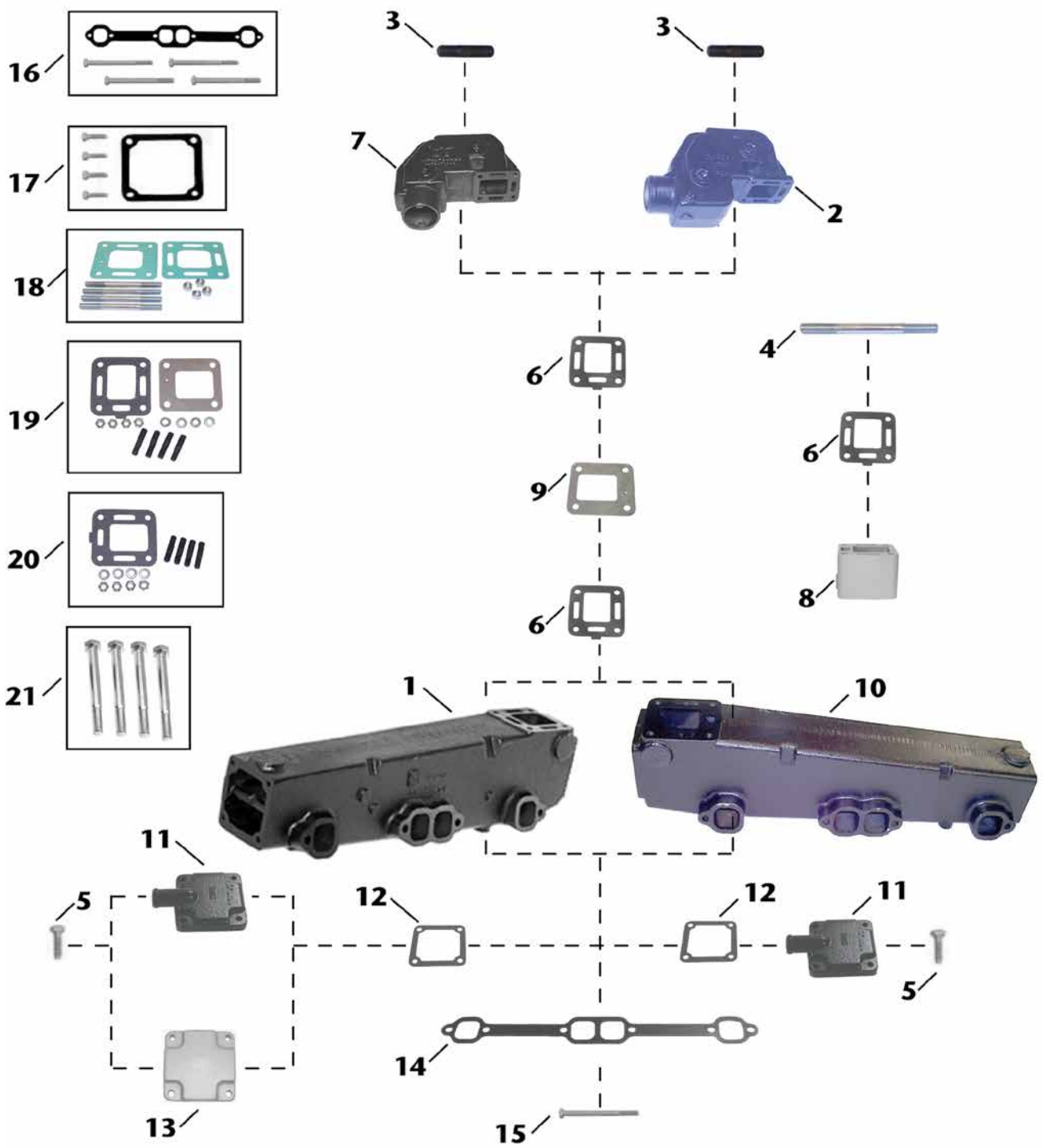

	Ref.	Descripción	OE No.	Aplicación
1	18-1951-1	COLECTOR (ESTRIBOR)	774235A2	GM bloque pequeño (V8) 305-350 cu.in. Modelos 198, 228, & 898. (estribor)
2	18-1978	CODO COLECTOR	76771A3	Usar con colectores: 18-1950-1, 18-1951-1; Junta con codo 18-2833; kit montaje 18-4362.
3	18-3233	TORNILLO	16-49545	3/8-24, 3/8-16 X 1 3/4. Incluido en 18-4362 kit montaje.
4	NSS	TORNILLO RAISER	N/D	Incluido en 18-8554 kit de montaje.
5	NSS	TORNILLO	N/D	Incluido en 18-8512 kit de montaje.
6	18-2833	JUNTA CODO	27-99777-2	Usar con codo: 18-1971 & 18-1978. Incluido en 18-4362 kit montaje.
7	18-1971	CODO COLECTOR	76351A2	Usar con colector: 18-1950-1, 18-1951-1; junta codo 18-2833; kit de montaje 18-4362.
8	18-1906	ESPACIADOR COLECTOR	61851	3" Espaciador colector: 18-1950-1, 18-1951-1. Usar con kit de montaje 18-8554 con codos 18-1971 o 18-1978.
9	18-4008	PLATINA	60207	Usar con colectores 18-1950-1, 18-1951-1. Requiere (2) junta codo 18-2833
10	18-1950-1	COLECTOR (BABOR)	77234A2	GM bloque pequeño (V8) 305-350 cu.in. Modelos 198, 228, & 898. (babor)
11	18-4009	TAPA LATERAL	60252A2	Usar con colectores (babor & estribor) : 18-1950-1 & 18-1951-1; kit de montaje: 18-8512
12	18-2832-1	JUNTA	27-48043-1	Para estribor y babor: 18-1950-1, 18-1951-1. Usar con platina: 18-4009. Incluido en kit de montaje 18-8512.
13	NSS	TAPA LATERAL	54870	Para colector: 18-1950-1, 18-1951-1; kit montaje: 18-8512.
14	18-2949	JUNTA COLECTOR	96306	Usar con colector: 18-1951-1
15	NSS	TORNILLO	N/D	Incluido en kit de montaje 18-8520.
16	18-8520	KIT DE MONTAJE	N/D	Usar con colector: 18-1950-1, 18-1951-1. Incluye junta colector 18-2949.
17	18-8512	KIT DE MONTAJE	N/D	Usar con tapas laterales: 18-4009. Incluye junta tapa lateral 18-2832-1
18	18-8554	KIT DE MONTAJE	N/D	Usar con espaciador: 18-1908 con Riser 18-1971 o 18-1978 codos. Incluida en 18-1908K. Incluye (1) junta codo 18-2849-1 & 18-0897
19	18-8514	KIT DE MONTAJE	N/D	Usar con codos: 18-1971 & 18-1978. Incluye junta 18-2833 & 18-4008 junta tapa.
20	18-4362	KIT DE MONTAJE	N/D	Usar con codos: 18-1971 & 18-1978. Incluye junta codo 18-2833.
21	18-8548	KIT TORNILLERÍA	N/D	Incluye sólo tornillería para colectores 18-1950-1 & 18-1951-1. Incluido en kit de montaje 18-8520.

Fits Ford Small Block V8 302-351 cu. in. Models 215, 225, 233, 255 & 888

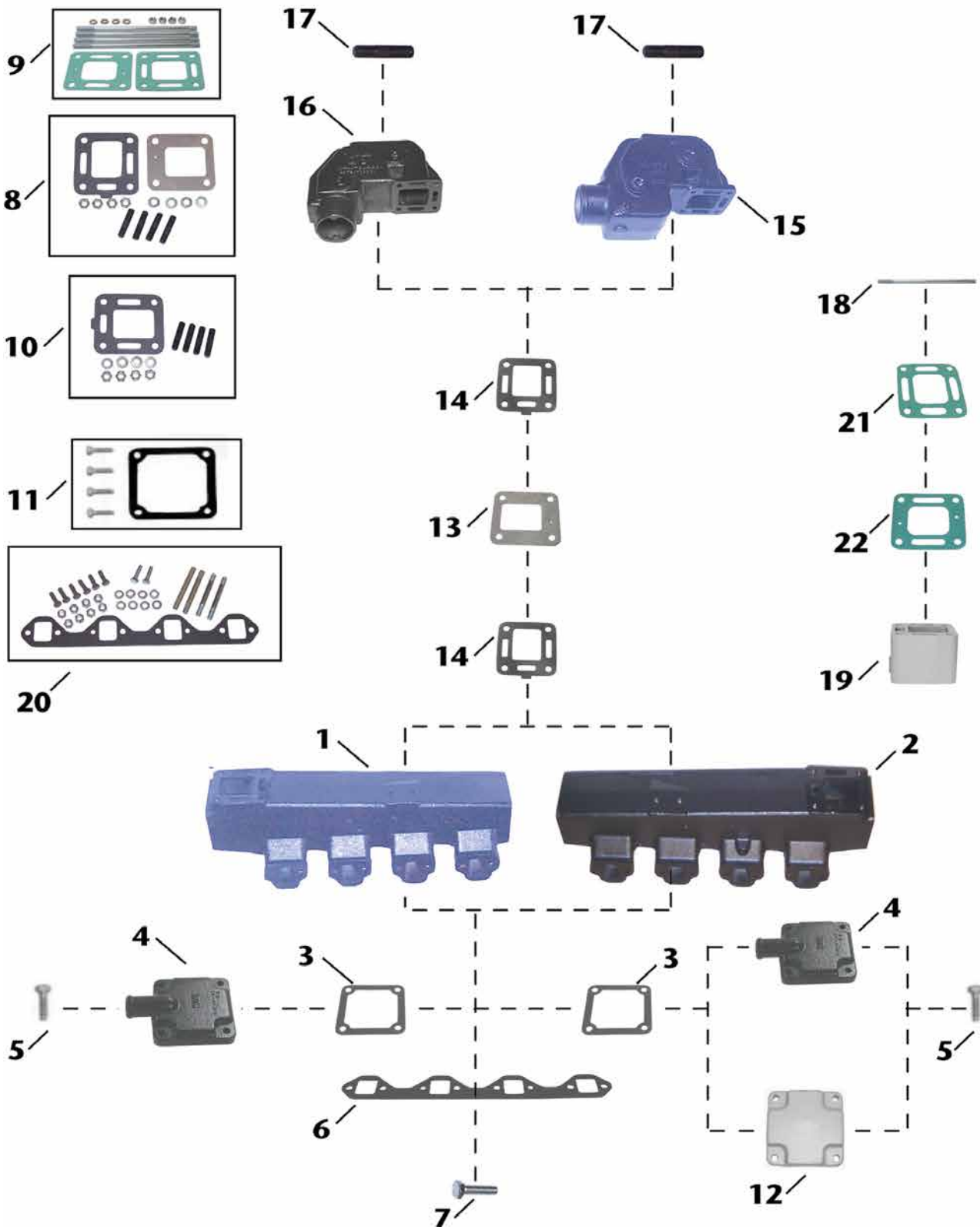

	Ref	Descripción	OE No.	Aplicación
1	18-1958-1	COLECTOR (BABOR)	65604A4	Bloque pequeño Ford (V8) 302-351 cu.in. Modelos 215, 225, 233, 255, & 888 (babor). Usar con junta colector: 18-0183-1; Kit de montaje 18-8509.
2	18-1962-1	COLECTOR (ESTRIBOR)	65603A4	Bloque pequeño Ford (V8) 302-351 cu.in. Modelos 215, 225, 233, 255, & 888 (estribor). Usar con junta colector: 18-0183-1; kit de montaje: 18-8509.
3	18-2832-1	JUNTA	27-48043-1	tapas colector para babor & estribor: 18-1958-1, 18-1962-1. Usar con tapa lateral: 18-4009. Incluido en el kit de montaje 18-8512.
4	18-4009	TAPA LATERAL	60252A2	Usar con colector (babor & estribor) : 18-1958-1, 18-1962-1; kit de montaje: 18-8512
5	NSS	TORNILLO	N/D	Incluido en kit de montaje 18-8512.
6	18-0183-1	JUNTA COLECTOR	27-73866	Usar con colector: 18-1958-1, 18-1962-1. Incluido en 18-8509 kit de montaje.
7	NSS	TORNILLO	N/D	Incluido en kit de montaje 18-8509.
8	18-8514	KIT DE MONTAJE	N/D	Usar con codos: 18-1971 & 18-1978. Incluye junta 18-2833 & junta codo 18-4008.
9	18-8554	KIT DE MONTAJE	N/D	Usar con espaciador: 18-1906 con codo 18-1971 o 18-1978. Incluye (1) 18-2849-1 & junta codo 18-0897.
10	18-4362	KIT DE MONTAJE	N/D	Usar con codos: 18-1971 & 18-1978. Incluye junta codo 18-2833.
11	18-8512	KIT DE MONTAJE	N/D	Usar con tapa lateral: 18-4009. Incluye junta 18-2832-1.
12	NSS	TAPA LATERAL	54870	Para colector: 18-1958-1, 18-1962-1; kit de montaje: 18-8512.
13	18-4008	JUNTA TAPA	60207	Usar con colector 18-1958-1, 18-1962-1. Requiere (2) juntas codo 18-2833.
14	18-2833	JUNTA CODO	27-99777-2	Usar con codos: 18-1971 & 18-1978. Incluido en kit de montaje 18-4362.
15	18-1978	CODO COLECTOR	76771A3	Usar con colector: 18-1958-1, 18-1962-1; junta codo 18-2833; kit de montaje 18-4362.
16	18-1971	CODO COLECTOR	76351A2	Usar con colectores: 18-1958-1, 18-1962-1; junta codo 18-2833; kit de montaje 18-4362.
17	18-3233	TORNILLO DE MONTAJE	16-49545	3/8-24, 3/8-16 X 1 3/4. Incluido en kit de montaje 18-4362.
18	NSS	TORNILLO DE MONTAJE	N/D	Incluido en kit de montaje 18-8554.
19	18-1906	ESPACIADOR COLECTOR	61851	3" Espaciador para colectores: 18-1950-1, 18-1951-1. Usar con kit de montaje 18-8554 con 18-1971 o codo 18-1978.
20	18-8509	KIT DE MONTAJE	N/D	Usar con colectores: 18-1958-1, 18-1962-1. Incluye junta colector 18-0183-1
21	18-2849-1	JUNTA CODO (ABIERTO)	27-818832	Para colector: 18-1958-1, 18-1962-1; espaciador colector: 18-1985. Incluye en kit de montaje 18-8554.
22	18-0897	JUNTA CODO (RESTRICTOR)	27-41813	Para colector: 18-1958-1, 18-1962-1; Espaciador colector: 18-1985. Incluido en kit de montaje 18-8554.

Fits GM 4 Cylinder 181 cu. in. Models 120, 140, 2.5L & 3.0L

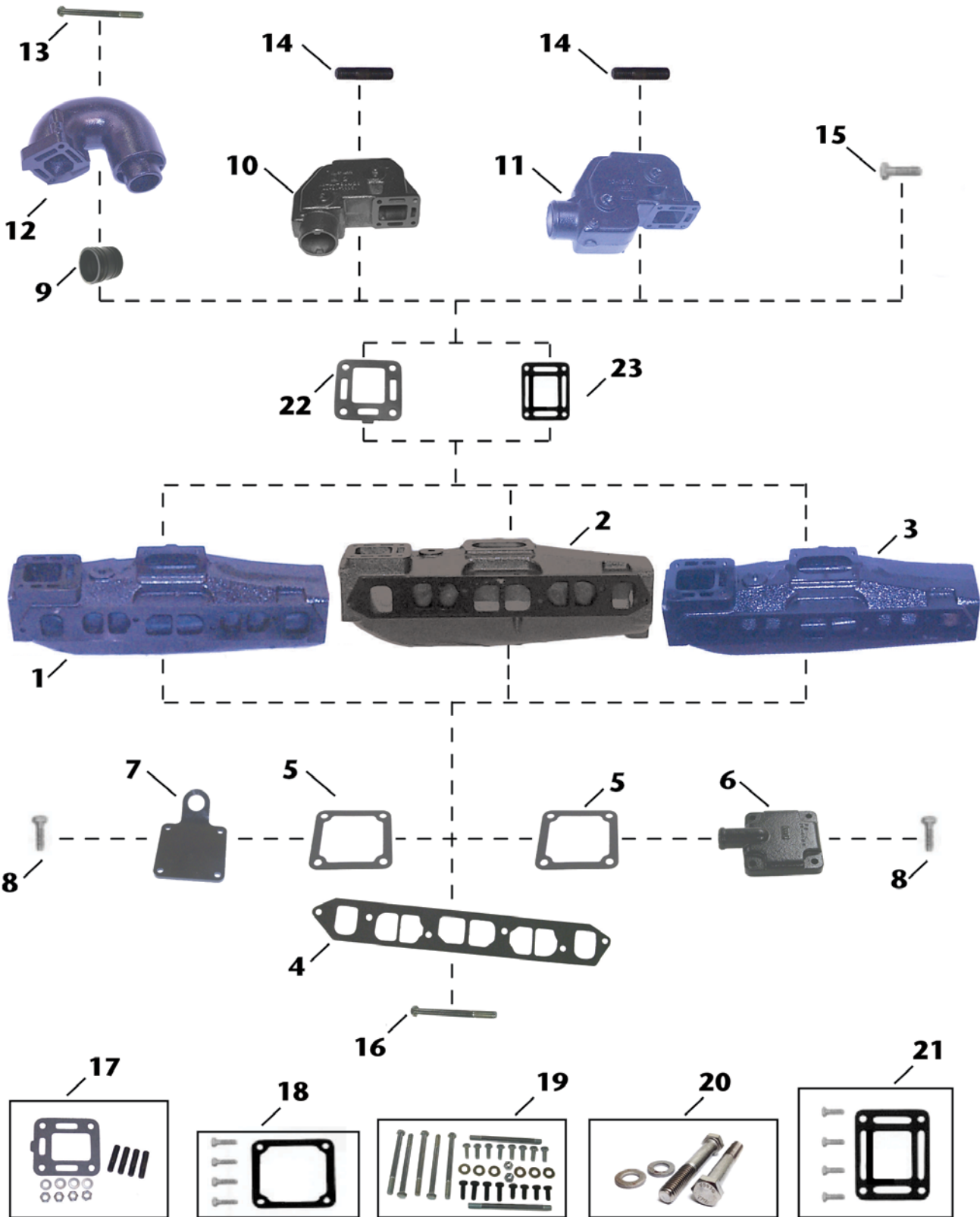

	Ref	Descripción	OE No.	Aplicación
1	18-1954-1	COLECTOR	9582A5	Para 2.5 & 3.0L 181 CID, Modelo 140 con carburador Rochester con starter eléctrico (1983-89). Usar con junta colector: 18-1204-1.
2	18-1955-1	COLECTOR	96705A1	Para 3.0L 181 CID, Modelo 140 con carburador Rochester con starter mecánico (1968-82). Usar con junta colector: 18-1204-1. montaje tornillería: 18-8549.
3	18-1956-2	COLECTOR	99798A18	Para 3.0L 181 CID, Modelo 140 & 3.0 con carb mercarb con starter eléctrico (1983-95). Usar con junta colector: 18-1204-1.
4	18-1204-1	JUNTA COLECTOR	27-96429	Para colector: 18-1954-1, 18-1955-1, 18-1956-2
5	18-2832-1	JUNTA	27-48043-1	Para babor & estribor tapas colector: 18-1954-1, 18-1955-1, 18-1956-2.
6	18-4009	TAPA LATERAL	60252A2	Para colector: 18-1954-1, 18-1955-1, 18-1956-2
7	18-5021	TAPA LATERAL	805629	Para colector: 18-1954-1, 18-1955-1, 18-1956-2
8	NSS	TORNILLO	N/D	Incluido en kit de montaje 18-8512 .
9	18-2748	UNION MANGUITO	32-44348T	4" Diámetro interior. Usar con codo 18-1975-1.
10	18-1971	CODO COLECTOR	76351A2	Usar con colector: 18-1954-1, 18-1955-1, 18-1956-2; junta colector 18-2833; kit montaje 18-4362
11	18-1978	CODO COLECTOR	76771A3	Usar con colector: 18-1954-1, 18-1955-1, 18-1956-2; junta codo 18-2833; Kit montaje 18-4362
12	18-1975-1	CODO COLECTOR	12076A2	Usar con colector: 18-1954-1, 18-1955-1, 18-1956-2; junta codo 18-2819-1; kit de montaje 18-8551: Manguito de escape 18-2748
13	NSS	TORNILLO	N/D	Incluido en kit de montaje 18-8551.
14	18-3233	TORNILLO	N/D	3/8-24, 3/8-16 X 1 3/4. Incluido en kit de montaje 18-4362.
15	NSS	TORNILLO	N/D	Incluido en kit de montaje 18-8508.
16	NSS	TORNILLO	N/D	Incluido en kit de montaje 18-8549.
17	18-4362	KIT DE MONTAJE	N/D	Usar con codos: 18-1971 & 18-1978. Incluye junta codo 18-2833.
18	18-8512	KIT DE MONTAJE	N/D	Usar con tapa lateral: 18-4009 & tapa lateral (NSS). Incluye junta tapa lateral 18-2832-1.
19	18-8549	KIT DE MONTAJE	N/D	Incluye sólo tornillería para colector 18-1955-1.
20	18-8551	KIT DE MONTAJE	N/D	Incluye sólo tornillería para codo 18-1975-1.
21	18-8508	KIT DE MONTAJE	N/D	Usar con codo 18-1973. Incluye junta codo 18-2819-1.
22	18-2833	JUNTA CODO	27-99777-2	Usar con codos: 18-1971 & 18-1978. Incluido en kit de montaje 18-4362
23	18-2819-1	JUNTA CODO	27-39915	Usar con codos: 18-1973. Incluido en kit de montaje 18-8508.

Fits GM Small Block V8 305 & 350 cu. in. Models 200, 228, 230, 260 & 898

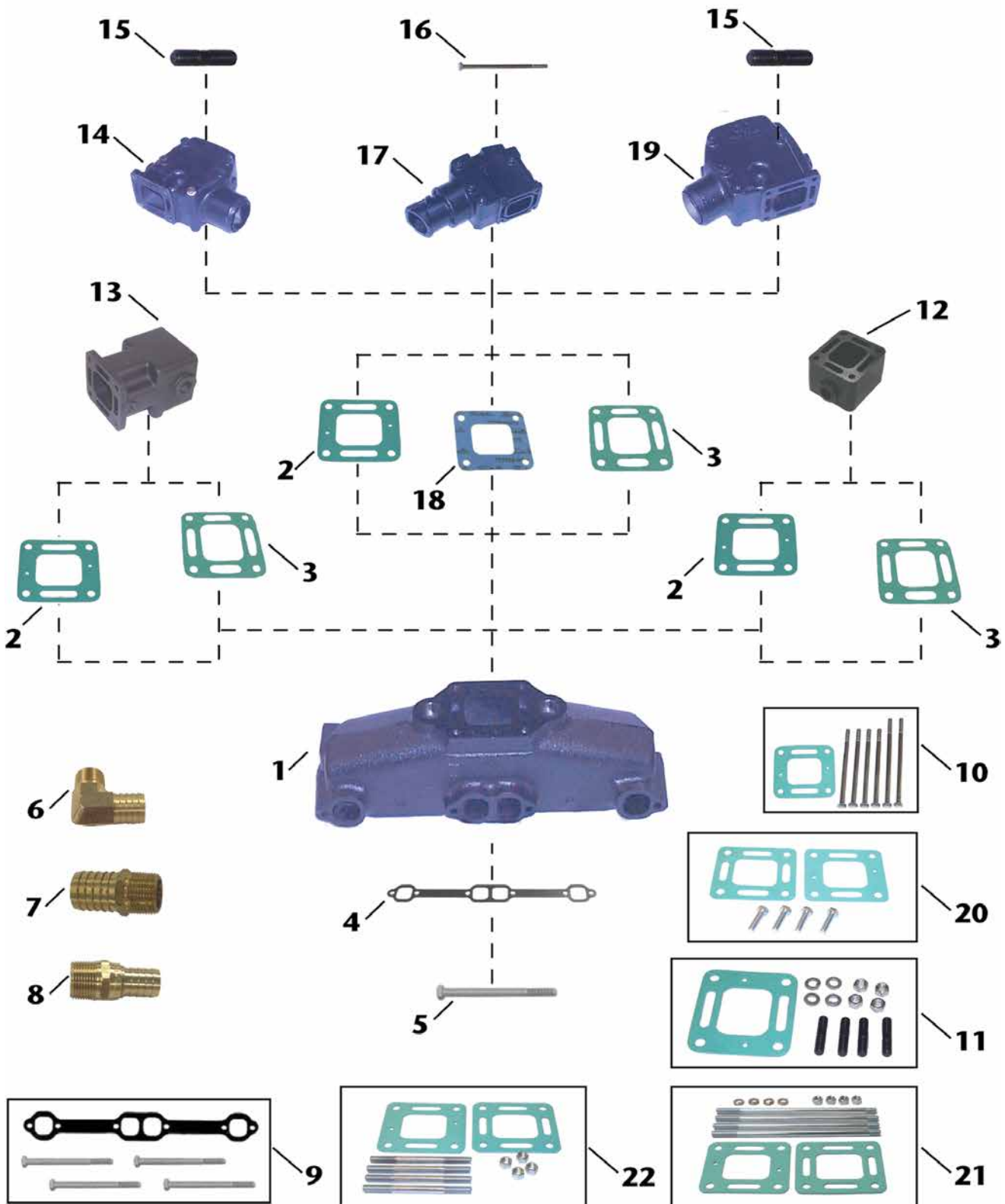

	Ref	Descripción	OE No.	Aplicación
1	18-1953-2	COLECTOR	87114A19	Bloque pequeño GM (V8) 305-350 cu.in. Modelos 200, 228, 230, 260, & 898
2	18-0897	JUNTA CODO (RESTRICTOR)	27-41813	Para colector: 18-1953-2; Espaciador colector: 18-1985, & 18-1908; Codo: 18-1970-1, 18-1976-2, 18-1974-1
3	18-2849-1	CODO JUNTA (ABIERTO)	27-818832	Para colector: 18-1953-2; Espaciador colector: 18-1985, & 18-1908; Codo: 18-1970-1, 18-1976-2, 18-1974-1
4	18-2949	JUNTA COLECTOR	96306	Usar con colector: 18-1953-2. Incluido en kit montaje 18-8520.
5	NSS	TORNILLO	N/D	Incluido en kit montaje 18-8520.
6	18-8216	ENTRONQUE	22-36305	3/4" - 14NPT X 1" Entronque de bronce resistente a la corrosión
7	18-4461	ENTRONQUE	N/D	3/4" - 14NPT X 1" Entronque de bronce resistente a la corrosión
8	18-8215	ENTRONQUE	N/D	3/4" - 14NPT X 3/4" Entronque de bronce resistente a la corrosión
9	18-8520	KIT DE MONTAJE	N/D	Usar con colector: 18-1953-2. Incluye junta colector 18-2949.
10	18-8505	KIT DE MONTAJE	N/D	Usar con codo: 18-1976-2. Incluye junta codo 18-0897.
11	18-8529	KIT DE MONTAJE	N/D	Usar con codo: 18-1970-1, 18-1974-1. Incluye juntas codo 18-0897.
12	18-1908	ESPACIADOR COLECTOR	933220A12	3" Espaciador colector: 18-1953-2. Usar con kit de montaje 18-8554 con 18-1970-1, o kit de montaje 18-8555 con 18-1976-2.
13	18-1985	ESPACIADOR COLECTOR	93322	6" Espaciador colector: 18-1953-2. Usar con kit de montaje 18-8556. (Nota: para montar codos al espaciador es necesario un kit separado)
14	18-1974-1	CODO COLECTOR 3" mang • 0° angulo	98502A2	Para colector: 18-1953-2. Usar junta codo: 18-2849-1, 18-0897, o 18-0672; Usar kit montaje: 18-8529. (No usar con espaciador)
15	NSS	TORNILLO	N/D	Incluido en kit montaje 18-8529.
16	NSS	TORNILLO	N/D	Incluido en kit de montaje 18-8505.
17	18-1976-2	CODO COLECTOR 4" mang • 7° angulo	44354A3, 807914A1	Para colector: 18-1953-2. Usar junta codo: 18-2849-1, 18-0897, o 18-0672; Usar kit de montaje: 18-8505, si el espaciador está incluido 18-8555.
18	18-0672	JUNTA CODO (CERRADA)	27-860231	Para colector: 18-1953-2; espaciador colector: 18-1985, & 18-1908; Codo: 18-1970-1, 18-1976-2, 18-1974-1
19	18-1970-1	CODO COLECTOR 3" mang • 15° angulo	98504A3	Para colector: 18-1953-2. Usar junta codo: 18-2849-1, 18-0897, o 18-0672; Usar kit montaje: 18-8529, si el espaciador esta incluido 18-8554.
20	18-8556	KIT DE MONTAJE	N/D	Usar con espaciador colector: 18-1985. Incluye 18-0897 & 18-2849-1. (Nota: para montar codos al espaciador es necesario un kit separador)
21	18-8555	KIT DE MONTAJE	N/D	Usar con kit de codos 18-1908K: espaciador 18-1908: codo 18-1976-2: Colector: 18-1953-1
22	18-8554	KIT DE MONTAJE	N/D	Usar con kit codos 18-1908K: espaciador 18-1908: codo 18-1970-1: colector: 18-1952-1

COLECTORES SIERRA

ESTÁN PINTADOS, INCLUYEN KIT DE JUNTAS & VERIFICADOS CONTRA FUGAS

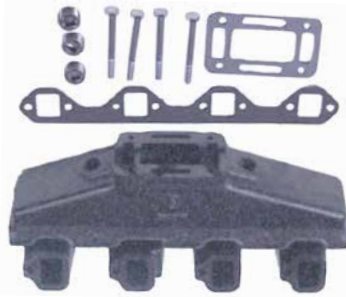

18-1998-1
COLECTOR ESCAPE
 Babor & estribor
 Reemplaza: Barr FM-1-83
 Codo colector centrado
 Para: Motores Ford 302 y 351 CID
 Incluye kit de montaje 18-4363
 Usar con:

Juego de juntas colector escape: 18-0603
 *Para el despiece - Ver páginas 628-629



18-1997-1
COLECTOR ESCAPE
 Babor & estribor
 Reemplaza: Barr CHV-1-83 Codo colector centrado
 Para: motores GM 283, 305, 307 y 350 CID
 Usar con:

Juego de juntas colector escape: 18-0604
 *Para despiece - Ver páginas 626-627



18-1898
COLECTOR
 Babor & estribor
 Reemplaza: Barr CHVA-1-84, Marine Power 0991-110
 Para 454 cu. in. motores GM bloque grande V8
 Usar con:

Junta colector escape: 18-0418
 Codo: 18-1939, 18-1999
 *Para despiece - Ver Páginas 624-625



18-1951-1*
COLECTOR
 Suministrado con kit de montaje
 Reemplaza: 77235A2, 77235A8
 ESTRIBOR
 Para mayoría de bloques Mercruiser pequeños (GM)
 Usar con:

Junta colector escape: 18-2949
 Kit montaje: 18-8548



18-1950-1*
COLECTOR
 Suministrado con kit montaje
 Reemplaza: 77234A2, 77234A7
 BABOR
 Para mayoría de bloques Mercruiser pequeños(GM)
 Usar con:

Juntas colector escape: 18-2949
 kit montaje: 18-8548



18-1952-1*
COLECTOR
 Babor & estribor
 Reemplaza: Mercruiser 99746A8, A17
 Marine Power 611447
 Para mayoría de motores 4.3L (262 CID) V-6
 Suministrado con kit de montaje
 Usar con:

Kit montaje: 18-8533



18-1953-2
COLECTOR
 Babor & Estribor
 Suministrado con kit de montaje
 Reemplaza: Mercruiser 87114A19, 86024A10, 860246A15, 860246A3, 860246A7, 860246A9, 860336A2, 860337A2, 87114A19, 87114A30
 Marine Power 0994-100
 Para mayoría de bloques pequeños Mercruiser(GM) con codo central
 Suministrado con juntas
 Usar con: Kit de montaje: 18-8520



18-1954-1*
COLECTOR
 Suministrado con kit de montaje
 Reemplaza: Mercruiser 95862A5
 Marine Power 0993-000
 Para mayoría de últimos modelos 2.5L 153 CID & 3.0L 181 CID con carburador Rochester 5 TORNILLOS (1983-89)
 Usar con:
 Junta colector escape: 18-1204-1
 Tapa lateral: 18-4009

* PARA MODELOS ESPECÍFICOS VER APLICACIÓN EN PÁGINAS 473-476



18-1958-1*
COLECTOR

Reemplaza: 65604A4, A12 LADO BABOR

Para mayoría de bloques pequeños Mercruiser (Ford) V-8

Suministrado con kit montaje

Usar con:

Kit montaje: 18-8509



18-1955-1*
COLECTOR
Nuevo tipo

Suministrado con kit montaje

Reemplaza: 96705A1

Para mayoría de Modelos 3.0L 181 CID con carburador Rochester
5 TORNILLOS y 2.5L, 153CID (1968-82)

Usar con:

Junta colector escape: 18-1203

Tapa lateral: 18-4009



18-1956-2
COLECTOR

Suministrado con kit de montaje

Reemplaza: Mercruiser 860235A04, 99798A3, 99798A9, 99798A16,
99798A18, 806867A8

Marine Power 600333

Para 2.5 & 3.0L (1983-89)



18-1957-1*
COLECTOR

Babor & Estribor

Reemplaza: Mercruiser 89011A8,
807078A6

Marine Power 0991-1000

Para mayoría bloques grandes Mercruiser (GM) V-8

Usar con:

Colector escape: 18-0418

Kit de montaje: 18-8532



18-1960-1*
COLECTOR

Reemplaza: 58759A10, A14

Para mayoría Mercruiser (GM) en línea 6 Cil.

Suministrado con kit de montaje

Usar con:

Kit de montaje: 18-8531



18-1962-1*
COLECTOR

Estribor

Reemplaza: 65603A4, 65603A12

Para mayoría de bloques pequeños Mercruiser (Ford)
V-8

Suministrado con kit de montaje

Usar con:

kit de montaje: 18-8509

18-1987-1
KIT DE CONVERSIÓN
DE COLECTOR ESCAPE

No se puede usar en motores con bomba
de dirección en montaje superior

KIT INCLUYE:

- 2 Colectores
- 2 Codos escape
- 1 Alojamiento termostato
- 1 Tapa termostato
- 1 Termostato

Todas las mangueras, juntas, etc se acompañan de instrucciones para el correcto montaje!!



Este kit de colector está diseñado para convertir todas las direcciones de motores Mercruiser con bloques GM 305 y 350 CID en los más modernos y eficientes colectores centrales.



18-1966
COLECTOR
 Reemplaza: 806867A2, 806867A3, 806867A8, 806867A9, 806867A12, 816329A3, 860235A03, 99798A18
 Para: 3.0L/LX (1990 & post); Motores Marine Power Model E181S



18-1843
COLECTOR ESCAPE
 Reemplaza: 865735A02, 865049T01, 864308T01
 Para: 305, 350, 377, 5.0L, 5.7L, 6.2L(2002 y post)
 Usar con:
 Junta colector: 18-2949
 Junta codo: 18-0720, 18-0721 o 18-0722
 Codo: 18-1845



18-1999
CODO
 Reemplaza: Barr 20-0082
 Para: 3" D.I. manguera escape.
 Suministra con kit de montaje abierto 18-4364
 Usar con:
 Colector: 18-1997-1 o 18-1998-1 o 18-1898
 Junta codo: 18-2854-1 abierto o 18-0476-1 cerrado
 kit de montaje: 18-4364 abierto o 18-8535 cerrado



18-1970-1*
CODO
 Reemplaza: Mercruiser 98504A3, 98503A2, 95755A2
 Marine Power 0992-115
 Para V-6 & V-8 aplicaciones, 15° (Codo 3" D.E) Suministrado con 18-0897 y tapones de bronce
 Usar con:
 Colector: 18-1952-1, 18-1953-2, 18-1957-1
 Junta codo: 18-0897 restrictor, 18-2849-1 abierto, 18-0672 cerrado
 kit de montaje: 18-8529



18-1971*
CODO
 Reemplaza: Mercruiser 76351A2, 76351A1, 76351A04, 60426A1, 49964A1, 49964A2
 Marine Power 0993-001
 Para primeros modelos mercruiser Mercruiser 140 HP (4 cil) aplicaciones
 Reemplaza: Barr MC20-60426P
 Usar con:
 Colector: 18-1960-1, 18-1958-1, 18-1950-1
 Junta codo: 18-2833
 kit de montaje: 18-4362



18-1992-1
ADAPTADOR ESCAPE
 Para 3" D.I. manguera escape
 (Como usado en kit conversión colector escape 18-1987) 80°



18-1972*
CODO
 Reemplaza: 76325A2
 Para últimos modelos 120, 140 HP aplicaciones Mercruiser
 Usar con:
 Colector: 18-1955-1, 18-1954-1, 18-1956-2, 18-1901
 Junta codo: 18-2833
 Kit montaje: 18-8552



18-1973*
CODO
 Reemplaza: 39920, 39920A1, 55538A2
 Para mayoría de primeros modelos 120 HP Aplic. Mercruiser aplicaciones



18-1991
CODO ADAPTADOR
 Para uso con manguera escape 3" D.I.
 Usar con:
 Codo colector: 18-1999
 30°



18-1978
CODO
 Reemplaza: 76771A3, A2
 V-8 Sólo aplicaciones intraborda
 Usar con:
 Colector: 18-1950-1, 18-1951-1, 18-1958-1, 18-1962-1
 Junta codo: 18-2833
 Kit de montaje: 18-4362



18-1905
CODO
 Reemplaza: 90880
 Mercruiser 4 Cilindro 224cu. in. 3.7L (Modelos: 165, 170, 180, 190).
 Usar con:
 Colector: Mercruiser 99908
 Junta montaje codo escape: 18-0113-1
 Kit de montaje: 18-8500

* PARA MODELOS ESPECÍFICOS VER APLICACIÓN EN PÁGINAS 473-476



18-1937
CODO
 Reemplaza: 98562A6
 Mercuriser 4 Cilindro 224cu. in. 3.7L (Modelos: 165, 170, 180, 190).
 Usar con:
 Junta montaje codo escape: 18-0881-1
 Kit montaje: 18-8530



18-1974-1*
CODO
 Reemplaza: 98502A2
 Para aplicaciones V-6 & V-8 0° (Codo 3" D.E.)
 Suministrado con junta 18-0897 y tapón bronce



18-1976-2*
CODO
 Reemplaza: Mercuriser 44354A3, 44354A9, 44354A10, 44354A13, 807914A1, 807988A2, 807988A03
 Marine Power 0992-400
 Para mayoría de aplicaciones Mercuriser V-6 & V-8 7° (Codo 4" D.E.) suministrado con 18-0897, 18-4263 & 18-4258
 Usar con:
 Colector: 18-1952-1, 18-1953-2, 18-1957-1
 Junta codo: 18-0897 restrictor, 18-2849-1 abierto, 18-0672 cerrado
 Kit montaje: 18-8505



18-1845
CODO ESCAPE
 Reemplaza: 864591T02
 Para: 2004 & sup V6 & V8(305, 350, 377) SN 0W310000 & sup, 2002 & sup V8(350 & 377) SN 0M317000 & sup
 Usar con:
 colector: 18-1843
 Juntas codo: 18-0720, 18-0721 o 18-0722



18-1907
CODO
 Reemplaza: Barr 20-0102, Indmar 53-2009 y 53-2018
 Barr, Indmar Ford bloques pequeños V8 302-351cu. in. •
 Usar con 3" manguera.
 Usar con:
 Colector: 18-1997-1, 18-1998-1
 Junta codo: 18-2854-1 abierto o 18-0476-1 cerrado
 Kit de montaje:
 18-4364 abierto o 18-8535 cerrado



18-1939
CODO
 Reemplaza: Barr 20-0100, Marine Power 0992-593 Barr, Indmar y Marine Power Ford bloques pequeños V8 302-351cu. in. GM bloques pequeños V8 305-350cu. in., GM bloque grande V8 454cu. in. • Usar con 3 1/2" mang.
 Usar con:
 Colector: 18-1997-1, 18-1998-1, 18-1898
 Junta codo: 18-2854-1 abierto ó 18-0476-1 cerrado
 Kit de montaje:
 18-4364 abierto o 18-8535 cerrado



18-1975-1*
CODO
 Reemplaza: Mercuriser 12076A1, 12076A2, 95864A2
 Marine Power 6000-33A
 Para último modelo Mercuriser 4 cil.
 Usar con:
 Colector: 18-1955-1, 18-1954-1, 18-1956-2, 18-1901
 Junta codo: 18-2833
 Kit de montaje: 18-8551
 Manguito: 18-2748



18-1908K
KIT ESP.COLECTOR/CODO
 Reemplaza: 807476A6, 93320A2, 93320A3, 93320A5, 93320A6, 93320A13
 Alpha/Bravo/Gen+/GenIV GM bloque pequeño V-8 305, 350, 4.3L, 454, 5.0, 5.7L, 502, 7.4L, 8.2L, (3" kit Riser)
 Completo con tornillería de montaje. Codo central 3"
 Usar con:
 Colector: 18-1952-1, 18-1953-2, 18-1957-1 3"



18-1906
ESPACIADOR ESCAPE
 Reemplaza: 61851A1
 3" espaciador para 18-1950, 18-1951, 18-1958-1 & 18-1962-1 escapes



18-1908
ESPACIADOR CODO COLECTOR - 3"
 Reemplaza: 93320
 Mercuriser GM V6 229 y 262cu.in. (Modelos: 185 and 205), bloques pequeños GM V8 305-350cu.in. (Modelos: 200, 228, 230, 260 y 898), bloque grande GM V8 454cu.in. (Modelos: 330, 340 y 7.4L)
 Usar con:
 Colector: 18-1952-1, 18-1953-2, 18-1957-1



18-1985
ESPACIADOR COLECTOR - 6"
 Reemplaza: Mercuriser 93322 Marine Power 612011
 Para: 229 y 262 V6, 305-350 bloq. pequeño V8, 454 Bloque grande V8
 Usar con:
 Colector: 18-1952-1, 18-1957-1, 18-1953-2



18-1949
ESPACIADOR COLECTOR
 Espaciador 3" para Barr, Indmar y Marine Power Ford bloque pequeño V8 302-351cu.in., GM bloque pequeño V8 305-350cu.in., GM bloque grande V8 454cu.in.
 Usar con:
 Colector: 18-1998-1, 18-1997-1 y 18-1898



18-1990
JUNTA TAPA ESCAPE
 Reemplaza: 48045, 54870, 73813, 73813A1, 73813F1



18-5021
JUNTA TAPA ESCAPE
 Reemplaza: Mercruiser 805629
 Usar con:
 Colector: 18-1954-1, 18-1955-1, 18-1956-2



18-1995
TAPA COLECTOR
 Reemplaza: 47638, 47638A1
 GM 4 cil. 153 cu. in. Para modelo 110/120 acopla carb. parte posterior motor



18-4008
JUNTA TAPA ESCAPE
 Reemplaza: 60207
 Usar con:
 Codo: 18-1971, 18-1978



18-4009
TAPA LATERAL COLECTOR
 Reemplaza: 52999, 60252, 60252A2
 Usar con:
 Colector: 18-1960-1, 18-1958-1, 18-1950-1, 18-1951-1
 Junta tapa lateral: 18-2832-1
 Kit de montaje: 18-8512

TAPONES



Ref. #	Reemplaza	Tamaño rosca	Descripción
18-4257	—	1/4"	Tapón acero negro
18-4263	22-32802, 22-328022, 22-328021, 22-841908, 22-30139, F700633, F15810151,	1/8" - 27 NPT	Tapones
18-4264	22-32803, 22-87543, F15880010	3/8" - 18 NPT	Tapones
18-4265	22-428611, 22-42861, 22-861187	3/4" - 14 NPT	Tapones (bronce hexagonal)
18-8111 ①	22-36392	1/4" - 18 NPT	Tapones
18-4258	22-33198A1, 22-41622	3/4" - 14 NPT	Tapones (Acero inox cuadrado)

TORNILLOS RISE

Ref #	Reemplaza	Tamaño Rosca	Descripción
18-8410	10-43749	3/8"-16 x 5 3/4"	Usar sin filtro Aceite remoto
18-8411	10-44387	3/8"-16 x 6 3/4"	Usar sin filtro Aceite remoto



18-4362
KIT DE MONTAJE CODO ESCAPE
 Reemplaza: Barr MC20-60426P
 Usar con:
 Codo: 18-1971



18-4363
KIT DE MONTAJE CODO ESCAPE
 Reemplaza: Barr FM-1-83-P
 Usar con:
 Colector: 18-1998-1



18-4364 (Abierto)
KIT MONTAJE CODO ESCAPE
 Reemplaza:
 Barr 20-0082-P
 Usar con:
 Codo: 18-1999, 18-1907, 18-1939

56507 Selladora de Teflono[®] recomendada para las estrías de la rosca



18-8500
KIT DE MONTAJE CODO ESCAPE
 Mercruiser 4 Cilindro 224cu.in. 3.7L (Modelos: 165, 170, 180, 190)
 Usar con:
 Codo/Depósito: 18-1905



18-8505
KIT DE MONTAJE CODO ESCAPE
 Mercruiser GM V6 229 y 262cu.in. (Modelos 185 y 205), bloques pequeños GM V8 305-350cu.in. (Modelos: 200, 228, 230, 260, 898), GM Bloque grande V8 454cu.in. (Modelos: 330, 340 y 7.4L)
 Usar con:
 Codo: 18-1976-2



18-8508
KIT DE MONTAJE COLECTOR ESCAPE
 Mercruiser GM 4 Cilindro 153cu.in. (Primeros modelos 110/120), GM En línea Cilindro 250cu.in.(Modelo: 160)
 Usar con:
 Codo: 18-1973

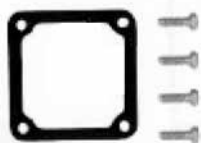

18-8512
KIT DE MONTAJE CODO ESCAPE
 Mercruiser GM 4 Cilindro 181cu.in. (Modelos: 120,140, 2.5L,3.0L), GM En línea 6 Cilindro 250-292cu.in. (Modelos: 165 y 200), bloques pequeños Ford V8 302-351cu.in. (Modelos: 215,225,233, 255,888), bloques pequeños GM V8 305, 350cu.in.(Modelos: 198,228,898)
 Usar con:
 Tapa lateral: 18-4009

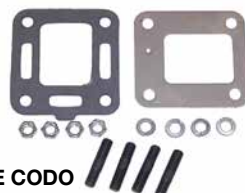

18-8514
KIT DE MONTAJE CODO ESCAPE
 Mercruiser Ford bloques pequeños V8 302-351cu.in. (Modelos: 215, 225, 233, 255, 888), bloques pequeños GM V8 305-351cu.in. (Modelos: 198,228,898)
 Usar con:
 Codo: 18-1971 & 18-1978
 (No para agua dulce/Sistema de refrigeración cerrado)



18-8520
KIT MONTAJE COLECTOR ESCAPE
 Mercruiser bloque pequeño GM V8 305-350cu.in. (Modelos: 198, 200, 228, 230, 260, 898)
 Usar con:
 Colector: 18-1950-1,18-1951-1, 18-1953-2

① Este producto es precio por pieza. Para envasado añadir -9 a la referencia



**18-8529
KIT DE MONTAJE
CODO ESCAPE**
Mer cruiser GM V6 229 y 262cu. in. (Models 185 y 205), GM bloques pequeños V8 305-350cu. in. (Modelos: 200, 228, 230, 260, 898), GM bloques grandes V8 454 cu.in.(Modelos: 330, 340 and 7.4L)
Usar con: Codo: 18-1970-1



**18-8530
KIT DE MONTAJE CODO ESCAPE**
Mer cruiser 4 Cilindro 224cu.in. 3.7L (Modelos: 165, 170, 180, 190)
Usar con:
Codo/Depósito: 18-1937



**18-8531
KIT DE MONTAJE COLECTOR ESCAPE**
Mer cruiser GM Inline 6 Cilindro 250cu.in. (Modelos: 165 and 200)
Usar con :
Colector: 18-1960-1



18-8532
Mer cruiser GM bloque grande V8 454cu. in. (Modelos: 330, 340 y 7.4L)
Usar con:
Colector: 18-1957-1



**18-8533
KIT DE MONTAJE COLECTOR ESCAPE**
Mer cruiser GM V6 229 y 262 cu. in. (Modelos 185 y 205)
Usar con:
Colector: 18-1952-1

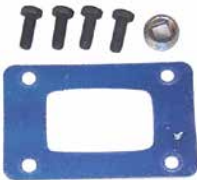

**18-8535 (cerrado)
KIT DE MONTAJE
CODO ESCAPE**
Barr, Indmar y Marine Power Ford bloque pequeño V8 302-351cu.in., GM bloque pequeño V8 305-350cu.in., GM bloque grande V8 454cu.in.
Usar con:
Codo: 18-1939, 18-1999, y 18-1907



**18-8536
KIT DE MONTAJE CODO ESCAPE**
Barr, Indmar y Marine Power GM bloque pequeño V8 305-350cu.in.
Usar con:
Colector: 18-1997-1



**18-8538
KIT MONTAJE COLECTOR ESCAPE**
Barr y Indmar Ford bloque pequeña V8 302-351cu.in.
Usar con:
Colector: 18-1998-1



**18-8554
KIT MONTAJE CODO ESCAPE**
Para: 229 y 262 ci V6, 305 y 350 SB V8, 454 bloque grande V8.
Usar con:
Kit codo: 18-1908K y 18-1908 Espaciador
Codo: 18-1970-1
Colector: 18-1952-1, 18-1953-2 & 18-1957-1



9 1/2" tornillos

**18-8555
KIT MONTAJE CODO ESCAPE**
Para: 229 y 262 ci V6, 305 y 350 SB V8, 454 bloque grande V8.
Usar con:
Kit codo: 18-1908K y 18-1908 Espaciador
Codo: 18-1976-2
Colector: 18-1952-1, 18-1953-2 & 18-1957-1



**18-8556
KIT MONTAJE CODO ESCAPE**
Para: 229 y 262 ci V6, 305 y 350 SB V8, 454 bloque grande V8. Usado para montar espaciador 18-1985 a 18-1953-2, 18-1957-1 y 18-1952-1 colector



KITS TORNILLERÍA

Ref #	Para
18-8548	18-1950-1 & 18-1951-1 colector
18-8549	18-1955-1 colector
18-8551	18-1975-1 codo escape

















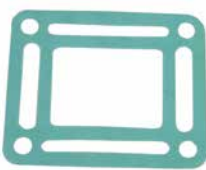
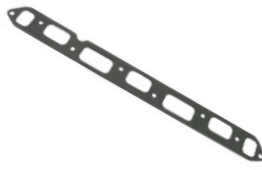

**18-0183-1
JUNTA COLECTOR ESCAPE**
Reemplaza: Mer cruiser 27-73866, 27-54566 Volvo 3853742, 3852455, OMC 908717
Usar con:
Colector: 18-1962-1, 18-1938, 18-1998-1, 18-1996, 18-1979



**18-0353
JUNTA MONTAJE CARBURADOR**
Reemplaza: 27-58764
Usar con:
Colector: 18-1960-1

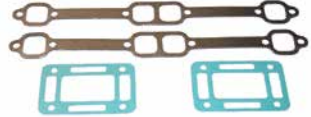

**18-0418
JUNTA COLECTOR ESCAPE**
Reemplaza: 27-46820
Usar con :
Colector: 18-1957-1, 18-1982, 18-1929, 18-1933, 18-1898

 <p>18-0476-1 JUNTA CODO Barr, Indmar & Marine Power Ford bloque pequeño V8 302-351cu.in. Usar con: Codos: 18-1939, 18-1999, 18-1907</p>	<p>Pack de 2</p>  <p>18-0672 18-0672-9① JUNTA CODO ESCAPE Reemplaza: 27-860231,8637251, 27-41811, 27-863725 Usar con: Codo: 18-1970-1, 18-1976-2</p>	 <p>18-0881-1 JUNTA CODO ESCAPE Reemplaza: 27-18272, 27-97863 Incluido en kit de montaje 18-8530. Usar con: Codo: 18-1937</p>	
<p>Pack. de 2</p>  <p>18-0885-1 18-0885-9 ① JUNTA CODO ESCAPE Reemplaza: 27-48042</p>	 <p>18-0897 (Restrictor) JUNTA CODO Reemplaza: 27-41813, 27-860233, 27-863724 Usar con: Codos: 18-1976-2, 18-1970-1</p>	<p>Pack. de 2</p>  <p>18-1204-1 18-1204-1-9 ① JUNTA COLECTOR ESCAPE Reemplaza: 27-96429</p>	<p>Pack. de 2</p>  <p>18-1210 18-1210-9 ① JUNTA TAPA LATERAL Reemplaza: 27-39923</p>
<p>Pack de 2</p>  <p>18-2819-1 18-2819-9 ① JUNTA CODO ESCAPE Reemplaza: 27-39915</p>	 <p>18-2830-1 JUNTA COLECTOR ESCAPE 6 cil. Reemplaza: 27-46401</p>	<p>Pack de 2</p>  <p>18-2832-1 18-2832-1-9 ① JUNTA TAPA LATERAL Reemplaza: 27-480431 Usar con: Colector: 18-1951-1, 18-1950-1, 18-1954-1, 18-1958-1, 18-1955-1, 18-1956-2, 18-1960-1, 18-1962-1 Tapa lateral: 18-4009</p>	<p>Pack de 2</p>  <p>18-2833 18-2833-9 ① JUNTA CODO ESCAPE Reemplaza: 27-99772</p>
<p>Pack de 2</p>  <p>18-2849-1 (abierto) 18-2849-9-1 ① JUNTA CODO ESCAPE Reemplaza: 27-87105-1, 27-818832, 27-863726 Usar con: Codos: 18-1976-2, 18-1970-1</p>	<p>Pack. de 2</p>  <p>18-2854-1 (abierto) 18-2854-9 ① JUNTA CODO ESCAPE Reemplaza: Barr 01-0107 Usar como : Codos: 18-1999, 18-1939, 18-1907</p>	 <p>18-2896-1 JUNTA COLECTOR ESCAPE Reemplaza: 27-52546, 27-32816 GM 4 cil. 153 cu. in. Para modelo 110/120 acople motor parte posterior motor</p>	<p>Pack. de 2</p>  <p>18-2909 18-2909-9 ① JUNTA COLECTOR ESCAPE Para: GM V-6 Usar con: Colector: 18-1952-1</p>
 <p>18-2912-1 JUNTA COLECTOR ESCAPE Reemplaza: 27-53354</p>	<p>Pack de 2</p>  <p>18-2949 18-2949-9 ② JUNTA COLECTOR ESCAPE Reemplaza: Mercruiser 27-33395 Barr CHV-47-000 GM 5.0L & 5.7L Usar con: Colector: 18-1997-1, 18-1950-1, 18-1951-1</p>	 <p>18-0603 KIT JUNTAS COLECTOR ESCAPE Para: motores Ford 302/351 CID Para usar con 18-1998-1</p>	 <p>18-0604 KIT JUNTAS COLECTOR ESCAPE Para: motores GM 305/350 CID Para usar con 18-1997-1</p>

① Precio por envase



**18-0720
JUNTAS (CERRADO)**
Reemplaza: 27-864549A02, 27-864549A1
Para: 4.3L, 5.0L, 5.7L, 6.2L utiliza colector y codo
Usar con: Colector 18-1843 & codo 18-1845



**18-0721
JUNTAS (ABIERTO)**
Reemplaza: 27-864547A02, 27-864547A1
Para: 4.3L, 5.0L, 5.7L, 6.2L utiliza colector y codo
Usar con: colector 18-1843 & codo 18-1845



**18-0722
JUNTAS**
Reemplaza: 27-864850A02, 27-864547A1
Para: 4.3L, 5.0L, 5.7L, 6.2L utiliza colector y codo
Usar con: colector 18-1843 & codo 18-1845



**18-4218
TAPÓN VACIADO**
Reemplaza: 22-87238, 22-16951A1, 22-64426, 22-16951Q1
1/4" NPT
18-3223-9
Pack de 12



**18-4224
ACOPLAMIENTO
CODO**
Reemplaza: 22-806926A1, 22-862210A01
3/4" NPT



**18-4226
TAPÓN**
Reemplaza: 22-806608A1, 22-806608A02



**18-4227
CODO**
Reemplaza: 22-806926, 22-862210



**18-4461
CONECTOR**
Reemplaza: 22-807155
3/4" - 14 NPT x 1" manguera
Entronque de bronce resistente a la corrosión



**18-8216
CONECTOR**
Reemplaza: 22-36305, 22-36305T
1/2" NPT x 3/4" barb
Para: Mercruiser- V6 (229 y 262ci), bloque pequeño V8 (305-350ci), Bloque grande V8 (454ci)

① Referencias acabadas en "D" envasadas - Referencias sin D no envasadas
② Precio por envase

APLICACION JUNTA COLECTOR/CODO

Litros	Modelo	Nota	CID	# Cil	tiempos	Intervalo años	Intervalo Serie numero	colector esc. babor	colector esc. Estribor	Codo escape	Junta tapa lateral	Junta tapa agua babor	Juntas colector	Juntas Escape codo
2.5L	120		153	4	4	1966-1982	2046625 - 6229717						27-52546	18-2819-1
2.5L	120		153	4	4		2324347 - 3377340					18-1995	18-2896-1	18-2819-1
2.5L	120		153	4	4		3377341 - 5192408					18-1995	18-2896-1	18-2819-1
2.5L	120		153	4	4		5192049 - 6229717					18-1995	18-2896-1	18-2819-1
2.5	120		153	4	4	1983-1986	6229718 - B5311853				18-4009		18-1204-1	18-2833
2.5L	2.5L		153	4	4	1987-1989	B531854 - C853255	18-1956-2			18-4009	18-4009	18-1204-1	18-2833
3.0L	140		181	4	4	1968-1982	2508261 - 6229717	18-1955-1		18-1971	18-4009	18-1990	18-2912-1	18-2833
3.0L	140		181	4	4		3332138 - 5157668	18-1955-1				18-4009	18-1203	18-2833
3.0L	140		181	4	4		5157669 - 6229717	18-1955-1				18-4009	18-1203	18-2833
3.0L	140		181	4	4	1983-1986	6229718 - B450800			18-1975-1	18-4009		18-1204-1	18-2833
3.0L	3.0L		181	4	4	1990-1994	C856559 & SUP	18-1956-2		18-1975-1	18-4009		18-1204-1	18-2833
3.0L	3.0L		181	4	4	1987-1989	B450801 - C856558			18-1975-1	18-4009		18-1204-1	18-2833
3.0L	3.0L		181	4	4	1998-2003	L010042 - M679999	18-1956-2		18-1975-1	18-1990		18-1204-1	18-2833
3.0L	3.0L		181	4	4	2003-2010	M680000 & SUP	18-1956-2		18-1975-1			18-0680	18-2833
3.0L	3.0LX		181	4	4	1990-1997	C856559 - K999999	18-1956-2		18-1975-1	18-1990		18-0680	18-2833
3.0L	3.0L MPI / 3.0L EC		181	4	4	2008-2010	A072812 & SUP						18-0680	
	150			4	4		1666495 - 2048046						18-2830-1	
	160			4	4		2048022 - 2770031						18-2830-1	
3.7L	165		224	4	4	1987	B434941 - B774251		ⓐ	18-1937			18-0956-1-1	18-0881-1
3.7L	165		224	4	4	1987	B434941 - B774251		ⓑ				18-0956-1-1	
3.7L	165		224	4	4		2770032 & Sup	18-1960-1				18-4009	18-2830-1	18-2833
3.7L	170		224	4	4	1985-1986	6916779 - B434940		ⓐ	18-1937			18-0956-1-1	18-0881-1
3.7L	170		224	4	4	1985-1986	6916779 - B434940		ⓑ				18-0956-1-1	18-0113-1
3.7L	180		224	4	4	1987	B436391 - B775248		ⓐ	18-1937			18-0956-1-1	18-0881-1
3.7L	180		224	4	4	1987	B436391 - B775248		ⓑ				18-0956-1-1	18-0113-1
3.7L	190		224	4	4	1985-1986	6916779 - B436390		ⓐ	18-1937			18-0956-1-1	18-0881-1
3.7L	190		224	4	4	1985-1986	6916779 - B436390		ⓑ				18-0956-1	18-0113-1
3.7L	3.7L		224	4	4	1988-1989	B774252 & SUP		ⓐ	18-1937			18-0956-1	18-0881-1
3.7L	3.7L		224	4	4	1988-1989	B774252 & SUP		ⓑ				18-0956-1	
3.7L	3.7LX		224	4	4	1988-1989	B775249 & SUP		ⓐ	18-1937			18-0956-1	18-0881-1
3.7L	3.7LX		224	4	4	1988-1989	B775249 & SUP		ⓑ				18-0956-1	18-0113-1
	470		224	4	4	1976-1977	4208730 - 4625579						18-0956-1	18-2833
	470 MCM / 470 MIE		224	4	4	1977-1982	4625580 - 6218036						18-0956-1	18-2833
	470		224	4	4	1983-1984	6218037 - 6916778						18-0956-1	18-0113-1
	485		224	4	4	1980-1982	5685394 - 6218036						18-0956-1	
	488		224	4	4	1983-1984	6170297 - 6916778						18-0956-1	18-0113-1
	140		194	6	4	1963	1538930 - 1725960						18-2830-1	
	150		230	6	4	1964-1966	1666495 - 2048046						18-2830-1	
	160		250	6	4	1967-1969	2048022 - 2770031						18-2830-1	
	165		250	6	4	1970-1981	2770032 - 5813433	18-1960-1		18-1971	18-4009	18-1990	18-2830-1	18-2833
	200		292	6	4	1969	2453769 - 2712072	18-1960-1		18-1971		18-1990	18-2830-1	18-2833
	185	4bb1	229	6	4	1983-1984	6330183 - 6919655	18-1952-1		18-1970-1			18-2909	18-0897
	175		262	6	4	1987	B527955 - B773242	18-1952-1		18-1952-1			18-2909	18-0897

- ⓐ Para motores con colector escape de aluminio
- ⓑ Para motores con colector escape de hierro fundido
- ⓐ 3" (76mm) O.D. & 0 grados angulo
- ⓑ 3" (76mm) O.D. & 15 grados angulo
- ⓐ 4" (102mm) O.D.
- ⓐ 2 piezas colector escape
- ⓑ 1 pieza colector escape
- ⓐ Perno de montaje codo rectangular
- ⓐ Perno de montaje codo cuadrado
- ⓑ Aplicaciones en linea
- ⓐ Aplicación V-drive
- ⓐ Codo estándar
- ⓑ 2" (51mm) codo
- ⓐ 3" (76mm) codo
- ⓑ 6" (152mm) codo
- ⓐ babor
- ⓑ estribor
- ⓐ Motores con una junta diferente al listado.
- ⓑ Colector escape con riel de agua externa
- ⓐ Colector escape sin riel de agua externa
- ⓑ Colector escape ND. Debe convertirse a un sistema de escape de 2 piezas
- ⓐ Motores con sistema de drenaje fácil
- ⓑ motores con sistema de drenaje multipunto
- ⓐ Caja de colector intermedio

APLICACIONES JUNTAS COLECTOR/CODO (Cont.)

Litro	Modelo	Nota	CID	# Cil	tiemp.	Intervalo Año	Intervalo Serie numero	Colector esc babor	Colector esc estribor	Codo escape	Junta tapa lateral	Junta tapa agua babor	Junta colector	Junta codo escape
	185	2bbl	262	6	4	1985-1986	A331455 - B527954	18-1952-1	18-1952-1	18-1970-1			18-2909	18-0897
	185	2bbl	262	6	4	1985-1986	A331455 - B527954	18-1952-1	18-1952-1	18-1976-2			18-2909	18-0897
	205		262	6	4	1985-1986	A331455 - B527954	18-1952-1	18-1952-1	18-1970-1			18-2909	18-0897
	205		262	6	4	1985-1986	A331455 - B527954	18-1952-1	18-1952-1	18-1976-2			18-2909	18-0897
	205		262	6	4	1987	B527955 - B775129	18-1952-1	18-1952-1	18-1976-2			18-2909	18-0897
4.3L	262 MAG EFI GEN +		262	6	4	1996-1997	F803800 - K999999	18-1952-1	18-1952-1	18-1976-2			18-2909	18-0897
4.3L	262 MAG EFI GEN +		262	6	4	1996-1997	F803800 - K999999						18-2909	
4.3L	4.3L		262	6	4	1988-1996	B773243 - F802999	18-1952-1	18-1952-1	18-1976-2			18-2909	18-0897
4.3L	4.3L GEN +		262	6	4	1998-2002	L010044 - M614999	18-1952-1	18-1952-1	18-1976-2			18-2909	18-2849-1
4.3L	4.3L GEN +		262	6	4	1998-2002	L010044 - M614999						18-2909	
4.3L	4.3L GEN +		262	6	4	2002-2004	M615000 - W309999						18-2909	
4.3L	4.3L GEN +		262	6	4	2004-2010	W310000 & SUP						18-2909	
4.3L	4.3L EFI GEN +		262	6	4	1998-2002	L012009 - M322780	18-1952-1	18-1952-1	18-1976-2			18-2909	18-2849-1
4.3L	4.3L EFI GEN +		262	6	4	1998-2002	L01009 - M322780						18-2909	
4.3L	4.3L MPI		262	6	4	2002	M300000 - M614999	18-1952-1	18-1952-1	18-1976-2			18-2909	18-0897
4.3L	4.3L MPI		262	6	4	2002	M300000 - M614999	18-1952-1	18-1952-1	18-1976-2			18-2909	18-2849-1
4.3L	4.3L MPI		262	6	4	2002-2004	M615000 - W309999						18-2909	
4.3L	4.3L MPI		262	6	4	2004-2010	W310000 & SUP						18-2909	
4.3L	4.3L MPI / 4.3L EC		262	6	4	2010-2011	A637496 & SUP						18-2909	
4.3L	4.3L MPI / 4.3L EC		262	6	4	2010-2011	A637496 & SUP						18-2909	
4.3L	4.3LH GEN +		262	6	4	1998-2002	L010044 - M614999	18-1952-1	18-1952-1	18-1976-2			18-2909	18-2849-1
4.3L	4.3LH GEN +		262	6	4	1998-2002	L010044 - M614999						18-2909	
4.3L	4.3LH	4 bbl	262	6	4	1988-1996	B775130 - F802999	18-1952-1	18-1952-1	18-1976-2			18-2909	18-0897
4.3L	4.3LX GEN +	2bbl	262	6	4	1996-1997	F803800 - K999999	18-1952-1	18-1952-1	18-1976-2			18-2909	18-0897
4.3L	4.3LX GEN +	2bbl	262	6	4	1996-1997	F803800 - K999999						18-2909	
4.3L	4.3LXH GEN +		262	6	4	1996-1997	F803814 - K999999	18-1952-1	18-1952-1	18-1976-2			18-2909	18-0897
4.3L	4.3LXH GEN +		262	6	4	1996-1997	F803814 - K999999						18-2909	
5.0L	215		302	8	4	1970	2781153 - 3040410	18-1958-1	18-1962-1	18-1971	18-4009	18-1990	18-0183-1	18-2833
5.0L	215		302	8	4	1971-1972	3040411 - 3385720	18-1958-1	18-1962-1	18-1971	18-4009	18-4009	18-0183-1	18-2833
5.0L	215 MIE		302	8	4	1970	2781153 - 3040410	18-1958-1	18-1962-1	18-1971	18-4009	18-1990	18-0183-1	18-2833
5.0L	215 MIE		302	8	4	1971-1972	3040411 - 3363181	18-1958-1	18-1962-1	18-1971	18-4009	18-4009	18-0183-1	18-2833
5.0L	225	FORD	302	8	4	1973-1974	3385721 - 4166999	18-1958-1	18-1962-1	18-1971	18-4009	18-4009	18-0183-1	18-2833
5.0L	225 MIE	FORD	302	8	4	1973-1974	3385721 - 4176999	18-1958-1	18-1962-1	18-1971	18-4009	18-4009	18-0183-1	18-2833
5.0L	888		302	8	4	1971-1977	3108723 - 4867829	18-1958-1	18-1962-1	18-1971	18-4009	18-4009	18-0183-1	18-2833
5.0L	190		283	8	4	1963-1964	1564539 - 1730903						18-2949	
5.0L	198 MIE		305	8	4	1977	4776402 - 4931099				18-4009	18-4009	18-2949	18-0885-1
5.0L	198 MIE		305	8	4	1977	4776402 - 4931099	18-1950-1	18-1951-1		18-4009	18-4009	18-2949	18-2833
5.0L	200		305	8	4	1985-1987	6899058 - B525981	18-1953-2	18-1953-2	18-1970-1			18-2949	18-0897
5.0L	200		305	8	4	1985-1987	6899058 - B525981	18-1953-2	18-1953-2	18-1976-2			18-2949	18-0897
5.0L	200		305	8	4	1987	B525982 - B774444	18-1953-2	18-1953-2	18-1976-2			18-2949	18-0897
5.0L	228		305	8	4	1977	4765100 - 4888929				18-4009	18-4009	18-2949	18-0885-1
5.0L	228		305	8	4	1977-1982	4888930 - 6218461	18-1950-1	18-1951-1	18-1971	18-4009	18-4009	18-2949	18-2833
5.0L	228		305	8	4	1983-1984	6218462 - 6899268	18-1953-2	18-1953-2	18-1970-1			18-2949	18-0897
5.0L	228		305	8	4	1983-1984	6218462 - 6899268	18-1953-2	18-1953-2	18-1976-2			18-2949	18-0897
5.0L	228 TR		305	8	4	1977-1978	4888930 - 5170008	18-1950-1	18-1951-1	18-1971	18-4009	18-4009	18-2949	18-2833
5.0L	228 TR		305	8	4	1977-1978	4888930 - 5170008	18-1950-1	18-1951-1	18-1971	18-4009	18-4009	18-2949	18-2833
5.0L	228 MIE		305	8	4	1977	4765100 - 4888929				18-4009	18-4009	18-2949	18-0885-1
5.0L	228 MIE		305	8	4	1977-1980	4888930 - 5907057	18-1950-1	18-1951-1		18-4009	18-4009	18-2949	18-2833
5.0L	230		305	8	4	1985-1987	6899269 - B525981	18-1953-2	18-1953-2	18-1970-1			18-2949	18-0897
5.0L	230		305	8	4	1985-1987	6899269 - B525981	18-1953-2	18-1953-2	18-1976-2			18-2949	18-0897
5.0L	230		305	8	4	1987	B525982 - B773739	18-1953-2	18-1953-2	18-1976-2			18-2949	18-0897
5.0L	230 MIE		305	8	4	1981-1987	5907058 - B788151	18-1953-2	18-1953-2	18-1974-1			18-2949	18-0897
5.0L	230 MIE		305	8	4	1981-1987	5907058 - B788151	18-1953-2	18-1953-2	18-1970-1			18-2949	18-0897
5.0L	230 MIE		305	8	4	1981-1987	5907058 - B788151	18-1953-2	18-1953-2	18-1976-2			18-2949	18-0897
5.0L	5.0L		305	8	4	1988-1995	B774445 - F600999	18-1953-2	18-1953-2	18-1976-2			18-2949	18-0897
5.0L	5.0L GEN +		305	8	4	1988-2002	L015751 - M599999	18-1953-2	18-1953-2	18-1976-2			18-2949	
5.0L	5.0L GEN +		305	8	4	1988-2002	M600000 - W309999						18-2949	
5.0L	5.0L GEN +		305	8	4	2004-2010	W310000 & SUP						18-2949	
5.0L	5.0L EFI GEN +		305	8	4	1998-2001	L012052 - M299999	18-1953-2	18-1953-2	18-1976-2			18-2949	18-2849-1
5.0L	5.0L MIE		305	8	4	1988	B788152 - C396832	18-1953-2	18-1953-2	18-1976-2			18-2949	18-0897
5.0L	5.0L MPI		305	8	4	2002	M300000 - M599999	18-1953-2	18-1953-2	18-1976-2			18-2949	18-0897
5.0L	5.0L MPI		305	8	4	2002-2004	M600000 - W309999						18-2949	
5.0L	5.0L MPI		305	8	4	2004-2010	W310000 & SUP						18-2949	
5.0L	5.0LX		305	8	4	1988-1995	B773740 - F600900	18-1953-2	18-1953-2	18-1976-2			18-2949	18-0897
5.0L	898		305	8	4	1977-1982	4762210 - 6218461				18-4009	18-4009	18-2949	18-0885-1
5.0L	898		305	8	4	1977-1982	4762210 - 6218461	18-1950-1	18-1951-1		18-4009	18-4009	18-2949	18-2833
5.0L	898		305	8	4	1983-1984	6218462 - 6899057	18-1953-2	18-1953-2	18-1970-1			18-2949	18-0897
5.0L	898		305	8	4	1983-1984	6218462 - 6899057	18-1953-2	18-1953-2	18-1976-2			18-2949	18-0897
225		GM	327	8	4	1963-1968	1539620 - 2399397						18-2949	
225		GM	327	8	4	1968-1969	2399398 - 2694014				18-4009	18-1990	18-2949	18-0885-1
225 MIE		GM	327	8	4	1968	2278647 - 2399307						18-2949	
225 MIE		GM	327	8	4	1968-1969	2399398 - 2694014				18-4009	18-1990	18-2949	18-0885-1
250			327	8	4	1968-1969	2314301 - 2639854				18-4009	18-1990	18-2949	18-0885-1
250 MIE			327	8	4	1968-1969	2314301 - 2639854				18-4009	18-1990	18-2949	18-0885-1
5.7L	250		350	8	4	1977	4768000 - 4908849				18-4009	18-4009	18-2949	18-0885-1
5.7L	250		350	8	4	1977	4768000 - 4908849	18-1950-1	18-1951-1	18-1971	18-4009	18-4009	18-2949	18-2833
5.7L	255	GM	350	8	4	1975-1976	4175500 - 4499060				18-4009	18-1990	18-2949	18-0885-1
5.7L	255	GM	350	8	4	1976	4499061 - 4767999	18-1950-1	18-1951-1	18-1971	18-4009	18-4009	18-2949	18-2833
5.7L	255 MIE	GM	350	8	4	1975-1976	4175500 - 4499060				18-4009	18-1990	18-2949	18-0885-1
5.7L	255 MIE	GM	350	8	4	1976-1980	4499061 - 5907057	18-1950-1	18-1951-1		18-4009	18-4009	18-2949	18-2833
5.7L	260		350	8	4	1978-1982	4908850 - 6218461	18-1950-1	18-1951-1	18-1971	18-4009	18-4009	18-2949	18-2833
5.7L	260		350	8	4	1983-1987	6218462 - B773304	18-1953-2	18-1953-2	18-1970-1			18-2949	18-0897
5.7L	260		350	8	4	1983-1987	6218462 - B773304	18-1953-2						

APLICACIONES JUNTA COLECTOR/CODO(Cont.)

Litro	Modelo	Nota	CID	# Cil	Temp.	Intervalo Año	Intervalo Serie numero	Colector escape babor	colector esc. estribor	Codo Escape	Junta tapa lateral	Junta tapa agua babor	Junta Colector	Junta Codo escape
5.7L	350 MAG BRAVO / 350 MAG MPI		350	8	4	1995	F415189 - F601999	18-1953-2	18-1953-2	18-1976-2			18-2949	18-0897
5.7L	350 MAG BRAVO GEN + / 350 MAG MPI GEN +		350	8	4	1996-1997	F602000 - K999999	18-1953-2	18-1953-2	18-1976-2			18-2949	18-0897
5.7L	350 MAG EFI / 350 MAG SKI		350	8	4	1994-1996	F215561 - F820706	18-1953-2	18-1953-2	18-1976-2			18-2949	18-0897
5.7L	350 MAG EFI GEN + / 350 MAG SKI GEN +		350	8	4	1996-1997	F820707 - K999999	18-1953-2	18-1953-2	18-1976-2			18-2949	18-0897
5.7L	350 MAG MPI		350	8	4	1998-2001	L010019 - M299999	18-1953-2	18-1953-2	18-1976-2			18-2949	18-2849-1
5.7L	350 MAG MPI		350	8	4	2002	M300000 - M599999	18-1953-2	18-1953-2	18-1976-2			18-2949	18-0897
5.7L	350 MAG MPI		350	8	4	2002-2004	M600000 - W309999						18-2949	
5.7L	350 MAG MPI		350	8	4	2004-2010	W310000 & UP						18-2949	
5.7L	350 MAG MPI / 350 MAG HORIZON		350	8	4	2002	M300000 - M599999	18-1953-2	18-1953-2	18-1976-2			18-2949	18-2849-1
5.7L	350 MAG MPI / 350 MAG HORIZON		350	8	4	2002-2004	M600000 - W309999						18-2949	
5.7L	350 MAG MPI / 350 MAG HORIZON		350	8	4	2004-2007	W310000 - A299999						18-2949	
5.7L	350 MAG MPI / 350 MAG HORIZON / 350 MAG MIE		350	8	4	1999-2001	L304700 - M299999	18-1953-2	18-1953-2	18-1976-2			18-2949	18-2849-1
5.7L	350 MAG MPI / 350 MAG HORIZON / 350 MAG MIE		350	8	4	2002	M300000 - M316999	18-1953-2	18-1953-2	18-1976-2			18-2949	18-2849-1
5.7L	350 MAG MPI / 350 MAG HORIZON / 350 MAG MIE		350	8	4	2002-2007	M317000 - A089999						18-2949	
5.7L	350 MAG MPI / 350 MAG MIE		350	8	4	1998-2001	L002008 - M299999	18-1953-2	18-1953-2	18-1976-2			18-2949	18-2849-1
5.7L	350 MAG MPI / 350 MAG MIE		350	8	4	2002	M300000 - M316999	18-1953-2	18-1953-2	18-1976-2			18-2949	18-0897
5.7L	350 MAG MPI / 350 MAG MIE		350	8	4	2002-2007	M317000 - A089999						18-2949	
5.7L	350 MAG MPI / 350 MAG SKI		350	8	4	1995-1996	F350583 - F799999	18-1953-2	18-1953-2	18-1976-2			18-2949	
5.7L	350 MAG MPI GEN + / 350 MAG SKI GEN +		350	8	4	1998-2001	L002600 - M299999	18-1953-2	18-1953-2	18-1976-2			18-2949	18-2849-1
5.7L	350 MAG MPI GEN + / 350 MAG SKI GEN +		350	8	4	2002	M300000 - M316999	18-1953-2	18-1953-2	18-1976-2			18-2949	18-0897
5.7L	350 MAG MPI GEN + / 350 MAG SKI GEN +		350	8	4	2002-2007	M317000 - A089999				ⓐ		18-2949	18-0897
5.7L	350 MAG MPI GEN + / 350 MAG SKI GEN +		350	8	4	2002-2007	M317000 - A089999				ⓑ		18-2949	
5.7L	350 MAG SKI		350	8	4	1991-1997	D505450 - K999999	18-1953-2	18-1953-2	18-1976-2			18-2949	18-0897
5.7L	5.7L		350	8	4	1988-1997	B773305 - K999999	18-1953-2	18-1953-2	18-1976-2			18-2949	18-0897
5.7L	5.7L GEN +		350	8	4	1998-2002	L010037 - M599999	18-1953-2	18-1953-2	18-1976-2			18-2949	18-2849-1
5.7L	5.7L GEN +		350	8	4	2002-2004	M600000 - W309999						18-2949	
5.7L	5.7L GEN +		350	8	4	2004-2010	W310000 & SUP						18-2949	
5.7L	5.7L EFI		350	8	4	1995-1997	F225560 - K999999	18-1953-2	18-1953-2	18-1976-2			18-2949	18-0897
5.7L	5.7L EFI GEN +		350	8	4	1998-2001	L010035 - M299999	18-1953-2	18-1953-2	18-1976-2			18-2949	18-2849-1
5.7L	5.7L EFI / 5.7L MIE		350	8	4	1997	K040300 - K999999	18-1953-2	18-1953-2	18-1976-2			18-2949	18-0897
5.7L	5.7L MIE		350	8	4	1988-1997	B788152 - K999999	18-1953-2	18-1953-2	18-1976-2			18-2949	18-0897
5.7L	5.7L MIE GEN +		350	8	4	1998-2002	L002003 - M316999	18-1953-2	18-1953-2	18-1976-2			18-2949	18-2849-1
5.7L	5.7L MIE GEN +		350	8	4	2002-2010	M317000 & SUP						18-2949	
5.7L	5.7L MPI / 5.7L MIE		350	8	4	2008-2010	A090000 & SUP						18-2949	
5.7L	5.7L MPI / 5.7L SKI		350	8	4	2008-2010	A090000 & SUP				ⓐ		18-2949	
5.7L	5.7L MPI / 5.7L SKI		350	8	4	2008-2010	A090000 & SUP				ⓑ		18-2949	
5.7L	5.7L SKI		350	8	4	1985-1995	A338553 - F775199	18-1953-2	18-1953-2	18-1970-1			18-2949	18-0897
5.7L	5.7L SKI		350	8	4	1985-1995	A338553 - F775199	18-1953-2	18-1953-2	18-1976-2	ⓐ		18-2949	18-0897
5.7L	5.7L SKI		350	8	4	1996-1997	F775200 - K999999	18-1953-2	18-1953-2	18-1976-2			18-2949	18-0897
5.7L	5.7L SKI		350	8	4	1998-2002	L002005 - M316999	18-1953-2	18-1953-2	18-1976-2			18-2949	18-2849-1
5.7L	5.7L SKI		350	8	4	2002-2010	M317000 & SUP						18-2949	
5.7L	5.7LX		350	8	4	1996-1997	F601000 - K999999	18-1953-2	18-1953-2	18-1976-2			18-2949	18-0897
5.7L	5.7LX BRAVO EFI		350	8	4	1996-1997	F800300 - K999999	18-1953-2	18-1953-2	18-1976-2			18-2949	18-0897
5.7L	5.7LX EFI		350	8	4	1996-1997	F752400 - K999999	18-1953-2	18-1953-2	18-1976-2			18-2949	18-0897
5.7L	BLACK SCORPION SKI		350	8	4	1996-1997	F800000 - K999999	18-1953-2	18-1953-2	18-1976-2			18-2949	18-0897
5.7L	BLACK SCORPION SKI		350	8	4	2003-2007	M391600 - W698432				ⓐ		18-2949	
5.7L	BLACK SCORPION SKI		350	8	4	2003-2007	M391600 - W698432				ⓑ		18-2949	
5.7L	SCORPION 350		350	8	4	2008-2010	W698433 & SUP				ⓐ		18-2949	
5.7L	SCORPION 350		350	8	4	2008-2010	W698433 & SUP				ⓑ		18-2949	
6.2L	233		351	8	4	1975-1977	4173000 - 4902304	18-1958-1	18-1962-1	18-1971	18-4009	18-4009	18-0183-1	18-2833
6.2L	233 MIE		351	8	4	1975-1977	4173000 - 4902304	18-1958-1	18-1962-1	N.L.A.	18-4009	18-4009	18-0183-1	18-2833
6.2L	233 MIE		351	8	4	1975-1977	4173000 - 4902304	18-1958-1	18-1962-1	N.L.A.	18-1990 ⓐ	18-4009	18-0183-1	18-2833
6.2L	255	FORD	351	8	4	1973-1974	3258728 - 4175499	18-1958-1	18-1962-1	18-1971	18-4009	18-4009	18-0183-1	18-2833
6.2L	255 MIE	FORD	351	8	4	1973-1974	3258728 - 4175499	18-1958-1	18-1962-1	18-1971	18-4009	18-4009	18-0183-1	18-2833
6.2L	225 MIE	FORD	351	8	4	1973-1974	3258728 - 4175499	18-1958-1	18-1962-1	18-1971	18-1990 ⓐ	18-4009	18-0183-1	18-2833
6.2L	377 MAG		377	8	4	2008-2010	A300000 & SUP						18-2949	
6.2L	377 SCORPION MCM		377	8	4	1999-2005	L416146 - M907201	18-1953-2	18-1953-2	18-1976-2			18-2949	18-2849-1
6.2L	377 SCORPION SKI		377	8	4	1997-1998	K000656 - L600314	18-1953-2	18-1953-2	18-1976-2			18-2949	18-0897
6.2L	MX 6.2L MPI		377	8	4	2000-2001	L680003 - M299999	18-1953-2	18-1953-2	18-1976-2			18-2949	18-2849-1
6.2L	MX 6.2L MPI		377	8	4	2002	M300000 - M599999	18-1953-2	18-1953-2	18-1976-2			18-2949	18-0897
6.2L	MX 6.2L MPI		377	8	4	2002-2004	M600000 - W309999						18-2949	
6.2L	MX 6.2L MPI		377	8	4	2004-2007	W310000 - A299999						18-2949	
6.2L	MX 6.2L MPI / MX 6.2L HORIZON		377	8	4	2002	M300000 - M599999	18-1953-2	18-1953-2	18-1976-2			18-2949	18-2849-1
6.2L	MX 6.2L MPI / MX 6.2L HORIZON		377	8	4	2002-2004	M600000 - W309999						18-2949	
6.2L	MX 6.2L MPI / MX 6.2L HORIZON		377	8	4	2004-2007	W310000 - A299999						18-2949	
6.2L	MX 6.2L MPI / MX 6.2L HORIZON / MX 6.2L MIE		377	8	4	2002	M300000 - M316999	18-1953-2	18-1953-2	18-1976-2			18-2949	18-2849-1
6.2L	MX 6.2L MPI / MX 6.2L HORIZON / MX 6.2L MIE		377	8	4	2002-2007	M317000 - A089999						18-2949	
6.2L	MX 6.2L MPI / MX 6.2L MIE		377	8	4	1999-2001	L670000 - M299999	18-1953-2	18-1953-2	18-1976-2			18-2949	18-2849-1
6.2L	MX 6.2L MPI / MX 6.2L MIE		377	8	4	2002	M300000 - M316999	18-1953-2	18-1953-2	18-1976-2			18-2949	18-0897
6.2L	MX 6.2L MPI / MX 6.2L MIE		377	8	4	2002-2010	M317000 & SUP						18-2949	

ⓐ Para motores con colector escape de aluminio
 ⓑ Para motores con colectores escape de hierro fundido
 ⓐ 3" (76mm) O.D. & 0 grados angulo
 ⓑ 3" (76mm) O.D. & 15 grados angulo
 ⓐ 4" (102mm) O.D.
 ⓐ 2 piezas colector escape
 ⓑ 1 pieza colector escape
 ⓐ Perno de montaje codo rectangular
 ⓑ Perno de montaje codo cuadrado
 ⓐ Aplicaciones en linea
 ⓑ Aplicaciones V-drive
 ⓐ Codo estándar
 ⓑ 2" (51mm) codo
 ⓐ 3" (76mm) codo
 ⓑ 6" (152mm) codo
 ⓐ babor
 ⓑ Estribor
 ⓐ Motores con una junta diferente al listado.
 ⓑ Colector escape con riel de agua externa
 ⓐ Colector escape sin riel de agua externa
 ⓑ Colector escape N.D. Debe convertirse a un sistema de escape de 2 piezas
 ⓐ Motores con sistema de drenaje fácil
 ⓑ motores con sistema de drenaje multipunto
 ▼ Caja de colector intermedio

APLICACIONES JUNTAS COLECTOR/CODOS (Cont.)

Litros	Modelo	Nota	CID	# Cil	Tiempos	Intervalo Año	Intervalo Numero serie	Colector escape babor	Colector esc. estribor	Codo escape	Junta tapa lateral	Tapa trasera	Junta Colector	Junta codo escape
6.2L	MX 6.2L MPI / MX 6.2L SKI		377	8	4	2002-2007	M317000 - A089999							18-2949
6.2L	MX 6.2L MPI / MX 6.2L SKI		377	8	4	2002-2007	M317000 - A089999							18-2949
6.2L	MX 6.2L BLACK SCORPION SKI		377	8	4	2001-2003	L670015 - M391599	18-1953-2	18-1953-2	18-1976-2				18-2949 18-2849-1
6.2L	MX 6.2L BLACK SCORPION SKI		377	8	4	2003-2007	M391600 - W698432							18-2949
6.2L	MX 6.2L BLACK SCORPION SKI		377	8	4	2003-2007	M391600 - W698432							18-2949
6.2L	SCORPION 377		377	8	4	2008-2010	W698433 & SUP							18-2949
6.2L	SCORPION 377		377	8	4	2008-2010	W698433 & SUP							18-2949
7.4L	325		427	8	4	1968	2278747 - 2313964							18-0418
7.4L	325		427	8	4	1968-1974	2313965 - 3780449				18-4009	18-1990	18-0418	18-0885-1
7.4L	325 MIE		427	8	4	1968	2278747 - 2313964							18-0418
7.4L	325 MIE		427	8	4	1968-1974	2313965 - 3780449				18-4009	18-1990	18-0418	18-0885-1
7.4L	330		454	8	4	1977-1981	4623115 - 6083144				18-4009	18-4009	18-0418	18-0885-1
7.4L	330		454	8	4	1982-1987	6083145 - B816540	18-1957-1	18-1957-1	18-1970-1				18-0418 18-0897
7.4L	330		454	8	4	1982-1987	6083145 - B816540	18-1957-1	18-1957-1	18-1976-2				18-0418 18-0897
7.4L	330 MIE		454	8	4	1977-1981	4623115 - 6083144				18-4009	18-4009	18-0418	18-0885-1
7.4L	340 MIE W/BW		454	8	4	1981-1987	5889914 - B788365	18-1957-1	18-1957-1	18-1974-1				18-0418 18-0897
7.4L	340 MIE W/BW		454	8	4	1981-1987	5889914 - B788365	18-1957-1	18-1957-1	18-1970-1				18-0418 18-0897
7.4L	340 MIE W/BW		454	8	4	1981-1987	5889914 - B788365	18-1957-1	18-1957-1	18-1976-2				18-0418 18-0897
7.4L	350 MIE		454	8	4	1974-1975	3780450 - 4501640				18-4009	18-1990	18-0418	18-0885-1
7.4L	350 MIE		454	8	4	1976	4501641 - 4623109				18-4009	18-4009	18-0418	18-0885-1
7.4L	370 TRS		454	8	4	1978-1985	4179554 - 6721527				18-4009	18-1990	18-0418	18-0885-1
7.4L	370 TRS		454	8	4	1985-1987	6721528 - B714586	18-1957-1	18-1957-1	18-1976-2				18-0418 18-2849-1
7.4L	400 TRS		454	8	4	1980-1986	4179554 - B457644				18-4009	18-1990	18-0418	18-0885-1
7.4L	420		454	8	4	1987-1989	A398941 - B622418							18-0418
7.4L	425		454	8	4	1990-1992	G398941 - D937011							18-0418
7.4L	440 TRS		454	8	4	1983-1986	4179554 - B485220							18-0418
7.4L	450		454	8	4	1995-1996	F347100 - F347277							18-0418
7.4L	450		454	8	4	1995-1996	F347100 - F347277							18-0418
7.4L	450		454	8	4	1995-1996	F347100 - F347277							18-0418
7.4L	454 MAG ALPHA		454	8	4	1986-1988	A631894 - B785148	18-1957-1	18-1957-1	18-1976-2				18-0418 18-0897
7.4L	454 MAG BRAVO		454	8	4	1988-1997	B721206 - K999999	18-1957-1	18-1957-1	18-1976-2				18-0418 18-0897
7.4L	454 MAG EFI		454	8	4	1994-1996	F115700 - F802349	18-1957-1	18-1957-1	18-1976-2				18-0418 18-0897
7.4L	454 MAG EFI / 454 MAG SKI		454	8	4	1995-1996	F215800 - F820099	18-1957-1	18-1957-1	18-1976-2				18-0418 18-0897
7.4L	454 MAG MPI		454	8	4	1996-1997	F802350 - K999999	18-1957-1	18-1957-1	18-1976-2				18-0418 18-0897
7.4L	454 MAG MPI		454	8	4	1998-2001	L010029 - M0224999	18-1957-1	18-1957-1	18-1976-2				18-0418 18-2849-1
7.4L	454 MAG MPI / 454 MAG HORIZON / 454 MAG MIE		454	8	4	1999-2001	L086050 - L674000	18-1957-1	18-1957-1	18-1976-2				18-0418 18-2849-1
7.4L	454 MAG MPI / 454 MAG SKI		454	8	4	1996-1997	F820100 - K999999	18-1957-1	18-1957-1	18-1976-2				18-0418 18-0897
7.4L	525 SC W/BRAVO		454	8	4	1991-1996	D456000 - F877734							18-0418
7.4L	525 SC W/BRAVO		454	8	4	1991-1996	D456000 - F877734							18-0418
7.4L	525 SC W/BRAVO		454	8	4	1991-1996	D456000 - F877734							18-0418
7.4L	525 SC W/SSM		454	8	4	1991-1996	D456000 - F877734							18-0418
7.4L	525 SC W/SSM		454	8	4	1991-1996	D456000 - F877734							18-0418
7.4L	525 SC W/SSM		454	8	4	1991-1996	D456000 - F877734							18-0418
7.4L	7.4L BRAVO		454	8	4	1988-1997	B771113 - K999999	18-1957-1	18-1957-1	18-1976-2				18-0418 18-0897
7.4L	7.4L EFI / 7.4L MIE		454	8	4	1996-1997	F874815 - K999999	18-1957-1	18-1957-1	18-1976-2				18-0418 18-0897
7.4L	7.4L MIE W/BW		454	8	4	1988-1992	B788366 - D715493	18-1957-1	18-1957-1	18-1974-1				18-0418 18-0897
7.4L	7.4L MIE W/BW		454	8	4	1988-1992	B788366 - D715493	18-1957-1	18-1957-1	18-1970-1				18-0418 18-0897
7.4L	7.4L MIE W/BW		454	8	4	1988-1992	B788366 - D715493	18-1957-1	18-1957-1	18-1976-2				18-0418 18-0897
7.4L	7.4L MIE W/HURTH		454	8	4	1989-1992	C391564 - D715493	18-1957-1	18-1957-1	18-1976-2				18-0418 18-0897
7.4L	7.4L MIE		454	8	4	1992-1997	D715494 - K999999	18-1957-1	18-1957-1	18-1976-2				18-0418 18-0897
7.4L	7.4L MPI		454	8	4	1998-2001	L010003 - M024330	18-1957-1	18-1957-1	18-1976-2				18-0418 18-2849-1
7.4L	7.4L MPI / 7.4L MIE		454	8	4	1995-1997	F563052 - K999999	18-1957-1	18-1957-1	18-1976-2				18-0418 18-0897
7.4L	7.4L MPI / 7.4L MIE		454	8	4	1998-2001	L002006 - L674613	18-1957-1	18-1957-1	18-1976-2				18-0418 18-2849-1
7.4L	7.4LX BRAVO EFI		454	8	4	1996-1997	F820000 - K999999	18-1957-1	18-1957-1	18-1976-2				18-0418 18-0897
7.4L	7.4LX BRAVO MPI		454	8	4	1996-1997	F602010 - K999999	18-1957-1	18-1957-1	18-1976-2				18-0418 18-0897
	390 MCM / 390 MIE		482	8	4	1969-1970	2781129 - 3042731				18-1990	18-1990	18-0418	18-0885-1
	496 MAG / 496 HO		496	8	4	2001-2003	M025000 - M687143							18-0418
	496 MAG / 496 HO		496	8	4	2001-2010	M0225000 & SUP							18-0418
	8.1S / 8.1 HO / 8.1 MIE		496	8	4	2001-2003	M026000 - M319190							18-0418
	8.1S / 8.1 HO / 8.1 MIE		496	8	4	2001-2010	M026000 & SUP							18-0418
8.2L	465		502	8	4	1990-1994	C849992 - F213244							18-0418
8.2L	465		502	8	4	1990-1994	C849992 - F213244							18-0418
8.2L	465		502	8	4	1990-1994	C849992 - F213244							18-0418
8.2L	500 BRAVO		502	8	4	1994-1998	F213293 - L001772							18-0418
8.2L	500 BRAVO		502	8	4	1994-1998	F213293 - L001772							18-0418
8.2L	500 BRAVO		502	8	4	1994-1998	F213293 - L001772							18-0418
8.2L	500 GEN +		502	8	4	1999	L414639 - L601036							18-0418
8.2L	500 GEN +		502	8	4	1999	L414639 - L601036							18-0418
8.2L	500 GEN +		502	8	4	1999	L414639 - L601036							18-0418
8.2L	502 MAG BRAVO		502	8	4	1990-1993	C878221 - F114528	18-1957-1	18-1957-1	18-1976-2				18-0418 18-0897
8.2L	502 MAG EFI		502	8	4	1993-1995	D840650 - F802599	18-1957-1	18-1957-1	18-1976-2				18-0418 18-0897
8.2L	502 MAG MPI		502	8	4	1996-1997	F802600 - K999999	18-1957-1	18-1957-1	18-1976-2				18-0418 18-0897
8.2L	502 MAG MPI		502	8	4	1998-2001	L017000 - M024999	18-1957-1	18-1957-1	18-1976-2				18-0418 18-2849-1
8.2L	600 SC		502	8	4	1991-1996	D456489 - F877642							18-0418
8.2L	600 SC		502	8	4	1991-1996	D456489 - F877642							18-0418
8.2L	8.2L MIE		502	8	4	1990-1996	C878221 - F819619	18-1957-1	18-1957-1	18-1976-2				18-0418 18-0897
8.2L	8.2L MIE / 8.2L MPI		502	8	4	1996-1997	F819620 - K999999	18-1957-1	18-1957-1	18-1976-2				18-0418 18-0897
8.2L	8.2L MIE / 8.2L MPI		502	8	4	1998-2001	L002450 - L674200	18-1957-1	18-1957-1	18-1976-2				18-0418 18-2849-1
	500 BULLDOG W/BRAVO		540	8	4	1990-1998	C577254 - L001607							18-0418
	500 BULLDOG W/BRAVO		540	8	4	1990-1998	C577254 - L001607							18-0418
	500 BULLDOG W/BRAVO		540	8	4	1990-1998	C577254 - L001607							18-0418
	500 BULLDOG W/BRAVO		540	8	4	1999-2001	L414620 - M050281							18-0418
	500 BULLDOG W/BRAVO		540	8	4	1999-2001	L414620 - M050281							18-0418
	500 BULLDOG W/BRAVO		540	8	4	1999-2001	L414620 - M050281							18-0418
	500 BULLDOG W/SSM		540	8	4	1990-2001	C577254 - M050261							18-0418
	500 BULLDOG W/SSM		540	8	4	1990-2001	C577254 - M050261							18-0418
	500 BULLDOG W/SSM		540	8	4	1990-2001	C577254 - M050261							18-0418

- ⊙ Para motores con colector escape de aluminio
- ⊙ Para motores con colectores escape de hierro fundido
- ⊙ 3" (76mm) O.D. & 0 grados angulo
- ⊙ 3" (76mm) O.D. & 15 grados angulo
- ⊙ 4" (102mm) O.D.
- ⊙ 2 piezas colector escape
- ⊙ 1 piezas colector escape
- ⊙ Perno de montaje codo rectangular

Características

- Fabricado para superar la calidad del original.
- Filtro alto rendimiento
- Comprobado y aprobado.
- Con válvula by-pass.

Ref #	O.E. #	Aplicación
18-7824-1*	54111, 14957, 32716, 35-802885Q, 35-866340K01, 35-866340Q03, 35-866340Q02, 35-866340K01, 35-866340Q, 52731A1, 52731, 52022, 32717, 14957	Motores GM ① (Filtro corto)
18-7871	35-805809, 35-805809T	D7.3L Diesel
18-7875*	60565, 35-802886Q	Motores Ford (Filtro largo)
18-7876*	52731, 35-16595T, 35-866340Q03, 35-866340Q02, 32-802885Q, 14957, 54111, 52731A1, 52022, 32717, 32716	Motores GM (Filtro largo)
18-7878-1*	803470, 803470Q, 46692, 38463	Motores 60 & 80 HP (Renault) (Filtro corto)
18-7879-1*	41815, 35-802884Q, 35-883702Q, K	Motores GM V-6



FILTRO ACEITE

- ① No usar en motores V-6 equipados con kit de filtro de aceite remoto
- * Envasado en Display

CARTER DE ACEITE Y JUNTAS



Ref No.	OE	OE No.	Aplicación
18-0612	MerCruiser	809910, 14259	Retén trasero de 1 sola pieza; GM Bloque peq V8 (Varilla mano derecha)
18-0613	MerCruiser	93476	Retén trasero de 2 piezas; GM bloque peq. V8 (Varilla mano derecha)
18-0614	MerCruiser	845668T, 850458, 811549	Retén trasero de 1 pieza; GM bloque grande V8 (Varilla mano derecha)
18-0615	MerCruiser	93477T, 93477, 14760, 75639	Retén trasero de 2 piezas; GM bloque grande V8 (Varilla mano derecha)
18-0616	MerCruiser	14244T, 14244	Retén trasero de 1 sola pieza; GM V6 (Varilla mano derecha)

Tornillo drenaje: M12 - 1.75

CULATAS

Las culatas son nuevas y montadas con válvulas de acero inoxidable, asientos de válvula de acero templado, muelles de válvulas, semi-conos, y retenes.
Todas las culatas GM utilizan espárragos de alto rendimiento en lugar de los originales.



18-4485
CULATA
Reemplaza: 938-883490R1, 938-883490, 938-883490R50, 938-884741R
938-884741R50
Para: 5.7L V-8 GM (1987-95) con 12 pernos en el colector de admisión.
Para tapa de válvula con tornillos en el centro



18-4486
CULATA
Reemplaza: 938-883297 1, 938-803860T
Para: 5.7L V-8 GM Vortec (1996-sup) con 8 pernos en el colector de admisión. Para tapa de válvula con tornillos en el perímetro.



18-4486HP
CULATA
Para: Vortec GM bloques pequeños 5.7L alto rendimiento
Completamente ensamblado con carreras y camaras de combustión revisadas. Añade 30hp. sin modificaciones



18-4489
CULATA
Reemplaza: 936-5544, 936-810840
1.94/1.60 válvulas.
Para: 2.5L/3.0L GM (1968-95) (no para modelos MerCruiser LX) (1968-95)



18-4491
CULATA
Reemplaza: 938-827178
Reemplaza 4.3L Vortec V-6 (1996-sup) con 8 pernos en el colector de admisión para tapa de válvula con tornillos en el centro. NOTE: No usar con motores con balancines de rodillos



18-4501
CULATA
Para: 5.0L Vortec



18-4501HP
CULATA
Para: Vortec GM bloque pequeño 5.0L
Completamente ensamblado con carreras y camaras de combustión revisadas. Añade 30hp. sin modificaciones





18-4492
CONJUNTO DE BALANCINES
 Reemplaza: 35329, F3746241, FI1100014, FI1100495
 Para: Motores MCM/MIE Gm V6 & V8(283, 305 & 350 cid)



18-7508
BOMBA DIRECCIÓN
 Reemplaza: 16792A39, 16792A33



18-8227
POLEA BOMBA CON DIRECCIÓN ASISTIDA
 Reemplaza: 73873A1, 73873
 Para: Sterndrives con correa



18-8297
POLEA BOMBA DIRECCIÓN
 Reemplaza: 861578
 Para: Sterndrives con correa serpentin



18-1400
LEVA HIDRÁULICA
 Reemplaza: 17340, 17340T
 GM 4.3L/últimos V-6 /5.0L/5.7L



18-1401
LEVA HIDRÁULICA
 Reemplaza: 56153, F724102
 Ford 302/351
 Ford 5.0L & 5.8L



18-1402
LEVA HIDRÁULICA
 Reemplaza: 72638, 34282, 35583, 46472, 46744, 49117, F2769931, F5232670, FI1100349, FI1100399, FI1100862, FI1100954, FI1101222
 GM 2.5L/120
 Para: Mercruiser 140 (S/N 2508261-6229717), 140/3.0L (S/N 6229718-sup), 3.0L/3.0LX (S/N C856559-sup)

PISTONES



Todos los pistones se suministran completos, con aros, bulón y cierres.

AROS

STD	REEMPLAZA
18-3928	39-74381A1, 39-75422
18-3937	39-17464, 39-65153, 39-67123, 39-34988, F328506, F3892364, FI1100386, FI1100692, FI1101321
-	39-67127
18-3942	39-67132, 39-67119, 39-58096, 39-34479
18-3944	39-75609, FI1101057
.020	
18-3939	39-66217, 39-97125, 39-48344, FI1100387, FI1100783, FI1101134
.030	
18-3938	39-17465, 39-67126, 39-48345, FI1100694, FI1101322, F328516

PISTONES

STD	REEMPLAZA
18-4180	736-2343, 733-66217, 733-2278
18-4161	733-3819, 733-803850T, 733-4028, 24-38191, FI1100779, FI1100780
18-4109	778-9441A3, 759-80661A7, 759-80661A3, 759-8312A2, 759-831210, 759-661010, 759-592010, 778-9015A2
18-4173	735-6370, 735-9686, 735-808674, 735-850097, 735-808674A1, 735-808661, 735-9703, 735-6370, FI1101184, FI1101318, FI1101334, 833232E
.020	
18-4160	733-3818, 733-38181, FI1100781
18-4189	737-6523, 737-6523, 737-879194035, FI1101101
.030	
18-4134	778-9441A5, 759-80661A8, 759-806661A5, 759-9015A4, 759-8312A6, 759-831212, 759-661012, 759-592012
18-4164	735-6371, 735-9687, 735-850098, 735-9431, 735-9704, FI1101185, FI1101320, FI1101336
18-4178	735-9715, 735-97151, 735-9715T1, FI1101317
18-4191	733-3819, 733-38191, 733-803850T, 733-4028, FI1100779, FI1100780

APLICACIÓN PISTON/AROS

Litros	Modelo	Nota	CID	# Cil	tiempos	Años	Número serie	PISTONES			Nota	Aros			Cant. motor.
								Std.	0.02	0.03		Std.	0.02	0.03	
1.6L	100 VASER		98	4	4	2007-2010	W995000 & SUP	-	-	-	-	-	-	-	-
2.5L	120		153	4	4	1964-1986	1666601 - B531853	18-4180	-	-	-	-	-	-	-
2.5L	153		153	4	4	1987-1989	B531854 - C853255	18-4180	-	-	-	-	-	-	-
3.0L	140		181	4	4	1968-1986	2508261 - B450800	18-4161	18-4160	18-4191	18-3937	18-3939	18-3938	4	
3.0L	140			4			3332138 - 5157668	18-4161	18-4160	18-4191	18-3937	18-3939	18-3938	4	
3.0L	140			4			5157669 - 6229717	18-4161	18-4160	18-4191	18-3937	18-3939	18-3938	4	
3.0L	140 / 3.0L			4			6229718 - C856558	18-4161	18-4160	18-4191	18-3937	18-3939	18-3938	4	
3.0L	3.0L		181	4	4	1987-1989	B450801 - C856558	18-4161	18-4160	-	-	-	-	-	
3.0L	3.0L		181	4	4	1990-1994	C856559 - F603999	-	-	-	18-3937	18-3939	18-3938	6	
3.0L	3.0L		181	4	4	1998-2010	L010042 & SUP	-	-	-	-	-	-	-	
3.0L	3.0L MPI		181	4	4	2008-2010	A072812 & SUP	-	-	-	-	-	-	-	
3.0L	3.0LX		181	4	4	1990-1997	C856559 - K999999	-	-	-	-	-	-	-	
3.7L	165 / 3.7L		224	4	4	1987-1989	B434941 - C762299	-	-	(11)	18-4134	-	-	-	
3.7L	170		224	4	4	1985-1986	6916779 - B434940	18-4109	18-4118	18-4134	18-3928	18-3929	-	4	
3.7L	180 / 3.7LX		224	4	4	1987-1989	B436391 - C762299	18-4109	-	(11)	18-4134	-	-	-	
3.7L	190 / 3.7L		224	4	4	1985-1986	6916779 - B436390	18-4109	-	(11)	18-4134	-	-	-	
3.7L	470		224	4	4	1976-1984	4208730 - 6916779	18-4109	18-4118	18-4134	18-3928	18-3929	-	4	
3.7L	485		224	4	4	1980-1982	5685394 - 6218036	18-4109	-	(11)	18-4134	-	-	-	
3.7L	488		224	4	4	1983-1984	6170297 - 6916778	18-4109	-	(11)	18-4134	-	-	-	
	150			4			1666495 - 2048046	18-4180	18-4183	-	-	18-3942	-	-	6
4.1L	160		250	6	4	1987-1989	2048022 - 2770031	-	-	-	18-3942	-	-	-	
4.1L	165		250	6	4	1970-1981	2770032 - 5813433	-	-	-	18-3942	-	-	-	
4.3L	175 / 4.3L			4			B527955 - & sup	18-4173	18-4188	18-4164	18-3937	18-3939	18-3938	6	
3.8L	185	2bbi		4		1983-1984	6330183 - 6919655	-	-	-	18-3944	-	-	-	
4.3L	175 / 4.3L		262	6	4	1987-1992	B527955 - D714106	-	-	-	-	-	-	-	
4.3L	185	2bbi	262	6	4	1985-1986	A331455 - B527954	-	-	18-4164	18-3937	18-3939	-	-	
4.3L	205 / 4.3LX		262	6	4	1985-1986	A331455 - B527954	-	-	18-4164	18-3937	18-3939	18-3938	-	
4.3L	262 MAG EFI GEN +		262	6	4	1987-1991	B527955 - D714369	18-4173	-	-	-	-	-	-	
4.3L	262 MAG EFI GEN +		262	6	4	1996-1997	F803800 - K999999	-	-	-	-	-	-	-	
4.3L	4.3L GEN II		262	6	4	1992-1996	D714107 - F802999	18-4173	18-4188	-	-	-	18-3938	6	
4.3L	4.3L GEN +		262	6	4	1998-2010	L010044 & SUP	-	-	-	-	-	-	-	
4.3L	4.3L EFI GEN +		262	6	4	1998-2001	L012009 - M299999	-	-	-	-	-	-	-	
4.3L	4.3L MPI		262	6	4	2002-2010	M322761 & SUP	-	-	-	-	-	-	-	
4.3L	4.3LH GEN +		262	6	4	1998-2002	L010044 - M614999	-	-	-	-	-	-	-	
4.3L	4.3LX GEN II		262	6	4	1992-1996	D7141370 - F802999	-	-	18-4164	18-3937	18-3939	18-3938	6	
4.3L	4.3LX GEN +		262	6	4	1996-1997	F803000 - K999999	-	-	-	-	-	-	-	
4.3L	4.3LXH GEN +		262	6	4	1996-1997	F803114 - K999999	-	-	-	-	-	-	-	
4.9L	215	FORD	302	8	4	1970-1972	2781153 - 3395720	-	-	-	18-3937	18-3939	18-3938	8	
4.9L	215	FORD		4		1973-1974	3385721 - 4166999	-	-	-	18-3937	18-3939	18-3938	8	
	225	GM		4			1536920 - & Sup	-	-	-	18-3937	18-3939	18-3938	8	
4.6L	190	GM	283	8	4	1963-1964	1564539 - 1730903	18-4180	18-4183	-	18-3942	-	-	6	
5.0L	198 MIE		305	8	4	1977	4776402 - 4931099	-	-	-	-	-	-	-	
5.0L	200		305	8	4	1985-1987	6899058 - B525981	-	-	-	-	-	-	-	
5.0L	200 / 5.0L	GM	305	8	4	1987	B525982 - B774444	-	-	18-4178	18-3944	-	-	8	
	200	GM		4			6218462 - & Sup	-	-	-	18-3944	-	-	8	
5.0L	228	GM	305	8	4	1977-1984	4765100 - 6899268	-	-	-	18-3944	-	-	8	
5.0L	228 MIE		305	8	4	1977-1980	5170009 - 5907057	-	-	-	-	-	-	-	
5.0L	230		305	8	4	1985-1987	6899269 - B525981	-	-	-	-	-	-	-	
5.0L	230		305	8	4	1987-1995	B525982 - B773739	-	-	18-4178	18-3944	-	-	8	
5.0L	230 MIE	GM	305	8	4	1981-1987	5907058 - B522505	-	-	-	18-3944	-	-	8	
5.0L	230 MIE		305	8	4	1987	B522506 - B788151	-	-	18-4178	18-3944	-	-	8	
5.0L	230 GM			8	4		6218462 - & Sup	-	-	-	18-3944	-	-	8	
5.0L	5.0L		305	8	4	1988-1995	B774445 - F600999	-	-	-	-	-	-	-	
5.0L	5.0L GEN +		305	8	4	1998-2010	L015751 & SUP	-	-	-	-	-	-	-	
5.0L	5.0L EFI GEN +		305	8	4	1998-2001	L012052 - M299999	-	-	-	-	-	-	-	
5.0L	5.0L MIE		305	8	4	1988	B788152 - C396682	-	-	-	-	-	-	-	
5.0L	5.0L MPI		305	8	4	2002-2010	M300000 & SUP	-	-	-	-	-	-	-	
5.0L	5.0LX		305	8	4	1988-1995	B773740 - F600999	-	-	-	-	-	-	-	
5.0L	898 / 198	GM	305	8	4	1977-1984	4762210 - 6899057	-	-	-	18-3944	-	-	8	
5.4L	225 MCM / 225 MIE	GM	327	8	4	1963-1969	1539620 - 2694014	-	-	-	-	-	-	-	
5.4L	250 MCM - 250 MIE	GM	327	8	4	1968-1969	2314301 - 2639854	-	-	-	18-3937	18-3939	18-3938	8	
5.7L	250	GM	350	8	4	1977	4768000 - 4908849	18-4173	18-4188	18-4164	18-3937	18-3939	18-3938	8	
5.7L	255	GM	350	8	4	1975-1976	4175500 - 4767999	18-4173	18-4188	18-4164	18-3937	18-3939	18-3938	8	
5.7L	255 MIE	GM	350	8	4	1975-1980	4175500 - 5907057	18-4173	-	-	-	-	-	8	
5.7L	260	GM	350	8	4	1978-1987	4908850 - B773304	18-4173	18-4188	18-4164	18-3937	18-3939	18-3938	8	
5.7L	260 MIE	GM	350	8	4	1981-1987	5907058 - B788151	18-4173	18-4188	18-4164	18-3937	18-3939	18-3938	8	
5.7L	260 / 5.7L	GM	350	8	4		B525982 - & sup	18-4173	18-4188	18-4164	18-3937	18-3939	18-3938	8	
5.7L	270 MCM / 270 MIE		350	8	4	1969-1972	2851074 - 3077735	-	-	-	18-3937	18-3939	18-3938	8	
5.7L	280		350	8	4	1975-1976	4176250 - 4770199	-	-	-	-	-	-	8	
5.7L	300		350	8	4	1985-1988	6668677 - B430367	-	-	-	18-3937	18-3939	18-3938	8	
5.7L	320 EFI		350	8	4	1987-1989	A543604 - C622418	-	-	-	18-3937	18-3939	18-3938	8	
5.7L	320 GM EFI BRAVO			8	4		B157603 - & Sup	-	-	-	18-3937	18-3939	18-3938	8	
	325	GM		4			2278747 - & sup	-	-	-	18-3940	-	-	8	
	330	GM		4			4623115 - & sup	-	18-4189	-	18-3940	-	-	8	
	330 W/B.W.	GM		4			6083145 - & sup	-	18-4189	-	18-3940	-	-	8	
5.7L	350 MAG ALPHA		350	8	4	1986-1997	A635178 - K999999	18-4173	18-4188	18-4164	18-3937	18-3939	18-3938	8	
5.7L	350 MAG ALPHA EFI GEN +		350	8	4	1996-1997	F800300 - K999999	-	-	-	-	-	-	8	
5.7L	350 MAG BRAVO MPI		350	8	4	1995	F415189 - F601999	18-4173	-	18-4164	-	-	-	8	
5.7L	350 MAG BRAVO MPI GEN +		350	8	4	1996-1997	F602000 - K999999	-	-	-	-	-	-	8	
5.7L	350 MAG SKI		350	8	4	1994-1996	F215561 - F820706	18-4173	-	18-4164	F215561	-	-	8	

APLICACIÓN PISTÓN/AROS

Litros	Modelo	Nota	CID	# Cil	tiempos	Años	Número serie	PISTONES			Aros			Cant. motor.
								Std.	Nota	0.02	0.03	Nota	Std.	
5.7L	350 MAG EFI SKI GEN +		350	8	4	1996-1997	F820707 - K999999	-	-	-	-	-	-	8
5.7L	350 MAG MPI GEN +		350	8	4	1998-2010	L010019 & SUP	-	-	-	-	-	-	8
5.7L	350 MAG MPI / 350 MAG HORIZON		350	8	4	2002-2007	M300000 - A299999	-	-	-	-	-	-	8
5.7L	350 MAG MPI / 350 MAG HORIZON / 350 MAG MIE		350	8	4	1998-2007	L304700 - A899999	-	-	-	-	-	-	8
5.7L	350 MAG / 350 MAG MIE / 350 MAG MPI GEN +		350	8	4	1998-2007	L002008 - A089999	-	-	-	-	-	-	8
5.7L	350 MAG MPI SKI		350	8	4	1995-1996	F350583 - F799999	18-4173	-	18-4164	-	-	-	8
5.7L	350 MAG MPI SKI GEN +		350	8	4	1998-2007	L002600 - A089999	-	-	-	-	-	-	8
5.7L	350 MAG SKI		350	8	4	1991-1997	D505450 - K999999	18-4173	18-4188	18-4164	18-3937	18-3939	18-3938	8
5.7L	350	GM	350	8	4		3780450 - & sup	-	-	-	18-3940	-	-	8
5.7L	350 MAG	GM	350	8	4		B525982 - & sup	18-4173	18-4188	18-4164	18-3937	18-3939	18-3938	8
5.7L	5.7L		350	8	4	1988-1995	B773305 - F600999	18-4173	-	18-4164	-	-	-	8
5.7L	5.7L	2bbl	350	8	4	1996-1997	F601000 - K999999	18-4173	-	18-4164	-	-	-	8
5.7L	5.7L GEN +		350	8	4	1998-2010	L010037 & SUP	-	-	-	-	-	-	8
5.7L	5.7L EFI		350	8	4	1995-1997	F225560 - K999999	18-4173	-	18-4164	-	-	-	8
5.7L	5.7L EFI GEN +		350	8	4	1998-2001	L010035 - M299999	-	-	-	-	-	-	8
5.7L	5.7L EFI MIE GEN +		350	8	4	1997	K040300 - K999999	-	-	-	-	-	-	8
5.7L	5.7L MIE		350	8	4	1988-1997	B788152 - K999999	18-4173	-	18-4164	-	-	-	8
5.7L	5.7L MIE GEN +		350	8	4	1998-2010	L002003 & SUP	-	-	-	-	-	-	8
5.7L	5.7L MPI / 5.7L HORIZON / 5.7L MIE		350	8	4	2008-2010	A090000 & SUP	-	-	-	-	-	-	8
5.7L	5.7L MPI / 5.7L MIE		350	8	4	2008-2010	A090000 & SUP	-	-	-	-	-	-	8
5.7L	5.7L MPI / 5.7L SKI		350	8	4	2008-2010	A090000 & SUP	-	-	-	-	-	-	8
5.7L	5.7L SKI		350	8	4	1985-1997	A338553 - K999999	18-4173	-	18-4164	-	-	-	8
5.7L	5.7L SKI GEN +		350	8	4	1998-2010	L002005 & SUP	-	-	-	-	-	-	8
5.7L	5.7L X		350	8	4	1996-1997	F601000 - K999999	18-4173	-	18-4164	-	-	-	8
5.7L	5.7L X BRAVO EFI GEN +		350	8	4	1996-1997	F800300 - K999999	-	-	-	-	-	-	8
5.7L	5.7L X EFI		350	8	4	1996-1997	F752400 - K999999	18-4173	-	18-4164	-	-	-	8
5.7L	BLACK SCORPION SKI GEN +		350	8	4	1998-2007	F800000 - W6988432	-	-	-	-	-	-	8
5.7L	SCORPION 350		350	8	4	2008-2010	W698432 & SUP	-	-	-	-	-	-	8
5.8L	233	FORD	351	8	4	1975-1977	4173000 - 4902304	-	-	-	-	-	-	8
5.8L	255	FORD	351	8	4	1973-1974	3258728 - 4175499	-	-	-	-	-	-	8
6.2L	377 MAG		377	8	4	2008-2009	A000000 - A345479	-	-	-	-	-	-	8
6.2L	377 MAG		377	8	4	2009	A345480 - A345492	-	-	-	-	-	-	8
6.2L	377 MAG		377	8	4	2009	A345493 - A345765	-	-	-	-	-	-	8
6.2L	377 MAG		377	8	4	2009	A345766 - A345767	-	-	-	-	-	-	8
6.2L	377 MAG		377	8	4	2009	A345768 - A346789	-	-	-	-	-	-	8
6.2L	377 MAG		377	8	4	2009-2010	A346790 & SUP	-	-	-	-	-	-	8
6.2L	377 SCORPION STERNDRIVE		377	8	4	2000-2010	L416146 & SUP	-	-	-	-	-	-	8
6.2L	377 SCORPION SKI		377	8	4	1997-1998	K000656 - L600314	-	-	-	-	-	-	8
6.2L	MX 6.2L MPI		377	8	4	2000-2007	L680003 - A299999	-	-	-	-	-	-	8
6.2L	MX 6.2L MPI / MX 6.2L MIE		377	8	4	2002-2009	M300000 - A091825	-	-	-	-	-	-	8
6.2L	MX 6.2L MPI / MX 6.2L MIE		377	8	4	2009-2010	A091826 & SUP	-	-	-	-	-	-	8
6.2L	MX 6.2L MPI / MX 6.2L SKI		377	8	4	2002-2007	M317000 - W689999	-	-	-	-	-	-	8
6.2L	MX 6.2L BLACK SCORPION SKI		377	8	4	2001-2007	L670015 - W698432	-	-	-	-	-	-	8
6.2L	SCORPION 377		377	8	4	2008-2009	W698826 & SUP	-	-	-	-	-	-	8
6.2L	SCORPION 377 HO / SCORPION 377 EC		377	8	4	2009-2010	A091488 - A092170	-	-	-	-	-	-	8
7.4L	325 MCM / 325 MIE		454	8	4	1969-1972	2278747 - 3780449	-	-	-	-	-	-	8
7.4L	330		454	8	4	1977-1987	4623115 - B816540	-	-	-	-	-	-	8
7.4L	330 MIE		454	8	4	1977-1980	4623115 - 5779913	-	-	-	-	-	-	8
7.4L	340 MIE		454	8	4	1981-1987	5899914 - B788365	-	18-4189	-	18-3940	-	-	8
7.4L	350 MIE		454	8	4	1974-1976	3780450 - 4623109	-	-	-	-	-	-	8
7.4L	370 TRS		454	8	4	1978-1987	4719554 - B714586	-	-	-	18-3940	-	-	8
	390	GM	454	8	4		2781129 - 2825059	-	-	-	18-3940	-	-	8
7.4L	400 TRS		454	8	4	1980-1986	4179554 - B457644	-	-	-	18-3940	-	-	8
7.4L	420		454	8	4	1987-1989	A398941 - B6222418	-	-	-	18-3940	-	-	8
7.4L	425		454	8	4	1990-1992	B622419 - D725499	-	-	-	18-3940	-	-	8
7.4L	425 GEN V		454	8	4	1992-1993	D725500 - D937011	-	-	-	-	-	-	8
7.4L	440 TRS		454	8	4	1983-1986	4179554 - B485220	-	-	-	18-3940	-	-	8
7.4L	450 GEN V		454	8	4	1995-1996	F347100 - F347277	-	-	-	-	-	-	8
7.4L	454 MAG ALPHA		454	8	4	1986-1988	A631894 - B785148	-	18-4189	-	18-3940	-	-	8
7.4L	454 MAG BRAVO		454	8	4	1988-1992	D721206 - D805068	-	-	-	-	-	-	8
7.4L	454 MAG BRAVO GEN V		454	8	4	1992-1996	D805069 - F801699	-	-	-	-	-	-	8
7.4L	454 MAG BRAVO GEN VI		454	8	4	1996-1997	F801700 - K999999	-	-	-	-	-	-	8
7.4L	454 MAG EFI GEN V		454	8	4	1994-1996	F115700 - F802349	-	-	-	-	-	-	8
7.4L	454 MAG EFI SKI GEN V		454	8	4	1995-1996	F215800 - F820099	-	-	-	-	-	-	8
7.4L	454 MAG MPI GEN VI		454	8	4	1996-2001	F802350 - M0224999	-	-	-	-	-	-	8
7.4L	454 MAG MPI / 454 MAG HORIZON / 454 MAG MIE		454	8	4	1998-2001	L002200 - L674000	-	-	-	-	-	-	8
7.4L	454 MAG MPI SKI GEN VI		454	8	4	1996-1997	F820100 - K999999	-	-	-	-	-	-	8
7.4L	454 MAG BRAVO		454	8	4		B840126 - & Sup	-	-	-	18-3940	-	-	8
	470		454	8	4		4208730 - & Sup	18-4109	18-4118	18-4134	18-3928	18-3929	-	4
	485		454	8	4		5685394 - & Sup	18-4109	18-4118	18-4134	18-3928	18-3929	-	4
	488		454	8	4		6170297 - & Sup	18-4109	18-4118	18-4134	18-3928	18-3929	-	4
	525 SC		454	8	4	1991-1992	D456000 - D725808	-	-	-	-	-	-	8
7.4L	525 SC GEN V		454	8	4	1992-1996	D763746 - F348963	-	-	-	-	-	-	8
7.4L	525 SC GEN V		454	8	4	1996-1999	F615814 - L415623	-	-	-	-	-	-	8

- | | |
|---|---------------------------------------|
| (1) Aluminio fundido (Usar con motor GM Código 1XW) | (7) Cabeza plana |
| (2) Aluminio fundido (Usar con motor GM Código 4XW) | (8) Aluminio forjado, cabeza rebajada |
| (3) Aluminio forjado (Usar con motor GM Código 3UB) | (9) Estribor |
| (4) Aluminio fundido (Usar con motor GM código 4XX) | (10) Babor |
| (5) Aluminio fundido (Usar con motor GM Código 2XY) | (11) .010 (25mm) tamaño |
| (6) Aluminio fundido (Usar con motor GM Código 4XY) | N.L.A. N/O en original |

APLICACIÓN PISTÓN/AROS

Litro	Modelo	Nota	CID	# Cil	tiempos	Año	Número serie	PISTONES			Nota	Aros			Cant. motor.
								Std.	0.02	0.03		Std.	0.02	0.03	
7.4L	7.4L BRAVO		454	8	4	1988-1991	B771113 - D603117	-	-	-	-	-	-	-	8
7.4L	7.4L BRAVO I GEN V / 7.4L BRAVO II GEN V		454	8	4	1992-1995	D603118 - F800699	-	1	-	-	-	-	-	8
7.4L	7.4L BRAVO I GEN V / 7.4L BRAVO II GEN V		454	8	4	1992-1996	D603118 - F800699	-	2	-	-	-	-	-	8
7.4L	7.4L BRAVO III GEN V		454	8	4	1992-1995	D603118 - F800699	-	3	-	-	-	-	-	8
7.4L	7.4L BRAVO III GEN V		454	8	4	1992-1996	D603118 - F800699	-	4	-	-	-	-	-	8
7.4L	7.4L BRAVO GEN VI		454	8	4	1996-1997	F800700 - K999999	-	-	-	-	-	-	-	8
7.4L	7.4L EFI GEN VI / 7.4L MIE GEN VI / 7.4L GEN VI MIE		454	8	4	1996-1997	F874815 - K999999	-	-	-	-	-	-	-	8
7.4L	7.4L MIE W/HURTH		454	8	4	1988-1992	B788366 - D715493	-	-	-	-	-	-	-	8
7.4L	7.4L W/HURTH		454	8	4		C391564 - & sup	-	-	18-4189	-	18-3940	-	-	8
7.4L	7.4L MIE GEN V		454	8	4	1992-1995	D715494 - F820141	-	5	-	-	-	-	-	8
7.4L	7.4L MIE GEN V		454	8	4	1992-1996	D715494 - F820141	-	5	-	-	-	-	-	8
7.4L	7.4L MIE GEN VI		454	8	4	1996-1997	F820142 - K999999	-	-	-	-	-	-	-	8
7.4L	7.4L MPI GEN VI		454	8	4	1998-2001	L010003 - M024330	-	-	-	-	-	-	-	8
7.4L	7.4L MPI GEN V / 7.4L MIE GEN V		454	8	4	1995-1996	F563052 - F820103	-	-	-	-	-	-	-	8
7.4L	7.4L MPI GEN VI / 7.4L MIE GEN VI / 7.4LH GEN VI		454	8	4	1996-1997	F820104 - K999999	-	-	-	-	-	-	-	8
7.4L	7.4L MPL-29 GEN VI / 7.4L MIE L-29 GEN VI		454	8	4	1998-2001	L002006 - M025999	-	-	-	-	-	-	-	8
7.4L	7.4LX BRAVO GEN VI / 7.4L BRAVO EFI		454	8	4	1996-1997	F802000 - K999999	-	-	-	-	-	-	-	8
7.4L	7.4LX BRAVO GEN V / 7.4L MPI GEN V		454	8	4	1996	F602010 - F801999	-	-	-	-	-	-	-	8
7.4L	7.4LX BRAVO GEN VI / 7.4L MPI GEN VI		454	8	4	1996-1997	F802000 - K999999	-	-	-	-	-	-	-	8
7.9L	390		482	8	4	1969-1970	2781129 - 2825059	-	-	-	-	-	-	-	8
7.9L	460 TRS		482	8	4	1983-1986	4179554 - 6181046	-	-	-	-	-	-	-	8
8.1L	496		482	8	4	2001-2010	M025000 & SUP	-	9	-	-	-	-	-	8
8.1L	496		496	8	4	2001-2010	M025000 & SUP	-	10	-	-	-	-	-	8
8.2L	465		502	8	4	1990-1992	C849992 - D725646	-	-	-	-	-	-	-	8
8.2L	465 GEN V		502	8	4	1992-1994	D725647 - F213244	-	-	-	-	-	-	-	8
8.2L	500 GEN V		502	8	4	1994-1996	F213293 - F745159	-	-	-	-	-	-	-	8
8.2L	500 GEN VI		502	8	4	1997-1999	K745195 - L601036	-	-	-	-	-	-	-	8
8.2L	500 EFI		502	8	4	1999-2005	L001477 - M907127	-	-	-	-	-	-	-	8
8.2L	502 MAG BRAVO		502	8	4	1990-1992	C878221 - D824588	-	-	-	-	-	-	-	8
8.2L	502 MAG BRAVO GEN V		502	8	4	1992-1993	D824589 - F114528	-	-	-	-	-	-	-	8
8.2L	502 MAG EFI		502	8	4	1993-1996	D640650 - F802599	-	-	-	-	-	-	-	8
8.2L	502 MAG MPI GEN VI		502	8	4	1996-2001	F802600 - M024999	-	-	-	-	-	-	-	8
8.2L	525 EFI		502	8	4	2003-2010	M900146 & SUP	-	-	-	-	-	-	-	8
8.2L	575 Sci		502	8	4	2001-2005	L306696 - M950526	-	-	-	-	-	-	-	8
8.2L	600 SC		502	8	4	1991-1992	D456489 - D456768	-	-	-	-	-	-	-	8
8.2L	600 SC GEN V		502	8	4	1992-1996	D725676 - F877642	-	-	-	-	-	-	-	8
8.2L	600 SC GEN VI		502	8	4	1997-2000	K000227 - L601186	-	-	-	-	-	-	-	8
8.2L	8.2L MAG EC		502	8	4	2010	A350340 & SUP	-	-	-	-	-	-	-	8
8.2L	8.2L MIE / 8.2L EC		502	8	4	2010	A350802 & SUP	-	-	-	-	-	-	-	8
8.2L	8.2L MIE W/HURTH		502	8	4	1990-1992	C878221 - D857199	-	-	-	-	-	-	-	8
8.2L	8.2L MIE GEN V		502	8	4	1993-1995	D857200 - F819619	-	-	-	-	-	-	-	8
8.2L	8.2L MPI GEN VI / 8.2L MIE GEN VI / 8.2LH GEN VI		502	8	4	1996-2001	F819620 - L674200	-	-	-	-	-	-	-	8
8.9L	500 BULLDOG		540	8	4	1990-2001	C577254 - M050281	-	-	-	-	-	-	-	8
8.9L	575		540	8	4	1986-1992	A677429 - D763716	-	7	-	-	18-3937	18-3939	18-3938	8

- | | |
|---|---------------------------------------|
| (1) Aluminio fundido (Usar con Motor GM Codigo 1XW) | (7) Cabeza plana |
| (2) Aluminio fundido (Usar con motor GM Codigo 4XW) | (8) Aluminio forjado, Cabeza rebajada |
| (3) Aluminio forjado (Usar con motor GM Codigo 3UB) | (9) Estribor |
| (4) Aluminio fundido (Usar con motor GM Codigo 4XX) | (10) Babor |
| (5) Aluminio fundido (Usar con motor GM Codigo 2XY) | (11) .010 (25mm) tamaño |
| (6) Aluminio fundido (Usar con motor GM Codigo 4XY) | N.L.A. N/O en original |

 <p>COJINETE BIELA</p>	 <p>COJINETE CIGÜEÑAL</p>	 <p>COJINETE LEVA</p>																																																												
<table border="1"> <thead> <tr> <th>Ref No.</th> <th>talla</th> <th>Reemplaza Mercruiser:</th> </tr> </thead> <tbody> <tr> <td>18-1148</td> <td>Std.</td> <td>68704A1, 23-853853, 23-853853A1, 23-853853002</td> </tr> <tr> <td>18-1308</td> <td>Std.</td> <td>23-85701, 23-15961, 23-52221, 23-52270, F3910555, F3916351, F11100305, F11100570</td> </tr> <tr> <td>18-1309</td> <td>0.01</td> <td>23-85704, 23-52224, 23-52273, 23-1596110, F11100381, F11100573</td> </tr> <tr> <td>18-1327</td> <td>Std.</td> <td>23-11992, 23-11992001</td> </tr> <tr> <td>18-1329</td> <td>Std.</td> <td>23-85677, 23-52242, 23-48351</td> </tr> <tr> <td>18-1333</td> <td>0.01</td> <td>23-85691, 23-69887, 23-49171</td> </tr> <tr> <td>18-1334</td> <td>Std.</td> <td>23-85726, 23-85726001, 23-49168, 23-69884, F11100980</td> </tr> <tr> <td>18-1337</td> <td>0.01</td> <td>23-811858, 23-811858001</td> </tr> <tr> <td>18-1341</td> <td>0.02</td> <td>23-85705, 23-1596120, 23-52225, 23-52274, F11100382</td> </tr> </tbody> </table>	Ref No.	talla	Reemplaza Mercruiser:	18-1148	Std.	68704A1, 23-853853, 23-853853A1, 23-853853002	18-1308	Std.	23-85701, 23-15961, 23-52221, 23-52270, F3910555, F3916351, F11100305, F11100570	18-1309	0.01	23-85704, 23-52224, 23-52273, 23-1596110, F11100381, F11100573	18-1327	Std.	23-11992, 23-11992001	18-1329	Std.	23-85677, 23-52242, 23-48351	18-1333	0.01	23-85691, 23-69887, 23-49171	18-1334	Std.	23-85726, 23-85726001, 23-49168, 23-69884, F11100980	18-1337	0.01	23-811858, 23-811858001	18-1341	0.02	23-85705, 23-1596120, 23-52225, 23-52274, F11100382	<table border="1"> <thead> <tr> <th>Ref No.</th> <th>Para mot.</th> <th>talla</th> <th>Reemplaza Mercruiser:</th> </tr> </thead> <tbody> <tr> <td>18-1300</td> <td>①</td> <td>Std.</td> <td>23-818465, 23-85698, 23-52211, 23-15960, F724073</td> </tr> <tr> <td>18-1311</td> <td>①</td> <td>Std.</td> <td>23-801793</td> </tr> <tr> <td>18-1315</td> <td>①</td> <td>Std.</td> <td>23-818473, 23-818473001, 23-49163, 23-85686, F347013, F11100912, F11101293</td> </tr> <tr> <td>18-1316</td> <td>①</td> <td>0.010</td> <td>23-818471, 23-818471001, 23-52264, 23-85718, F3829064, F11100853</td> </tr> <tr> <td>18-1317</td> <td>①</td> <td>Std.</td> <td>23-818469, 23-818469001, 23-34464, 23-85669, 23-85715, 23-52261,</td> </tr> </tbody> </table>	Ref No.	Para mot.	talla	Reemplaza Mercruiser:	18-1300	①	Std.	23-818465, 23-85698, 23-52211, 23-15960, F724073	18-1311	①	Std.	23-801793	18-1315	①	Std.	23-818473, 23-818473001, 23-49163, 23-85686, F347013, F11100912, F11101293	18-1316	①	0.010	23-818471, 23-818471001, 23-52264, 23-85718, F3829064, F11100853	18-1317	①	Std.	23-818469, 23-818469001, 23-34464, 23-85669, 23-85715, 23-52261,	<table border="1"> <thead> <tr> <th>Ref No.</th> <th>Para mot.</th> <th>Reemplaza Mercruiser:</th> </tr> </thead> <tbody> <tr> <td>18-1339</td> <td>1 ①</td> <td>23-43293, 23-43293T, F3750884, F11101007</td> </tr> </tbody> </table>	Ref No.	Para mot.	Reemplaza Mercruiser:	18-1339	1 ①	23-43293, 23-43293T, F3750884, F11101007
Ref No.	talla	Reemplaza Mercruiser:																																																												
18-1148	Std.	68704A1, 23-853853, 23-853853A1, 23-853853002																																																												
18-1308	Std.	23-85701, 23-15961, 23-52221, 23-52270, F3910555, F3916351, F11100305, F11100570																																																												
18-1309	0.01	23-85704, 23-52224, 23-52273, 23-1596110, F11100381, F11100573																																																												
18-1327	Std.	23-11992, 23-11992001																																																												
18-1329	Std.	23-85677, 23-52242, 23-48351																																																												
18-1333	0.01	23-85691, 23-69887, 23-49171																																																												
18-1334	Std.	23-85726, 23-85726001, 23-49168, 23-69884, F11100980																																																												
18-1337	0.01	23-811858, 23-811858001																																																												
18-1341	0.02	23-85705, 23-1596120, 23-52225, 23-52274, F11100382																																																												
Ref No.	Para mot.	talla	Reemplaza Mercruiser:																																																											
18-1300	①	Std.	23-818465, 23-85698, 23-52211, 23-15960, F724073																																																											
18-1311	①	Std.	23-801793																																																											
18-1315	①	Std.	23-818473, 23-818473001, 23-49163, 23-85686, F347013, F11100912, F11101293																																																											
18-1316	①	0.010	23-818471, 23-818471001, 23-52264, 23-85718, F3829064, F11100853																																																											
18-1317	①	Std.	23-818469, 23-818469001, 23-34464, 23-85669, 23-85715, 23-52261,																																																											
Ref No.	Para mot.	Reemplaza Mercruiser:																																																												
18-1339	1 ①	23-43293, 23-43293T, F3750884, F11101007																																																												
<p>Se venden individualmente, 1 por biela</p>																																																														
<p>① Conjunto completo del motor</p>																																																														

HP	Litros	Modelo	Nota	CID	# Cil	tiempos	año	Número serie	COJINETE BIELA			COJINETE PRINCIPAL			COJINETE LEVA
									Std.	0.01	0.02	Std.	0.01	0.02	
100		100 VASER		98	4	4	2007-2010	W995000 & SUP	-	-	-	-	-	-	-
120		120		153	4	4	1964-1986	1666601 - B531853	18-1329	-	-	-	-	-	-
120	2.5L	120/2.5L		153	4	4	1987-1989	B531854 - C853255	18-1329	18-1330	-	18-1317	18-1316	-	18-1339
140		140		181	4	4	1968-1986	2508261 - B450800	18-1308	18-1309	18-1341	18-1317	18-1316	-	18-1331
140		140		181	4	4		3462608 - 5157668	18-1308	18-1309	18-1341	18-1317	18-1316	-	18-1339
140		140		181	4	4		5157669 - 6229717	18-1308	18-1309	18-1341	18-1317	18-1316	-	18-1339
140	3.0L	140 / 3.0L		181	4	4		6229718 & sup	18-1308	18-1309	18-1341	18-1317	18-1316	-	18-1339
	3.0L	3.0L		181	4	4	1987-1989	B450801 - C856558	18-1308	-	-	-	-	-	-
	3.0L	3.0L		181	4	4	1990-1994	C856559 - F603999	18-1308	18-1309	18-1341	18-1317	18-1316	-	18-1339
	3.0L	3.0L		181	4	4	1998-1999	L010042 - L605541	18-1308	-	-	-	-	-	-
	3.0L	3.0L		181	4	4	2000-2010	L605542 & SUP	-	-	-	-	-	-	-
	3.0L	3.0L MPI		181	4	4	2008-2010	A07282 & SUP	-	-	-	-	-	-	-
	3.0L	3.0LX		181	4	4	1990-1997	C856559 - K999999	18-1308	-	18-1341	-	-	-	-
		165		224	4	4	1987	B434941 - B774251	-	-	-	-	-	-	-
		170		224	4	4	1985-1986	6916779 - B434940	-	-	-	-	-	-	-
		180		224	4	4	1987	B436391 - B775248	-	-	-	-	-	-	-
		190		224	4	4	1985-1986	6916779 - B436390	-	-	-	-	-	-	-
3.7L	3.7L			224	4	4	1988-1989	B774252 - C762299	-	-	-	-	-	-	-
3.7L	3.7LX			224	4	4	1988-1989	B775249 - C762299	-	-	-	-	-	-	-
		470		224	4	4	1976-1984	4208730 - 6916778	-	-	-	-	-	-	-
		485		224	4	4	1980-1982	5685394 - 6218036	-	-	-	-	-	-	-
		488		224	4	4	1983-1984	6170297 - 6916778	-	-	-	-	-	-	-
		140			6	4		1538930 - 1725960	18-1329	18-1330	-	-	-	-	-
		150				4		1666495 - 2048046	18-1329	18-1330	-	-	-	-	-
		160		250	6	4	1967-1969	2048022 - 2770031	18-1329	18-1330	-	-	18-1320	-	-
		165		250	6	4	1970-1981	2770032 - 5813433	18-1329	18-1330	-	-	18-1320	-	-
4.3L	175 / 4.3L			262	6	4		B527955 & Sup	18-1327	18-1337	18-1338	18-1311	-	-	-
		185	4bbl	262	6	4	1983-1984	6330183 - 6919655	-	-	-	-	-	-	-
		175		262	6	4	1987	B527955 - B773242	-	-	-	-	-	-	-
		185	2bbl	262	6	4	1985-1986	A331455 - B527954	-	-	-	-	-	-	-
		205		262	6	4	1985-1986	A331455 - B527954	-	-	-	18-1300	-	-	-
4.3L	262 MAG / 262 EFI / 262 GEN +			262	6	4	1996-1997	F803800 - K999999	-	-	-	-	-	-	-
4.3L	4.3L GEN II			262	6	4	1992-1996	D714107 - F802999	18-1327	18-1337	18-1338	18-1311	-	-	-
4.3L	4.3L GEN +			262	6	4	1998-2010	L010044 & SUP	-	-	-	-	-	-	-
4.3L	4.3L EFI / 4.3L GEN +			262	6	4	1998-2001	L012009 - M299999	-	-	-	-	-	-	-
4.3L	4.3L MPI			262	6	4	2002-2010	M3000000 & SUP	-	-	-	-	-	-	-
4.3L	4.3LH GEN +			262	6	4	1998-2002	L010044 - M614999	-	-	-	-	-	-	-
4.3L	4.3LX			262	6	4	1988-1991	B775130 - D714369	-	-	-	-	-	-	-
4.3L	4.3LX GEN II			262	6	4	1992-1996	D714370 - F802999	-	-	-	-	-	-	-
4.3L	4.3LX GEN +			262	6	4	1996-1997	F803000 - K999999	-	-	-	-	-	-	-
4.3L	4.3LXH GEN +			262	6	4	1996-1997	F803114 - K999999	-	-	-	-	-	-	-
		185		262	6	4		A331455 & SUP	18-1327	18-1337	18-1338	18-1311	-	-	-
		205		262	6	4		A331455 & SUP	18-1327	18-1337	18-1338	18-1311	-	-	-
4.3L	205 / 4.3L / 4.3LX LX			262	6	4		B527955 & SUP	18-1327	18-1337	18-1338	18-1311	-	-	-
		4.3LX GEN II		262	6	4		D714370 & SUP	18-1327	18-1337	18-1338	18-1311	-	-	-
		190	GM	283	8	4	1963-1964	1564539 - 1730903	18-1329	18-1330	-	-	-	-	-
		200						2453769 - 2712072	18-1308	18-1309	18-1341	18-1317	18-1316	-	-
		200	GM			4		6218462 & Sup	18-1308	18-1309	18-1341	18-1300	-	-	-
5.0L	500				8	4		B525982 & Sup	18-1308	18-1309	18-1341	18-1300	-	-	-
5.0L	215		FORD	302	8	4		2781153 - 3395720	18-1336	-	-	-	-	-	-
5.0L	225		FORD	302	8	4	1973-1974	3385721 - 4166999	18-1329	18-1330	-	-	-	-	-
5.0L	225 S		FORD	302	8	4	1973-1974	3385721 - 4166999	-	-	-	-	-	-	-
5.0L	225		GM		8	4		1536920 - 2278646	18-1329	18-1330	-	-	-	-	-
5.0L	225		GM		8	4		2278647 - 2399397	18-1329	18-1330	-	18-1317	18-1316	-	-
5.0L	225		GM		8	4		2399398 & Sup	18-1308	18-1309	18-1341	18-1300	-	-	-
5.0L	225		GM		8	4		4765100 & Sup	18-1308	18-1309	18-1341	18-1300	-	-	-
5.0L	888			302	8	4	1971-1977	3108723 - 4887829	-	-	-	-	-	-	-
		190		283	8	4	1963-1964	1564539 - 1730903	18-1329	-	-	-	-	-	-
5.0L	198 MIE			305	8	4	1977	4776402 - 4931099	18-1308	-	-	-	-	-	-
5.0L	200			305	8	4	1985-1987	6899058 - B774444	18-1308	-	-	-	-	-	-
5.0L	228			305	8	4	1977-1984	4765100 - 6899268	18-1308	-	-	-	-	-	-
5.0L	228 MIE			305	8	4	1977-1980	4765100 - 5907057	18-1308	-	-	-	-	-	-
5.0L	230			305	8	4	1985-1987	6899269 - B773739	18-1308	-	-	-	-	-	-
5.0L	230		GM	305	8	4	1981-1987	5907058 - B788151	18-1308	18-1309	18-1341	18-1300	-	-	-
5.0L	5.0L			305	8	4	1988-1995	B774445 - F600999	18-1308	-	-	-	-	-	-
5.0L	5.0L GEN +			305	8	4	1998-2010	L015751 & SUP	18-1308	-	-	-	-	-	-
5.0L	5.0L EFI GEN +			305	8	4	1998-2001	L012052 - M299999	18-1308	-	-	-	-	-	-
5.0L	5.0L MIE			305	8	4	1988	B788152 - C396832	18-1308	-	-	-	-	-	-
5.0L	5.0L MPI			305	8	4	2002-2010	M3000000 & SUP	18-1308	-	-	-	-	-	-
5.0L	5.0LX			305	8	4	1988-1995	B773740 - F600999	18-1308	-	-	-	-	-	-
5.0L	230 / 5.0L		GM	305	8	4		B522506 & Sup	18-1308	18-1309	18-1341	18-1300	-	-	-
		230	GM		8	4		6218462 & Sup	18-1308	18-1309	18-1341	18-1300	-	-	-
5.0L	230 / 5.0L / 5.0LX		GM	305	8	4		B525982 & Sup	18-1308	18-1309	18-1341	18-1300	-	-	-
5.0L	898			305	8	4	1977-1984	4762210 - 6899057	18-1308	-	-	-	-	-	-
		225	GM	327	8	4	1963-1967	1539620 - 2399397	18-1329	-	-	-	-	-	-
		225	GM	327	8	4	1968-1969	2399398 - 2694014	18-1308	-	-	-	-	-	-

HP	Litro	Modelo	Nota	CID	# Cil	tiempos	Años	Número serie	COJINETE BIELA			COJINETE PRINCIPAL			COJINETE LEVA
									Std.	0.01	0.02	Std.	0.01	0.02	
		250		327	8	4	1968-1969	2314301 - 2639854	18-1308	18-1309	18-1341	18-1300	-	-	-
	5.7L	250		350	8	4	1977	4768000 - 4908849	18-1308	18-1309	18-1341	18-1300	-	-	-
	5.7L	255	GM	350	8	4	1975-1976	4175500 - 4767999	18-1308	18-1309	18-1341	18-1300	-	-	-
	5.7L	255 MIE		350	8	4	1975-1980	4175500 - 5907057	18-1308	-	-	-	-	-	-
	5.7L	260	GM	350	8	4	1978-1987	4908850 - B773304	18-1308	18-1309	18-1341	18-1300	-	-	-
	5.7L	260 MIE		350	8	4	1981-1987	5907058 - B788151	18-1308	18-1309	18-1341	-	-	-	-
	5.7L	260 / 5.7L	GM	350	8	4		B525982 & sup	18-1308	18-1309	18-1341	18-1300	-	-	-
	5.7L	260 / 5.7L	GM	350	8	4		B522506 & sup	18-1308	18-1309	18-1341	18-1300	-	-	-
	5.7L	270	GM	350	8	4	1969-1972	2851074 - 3077735	18-1308	18-1309	18-1341	18-1300	-	-	-
	5.7L	280	GM	350	8	4	1975-1976	4176250 - 4770199	18-1308	18-1309	18-1341	18-1300	-	-	-
	5.7L	300	GM	350	8	4	1985-1986	6668677 - B430367	18-1308	18-1309	18-1341	18-1300	-	-	-
	5.7L	320 EFI	GM	350	8	4	1987-1989	A543604 - C622418	18-1308	18-1309	18-1341	18-1300	-	-	-
	5.7L	320 EFI BRAVO	GM	350	8	4		B157603 & sup	18-1308	18-1309	18-1341	18-1300	-	-	-
		325 GM			8	4		2278747 & sup	18-1334	18-1333	18-1332	18-1315	-	-	-
		330 GM			8	4		4623115 & sup	18-1334	18-1333	18-1332	18-1315	-	-	-
		330 W.B.W.	GM		8	4		6083045 & sup	18-1334	18-1333	18-1332	18-1315	-	-	-
	7.4L	340 / 7.4L	GM		8	4		5889914 & sup	18-1334	18-1333	18-1332	18-1315	-	-	-
	5.7L	350 MAG ALPHA		350	8	4	1986-1997	A635178 - K999999	18-1308	18-1309	18-1341	18-1300	-	-	-
	5.7L	350	GM	350	8	4		3780450 & sup	18-1334	18-1333	18-1332	18-1315	-	-	-
	5.7L	350 MAG / 350 ALPHA / 350 EFI / 350 GEN +		350	8	4	1996-1997	F800300 - K999999	18-1308	-	-	-	-	-	-
	5.7L	350 MAG / 350 BRAVO / 350 MPI		350	8	4	1995	F415189 - F601999	18-1308	-	-	-	-	-	-
	5.7L	350 MAG / 350 BRAVO / 350MPI / 350 GEN +		350	8	4	1996-1997	F602000 - K999999	18-1308	-	-	-	-	-	-
	5.7L	350 MAG SKI		350	8	4	1994-1996	F215561 - F820706	18-1308	-	-	-	-	-	-
	5.7L	350 MAG EFI SKI GEN +		350	8	4	1996-1997	F820707 - K999999	18-1308	-	-	-	-	-	-
	5.7L	350 MAG MPI GEN +		350	8	4	1988-2010	L010019 & SUP	18-1308	-	-	-	-	-	-
	5.7L	350 MAG MPI / 350 MAG MIE GEN +		350	8	4	1998-2007	L002008 - A089999	18-1308	-	-	-	-	-	-
	5.7L	350MG / 350 MPI / 350 SKI		350	8	4	1995-1996	F350583 - F799999	18-1308	-	-	-	-	-	-
	5.7L	350 MAG / 350 MPI / 350 SKI / 350 GEN +		350	8	4	1998-2007	L002600 - A089999	18-1308	-	-	-	-	-	-
	5.7L	350 MAG SKI		350	8	4	1991-1997	D505450 - K999999	18-1308	-	-	-	-	-	-
	5.7L	5.7L		350	8	4	1988-1997	4908850 - F600999	18-1308	-	-	-	-	-	-
	5.7L	5.7L GEN +		350	8	4	1998-2010	L010037 & SUP	18-1308	-	-	-	-	-	-
	5.7L	5.7L EFI		350	8	4	1995-1997	F225560 - K999999	18-1308	-	-	-	-	-	-
	5.7L	5.7L EFI GEN +		350	8	4	1998-2001	L010035 - M2999999	18-1308	-	-	-	-	-	-
	5.7L	5.7L EFI MIE GEN +		350	8	8	1997	K040300 - K999999	18-1308	-	-	-	-	-	-
	5.7L	5.7L MIE		350	8	4	1988-1997	B788152 - K999999	18-1308	-	-	-	-	-	-
	5.7L	5.7L MIE GEN +		350	8	4	1998-2010	L002003 & SUP	18-1308	-	-	-	-	-	-
	5.7L	5.7L MPI / 5.7L MIE		350	8	4	2008-2010	A090000 & SUP	18-1308	-	-	-	-	-	-
	5.7L	5.7L MPI SKI		350	8	4	2008-2010	A090000 & SUP	18-1308	-	-	-	-	-	-
	5.7L	5.7L SKI		350	8	4	1985-1987	A338553 - K999999	18-1308	-	-	-	-	-	-
	5.7L	5.7L SKI GEN +		350	8	4	1998-2010	L002005 & SUP	18-1308	-	-	-	-	-	-
	5.7L	5.7LX		350	8	4	1996-1997	F601000 - F600999	18-1308	-	-	-	-	-	-
	5.7L	5.7LX / 5.7LX BRAVO / 5.7LX EFI / 5.7LX GEN +		350	8	4	1996-1997	F800300 - K999999	18-1308	-	-	-	-	-	-
	5.7L	5.7L EFI		350	8	4	1996-1997	F752400 - K999999	18-1308	-	-	-	-	-	-
	5.7L	BLACK SCORPION SKI GEN +		350	8	4	1996-2006	F800000 - W689999	18-1308	-	-	-	-	-	-
	5.7L	BLACK SCORPION SKI GEN +		350	8	4	2003-2007	W690000 - W698432	-	Ⓛ	Ⓛ	-	-	-	-
	5.7L	SCORPION 350		350	8	4	2008-2010	W698433 & SUP	-	Ⓛ	Ⓛ	-	-	-	-
		233		351	8	4	1975-1977	4173000 - 4902304	-	-	-	-	-	-	-
		255	FORD	351	8	4	1973-1974	3258728 - 4175499	-	-	-	-	-	-	-
		TOURNEY SKI			8	4		D505450 & sup	18-1308	18-1309	18-1341	18-1300	-	-	-
		370 TRS	GM		8	4		6721528 & sup	18-1334	18-1333	18-1332	18-1315	-	-	-
		377 MAG		377	8	4	2008-2010	A3000000 & SUP	-	Ⓛ	Ⓛ	-	-	-	-
		377 SCORPION MCM		377	8	4	1999-2005	L416145 - M907201	-	Ⓛ	Ⓛ	-	-	-	-
		377 SCORPION SKI GEN +		377	8	4	1997-1998	K000656 - L600314	-	Ⓛ	Ⓛ	-	-	-	-
	6.2L	MX 6.2L MPI		377	8	4	2000-2007	L680003 - A299999	-	Ⓛ	Ⓛ	-	-	-	-
	6.2L	MX 6.2L MPI / MX 6.2L HORIZON		377	8	4	2002-2007	M3000000 - A299999	-	Ⓛ	Ⓛ	-	-	-	-
	6.2L	MX 6.2L MPI / MX 6.2L HORIZON / MX 6.2L MIE		377	8	4	2002-2010	M3000000 & SUP	-	Ⓛ	Ⓛ	-	-	-	-
	6.2L	MX 6.2L MPI / MX 6.2L MIE		377	8	4	2002-2010	M3000000 & SUP	-	Ⓛ	Ⓛ	-	-	-	-
	6.2L	MX 6.2L BLACK SCORPION SKI		377	8	4	2002-2007	M300000 - W698432	-	Ⓛ	Ⓛ	-	-	-	-
	6.2L	SCORPION 377		377	8	4	2008-2010	W698433 & SUP	-	Ⓛ	Ⓛ	-	-	-	-
	7.4L	325		454	8	4	1969-1972	2278747 - 3780449	-	-	-	-	-	-	-
	7.4L	330		454	8	4	1977-1987	4623115 - B816540	-	-	-	-	-	-	-
	7.4L	330 MIE		454	8	4	1977-1980	4623115 - 5889913	-	-	-	-	-	-	-
	7.4L	340 MIE W/B-W		454	8	4	1981-1987	5889914 - B788365	-	-	-	-	-	-	-
	7.4L	350 MIE		454	8	4	1974-1976	3780450 - 4623109	-	-	-	-	-	-	-
	7.4L	370 TRS		454	8	4	1978-1987	4179554 - B714586	-	-	-	-	-	-	-
		390	GM		8	4		2781129 - 2825059	18-1334	18-1333	18-1332	18-1315	-	-	-
	7.4L	400 TRS		454	8	4	1980-1986	4179554 - B457644	-	-	-	-	-	-	-
	7.4L	420	GM	454	8	4	1987-1989	A398941 - B622418	18-1334	18-1333	18-1332	18-1315	-	-	-
	7.4L	425	GM	454	8	4	1990-1992	B622419 - D725499	-	-	-	18-1315	-	-	-
	7.4L	425 GEN V		454	8	4	1992-1993	D725500 - D937011	-	-	-	-	-	-	-
	7.4L	440 TRS		454	8	4	1983-1986	4179554 - B485220	-	-	-	-	-	-	-
	7.4L	450 GEN V		454	8	4	1995-1996	F347100 - F347277	-	-	-	-	-	-	-
	7.4L	454 MAG ALPHA	GM	454	8	4	1986-1988	A631894 - B785148	18-1334	18-1333	18-1332	18-1315	-	-	-
	7.4L	454 MAG BRAVO		454	8	4	1988-1992	B721206 - D805068	-	-	-	-	-	-	-
	7.4L	454 MAG BRAVO	GM	454	8	4		B840126 & SUP	18-1334	18-1333	18-1332	18-1315	-	-	-







Ⓛ 8 PAR CONJUNTO COJNETES

HP	Litro	Modelo	Nota	CID	# Cil	tiempos	Año	Número serie	COJINETE BIELA			COJINETE PRINCIPAL			COJINETE LEVA
									Std.	0.01	0.02	Std.	0.01	0.02	
7.4L	454	MAG BRAVO GEN V		454	8	4	1992-1996	D805069 - M801699	18-1334	18-1333	18-1332	18-1315	-	-	-
7.4L	454	MAG BRAVO GEN VI		454	8	4	1996-1997	F801700 - K999999	-	-	-	-	-	-	-
7.4L	454	MAG EFI GEN V		454	8	4	1994-1996	F115700 - F802349	-	-	-	-	-	-	-
7.4L	454	MAG EFI SKI GEN V		454	8	4	1995-1996	F215800 - F820099	-	-	-	-	-	-	-
7.4L	454	MAG MPI GEN VI		454	8	4	1996-2001	F802350 - M024999	-	-	-	-	-	-	-
7.4L	454	MAG MPI / 454 MAG HORIZON / 454 MAG MIE		454	8	4	1998-2001	L002200 - L674000	-	-	-	-	-	-	-
7.4L	454	MAG MPI / 454 MAG SKI GEN VI		454	8	4	1996-1997	F820100 - K999999	-	-	-	-	-	-	-
7.4L	454	EFI		454	8	4		F115700 & SUP	18-1334	18-1333	18-1332	18-1315	-	-	-
	502	MAG	GM		8	4		C878221 & sup	18-1334	18-1333	18-1332	18-1315	-	-	-
	502	MAG BRAVO GEN V			8	4		D824589 & sup	18-1334	18-1333	18-1332	18-1315	-	-	-
	502	MAG BRAVO GEN V			8	4		D840650 & sup	18-1334	18-1333	18-1332	18-1315	-	-	-
	502	EFI			8	4		3108723 & sup	18-1336	-	-	-	-	-	-
	525	SC		454	8	4	1991-1992	D456000 - D725808	-	-	-	-	-	-	-
	525	SC GEN V		454	8	4	1992-1996	D763746 - F745215	-	-	-	-	-	-	-
	525	SC GEN V		454	8	4	1996-1999	F745260 - L415623	-	-	-	-	-	-	-
7.4L	7.4L	BRAVO		454	8	4	1988-1991	B771113 - D603117	-	-	-	-	-	-	-
7.4L	7.4L	BRAVO GEN V		454	8	4	1992-1996	D603118 - F800699	-	-	-	-	-	-	-
7.4L	7.4L	BRAVO GEN VI		454	8	4	1996-1997	F800700 - K299999	-	-	-	-	-	-	-
7.4L	7.4L	EFI / 7.4L MIE GEN VI		454	8	4	1996-1997	F874815 - K999999	-	-	-	-	-	-	-
7.4L	7.4L	MIE		454	8	4	1988-1992	B788366 - D715493	-	-	-	-	-	-	-
7.4L	7.4L	MIE GEN V		454	8	4	1992-1996	D715494 - F820141	-	-	-	-	-	-	-
7.4L	7.4L	LH / 7.4L MIE GEN VI		454	8	4	1996-1997	F820142 - K999999	-	-	-	-	-	-	-
7.4L	7.4L	MPI GEN V		454	8	4	1998-2001	L010003 - M024330	-	-	-	-	-	-	-
7.4L	7.4L	MPI GEN V / 7.4L MIE GEN V		454	8	4	1995-1996	F563052 - F820103	-	-	-	-	-	-	-
7.4L	7.4L	MPI GEN VI / 7.4L MIE GEN VI		454	8	4	1996-1997	F820104 - K999999	-	-	-	-	-	-	-
7.4L	7.4L	MPI GEN VI L29 / 7.4L MIE GEN VI L29		454	8	4	1998-2001	L002006 - M025999	-	-	-	-	-	-	-
7.4L	7.4L	X BRAVO TBI GEN VI		454	8	4	1988-2001	F802000 - K999999	-	-	-	-	-	-	-
7.4L	7.4L	X BRAVO MPI GEN V		454	8	4	1996	F602010 - F801999	-	-	-	-	-	-	-
7.4L	7.4L	X BRAVO MPI GEN VI		454	8	4	1996-1997	F802000 - K999999	-	-	-	-	-	-	-
7.4L	7.4L	BRAVO	GM					D603118 & Sup	18-1334	18-1333	18-1332	18-1315	-	-	-
7.4L	7.4L	BRAVO GEN V						C391564 & Sup	18-1334	18-1333	18-1332	18-1315	-	-	-
7.4L	7.4L	W/HURTH						D715494 & Sup	18-1334	18-1333	18-1332	18-1315	-	-	-
7.4L	7.4L	HR GEN V						C878221 & Sup	18-1334	18-1333	18-1332	18-1315	-	-	-
	390			482	8	4	1969-1970	2781129 - 2825059	-	-	-	-	-	-	-
	460	TRS		482	8	4	1983-1986	4179554 - 6181046	-	①	①	-	-	-	-
	496	MAG / 496 HO		496	8	4	2001-2010	M025000 & SUP	-	-	-	-	-	-	-
	8.1S	MPI / 8.1S MIE / 8.1S HO		496	8	4	2001-2010	M025000 & SUP	-	-	-	-	-	-	-
8.2L	465			502	8	4	1990-1992	C849992 - D725646	-	-	-	-	-	-	-
8.2L	465	GEN V		502	8	4	1992-1994	D725647 - F213244	-	-	-	-	-	-	-
8.2L	500	GEN V		502	8	4	1994-1996	F213293 - F745159	-	-	-	-	-	-	-
8.2L	500	GEN VI		502	8	4	1997-1999	K745195 - L601036	-	-	-	-	-	-	-
8.2L	500	EFI		502	8	4	1999-2000	L001477 - L306499	-	-	-	-	-	-	-
8.2L	500	EFI		502	8	4	2000-2005	L306500 - M907127	-	-	-	-	-	-	-
8.2L	502	MAG BRAVO		502	8	4	1990-1992	C876221 - D824588	-	-	-	-	-	-	-
8.2L	502	MAG BRAVO GEN V		502	8	4	1992-1993	D824589 - F114528	-	-	-	-	-	-	-
8.2L	502	MAG EFI		502	8	4	1993-1996	D840650 - F802599	-	-	-	-	-	-	-
8.2L	502	MAG MPI GEN VI		502	8	4	1996-2001	F802600 - M024999	-	-	-	-	-	-	-
8.2L	525	EFI		502	8	4	2003-2007	M900146 - M958499	-	-	-	-	-	-	-
8.2L	525	EFI		502	8	4	2007-2010	M958500 & SUP	-	-	-	-	-	-	-
8.2L	575	SCi		502	8	4	20071-2005	L306696 - M950526	-	-	-	-	-	-	-
8.2L	600	SC		502	8	4	1991-1992	D456489 - D456768	-	-	-	-	-	-	-
8.2L	600	SC GEN V		502	8	4	1992-1996	D725676 - F877642	-	-	-	-	-	-	-
8.2L	600	SC GEN VI		502	8	4	1997-2000	K000227 - L601186	-	-	-	-	-	-	-
8.2L	8.2L	MAG		502	8	4	2010	A350340 & SUP	-	-	-	-	-	-	-
8.2L	8.2L	MIE		502	8	4	2010	A350802 & SUP	-	-	-	-	-	-	-
8.2L	8.2L	MIE W/HURTH		502	8	4	1990-1992	C878221 - D857199	-	-	-	-	-	-	-
8.2L	8.2L	W/HURTH (IB)		502	8	4		D857200 & Sup	18-1334	18-1333	18-1332	18-1315	-	-	-
8.2L	8.2L	MIE GEN V		502	8	4		D857200 - F819619	-	-	-	-	-	-	-
8.2L	8.2L	MPI GEN VI / 8.2L MIE GEN VI / 8.2LH GEN VI		502	8	4	1996-2001	F819620 - L674200	-	-	-	-	-	-	-
	500	BULLDOG		540	8	4	1990-1996	C577254 - F745405	-	①	①	-	-	-	-
	500	BULLDOG		540	8	4	1997-2001	K000248 - M050281	-	①	①	-	-	-	-
	575			540	8	4	1986-1992	A677429 - D763716	-	①	①	-	-	-	-
	800	SC GEN V		540	8	4	1993-1998	D763836 & SUP	-	①	-	-	-	-	-
	888		FORD		8	4		4762210 & Sup	18-1308	18-1309	18-1341	18-1300	-	-	-
	898 / 198		GM					A338553 & sup	18-1308	18-1309	18-1341	18-1300	-	-	-

① 8 PAR CONJUNTO COJINETES

MERCURISER 3.7L APLICACIÓN COJINETES

Modelo	Número serie	COJINETE BIELA			COJINETE PRINCIPAL			PRINCIPAL (COJINETE EMPUJE)		
		Std.	.010	.020	Std.	.010	.020	Std.	.010	.020
165\3.7 (4cil)	6916779 & Sup	18-1148	-	-	-	-	-	18-1149	-	-
170 (4cil)	6916779 & Sup	18-1148	-	-	-	-	-	18-1149	-	-
180\3.7L (4cil)	6916779 & Sup	18-1148	-	-	-	-	-	18-1149	-	-
190 (4cil)	6916779 & Sup	18-1148	-	-	-	-	-	18-1149	-	-
470	4208730 & Sup	18-1148	-	-	-	-	-	18-1149	-	-
485	5685394 & Sup	18-1148	-	-	-	-	-	18-1149	-	-
488	6170297 & Sup	18-1148	-	-	-	-	-	18-1149	-	-

 <p>18-0518 RETÉN VÁLVULA Reemplaza: 26-34217, 26-72564, 26-58094, 26-75413, 26-75624</p>	 <p>18-4023 RETÉN VÁLVULA Reemplaza: 26-75413, 26-75624, 26-72564, 26-58094 Para: 165, 170, 180, 190 4 cil. (224 CID) SN 6916779 y posteriores</p>	 <p>18-4022 RETÉN VÁLVULA Reemplaza: 26-75988, 26-75982, 26-67863, 26-49131, F3866612, FI1100968, FI1101117 Para: 330 (SN 4623115 & posteriores), 340 (IB) (SN 5889914 & posteriores), 454 Mag (SN A631894 & posteriores)</p>	 <p>Pack. de 8</p> <p>18-4024 18-4024-9^② RETÉN VÁLVULA Reemplaza: 26-97664, 26-976641 26-8M0050563, FI1101200</p>
 <p>RETENES CIGÜEÑAL 1 PIEZA 18-1234 Reemplaza: 24-811554, 24-17057A1, 24-801879, 24-801879T Para: 7.4L, GL, GI, GSI: 8.2L, GL</p> <p>18-0519 Reemplaza: 26-14240, FI1101300 4.3L/3.0L/5.0L 5.7L</p> <p>18-0864 Reemplaza: 26-90925, 27-67389</p>	 <p>RETENES CIGÜEÑAL 2 PIEZAS</p> <p>18-0528 Reemplaza: 26-56868</p> <p>18-1211 Reemplaza: 26-58203, 26-49947, 26-814622, FI110026, FI110027, FI110041</p>	 <p>RETENES TAPA DISTRIBUCIÓN</p> <p>18-1213 Reemplaza: 97355, 79223, 59341, 59341A1, FI1100622, FI1101014</p> <p>18-1233 Reemplaza: 26-8219471, 26-821947, 26-49154, FI1100986</p> <p>18-0578 Reemplaza: 26-67388</p>	

APLICACIONES RETENES MERCURUISER

Modelo	Número serie	Retén Principal Trasero	Retén Tapa distribución
120/2.5L	1666601 & SUP	—	18-1213
120/2.5L	2786857 & SUP	18-1211	18-1213
140/3.0L & LX	2508261 & SUP	—	18-1213
140/3.0L & LX	6229718 & SUP	18-1211	18-1213
150/160/165/200 (I/L-6)	1666495 & SUP	—	18-1213
150/160/165/200 (I/L-6)	2770032 & SUP	18-1211	18-1213
175/185/205/262/4.3L (V-6)	6330183 & SUP	18-1211	18-1213
200/228/225/230/250/255/260/270			
280/300/320/5.0L/5.7L/898(V-8)	2453769 & SUP	18-1211 ^①	18-1213
215	2781153 & SUP	18-0528	—
224I/L4	TODOS	18-0864	18-0578
225 FORD	3885721 & SUP	18-0528	—
5.0L/5.7L, 4.3L, 3.0L Rotación Std.	“Todos” Retén una pieza	18-0519	18-1213
340 (7.4L)	4623115 & SUP	—	18-1233
370 TRS	5889914 & SUP	—	18-1233
400 TRS	4179554 & SUP	—	18-1233
420	A398941 & SUP	—	18-1233
440 TRS	4179554 & SUP	—	18-1233
454 MAGNUM	A631894 & SUP	—	18-1233
460 TRS	4179554 & SUP	—	18-1233
7.4L/8.2L/454/502 Rotación Std.	“Todos” Retén una pieza	18-1234	18-1233
7.4 BRAVO	B771113 & SUP	—	18-1233
888 (188)	3108723 & SUP	18-0528	—

^① Cigüeñal largo motores GM

^② Precio por envase



JUNTAS Y KITS PARA CODOS Y COLECTORES



18-0403
KIT JUNTAS DE ADMISIÓN
 Reemplaza: 27-805722A1, 27-812712, 27-61782, 27-52571
 Para: Motores MCM 370, 400, 325, 454, 502 Mag, 7.4L Bravo II & MIE 8.2L1978-1997



18-0404
KIT JUNTAS DE ADMISIÓN
 Reemplaza: 27-805403A1
 Para: MCM/MIE 454 Mag MPI, 7.4L/LX MPI & 8.2L MPI 1993-SUP



18-0603
JUEGO DE JUNTAS COLECTOR DE ESCAPE
 Para: Motores Ford 302/351 CID
 Para usar con 18-1998-1

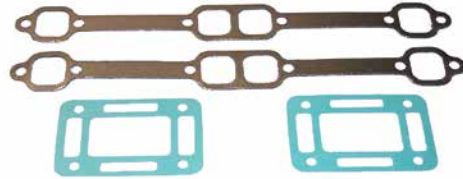

18-0604
JUEGO DE JUNTAS COLECTOR DE ESCAPE
 Para: Motores GM 305/350 CID
 Para usar con 18-1997-1



18-4347-1
JUEGO DE JUNTAS COLECTOR ESCAPE
 Para: GM 175, 185, 205 (229 & 262 CID)



18-4348
JUEGO DE JUNTAS COLECTOR DE ESCAPE
 Para: GM 454, 525 (7.4L & 8.2L)

-- CONTIENE --

Ref #	Descripción	O.E. #	Cant.
18-0897	Junta codo escape	27-41813-1	2
18-2909	Junta colector escape	27-99757	2

-- CONTIENE --

Ref #	Descripción	O.E. #	Cant.
18-0418	Junta	27-48820	2
18-0897	Junta codo escape	27-41813-1	2



18-4408
JUEGO DE JUNTAS COLECTOR DE ADMISIÓN
 Reemplaza: 27-11977, 27-11987
 Para: Motores GM 262 CID 175, 185 y 205 HP



18-4349
JUEGO DE JUNTAS COLECTOR DE ESCAPE
 Para: GM 200, 228, 230, 260, 898 (5.0 & 5.7L)

-- CONTIENE --

Ref #	Descripción	O.E. #	Cant.
18-2949	Junta colector escape	27-33395	2
18-0897	Junta codo escape	27-41813-1	2



18-4367
JUEGO DE JUNTAS COLECTOR DE ESCAPE
 Reemplaza: 27-99777A1
 Para: Motores GM 153 & 181 (2.5 & 3.0L) CID ; 120 & 140 HP S/N 6229718 & SUP
 (Con culatas babor siamesas)

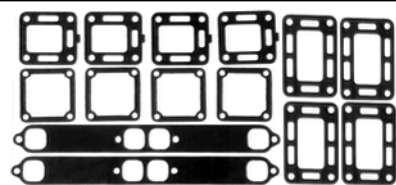

18-4394
JUEGO JUNTAS COLECTOR ESC.
 Reemplaza: 27-33395A2, 27-33395A1
 Para: GM 350 (5.7L) CID Eng; 250 HP S/N 4768000-4908849 255 HP S/N 5195909 & sup

-- CONTIENE --

Ref #	Descripción	O.E. #	Cant.
18-2832-1	Junta tapa colector	27-48043	4
18-2833	Junta codo escape	27-99777-2	4
18-2949	Junta colector escape	27-33395	2
18-0885-1	Junta codo escape	27-48042	4

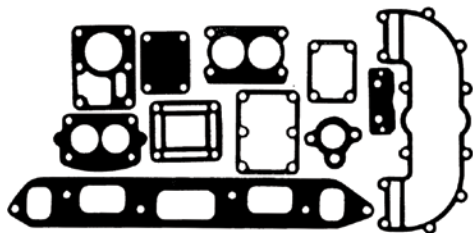

18-4395
JUEGO DE JUNTAS COLECTOR ESCAPE
 Reemplaza: 27-35898A4, 27-35898A3, 27-35898A2
 Para: GM 153 (2.5L) CID;
 120 HP S/N 2046625-6229717

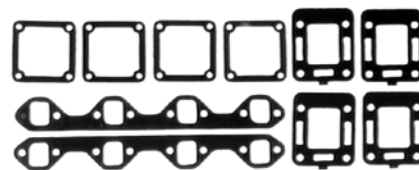

18-4399
JUEGO DE JUNTAS COLECTOR ESCAPE
 Reemplaza: 27-54566A1
 Para: motores Ford 302/351 (5.0L & 5.8L) CID; Todos 888 (188 HP)
 & 233 HP, 255 HP S/N 3258728-4175498
 – CONTIENE –

Ref #	Descripción	O.E. #	Cant.
18-0183-1	Junta escape	27-46820	2
18-2832-1	Junta tapa lateral colector	27-48043-1	4
18-2833	Codo escape junta	27-99777-2	4

18-4396
JUEGO DE JUNTAS COLECTOR DE ESCAPE
 Reemplaza: 27-46401A1
 Para: Motores 250 (4.1L) CID; 165 HP S/N 2770032 & SUP
 – CONTIENE –

Ref #	Descripción	O.E. #	Cant.
18-2830-1	Junta colector	27-46401	1
18-2831	Junta termostato	27-47590-1	1
18-2832-1	Junta tapa lateral colector	27-48083-1	2
18-2833	Junta codo escape	27-99777-2	1
18-0353	Junta	27-58764	1
18-0356	Junta	27-64692	1
18-0928-1	Junta tapa lateral	27-73814	1

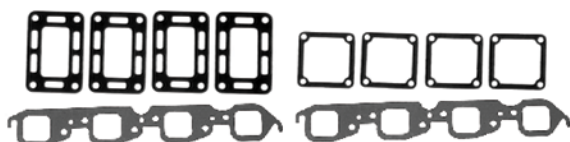
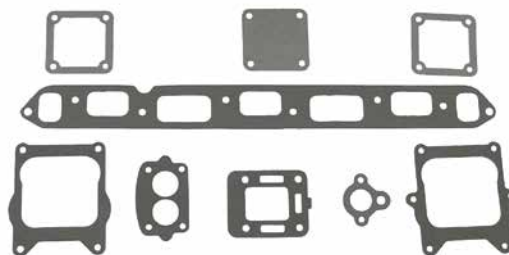

18-4397
JUEGO DE JUNTAS COLECTOR DE ESCAPE
 Reemplaza: 27-46820A1
 Para: Motores GM 454 (7.4L) CID; Todos 325, 350, 400 HP Jet Drives 330 HP S/N 6083144 & post
 – CONTIENE –

Ref #	Descripción	O.E. #	Cant.
18-0418	Junta escape	27-46820	2
18-0885-1	Junta codo escape	27-48042	4
18-2832-1	Junta tapa lateral colector	27-48043-1	4

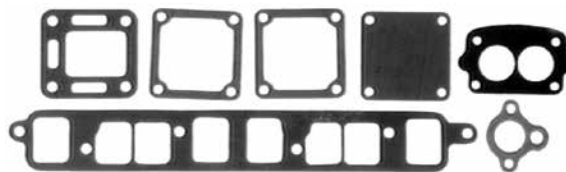

18-4398
JUEGO DE JUNTAS COLECTOR DE ESCAPE
 Reemplaza: 27-53354A1
 Para: Motores GM 181 (3.0L) CID; 140 HP S/N 3332137-6229717
 (Sin cilindro de babor siames)

JUEGOS JUNTAS CULATA Y COLECTOR ADMISIÓN

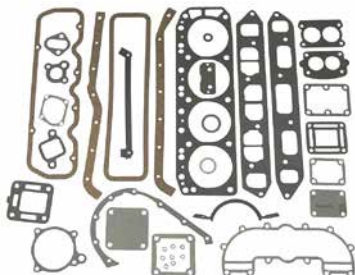

18-4383
 Para: Motores GM 153 (2.5L) CID;
 S/N 2324347 & SUP Incluye juntas culata 18-3880

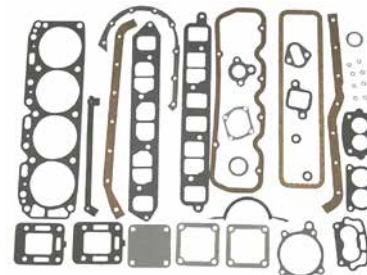

18-4384
 Para: Motores GM 181 (3.0L) CID;
 S/N 2508261-6229717 (Excepto 3.0LX)

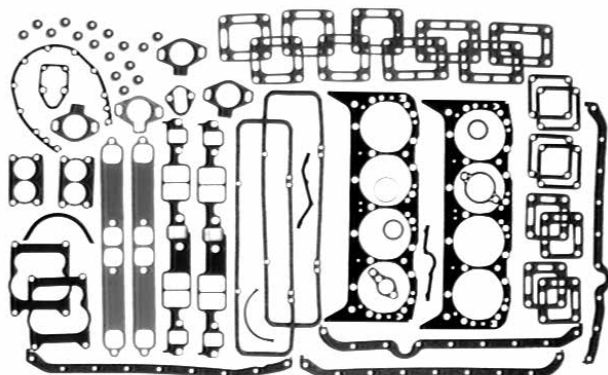

18-4386
 Para: Motores GM 305 & 350 (5.0L & 5.7L) CID; Con culatas (1987 & anteriores)

– CONTIENE –

Ref #	Descripción	O.E. #	Cant.
18-0976	Junta tapa	27-14250	1
18-0868	Junta entrada colector	27-17145	1
18-2949	Junta colector escape	27-33395	2
18-0897	Junta codo escape	27-41813	2
18-0885-1	Junta codo escape	27-48042	4
18-2917	Junta alojamiento termostato	27-53045-1	1
18-0153	Junta	27-85817A1	1
18-2848	Base quadrajete junta carburador	27-58457-2	2
18-2849-1	Junta codo escape	27-87105-1, 27-818832	4
18-3876	Junta culata	27-75611	2
18-2554	Junta termostato	27-41812	1
18-2832-1	Junta tapa lateral colector	27-48043-1	4
18-2553	Junta termostato	27-47510	1
18-2833	Junta colector	27-99777-2	4
18-2844	Junta tapa termostato	27-48818-1	1
18-0889	Junta alojamiento bomba de agua	27-34213	1
18-0891	Junta bomba agua	27-34897	1
18-0905	Junta tapón	27-49955	1
18-0876	Junta bomba agua	27-34898	1
18-0994	Junta	27-70143-1	2
18-0518	Retén	26-34217	16
18-2845	Junta tapa válvula	121-122	2

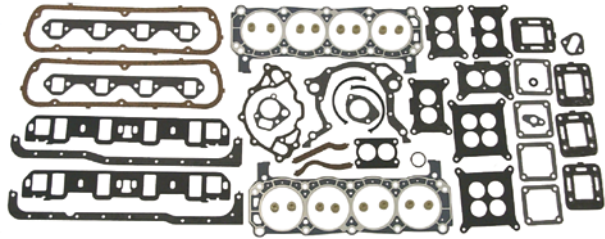

18-4385
 Para: Motores Ford 302 (5.0L) CID; 215, 225 & 888 (188 HP)
 Incluye junta culata 18-3883

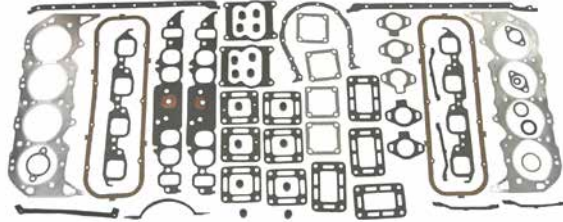

18-4387
 Reemplaza: 27-801853
 Para: Motores GM 454 (7.4L) CID; Salida oval
 Incluye junta culata 18-3877

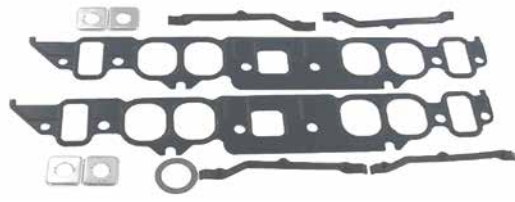

18-0465
JUEGO JUNTAS COLECTOR ADMISIÓN
 Reemplaza: 27-65184, 27-8M0050224
 Para: motores GM 454 CID, 325, 330, 340, 350 HP
 y 454 Magnums, 7.4L

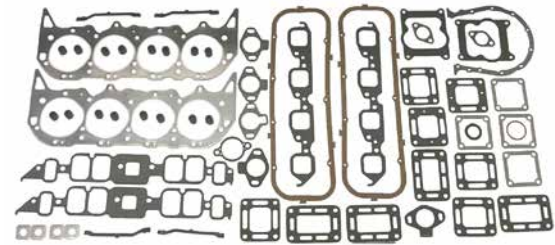

18-4365
JUEGO DE JUNTAS COLECTOR DE ESCAPE
 Reemplaza: 27-801855
 Para: motores GM 454 (7.4L) CID; Modelos salida rectangular
 Incluye junta culata 18-3877

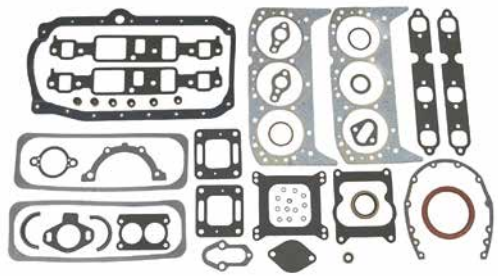

18-4388
JUEGO JUNTAS COMPLETO
 Reemplaza: 27-11977A88, A92
 Para: motores GM 262 CID; 175, 185 & 205 HP, 4.3L
 Incluye junta culata 18-3879

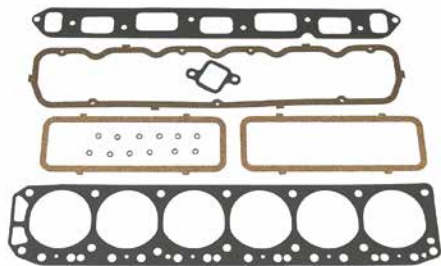

18-4389
JUEGO DE JUNTAS COLECTOR ADMISIÓN
 Reemplaza: 27-47453A1
 Para: Todos GM 165 HP (S/N 270032 & SUP) & En línea 6 cil.
 250 CID

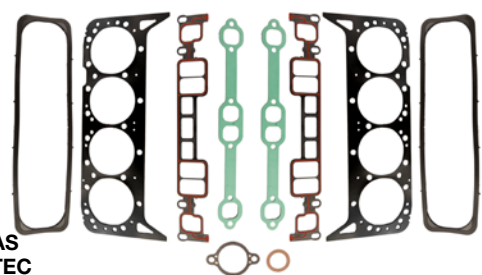

18-1254
JUEGO JUNTAS CULATA VORTEC
 Reemplaza: 27-75611A03
 Para: Motores bloques pequeños GM
 V8 con Vortec.

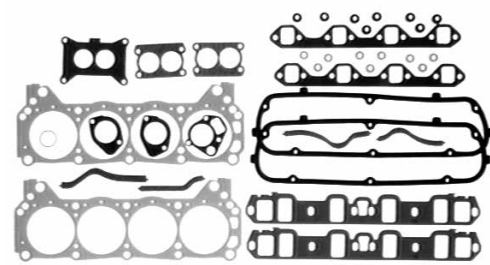

18-4391
JUEGO JUNTAS COLECTOR ADMISIÓN
 Reemplaza: 27-64763A2
 Para: Motores Ford 351 CID; 233 HP S/N 4173000-4500860, 5.8L
 Incluye junta culata 18-3883

18-4392
JUEGO JUNTAS COLECTOR ADMISIÓN
 Reemplaza: 27-75611A2, 27-75611A1
 Para: motores GM 305 & 350 CID, 898 (198 HP) 200, 228,
 230/260 (Intraborda) 230, 250, 255, 260, 280 & 5.7L Ski

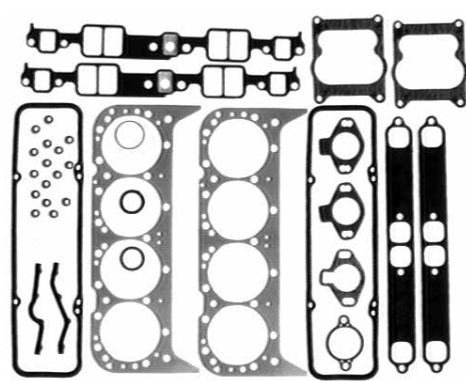

— CONTIENE —

Ref #	Descripción	O.E. #	Cant.
18-0868	Junta entrada colector	27-17145	1
18-2949	Junta colector escape	27-33395	2
18-2848	Base quadrajet junta carburador	27-52457-2	2
18-3876	Junta culata	27-75611	2
18-2553	Junta termostato	27-47510	1
18-2844	Junta tapa termostato	27-48818-1	1
18-2554	Junta termostato	27-41812	2
18-2917	Junta alojamiento termostato	27-53045-1	1
18-2845	Junta tapa válvula	27-11999	2
18-0518	Retén	26-34217	16

KITS JUNTAS

(Los juegos de juntas no incluyen los retenes de cigüeñal)

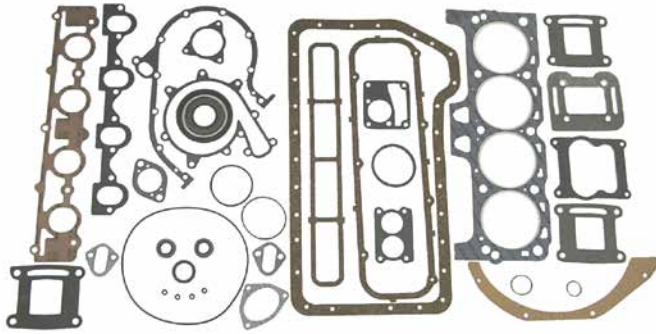

18-4381

Reemplaza: 27-43186A1, 27-89656A1, 27-41636A1
 Para: Motores 224 (3.7L) CID ; 165, 170, 180, 190 HP
 S/N 6916779 & SUP

-- CONTIENE --			
Ref #	Descripción	O.E. #	Cant.
18-0175	Aro	25-26543	4
18-0860	Aro	25-62700	1
18-0864	Retén	26-90925	1
18-0881-1	Junta codo escape	27-18272	1
18-0992	Junta escape	27-68715	1
18-0994	Junta montaje carburador	27-70143-1	1
18-0158	Junta entrada colector	27-70905	1
18-0111	Junta codo escape	27-89657	2
18-0160	Junta escape colector	27-94136	1
18-0113-1	Junta codo escape	27-97542	1
18-2843	Junta tapa termostato	27-74830	1
18-2848	Junta base quadrajete	27-52457-2	1
18-3878	Junta culata	27-13709T	1
18-7121	Aro	25-35027	1
18-0874	Junta distribuidor	27-34486	1
18-0185	Retén	27-91892	1
18-2555	Junta termostato	27-89656-1	1
18-0889	Junta bomba combustible	27-34213	1
18-4366	Juego de juntas	27-72479A5	1
18-0387	Junta tapa volante	27-94976	1
18-0172	Retén aceite	26-97530	2

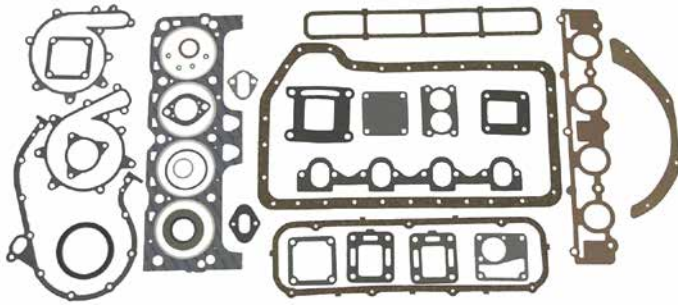

18-4382

Reemplaza: 27-74830A3, 27-74830A1, 27-74264A1
 Para: Motores 224 (3.7L) CID; 470 S/N 4208730 & SUP

-- CONTIENE --			
Ref #	Descripción	O.E. #	Cant.
18-0864	Retén	26-90925	1
18-0956-1	Junta montaje colector escape	27-68715	1
18-0158	Junta entrada colector	27-70905	1
18-0950	Junta tapa impulsor	27-88046	1
18-0954	Junta montaje escape	27-92720	1
18-0113-1	Junta montaje codo escape	27-97542	1
18-2832-1	Junta tapa lateral colector	27-48043-1	2
18-2833	Junta codo	27-99777-2	2
18-2843	Junta tapa termostato	27-74830	1
18-3878	Junta culata	27-13709T	1
18-0175	Aro	25-26543	4
18-0889	Junta montaje bomba combustible	27-34213	1
18-7121	Aro	25-35029	1
18-0874	Junta distribuidor	27-34486-3	1
18-0928-1	Junta tapa lateral colector	27-73814	1
18-0994	Junta montaje carburador	27-70143-1	1
18-2555	Junta tapa termostato	27-89656-1	1
18-4366	Juego de juntas carter	27-72479A5	1
18-0387	Juntas tapa volante	27-94976	1

JUEGO DE JUNTAS VARIOS

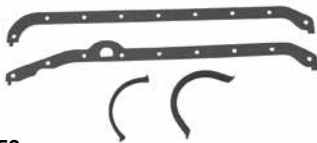

18-0153

JUEGO DE JUNTAS CARTER
 Reemplaza: 27-85817A1, FI5110037, FI5110032, 27-72627
 Para: Mercruiser GM 350 CID (5.7L)



18-0340

JUEGO DE JUNTAS CARTER
 Reemplaza: 27-49949, 27-34207
 Para: Mercruiser 160/165 (6 cil.)



18-1239

JUNTA CARTER
 Reemplaza: 27-810846T, 27-810846
 Para: Mercruiser 3.0L GM 181



18-0348

JUEGO DE JUNTAS CARTER
 Reemplaza: 27-52550, 27-49107, FI1100229, FI5000229, FI5000245
 Para: Motores Mercruiser GM 454/502 CID; (7.4L y 8.2L)



18-1237

JUNTA CARTER
 Reemplaza: 27-138651, 27-13865, FI1101281
 Para: Mercruiser GM 5.7L



18-0466

JUEGO DE JUNTAS CARTER
 Reemplaza: 27-14901A1, 27-14901, 27-52144
 Para: Mercruiser GM 153/181 (2.5L & 3.0L)



18-1232

JUNTA CARTER
 Reemplaza: 27-811566, 27-845628
 Para: GM bloque grande



18-1231

JUNTA ADMISIÓN
 Reemplaza: 27-8181881, 27-818188
 Para: Salida rectangular y bloque alto rendimiento Chevy



18-0405

JUNTA CARTER
 Reemplaza: 27-14247-1, 27-883964, 27-14247, 27-883964, 27-883964T
 Para: motores Mercruiser GM 262 CID. (4.3L)



18-1238
JUEGO DE JUNTAS ADMISIÓN
 Reemplaza: 27-824326
 Para: Mercruiser 4.3L/LX modelos, pre SN F802999



18-61513
JUNTA CARTER
 Reemplaza: 27-14247T1, 27-142471
 Para: Mercruiser MCM 262 Mag & 4.3L/LX/LH/LHX Gen+ (1996 & sup); Todos GM V6 (1996 & sup)



18-0407
JUEGO JUNTAS CARTER
 Reemplaza: 27-64798, 27-56870A1
 Para: Mercruiser: 215, 225, 888



18-0410
JUEGO JUNTAS COLECTOR DE ADMISIÓN
 Reemplaza: 27-75648
 Para: motores Ford 5.0L/302, 5.8L/351 CID; (233HP) S/N 3108723 & SUP



18-0411
JUEGO JUNTAS CARTER
 Reemplaza: 27-90458A1, 27-90458, FI5000178, FI5000183
 Para: Mercruiser GM 350 CID (5.7L) Varilla estribor



18-0611
JUEGO JUNTAS CARTER
 Reemplaza: 27-75483
 Para: motores Mercruiser Ford 351 CID



18-0868
JUEGO JUNTAS COLECTOR ADMISIÓN
 Reemplaza: 27-17145, 27-72637, FI5000263, FI5000232, FI1101296
 Para: Mercruiser 305, 350

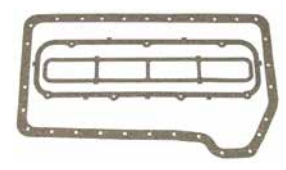

18-4366
JUEGO DE JUNTAS CARTER
 Reemplaza: 27-72479A5, 27-72479T, 27-72479
 Para: Mercruiser 224 CID (3.7L)

18-4375
KIT DE JUNTAS CADENA DISTR.
 Reemplaza: 27-34213A2, 27-34213A1
 Para: motores Mercruiser GM 153 & 181 CID; 110, 120, 130, 140, 150, 160 & 165 HP; 2.5L & 3.0L

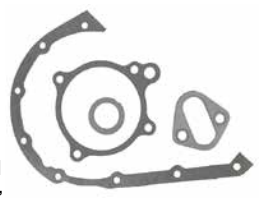

— CONTIENE —

Ref #	Descripción	O.E. #	Cant.
18-0889	Junta bomba combustible	27-34213	1
18-0887	Junta tapa distribución	27-49953	1
18-0948	Junta distribuidor	27-87707	1
18-0327	Junta bomba agua	27-33956	1

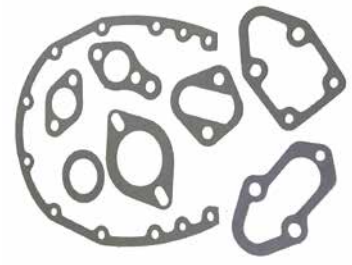

18-4377
KITS JUNTAS CADENA DISTRIBUCIÓN
 Reemplaza: 27-42457A1
 Para: Motores GM 262 CID; 175, 185 & 205 HP

18-4378
KIT DE JUNTAS CADENA DISTRIBUIDOR
 Reemplaza: 27-54529A1
 Para: motores GM 454 CID 325, 330, 340 & 350 Intraborda & 300TRS



— CONTIENE —

Ref #	Descripción	O.E. #	Cant.
18-0889	Junta bomba combustible	27-34213	1
18-0903	Junta bomba de agua	27-49110	2
18-0980	Junta tapa distribución	27-54529	1

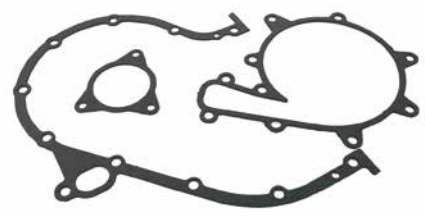



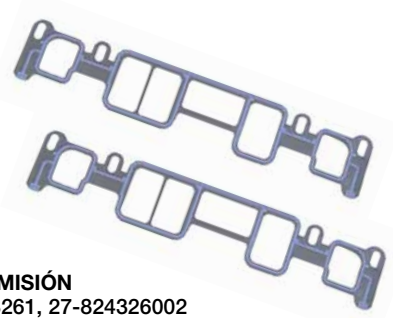



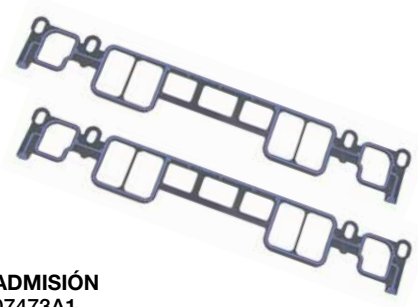



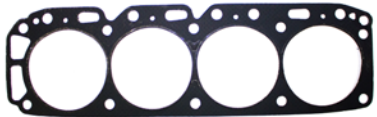





18-4380
KIT DE JUNTAS CADENA DISTRIBUCIÓN
 Reemplaza: 27-68714A6, 27-68714A7, 27-68714, 27-72098
 Para: Motores Mercruiser 224 CID, 165, 170, 180, 190, 470, 485 & 488 HP





18-0487
JUEGO JUNTAS ADMISIÓN
 Reemplaza: 27-8243261, 27-824326002
 Para: MCM 262 Mag & 4.3L/LX/LH/LHX Gen II (1996-sup)

















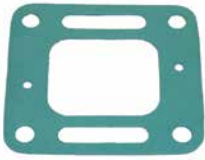

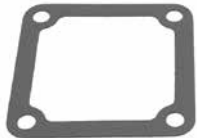

18-0488
JUEGO JUNTAS ADMISIÓN
 Reemplaza: 27-807473A1
 Para: MCM 350 Mag, 5.0L & 5.7L/LX Gen II (1996-sup)



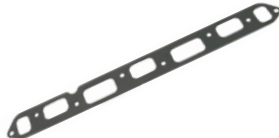

 <p>18-2946 JUNTA CULATA Reemplaza: 27-52364, 27-81084, FI5000204 Para: motores GM 181 (3.0L) CID.</p>	 <p>18-3874 JUNTA CULATA Reemplaza: 27-811546, 27-879150139 Para: (8.2L) 502 CID</p>	 <p>18-3876 JUNTA CULATA Reemplaza: 27-75611, 27-75611001, 27-48330, 27-34278 Para: motores GM 305 (5.0L)/350 (5.7L) CID.</p>	
 <p>18-3877 JUNTA CULATA Reemplaza: 27-13218, 27-13687, 27-19315, 27-49104, 27-61224, 27-97529, 27-8M0049045 Para: motores GM 454 (7.4L) CID., Mark IV (pre-1992)</p>	 <p>18-3878 JUNTA CULATA Reemplaza: 27-13709, 27-13709T, 27-74264, 27-79986, 27-92166, 27-922661 Para: Motores Mercruiser 224 (3.7L) CID. Modelo 470</p>	 <p>18-3879 JUNTA CULATA Reemplaza: 27-11986, 27-816460, 27-879150140, 27-42744 Para: motores GM 262 (4.3L) CID.</p>	
 <p>18-3880 JUNTA CULATA Reemplaza: 27-34273, 27-810841, 27-342731 27-52364 Para: motores GM 153 (2.5L), (3.0L) CID.</p>	 <p>18-3881 JUNTA CULATA Reemplaza: 27-47453, 27-72622, 27-39164, 27-34274 Para: motores GM 250 (4.1L) CID (6 cil.)</p>	 <p>18-3883 JUNTA CULATA Reemplaza: 27-75647, 27-75646, 27-64763, 27-56110 Para: motores Ford 302 (5.0L) 351 (5.8L) CID.</p>	
 <p>18-3887 JUNTA CULATA Reemplaza: 27-850470, 27-879150141, 27-811547 Para: (7.4L) 454 CID GEN V y VI (1992-sup)</p>	 <p>18-0353 JUNTA MONTAJE CARBURADOR Reemplaza: 27-58764</p>	 <p>18-0354 JUNTA MONTAJE CARBURADOR Reemplaza: 27-60715</p>	 <p>18-0685 JUNTA TAPA VÁLVULA Reemplaza: 27-73666 224 CID (3.7L)</p>
 <p>18-0356 JUNTA MONTAJE CARBURADOR (Para Rochester) Reemplaza: 27-64692, 27-32910</p>	 <p>18-0357 JUNTA MONTAJE CARBURADOR Reemplaza: 27-65577, 27-56884</p>	 <p>Pack. de 2 18-0876 18-0876-9① JUNTA BOMBA COMBUSTIBLE Para GM 4.3L, 5.0L & 5.7L Reemplaza: 27-34898, FI5005756</p>	 <p>Pack. de 2 18-0889 18-0889-9① JUNTA BOMBA COMBUSTIBLE Para GM 4.3L, 5.0L & 5.7L Reemplaza: 27-34213, 27-56883, FI5005756</p>





① Precio por pack

 <p>18-0360 JUNTAS MONTAJE CARBURADOR Reemplaza: 27-70142</p>	 <p>18-0462 JUNTA MONTAJE CARBURADOR Reemplaza: 27-48399</p> <table border="1"> <thead> <tr> <th>Modelo</th> <th>Año</th> <th>S/N</th> </tr> </thead> <tbody> <tr> <td>250</td> <td>1968-69</td> <td>2314301-2639854</td> </tr> <tr> <td>270</td> <td>1969-72</td> <td>2851074-3385720</td> </tr> <tr> <td>325</td> <td>1969-70</td> <td>2278747-3042730</td> </tr> <tr> <td>390</td> <td>1969-70</td> <td>2781129-3042731</td> </tr> </tbody> </table>	Modelo	Año	S/N	250	1968-69	2314301-2639854	270	1969-72	2851074-3385720	325	1969-70	2278747-3042730	390	1969-70	2781129-3042731	 <p>18-0463 JUNTA MONTAJE CARBURADOR (Para Weber) Reemplaza: 27-814210</p>	 <p>18-0467 JUNTA MONTAJE CARBURADOR (Para Weber) Reemplaza: 27-41610, 27-49814</p>
Modelo	Año	S/N																
250	1968-69	2314301-2639854																
270	1969-72	2851074-3385720																
325	1969-70	2278747-3042730																
390	1969-70	2781129-3042731																
<p>Pack de 2</p>  <p>18-0994 18-0994-9^① JUNTA MONTAJE CARB Reemplaza: 27-701431, 27-8079821, 27-807982, 27-70143, 27-807982B, 27-70143B1</p>	<p>Pack de 2</p>  <p>18-2848 18-2848-9^① JUNTA BASE CARBURADOR Reemplaza: 27-524572, 18-52457, 18-524571</p>	<p>Pack. de 2</p>  <p>18-0874 18-0874-9^① JUNTA DISTRIBUIDOR Para GM V6 & V8 Reemplaza: 27-344863, 27-344861, 27-34486, 27-52184, 27-34891, F15000162, F3932344 Para: 2.6L (1989), 3.5L (1989), 4.3L (1987-93), 5.0L (1987-88), 5.7L (1987-92), 7.4L (1988-93), 8.2L (1992-93)</p>	<p>Pack de 2</p>  <p>18-0948 18-0948-9^① JUNTA DISTRIBUIDOR Reemplaza: 27-87707 4 Cil.</p>															
<p>Pack de 2</p>  <p>18-2552 18-2552-9^① JUNTA TERMOSTATO Reemplaza: 27-331792, 27-331791</p>	<p>Pack de 2</p>  <p>18-0667 18-0667-9^① JUNTA TAPA CONECTOR Reemplaza: 27-995061, 27-99506</p>	<p>Pack. de 2</p>  <p>18-2553 18-2553-9^① JUNTA TERMOSTATO Reemplaza: 27-47510, 27-47510Q GM V-6, V-8</p>																
<p>Pack. de 2</p>  <p>18-2554 18-2554-9^① JUNTA TERMOSTATO Reemplaza: 27-41812, 27-90556, 27-41812Q V-6 & V-8</p>	<p>Pack. de 2</p>  <p>18-2555 18-2555-9^① JUNTA TERMOSTATO Reemplaza: 27-896561, 27-89656 4 Cil.</p>	<p>Pack de 2</p>  <p>18-2831 18-2831-9^① JUNTA TERMOSTATO Reemplaza: 27-475901, 27-47590 4 & 6 Cil.</p>	<p>Pack de 2</p>  <p>18-2834 18-2834-9^① JUNTA TERMOSTATO Reemplaza: 27-60208 Ford V-8</p>															
<p>Pack de 2</p>  <p>18-2843 18-2843-9^① JUNTA TERMOSTATO Reemplaza: 27-74830 470</p>	<p>Pack de 2</p>  <p>18-2844 18-2844-9^① JUNTA TERMOSTATO Reemplaza: 27-48818, 27-488181, 27-48818Q1 V-8</p>	<p>Pack de 2</p>  <p>18-2917 18-2917-9^① JUNTA TERMOSTATO Reemplaza: 27-53045, 27-530451, 27-33179, F10077105, F11101276, F11101291, F15000096</p>	<p>Pack de 2</p>  <p>18-0398 18-0398-9^① JUNTA TERMOSTATO Replaces: 27-8M2021920, 27-33918</p>															



 <p>18-0111 JUNTA CODO ESCAPE Reemplaza: 27-89657</p>	 <p>18-0113-1 JUNTA CODO ESCAPE Reemplaza: 27-97542, 27-856705</p>	<p>Pack de 2</p>  <p>18-0672 18-0672-9① JUNTA CODO ESCAPE Reemplaza: 27-860231, 8637251</p>	 <p>18-0365 JUNTA INTERCAMBIADOR 2 3/4" dia. Reemplaza: 27-75450 224 CID</p>
 <p>18-0389 JUNTA INTERCAMBIADOR 3 15/16" dia. Reemplaza: 27-99960</p>	 <p>18-0881-1 JUNTA CODO ESCAPE Reemplaza: 27-18272</p>	<p>Pack. de 2</p>  <p>18-0885-1 18-0885-9① JUNTA CODO ESCAPE Reemplaza: 27-48042</p>	 <p>18-0897 JUNTA CODO ESCAPE Reemplaza: 27-41813</p>
<p>Pack de 2</p>  <p>18-0928-1 18-0928-9① JUNTA COLECTOR Reemplaza: 27-73814, 27-738141, 27-807218</p>	 <p>18-0954 JUNTA CODO ESCAPE Reemplaza: 27-92720</p>	<p>Pack de 2</p>  <p>18-2819-1 18-2819-9① JUNTA CODO ESCAPE Reemplaza: 27-39915</p>	<p>Pack de 2</p>  <p>18-2832-1 18-2832-1-9① JUNTA COLECTOR Reemplaza: 27-480431, 27-48043</p>
<p>Pack de 2</p>  <p>18-2833 18-2833-9① JUNTA CODO ESCAPE Reemplaza: 27-997772, 27-997771, 27-99777, 27-52076</p>	<p>Pack de 2</p>  <p>18-2849-1 18-2849-9-1① JUNTA CODO ESCAPE Reemplaza: 27-87105, 27-871051, 27-860232, 27-818832, 27-863726</p>	 <p>18-0158 JUNTA COLECTOR ADMISIÓN Reemplaza: 27-70905 Para: 3.7L</p>	 <p>18-0183-1 JUNTA COLECTOR ESCAPE Reemplaza: 27-73866, 27-54566</p>
 <p>18-0418 JUNTA COLECTOR ESCAPE Reemplaza: 27-46820</p>	 <p>18-2830-1 JUNTA COLECTOR ESCAPE En línea 6 cil. Reemplaza: 879036, 27-46401, 27-52584, 27-33121</p>	 <p>18-0680 JUNTA COLECTOR ESCAPE Reemplaza: 27-815528</p>	 <p>18-2896-1 JUNTA COLECTOR ESCAPE Reemplaza: 27-52546, 27-32816</p>





① Precio por pack





















 <p>18-2909 18-2909-9① JUNTA COLECTOR ESCAPE Reemplaza: 27-99757</p>	 <p>18-2949 JUNTA COLECTOR ESCAPE Reemplaza: 27-33395 GM 5.0L & 5.7L</p>	 <p>18-2912-1 JUNTA COLECTOR Reemplaza: 27-53354</p>	 <p>18-0956-1 JUNTA COLECTOR ESCAPE Reemplaza: 27-68715</p>	 <p>18-1204-1 18-1204-1-9① JUNTA COLECTOR ESCAPE Reemplaza: 27-96429</p>
--	--	--	--	--

 <p>18-61319 JUNTA TAPA VÁLVULA Reemplaza: 27-827154 Para: Mercruiser MCM 262 Mag & 4.3L/ LX/LH/LHX Gen+ con tapa válvula plástico(1996 & Sup); Todos GM V6 (1996 & sup)</p>	 <p>18-0664 JUNTA TAPA VÁLVULA Reemplaza: 27-17467, FI1101287 Para: GM 305/350, 5.0 & 5.7L</p>	 <p>18-2845 JUNTA TAPA VÁLVULA Reemplaza: 27-11999, 27-34043, 27-52202, FI1101236, FI5000161 V-8 GM 305/350 CID, 5.0 & 5.7L</p>	 <p>18-25001 JUNTA TAPA VÁLVULA Reemplaza: 27-14765, F3860315, FI1110294, FI1110958 Para: GM 454, 7.4L</p>
---	---	---	---

 <p>18-25002 JUNTA TAPA VÁLVULA Reemplaza: 27-811588 Para:GM 454, 502, (1992-SUP)</p>	 <p>18-0311 JUNTA TAPA VÁLVULA Reemplaza: 27-11988 Para: 4.3 Litros 262 CID</p>	 <p>18-0346 JUNTA TAPA VÁLVULA Reemplaza: 27-49936, 27-34042 Para: GM 250 CID (4.1L), 160/165/200 (6 cil.)</p>	 <p>18-0347 JUNTA TAPA VÁLVULA Reemplaza: 27-52145, 27-806452, 27-34041 Para: GM 153 & 181 CID (2.5L & 3.0L)</p>
--	---	---	--

 <p>18-0352 JUNTA TAPA VÁLVULA Reemplaza: 27-56173 Para: Ford 302/351 CID (5.0L & 5.8L)</p>	<p>Pack de 2</p>  <p>18-0464 18-0464-9① JUNTA TAPA VÁLVULA Reemplaza: 27-49121, 27-91831 Para: GM 454/502 CID (7.4L & 8.2L)</p> <table border="1"> <thead> <tr> <th>Modelo</th> <th>Año</th> <th>S/N</th> </tr> </thead> <tbody> <tr> <td>330</td> <td>1977-81</td> <td>4623115-6083144</td> </tr> <tr> <td>7.4 Bravo</td> <td>1988-91</td> <td>B771113-D603117</td> </tr> <tr> <td>454 Mag</td> <td>1986-92</td> <td>A631894-D805068</td> </tr> <tr> <td>370 TRS</td> <td>1978-87</td> <td>4179554-B714586</td> </tr> <tr> <td>400 TRS</td> <td>1980-86</td> <td>4179554-B457644</td> </tr> <tr> <td>400 TRS</td> <td>1983-86</td> <td>4179554-B485220</td> </tr> <tr> <td>460 TRS</td> <td>1983-86</td> <td>4179554-6181046</td> </tr> <tr> <td>502 Mag Bravo</td> <td>1990-92</td> <td>C878221-D824588</td> </tr> </tbody> </table>	Modelo	Año	S/N	330	1977-81	4623115-6083144	7.4 Bravo	1988-91	B771113-D603117	454 Mag	1986-92	A631894-D805068	370 TRS	1978-87	4179554-B714586	400 TRS	1980-86	4179554-B457644	400 TRS	1983-86	4179554-B485220	460 TRS	1983-86	4179554-6181046	502 Mag Bravo	1990-92	C878221-D824588	 <p>18-0468 JUNTA TAPA DISTRIBUCIÓN Reemplaza: 27-811572 GM 4.3L, 5.0L & 5.7L</p>
Modelo	Año	S/N																											
330	1977-81	4623115-6083144																											
7.4 Bravo	1988-91	B771113-D603117																											
454 Mag	1986-92	A631894-D805068																											
370 TRS	1978-87	4179554-B714586																											
400 TRS	1980-86	4179554-B457644																											
400 TRS	1983-86	4179554-B485220																											
460 TRS	1983-86	4179554-6181046																											
502 Mag Bravo	1990-92	C878221-D824588																											

 <p>18-0887 18-0887-9① JUNTA TAPA DISTRIBUCIÓN Reemplaza: 27-49953, 27-34216, FI5000201 4 & 6 Cil.</p>	 <p>18-0976 18-0976-9① JUNTA TAPA DISTRIBUCIÓN Reemplaza: 27-14250, 27-34895, FI1101297</p>	 <p>18-0980 JUNTA TAPA DISTRIBUCIÓN Reemplaza: 27-54529, 27-49109, 110990, 1100990 GM 7.4L</p>	 <p>18-0328 18-0328-9① JUNTA TAPA VARILLA EMPUJE Reemplaza: 27-34208 153 & 181 CID, 120/140 (4 Cil.)</p>
---	--	--	---

 <p>18-0329 JUNTA TAPA VARILLA DE EMPUJE Reemplaza: 27-34209 Para: 140/150/160/165 (6 cil.)</p>	 <p>18-2815 VARILLA DE EMPUJE Reemplaza: 27-814703, FI5000119, FI5000199 Para: 3.0L</p>	 <p>Pack de 2</p> <p>18-1210 18-1210-9① JUNTA TAPA LATERAL Reemplaza: 27-39923</p>	 <p>Pack de 2</p> <p>18-0185 18-0185-9① RETÉN ACEITE Reemplaza: 27-91892</p>
 <p>18-1240 JUNTA TAPA PARTE SUPERIOR Para Bravo Reemplaza: 12708</p>	 <p>Pack de 5</p> <p>18-2516 18-2516-9① JUNTA TRANSOM BRAVO Reemplaza: 16755, 16755A1, 16755Q1,</p>	 <p>Pack de 2</p> <p>18-2556 18-2556-9① JUNTA TRANSOM ALPHA ONE Reemplaza: 27-35996, A1</p>	 <p>18-2743 JUNTA TRANSOM ALPHA ONE Reemplaza: 27-94996, 27-949962, 27-94996A1, 27-94996A2, 27-94996Q2, 27-94996A3, 27-94996A20, 27-64818A2</p>
 <p>Pack de 5</p> <p>18-2820 18-2820-9① JUNTA TRANSOM ALPHA ONE Reemplaza: 27-64818, Q4, 27-64818A20, 27-64818A4, 27-64818A1, 27-45821</p>	 <p>Pack de 5</p> <p>18-2840 18-2840-9① JUNTA Reemplaza: 27-35982</p>	 <p>Pack de 2</p> <p>18-2847 18-2847-9① JUNTA TRANSOM Reemplaza: 27-54014, 27-54014A1, 27-54014Q1, 27-54014T1 Para: E, H, TR, TRS</p>	 <p>18-0386 JUNTA CUERPO BOMBA DE AGUA Reemplaza: 27-94914, 27-72780</p>
 <p>Pack de 2</p> <p>18-0894 18-0894-9① JUNTA TAPA AGUA Reemplaza: 27-55810, 27-55810 -1</p>	 <p>18-0916 JUNTA BOMBA AGUA Reemplaza: 27-8052151, 27-805215, 27-94915, 27-72779</p>	 <p>Pack de 2</p> <p>18-0903 JUNTA BOMBA AGUA Reemplaza: 27-49110, FI1101000 454 CID</p>	 <p>18-0147 JUNTA BOMBA AGUA Para Ford V-8 Reemplaza: 27-56880</p>
 <p>18-0327 JUNTA BOMBA AGUA Reemplaza: 27-33956, FI5000200, FI5000219 4 & 6 Cil.</p>	 <p>Pack de 2</p> <p>18-0891 18-0891-9① JUNTA MONTAJE BOMBA DE AGUA Reemplaza: 27-34897, 27-34896, FI5000077, FI5000078 Para: GM 4.3L, 5.0L & 5.8L</p>	 <p>Pack de 2</p> <p>18-0893 18-0893-9① JUNTA TRASERA BOMBA DE AGUA Reemplaza: 27-35380 GM 4.3L, 5.0L & 5.7L</p>	 <p>Pack de 2</p> <p>18-2564 18-2564-9① JUNTA IMPULSOR Alpha I - Generation 2 Reemplaza: 27-430331</p>

 <p>18-0950 JUNTA IMPULSOR ALOJAMIENTO Reemplaza: 27-88046 224 CID</p>	<p>Pack de 2</p>  <p>18-2565 18-2565-9① JUNTA IMPULSOR Alpha I - Generación 2 Reemplaza: 27-430472</p>	<p>Pack de 2</p>  <p>18-2566 18-2566-9① JUNTA IMPULSOR Alpha I - Generación 2 Reemplaza: 27-817277</p>	<p>Pack de 2</p>  <p>18-2823 18-2823-9① JUNTA BOMBA DE AGUA INFERIOR R: 27-32769, 27-19553</p>
<p>Pack de 2</p>  <p>18-2824 18-2824-9① JUNTA BOMBA DE AGUA SUPERIOR Reemplaza: 27-32770, 27-19551</p>	<p>Pack de 2</p>  <p>18-2825 18-2825-9① JUNTA BASE BOMBA AGUA Reemplaza: 27-32771</p>	<p>Pack de 2</p>  <p>18-2826 18-2826-9① JUNTA BASE BOMBA DE AGUA Reemplaza: 27-856101, 27-856704, 27-85610</p>	<p>Pack de 2</p>  <p>18-2914 18-2914-9① JUNTA BOMBA AGUA Reemplaza: 27-856081, 27-85608, 27-32433, 27-30603, 27-8M0090319</p>
<p>Pack de 2</p>  <p>18-2915 18-2915-9① JUNTA BOMBA AGUA Reemplaza: 27-856091, 27-858524, 27-85609, 27-32434, 27-30604</p>	<p>Pack de 2</p>  <p>18-2919 18-2919-9① JUNTA BOMBA AGUA Reemplaza: 27-426311, 27-42631</p>	 <p>18-0342 JUNTA BASE POWER TRIM Reemplaza: 27-476441, 27-47644</p>	 <p>18-0388 JUNTA TUBO POWER TRIM Reemplaza: 27-988231, 27-98823</p>
<p>Pack de 2</p>  <p>18-0322 18-0322-9① JUNTA PORTA RETÉN Reemplaza: 27-14241, 27-881715, F11101656 GM 5.0L & 5.7L</p>	 <p>18-3289 RETÉN DOBLE CAMBIO Reemplaza: 26-864319 Para: Gen II alojamiento superior</p>	 <p>18-2094 RETÉN ACEITE Reemplaza: 26-36143, 26-88416 Para: 120/140(1978-82), 165 (1978-81), 260 (1978-82), 470 (1978-82), 485 (1980-82), 898/228 (1978-82), Alpha I/Gen II (1991 & sup), Blackhawk (1994-95), Bravo I/II/III (1988-98), R/MR/colas Alpha One y Transom (1983-90)</p>	 <p>18-2944 18-2944-9① JUNTA TÓRICA (Quad Ring) Reemplaza: 26-45577, 26-455771</p>
<p>Pack de 2</p>  <p>18-2945 18-2945-9① 18-29451-9① (Pack de 50) JUNTA TORNILLO DRENAJE Reemplaza: 12-20260, 12-19183, 12-191832, 12-191833, F50556, F8077, F8186 Usado en la mayoría de partes inferiores y bombas de agua salada</p>	<p>Pack de 5</p>  <p>18-2948 18-2948-9① ARANDELA DE GOMA Reemplaza: 12-492211, 12-49221, 12-23245</p>	 <p>18-2349 MANGUITO EJE CAMBIO Reemplaza: 23-67370 Para: Ratios 1.47, 1.62, 1.81 & 1.94. Para: Gen II (1998 & sup), (0L100040 & sup) 1/4"</p>	<p>Pack de 2</p>  <p>18-0905 18-0905-9① JUNTA TAPÓN DRENAJE ACEITE Reemplaza: 27-49955, 27-34502, 27-60721, 27-8M0077608</p>

<p>Pack de 2</p>  <p>18-4267 18-4267-9① ARANDELA Reemplaza: 12-29395, 12-8M0042641</p>	<p>Pack de 3</p>  <p>18-0681 18-0681-9① ARANDELA Reemplaza: 12-32834, 12-8M2001219, 12-93416, 12-934161</p>	<p>Pack de 5</p>  <p>18-0203 18-0203-9① ARANDELA ALOJA- MIENTO TRANSOM Reemplaza: 12-35935 Todos Mercruiser Stern drives 1963-1998</p>	<p>Pack de 5</p>  <p>18-2316 18-2316-9① ARANDELA VARILLA CAMBIO Reemplaza: 12-77674, 12- 25410 Usa manguito 18-2349 Para: Ratios 1.47, 1.62, 1.81 & 1.94.For: Gen II (1998 & sup), (0L100040 & sup) 1/8" Thick</p>																		
 <p>18-0318 ARANDELA Reemplaza: 12-815472</p>	<p>Pack de 2</p>  <p>18-4270 18-4270-9① ARANDELA Reemplaza: 12-36001</p>	<p>Pack de 5</p>  <p>18-2340 18-2340-9① ARANDELA VARILLA CAMBIO Reemplaza: 12-31266 Para: #1R/MR (1/16" grosor)</p>	<p>Pack de 2</p>  <p>18-2343 18-2343-9① ARANDELA TUERCA PIÑON Reemplaza: 12-92721 Para: MR/Alpha/Gen II</p>																		
 <p style="text-align: center;">TORNILLOS</p> <table border="1"> <thead> <tr> <th>Ref #</th> <th>Descripción</th> <th>O.E. #</th> </tr> </thead> <tbody> <tr> <td>18-2361</td> <td>(Pack. de 2)</td> <td>10-805763, 10-853163</td> </tr> <tr> <td>18-2361-9①</td> <td>Tornillo montaje parte inf</td> <td>10-30206</td> </tr> <tr> <td>18-3197</td> <td>Tornillo</td> <td>10-76156, 10-67373</td> </tr> <tr> <td>18-3230</td> <td>Tornillo</td> <td>10-816601</td> </tr> <tr> <td>18-3231</td> <td>Tornillo</td> <td>10-98794</td> </tr> </tbody> </table>			Ref #	Descripción	O.E. #	18-2361	(Pack. de 2)	10-805763, 10-853163	18-2361-9①	Tornillo montaje parte inf	10-30206	18-3197	Tornillo	10-76156, 10-67373	18-3230	Tornillo	10-816601	18-3231	Tornillo	10-98794	<p>Pack de 5</p>  <p>18-3721 18-3721-9① TUERCA AUTOBLOCANTE Reemplaza: 11-13439-1, 11-859116 Para: MR/Alpha</p>
Ref #	Descripción	O.E. #																			
18-2361	(Pack. de 2)	10-805763, 10-853163																			
18-2361-9①	Tornillo montaje parte inf	10-30206																			
18-3197	Tornillo	10-76156, 10-67373																			
18-3230	Tornillo	10-816601																			
18-3231	Tornillo	10-98794																			
 <p>18-3236 CASQUILLO ALINEAMIENTO ALOJAMIENTO Reemplaza: 23-32632 Para: #1R/MR/Alpha</p>	 <p>18-4272 TAPA D.E. 0.870" Reemplaza: 19-32652</p>	 <p>18-4273 TAPA D.E. 1.250" Reemplaza: 19-42682</p>	 <p>18-2140 KIT TORNILLO SOPORTE DE MOTOR Para: Mercruiser I</p>																		
 <p>18-2141 KIT TORNILLOS SO- PORTE DE MOTOR Reemplaza: 10-97934A1 Para: R/MR/Alpha I/ Gen II/Bravo</p>	 <p>18-3728 TUERCA AUTOBLOCANTE Reemplaza: 11-99298, 11-863332</p>	 <p>18-3729 TORNILLO 1/2" - 20 x 5 3/8" Reemplaza: 10-97934, 10-36289</p>	 <p>18-2193 SILENT-BLOCK TRASERO Reemplaza: 33149, 99297A1, 99297A2 Para 120/140 HP S/N 6229717 & SUP; TODOS 224 CID Blocks; todos 898, 200, 228, 230, 260, 300 & 320 HP; Todos 350- 454 Magnums</p>																		

① Precio por pack

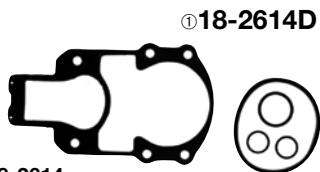

18-2614
KIT JUNTAS ALPHA ONE
1967-1982
 Reemplaza: 27-64818A1, 27-64818T4,
 27-64818Q4, 27-64818A20, 27-64818A4,
 27-64818, 27-45821

— CONTIENE —

Ref #	Descripción	O.E. #	Cant.
18-2820	Junta	27-64818	1
18-2840	Junta	27-35982	1
18-7153	Aro	25-25439	2
18-7170	Aro	25-33504	1

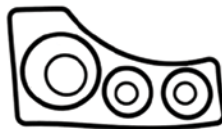

18-2615
KITS JUNTAS BRAVO
(Unidad Bravo)
 Reemplaza: 16755, 16755A1, 16755Q1,
 16755T1
 Para: Todos Bravo

— CONTIENE —

Ref #	Descripción	O.E. #	Cant.
18-2516	Retén	16755	1
18-7198	Aro	25-45710	1
18-7153	Aro	25-25439	2
18-7168	Aro	25-48171	2
18-7105	Aro	25-62705	1
18-7117	Aro	25-35027	1



18-2617
KIT JUNTAS
Modelo antiguo
 Reemplaza: 27-35996, 27-35996A1
 Para: IA/IB/IC y EZ Shift (1964-1966)

— CONTIENE —

Ref #	Descripción	O.E. #
18-2556	Junta	27-35996
18-2840	Junta	27-35982
18-7153	Aro	25-25439
18-7170	Aro	25-33504



18-2619-1
KITS JUNTAS ALPHA ONE
 Reemplaza: 27-64818A3, 27-94996Q2, 27-94996T2, 27-94996,
 27-94996A1, 27-94996A2, 27-94996A20, 27-64818A2, 27-64818A3
 Para: R, MR, Alpha I, Alpha Gen II (1983-Nuevos)

— CONTIENE —

Ref #	Descripción	O.E. #
18-2743	Juntas	27-94996-2
18-2840	Junta	27-35982
18-7153	Aros	25-25439
18-7170	Aros	25-33504
18-7117	Aros	25-35027



18-2620
KIT JUNTAS COLA
 Reemplaza: 27-54014A1, 27-54014Q1, 27-54014T1, 27-54014
 Para: E, H, TR, TRS

— CONTIENE —

Ref #	Descripción	O.E. No.
18-7175	Aro	25-62817
18-2847	Junta	27-54014

① Referencias acabadas en "D" envasadas - Referencias normal no envasada

transmisión Modelo	Desde Nº serie.	Hasta Nº serie.	Juntas transom	Aro Tórico transom	Junta caucho	Aro tórica (2 se necesitan)	Juego Juntas
I	1534570	1684187	—	18-7170	—	18-7153	—
IA	1684188	2062140	18-2556	18-7170	18-2840	18-7153	18-2617
IB	1684633	2062140	18-2556	18-7170	18-2840	18-7153	18-2617
IC	1685240	2065189	18-2556	18-7170	18-2840	18-7153	18-2617
II TR	3377316	4794899	18-2847	18-7175	—	—	18-2620
120	2062141	6225576	18-2820	18-7170	18-2840	18-7153	18-2614
120	6225577	SUP	18-2743	18-7170	18-2840	18-7153	18-2619-1
120	6225577	SUP	18-2743 ③	18-7170	18-2840	18-7153	18-2619-1
140	2062141	6225576	18-2820	18-7170	18-2840	18-7153	18-2614
140	6225577	SUP	18-2743	18-7170	18-2840	18-7153	18-2619-1
140	6225577	SUP	18-2743 ③	18-7170	18-2840	18-7153	18-2619-1
160	2065190	2763441	18-2820	18-7170	18-2840	18-7153	18-2614
165	2763442	SUP	18-2820	18-7170	18-2840	18-7153	18-2614
170	6225577	SUP	18-2743	18-7170	18-2840	18-7153	18-2619-1
170	6225577	SUP	18-2743 ③	18-7170	18-2840	18-7153	18-2619-1
185	6225577	SUP	18-2743	18-7170	18-2840	18-7153	18-2619-1
185	6225577	SUP	18-2743 ③	18-7170	18-2840	18-7153	18-2619-1
190	6225577	SUP	18-2743	18-7170	18-2840	18-7153	18-2619-1
190	6225577	SUP	18-2743 ③	18-7170	18-2840	18-7153	18-2619-1
200	6225577	SUP	18-2743	18-7170	18-2840	18-7153	18-2619-1
200	6225577	SUP	18-2743 ③	18-7170	18-2840	18-7153	18-2619-1
215 E/H	2782203	2915034	18-2847	18-7175	—	18-7153 ①	18-2620
225	3856268	4200499	18-2820	18-7170	18-2840	18-7153	18-2614
228	4782330	6225576	18-2820	18-7170	18-2840	18-7153	18-2614
228	6225577	SUP	18-2743	18-7170	18-2840	18-7153	18-2619-1
228	6225577	SUP	18-2743 ③	18-7170	18-2840	18-7153	18-2619-1
230	6225577	SUP	18-2743	18-7170	18-2840	18-7153	18-2619-1
230	6225577	SUP	18-2743 ③	18-7170	18-2840	18-7153	18-2619-1
233	4200500	SUP	18-2820	18-7170	18-2840	18-7153	18-2614
250	4791300	4898729	18-2820	18-7170	18-2840	18-7153	18-2614
255 TRS	3377316	4203749	18-2847	18-7175	—	—	18-2620
260	4898730	6225576	18-2820	18-7170	18-2840	18-7153	18-2614
260	6225577	SUP	18-2743	18-7170	18-2840	18-7153	18-2619-1
260	6225577	SUP	18-2743 ③	18-7170	18-2840	18-7153	18-2619-1
280 TRS	4203750	4895399	18-2847	18-7175	—	—	18-2620
470	4208730	6225576	18-2820	18-7170	18-2840	18-7153	18-2614
470	6225577	SUP	18-2743	18-7170	18-2840	18-7153	18-2619-1
470	6225577	SUP	18-2743 ③	18-7170	18-2840	18-7153	18-2619-1
485	4893835	SUP	18-2820	18-7170	18-2840	18-7153	18-2614
488	6225577	SUP	18-2743	18-7170	18-2840	18-7153	18-2619-1
488	6225577	SUP	18-2743 ③	18-7170	18-2840	18-7153	18-2619-1
888	3106717	SUP	18-2820	18-7170	18-2840	18-7153	18-2614
898	4782330	6225576	18-2820	18-7170	18-2840	18-7153	18-2614
898	6225577	SUP	18-2743	18-7170	18-2840	18-7153	18-2619-1
898	6225577	SUP	18-2743 ③	18-7170	18-2840	18-7153	18-2619-1
R/MR/Alpha One	6225577	SUP	18-2743	18-7170	18-2840	18-7153	18-2619-1
R/MR/Alpha One	6225577	Sup	18-2743 ③	18-7170	18-2840	18-7153	18-2619-1
Bravo (I/II)	B664190	SUP	18-2516	—	—	18-7153	18-2615
TR-TRS	4794900	SUP	18-2847	18-7175	18-2847	18-7153 ②	18-2620

① Sólo cambio hidráulico

② Sólo transmisiones Borg Warner

③ Para alojamientos con válvula antirretorno en el depósito aceite

THE WIDEST VARIETY OF MARINE OILS, LUBES & FILTERS IN THE MARINE INDUSTRY.

OILS & LUBRICANTS

- All blends meet or exceed engine manufacturers' specifications. All Sierra Oils & Lubes "WILL NOT VOID" engine manufacturers' warranties.
- **FC-W** available in:
 - Premium 10W30, 25W40
 - Semi Synthetic 10W40, 25W40, 25W50
 - Full Synthetic 10W30
- **Other 4-Cycle Oils** available in:
 - Premium Diesel 15W40
 - Full Synthetic Gas/Diesel SAE30
- **Gear Lubes** available in:
 - Premium Blend
 - Hi-Performance Synthetic Blend
 - Synthetic
- **Premium Marine Bearing Grease**
Available in 15oz tubes

*Also available 16 & 55 gallon drums



FILTRATION

- **FUEL FILTERS/FUEL WATER SEPARATORS**
Sierra is an industry leader in 10-micron filter technology and offers an extensive line of 21-micron filters.
- **OIL FILTERS**
Sierra oil filter designs represent the very best of what we have learned after decades of research and development. No matter what type of boat you drive.



www.sierramarine.com

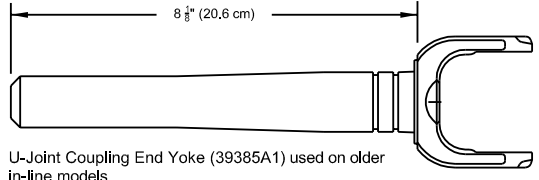
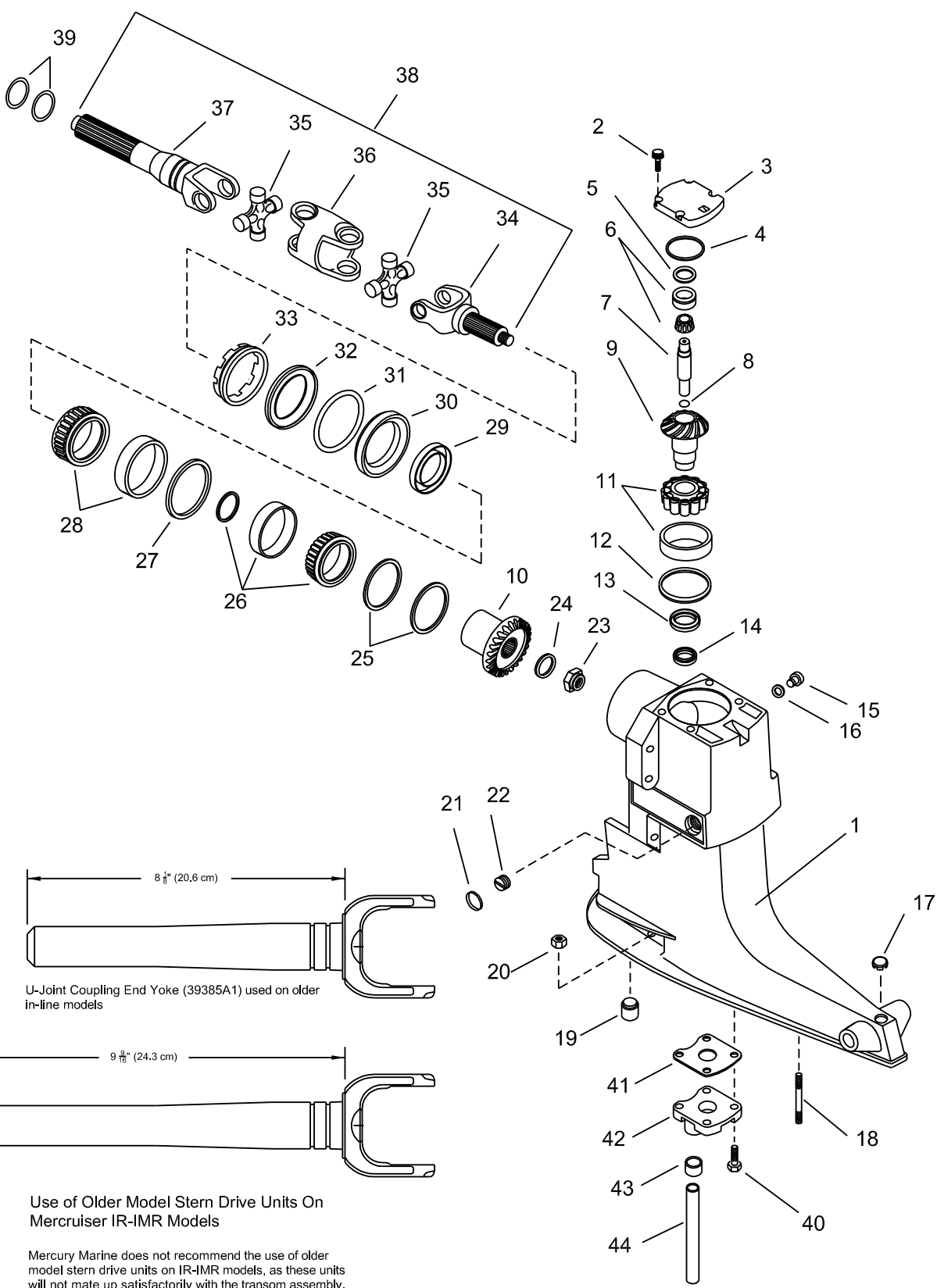

U-Joint Coupling End Yoke (39385A1) used on older in-line models

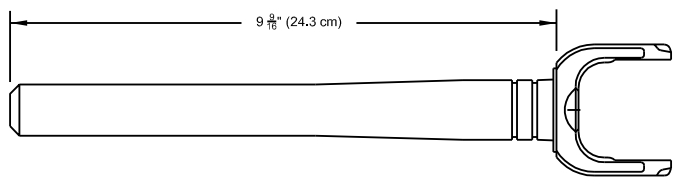

Use of Older Model Stern Drive Units On Mercuruiser IR-IMR Models

Mercury Marine does not recommend the use of older model stern drive units on IR-IMR models, as these units will not mate up satisfactorily with the transom assembly. In addition, the older model in-line stern drive units are equipped with U-Joint coupling end yoke (39385A1). This yoke is shorter than yoke (59830A1) used on the IR-IMR stern drive units, and therefore, will not fully engage the engine coupler splines. **Use of an older In-Line model stern drive unit on a IR-IMR model will result in a spline failure to coupling and/or yoke.**

Fig #	Descripción	Ref #	O.E.M. #	Cant.
1	Carcasa parte superior	N/D	1547-9412A18	1
2	Tomillo tapa superior	18-3231	10-98794	4
3	Tapa superior	18-2381	94998A2	1
4	Aro tórico superior	18-7161	25-32546	1
5	Grueso para eje	18-2283	15-45691A1	1
6	Rodamiento tapa	18-1165	31-61100A1	1
7	Eje vertical	18-2179	45-55796	1
8	Aro tórico eje vertical	18-7445	25-55801	1
9./10.	Juego de piñones			
	1.5:1	18-2201	43-18410A2, 46-18411A2	1
	Kit de reparación	18-2256	43-803116T1	1
	1.65:1	18-2203	43-45814A5	1
	Kit de reparación	18-2257	43-803112T1	1
	1.84:1	18-2204	43-75325A3	1
	Kit de reparación	18-2258	43-803114T1	1
	1.98:1	18-2205	43-55778A3	1
	Kit de reparación	18-2259	43-803101T1	1
11	Rodamiento cónico	18-1161	31-35990A1	1
12	Kit de grueso eje vertical	18-2293	15-36178A1	1
13	Retén aceite del alojamiento vertical	18-2049	26-32511	1
14	Retén del alojamiento del eje inferior	18-2056	26-96503	1
15	Tapón de ventilación	18-2244	10-79953A2	1
16	Junta tapón de ventilación	18-2945	12-19183, 12-20260	1
17	Tapón tornillo ánodo de timón	18-3232	19-47579	1
18	Espárrago unión carcasa	N/D	16-56295	2
19	Casquillo carcasa	18-3236	23-32632	1
20	Tuerca espárrago carcasa	18-2362	11-13439-1	3
21	Tapón			
	(7/8" OD)	18-4272	19-32652	1
	(1 1/4" OD)	18-4273	19-42682	1
22	Tapón	18-4265	22-428611	1
23	Tuerca de piñón	18-3713	11-22339	1
24	Arandela de tuerca de piñón	18-3712	12-45810	1
25	Kit de gruesos eje	18-2292	15-35980A1	1
26	Kit de rodamiento	18-1160	31-35988A2, A12	1
27	Espaciador (Incluido en el kit)	18-1160	31-35988A2, A13	1
28	Kit de rodamiento (Incluido en el kit)	18-1160	31-35988A2, A13	1
29	Retén aceite	18-2003	26-64893	1
30	Porta retén	18-0577	66081A2	1
31	Aro tórico	18-7169	25-70937	1
32	Arandela tuerca eje	18-4296	35983	1
33	Tuerca eje cardan	18-3752	816811-1	1
34	Eje trasero cardan	18-2125	46020T	1
35	Cruceta cardan	18-2104	75832A2	1
36	Núcleo carda	18-2128	39383T	1
37	Eje cardan delantero	18-2146	59830A1	1
38	Cardan completo	18-9218	59830A5	1
39	Aro tórico	18-7153	25-25439	2
40	Tornillo	18-3229	10-28668	4
41	Junta	18-0894	27-55810	1
42	Tapa (se vende como conjunto incluye 40-44)	18-3219	42724A3	1
43	Junta bomba agua	18-3110	26-38970	1
44	Tubo de agua	18-3220	32-54236	1

AR Se requiere

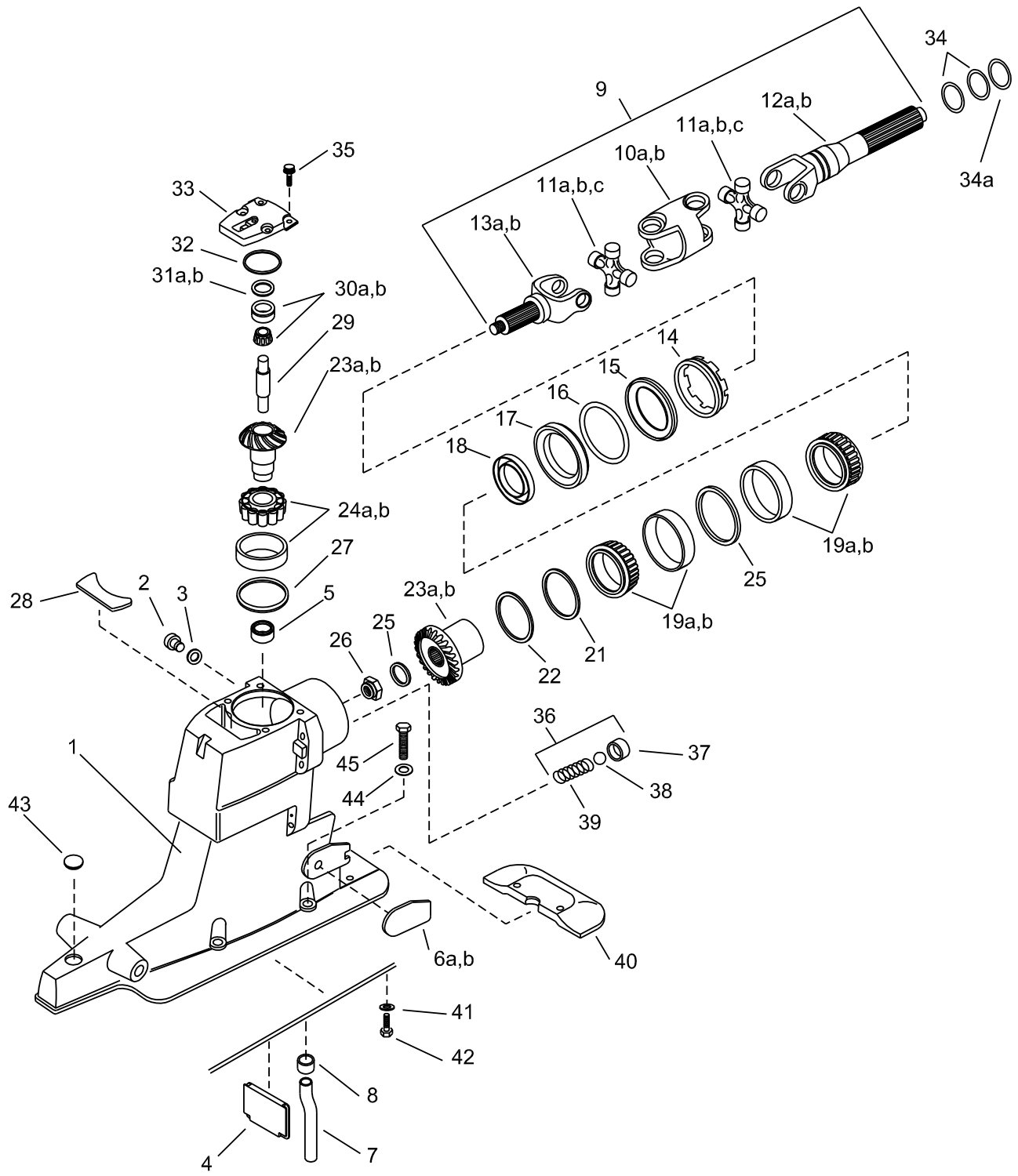

Fig #	Descripción	Ref #	O.E.M. #	Cant.	Fig #	Descripción	Ref #	O.E.M. #	Cant.
1	Carcasa superior (OL100009 & SUP)	18-2411	1547-861063A 4	1		Kit reparación	18-2364	43-803119T 1	1
2	Tornillos	18-2244	10-79953A2	1		1.84:1/ 1.81:1 Juego engrajes sup (Dientes... 17/19)	18-2204	43-75325A3	1
3	Arandela	18-2945	12-19183, 12-20260	1		Kit reacondicionamiento	18-2258	43-803114T 1	1
4	Separador escape	N/D	815932	1		Kit reparación	18-2365	43-803120 T 1	1
5	Retén aceite	18-2056	26-66302	AR		1.98:1/ 1.94:1 Juego engranajes sup (dientes... 20/24)	18-2205	43-55778A3	1
6a	Tapa babor	NSS	814386	1		Kit de reacondicionamiento	18-2259	43-803101T 1	1
6b	Tapa estribor	NSS	814387	1		Kit reparación	18-2363	43-803118T 1	1
7	Tubo agua	18-3221	32-860220	1	23a	Kit unidad superior (OL100009 & SUP)			
8	Retén	NSS	26-88397	1		1.47:1 Juego engranajes sup (dientes... 20/22)	18-6351	43-853641A2	1
9	Eje transmisión (OK999999 & post)	18-9218	814819A2	1		Kit reparación	18-6351K	43-803103T 1	1
	Eje transmisión (OL100009 & SUP)	18-6402	864281A2	1		1.62:1 & 2.0:1 Juego engranajes sup (Dientes... 24/24)	18-6350	43-853640A2	1
10a	Rótula cardan (diseño antiguo)	18-2128	343831, 39383T	1		Kit reparación	18-6350K	43-803104T 1	1
10b	Rótula cardan	NSS	865503T	1		1.81:1 Juego engranajes sup (Dientes... 17/19)	18-6353	43-853643A2	1
11	Cruceta cardan					Kit reparación	18-6352K	43-803106T 1	1
11a	D469859 - F679999 (diseño antiguo)	18-2174	75832A2	2		1.94 & 2.4:1 Juego engranajes (dientes... 20/24)	18-6352	43-853642A2	1
11b	F680000- OK999999 (Diseño antiguo- peralube)	18-2097	8055361, 805536A1 805536A2	2		Kit reparación	18-6353K	43-803105T 1	1
11c	OL100009 & SUP (GKN Serie)	18-6406	865493A01	2		24 Cojinetes (All but 1.47:1 ratio)	18-1161	43-803106T 1	1
12a	Eje largo cardan (OK999999 & post)	18-2146	59830A1	1		24a Cojinetes (1.47:1 Ratio only)	18-1142	31-32573A 1	1
12b	Eje delantero cardan (OL100009 & SUP)	18-6405	865491A01	1		25 Arandela	18-3712	12-45810	1
13a	Eje corto cardan (OK999999 & post)	18-2125	46020T	1		26 Tuerca	18-3713	11-22339	1
13b	Eje trasero cordan (OL100009 & SUP)	18-6403	865492T	1	27	Kit Gruesos	18-2293	15-36178A1	1
14	Tuerca eje cordan	18-3752	816811-1	1	28	Tapón	NSS	861738	1
15	Aro	18-4296	35983	1	29	Eje sup (F680000 & Sup)	18-2324	45-55796-1	1
16	Aro tórico	18-7169	25-70937	1	30	Rodamiento			
17	Porta retén (Set)	18-0577	66081A2	1	30a	F680000 & SUP (rodamiento peq)	18-1179	31-32575A1	1
18	Retén aceite	18-2003	26-68493	1	30b	D494569 - F679999 (rod.grande)	18-1165	31-61100A1	1
19	Kit de rodamiento (D469859 - K999999)	18-1160	31-35988A2, A12	1	31	Kit Gruesos			
19a	Kit de rodamiento (OL100009 & SUP)	18-1182	31-30894A 15	1	31a	D494569 -F679999	18-2283	15-45691A1	1
20	Espaciador (Incluye con 18-1160)	18-1160	31-35988A2, A12	AR	31b	F680000 & SUP	18-2282	15-32563A1	1
20a	Espaciador (Incluye con 18-1182)	NSS	23-853649A 1	AR	32	Aro	18-7161	25-32546	1
21	Aro Kit	18-2292	15-35980A1	1	33	Tapa superior (F680000 & Sup)	18-2382	828692A1	1
22	Espaciador Spacer	18-2296	15-71013	1	34	Aro	18-7153	25-25439	2
23	Kit unidad superior (OD469859-OK999999)				34a	Aro	18-7117	25-35027	1
	1.5:1/ 1.47:1 Juego engranajes sup (dientes... 20/22)	18-2201	43-18410A2, 43-18411A2	1	35	Tornillos	18-3231	10-98794	4
	Kit reacondicionamiento	18-2256	43-803116T 1	1	36	Kit válvula	18-2715 KIT	24-17997A1	1
	Kit reparación	18-2358	43-803102T 1	1	37	Retén aceite (Incluido en Kit)	NSS	—	1
	1.65:1/ 1.62:1 Juego engranajes sup (Dientes... 24/24)	18-2203	43-45814A5	1	38	Bola (Incluido en Kit)	NSS	—	1
	Kit reacondicionamiento	18-2257	43-803112T 1	1	39	Muelle	NSS	—	1
					40	Anodo	18-6080	821629A1	1
					41	Arandela de cierre	N/D	13-78968	2
					42	Tornillos	18-3229	10-28668	2
					43	Tapón	N/D	19-824928	1
					44	Arandela	18-4858-9	12-45176	4
					45	Tornillo	18-3230	10-816601	4

AR Se requiere

NSS No se vende por separado

N/D No disponible

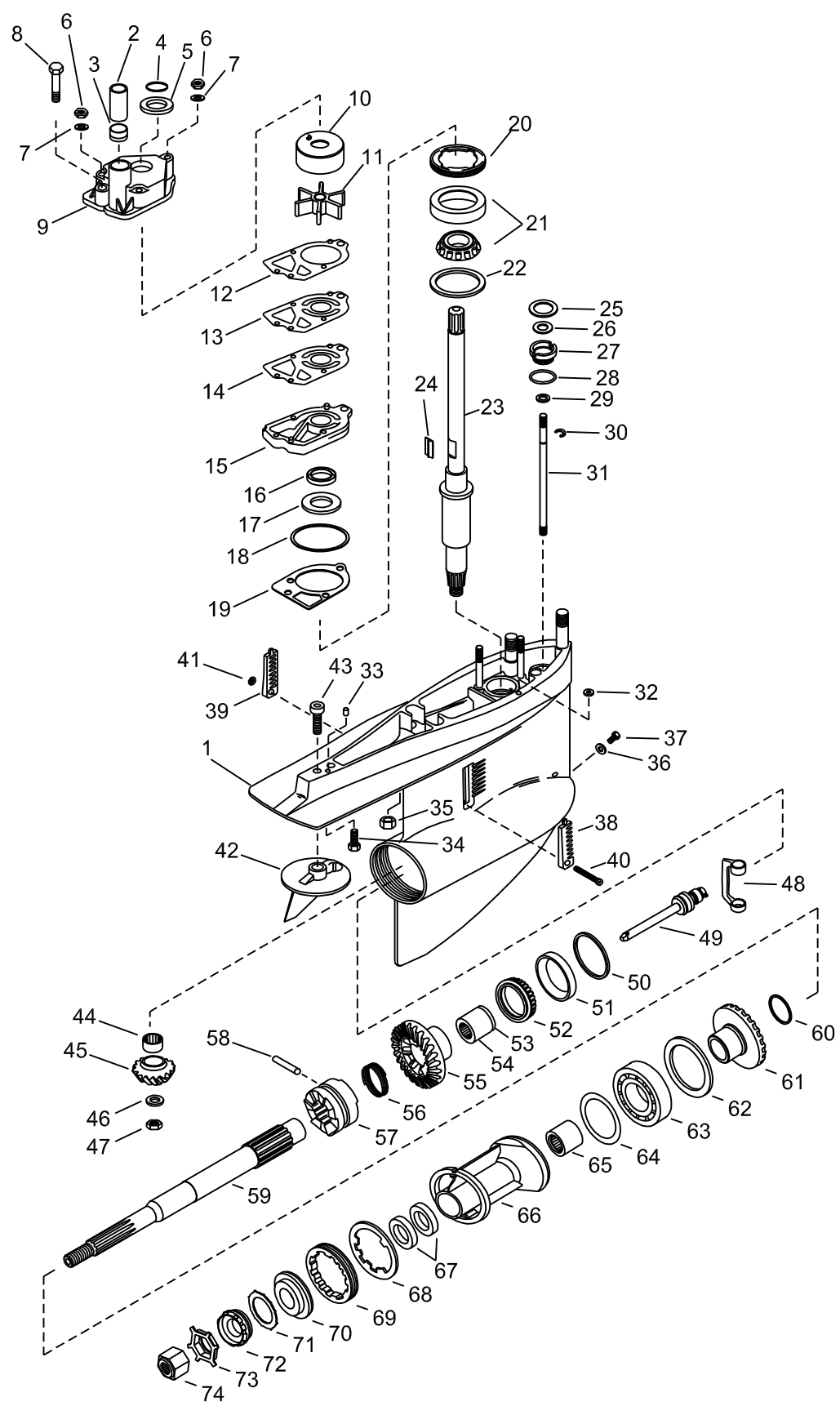

Fig #	Descripción	Ref #	O.E.M. #	cant.	Fig #	Descripción	Ref #	O.E.M. #	Cant.
1	Caja engranajes	18-2401	1623-8951A37	1	44	Cojinete agujas	18-1117	31-42647A1	1
2	Tubo guía agua	18-3109	23-29804	1	45	Kit pñones parte inferior Alpha	18-2206	43-17064A2, 43-17064A3, 43-42934	1
3	Casquillo bomba agua	18-3110	26-38970	1					
4	Aro tórico eje superior	18-7158	25-30613	1					
5	Goma	18-7426	25-30271	1	46	Arandela	18-2343	22-92721	1
6	Tuercas apriete (5/16-24)	N/D	11-13436	1	47	Tuerca piñon	18-3719	11-35921	1
	Acero inoxidable (1/4-28)	N/D	11-13438	2	48	Leva	18-2130	76865	1
7	Arandela	18-4270	12-36001	3	49	Pasador	18-2286	818349A1	1
8	Tornillo	N/D	10-96411	1	50	Grueso	18-2285	15-47397A1	1
					51	Rodamiento cónico	18-1159	31-35928A1	1
9	Alojamiento bomba superior	18-3116	46-96148A1	1	52	Rodamiento agujas	18-1157	31-30895	1
10	Acoplamiento	18-3114	48752	1	53	Circlip rodamiento	N/D	—	1
11	Impulsor	18-3017	47-89984	1	54		18-1157	31-30895	1
12	Junta	18-2915	27-85609-1	1	55	Kit piñones parte inferior alpha	18-2206	43-17064A2, 43-17064A3, 43-42934	1
14	Junta	18-2914	27-85608-1	1	56	Pasador trinquete	18-2348	24-30893	1
					57	Trinquete embrague	18-2202	52-66063	1
15	Base bomba agua	18-3420	46-44292A3	1	58	Pasador	18-2357	24-30893	1
16	Retén aceite (sup)	18-2013	26-16977	1	59	Eje hélice	18-2166	44-66060, 44-6606-3	1
17	Retén aceite (inf)	18-2014	26-89238	1					
18	Aro tórico, bomba agua	18-7176	25-90011	1	60	Espaciador piñon marcha reverso	N/D	23-824108	1
19	Junta	18-2919	27-42631-1	1	61	Kit piñones parte inferior alpha (Engr. reverso-NSS)	18-2206	43-17064A2, 43-17064A3, 43-42934	1
21	Rod. rodillos cónicos eje accion.	18-1143	31-36387A1	1	62	Arandela seguro	18-2342	68100-1	1
22	Kit Gruesos	18-2294	15-42637A1	1	63	Rodamiento a bolas	18-1155	30-88957A1	1
23	Eje	18-2180	45-42634	1	64	Aro tórico	18-7159	25-31534	1
24	Chaveta impulsor bomba de agua	N/D	28-56654	1	65	Cojinete aguja	18-1158	31-30956	1
25	Arandela	18-4267	12-29395	1	66	Cojinete Diabolo	18-2191	73020A-14	1
26	Arandela	18-2340	12-31266	1	67	Retén aceite	18-2002	26-76868	2
27	Casquillo	18-2154	23-30617A2	1	68	Arandela	18-2298	14-18323	1
28	Aro tórico	18-7153	25-25439	1	69	Tuerca	18-3751	79448	1
29	Arandela	NSS	12-27880	1	70	Arandela	18-4220	13171, 77987	1
30	Clip retención eje cambio	NSS	53-29641	1	71	Arandela de continuidad	N/D	13-423511	1
31	Eje cambio acero inox	18-2150	77481-1	1	72	Arandela de cierre	18-3714	12-31211A2	1
32	Retén aceite	18-2944	26-45577	1	73	Arandela	18-3200	14-31210, 14-816629	1
33	Pin centrador	18-3226	10-30720	2					
34	Tornillo	18-2361	10-30206	1	74	Tuerca	18-3700	11-52707	1
36	Junta	18-2945	12-19183, 12-20260	1					
37	Conector	18-2244	10-79953A2	1					
38	Rejilla (estribor)	18-3199	93423-1	1					
39	Rejilla babor	118-3198	93424-1	1					
40	Tornillo	18-3197	10-76156	1					
41	Tuerca	18-2344	11-45812	1					
42	Ánodo timón	18-6011	31640A1	1					
43	Tornillo	18-6245	10-32470	1					

N/D No disponible

NSS No se vende por separado

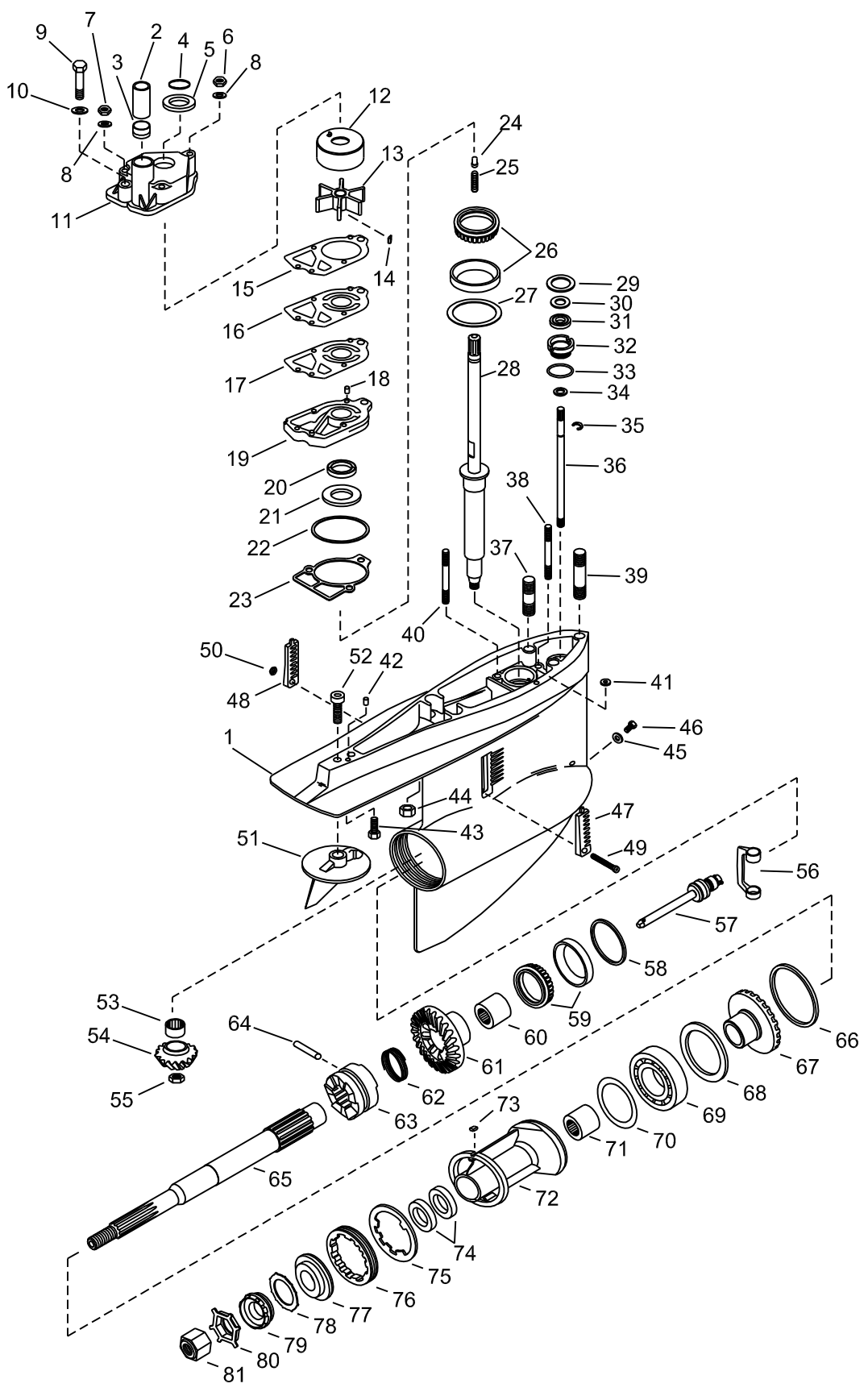

Fig #	Descripción	Ref #	O.E.M. #	Cant.	Fig #	Descripción	Ref #	O.E.M. #	Cant.
1	Caja engranajes inferior	N/D	1623-5356A4	1	42	Pasador	N/D	17-35973	2
2	Tubo guía agua	18-3109	23-29804	1	43	Tornillo	18-2361	10-30206	1
3	Casquillo	18-3110	26-38970	1	44	Tuerca	N/D	11-82671015	2
4	Aro tórico	18-7158	25-30613	1	45	Junta	18-2945	12-19183,	
5	Goma	18-7426	25-30271	1				12-20260	1
6	Tuerca apriete acero inox (5/16-24)	18-3723	11-45592	1	46	Tapón aceite	18-2244	10-79953A2	1
7	Tuerca apriete acer inox (1/4-28)	18-3722	11-20361,	2	47	Rejilla Estribor	N/D	66885	1
			11-35888		48	Rejilla Babor	N/D	66884	1
8	Arandela	18-4275	12-29245	3	49	Tornillo	18-3197	10-76156	1
9	Tornillo	18-3226	10-30720	1	50	Tuerca	18-2344	11-45812	1
10	Arandela	18-4270	12-36001	1	51	Ánodo timón	18-6011	31640A1	1
11	Alojamiento bomba superior	18-3116	46-96148A1	1	52	Tornillo	18-6245	10-32470	1
12	Acoplamiento	18-3114	48752	1	53	Cojinete agujas	18-1150	31-92366A1	1
13	Impulsor	18-3017	47-89984	1	54	Piñón reverso	18-2200	23-96084A4	1
14	Chaveta	N/D	28-56654	1	55	Tuerca piñón	18-3719	11-35921	1
15	Junta	18-2915	27-85609-1	1	56	Grapa eje	18-2130	76865	1
16	Platina impulsor	18-3117	32435	1	57	Conjunto Carrete inversor	19755A2	18-2286	1
17	Junta	18-2914	27-85608-1	1	58	Grueso	18-2285	15-47397A1	1
18	Alojamiento	18-3227	17-35973	2	59	Cojinete cónico	18-1159	31-35928A1	1
19	Base bomba agua	18-3417	46-57234A1	1	60	Cijinete agua	18-1157	31-30895	1
20	Retén (sup)	18-2026	26-16977	1	61	Kit unidad inferior	18-2200	23-96084A4	1
21	Retén (inf)	18-2014	26-89238	1	62	Pasador trinquete embrague	18-2348	24-30893	1
22	Aro (2.175 ID) & (2.1091 ID)	18-7176,	25-90011	1	63	Trinquete embrague	18-2202	52-66063	1
		18-7196			64	Pasador trinquete embrague	18-2348	17-30632	1
23	Junta	18-2826	27-85610-1	1	65	Eje de hélice	18-2166	44-66060,	
24	Pasador	N/D	17-30545	1			44-66060-3	1	
25	Muelle	N/D	24-34576	1	66	Grueso	18-2284	15-31535A1	1
26	Cojinete cónico	18-1164	31-53079A1	1	67	Piñón reverso	18-2200	43-96084A4	1
27	Grueso	18-2295	15-57007A	1	68	Aro	18-3759	35915	1
28	Drive Shaft	N/D	45-41939A1	1	69	Ball Bearing	18-1155	30-88957A1	1
29	Arandela	18-4267	12-29395	1	70	Aro tórico	18-7159	25-31534	1
30	Arandela	18-2340	12-31266	1	71	Cojinete de aguja	18-1158	31-30956	1
31	Retén aceite	26-89236	18-2009	1	72	Diabolo	18-2191	73020A14	1
32	Casquillo	18-2154	23-30617A2	1	73	Chaveta	N/D	28-30281	1
33	Aro tórico	18-7153	25-25439	1	74	Retén aceite	18-2002	26-76868	2
34	Arandela	N/D	12-27880	1	75	Arandela	18-2299	14-79447	1
35	Clip retención	18-4295	53-29641	1	76	Tuerca	18-3751	79448	1
36	Eje acero inoxidable	18-2150	77481-1	1	77	Arandela	18-4220	13171, 77987	1
37	Tachon (1-31/32")	N/D	16-56298	2	78	Arandela de continuidad	NSS	13-423511	1
38	Tachon (3 - 3/8")	N/D	16-562972	1	79	Arandela de cierre	18-3714	12-31211A2	1
39	Tachon (3 - 3/16")	N/D	16-46911	1	80	Arandela	18-3200	14-31210,	
40	Tachon (3 - 1/4")	N/D	16-69501	2				14-816629	1
41	Retén paso aceite	18-2944	26-45577	1	81	Tuerca	18-3700	11-52707	1

AR Se requiere

NSS No se vende por separado

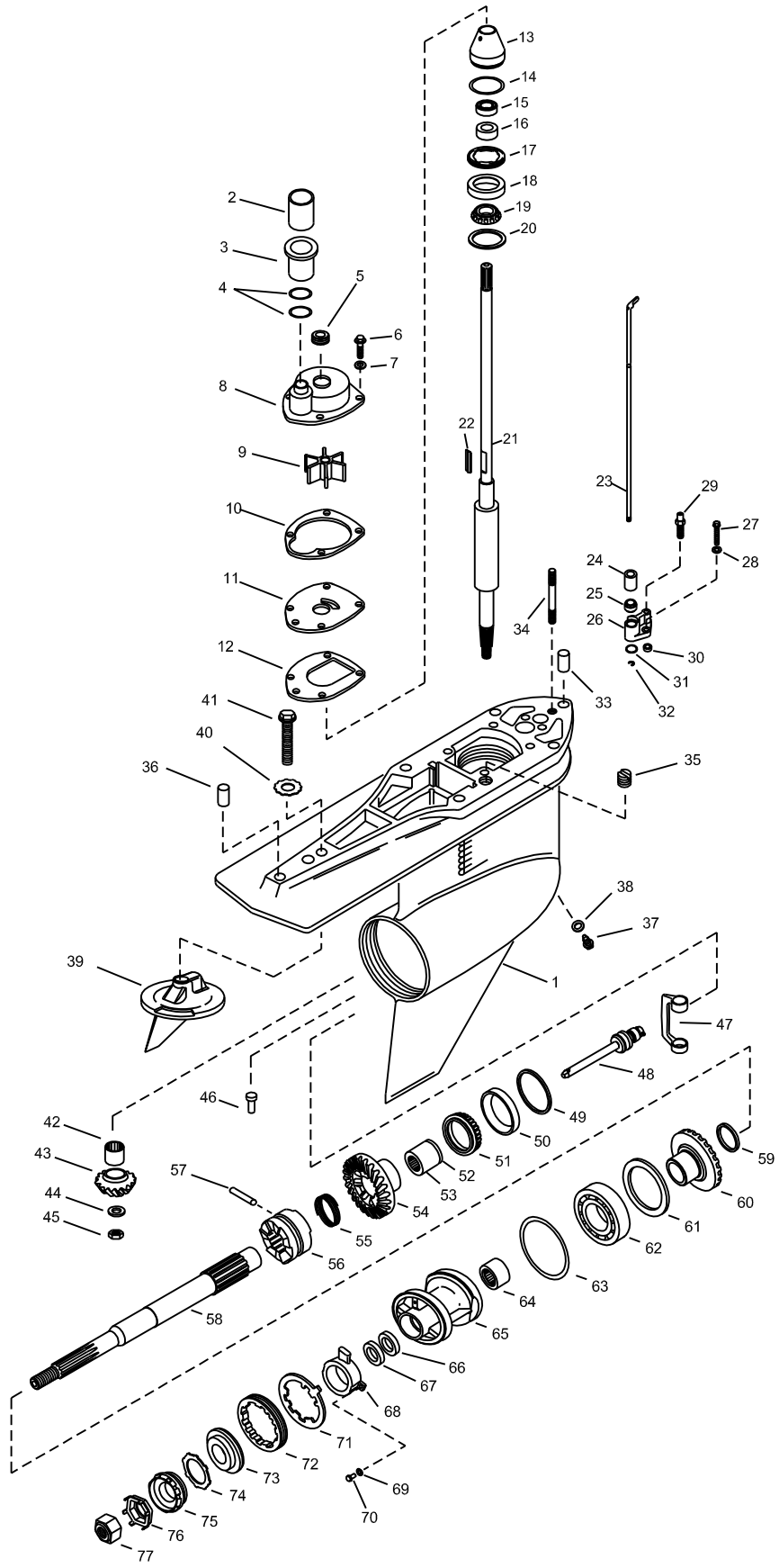

Fig #	Descripción	Ref #	O.E.M. #	Cant	Fig #	Descripción	Ref #	O.E.M. #	Cant.
1	Carcasa	18-2415	1623-815822A36	1	37	Tornillo drenaje	18-2375	22-67892A1	1
2	Manguito casquillo	—	23-816573	1	38	Junta	18-2945	12-19183	1
3	Acoplamiento	18-3151	816597A1	1	39	Ánodo timón	18-6016	76214A5	1
4	Aro tórico	18-7420	25-21836	2	40	Arandela, ánodo montaje	—	13-806210	1
5	Retén	18-2599	26-816575A2	1	41	Tornillo, ánodo montaje	—	10-806327	1
6	Tornillo, 10-32 X 5/8	NSS	10-816928	4	42	Cojinete piñón	18-1117	31-42647A1	1
7	Arandela	NSS	13-69432	4	43	Piñón	18-2206	43-828072A2	1
8	Cuerpo bomba de agua	18-3147	817275A1	1	44	Arandela	18-2343	12-92721	1
9	Impulsor	18-3056	47-43026-2	1	45	Tuerca	18-3719	11-35921	1
10	Junta	18-2563	27-817277	1	46	Pin	—	17-37972-1	1
11	Platina desgaste	18-3122	817276	1	47	Leva	18-2130	76865	1
12	Junta	18-2564	27-43033-1	1	48	Pasador	18-2286	818349A1	1
13	Retén	18-2354	821759A2	1	49	Grueso	18-2285	15-47397A1	1
14	Aro tórico	18-7176	25-90011	1	50 & 51	Cojinete	18-1159	31-35928A1	1
15	Retén	18-2013	26-16977	1	52	Clip retenedor	NSS	—	1
16	Retén	18-2014	26-89238	1	53	Cojinete agujas	18-1157	31-30895	1
17	Tuerca	18-2346	824519	1	54	Piñón	18-2206	43-828072A2	1
18 & 19	Cojinete (1.50-1.65 Ratio)	18-1143	31-36387A1	1	55	Muelle	18-2348	24-30893	1
	Cojinete (1.47-1.62 Ratio)	18-1193	31-33138A1	1	56	Trinquete embrague	18-2202	52-824112	1
					57	Bulón trinquete	18-2357	17-30632	1
					58	Eje hélice	18-2166	44-824110	1
20	Grueso	18-2294	15-42637A1	1	59	Espaciador	—	23-824108	1
21	Eje (1:47 & 1:62)	18-2331	45-853648	1	60	Piñón	18-2206	43-828072A2	1
	Eje (1:50 & 1:65)	18-2261	45-816919	1	61	Arandela	18-2342	681001	1
	Eje (1:84 & 1:98)				62	Rodamiento bolas	18-1155	30-88957A1	1
	Antiguos usar con:	—	45-816472	1	63	Aro tórico	18-7159	25-31534	1
22	Impulsor chaveta	18-3293	28-43037	1	64	Cojinetes	18-1158	31-30956	1
23	Eje	18-2320	815919A1	1	65	Cojinete diablo	18-2376	818763A10	1
24	Casquillo	18-2349	23-67370	1	66	Retén	18-2002	26-14077	1
25	Retén	18-2009	26-89236	1	67	Retén	18-2076	26-12224	1
26	Alojamiento retén	18-2353	23-815921A21	1	68	Ánodo	18-6093	806105A1	1
27	Tornillo, 10-32 X 5/8	NSS	10-806290	2	69	Tornillos	—	13-69432	2
28	Arandela	NSS	13-69432	2	70	Arandela de seguridad	—	10-806290	2
29	Conector velocímetro	—	NSS	1	71	Arandela	18-2298	14-18323	1
30	Aro tórico	18-7440-1	25-36318	1	72	Tuerca cierre	18-3751	79448	1
31	Aro tórico	18-7440-1	25-36318	1	73	Arandela	18-4220	13171	1
32	Aro retenedor	18-4295	53-29641	1	74	Arandela de continuidad	NSS	13-42351-1	1
33	Pin centrador	—	17-43044	1	75	Arandela	18-3714	12-31211A2	1
34	Tachon	—	16-57984	1	76	Arandela cierre	18-3200	14-31210	1
35	Retén	18-2944	26-45577	1	77	Tuerca hélice	18-3700	11-52707	1
36	Pin centrador	—	17-43044	1		Kit retenes (No dibujado)	18-2646-1	26-816575A3	1

NSS No se vende por separado



18-2292
KIT DE GRUESOS
 Transmisión
 Reemplaza: 15-35980A1
 Contiene (1) cada
 .002, .003, .005, .006, .010, .025
 Para: Mercruiser Vazer



18-2293
KIT DE GRUESOS
RODAMIENTO SUPERIOR
 Reemplaza: 15-36178A1, 15-36178A02,
 15-39899A1, 15-23097A1
 Contiene (1) cada .002, .003, .015
 (2) cada .010
 Para: Mercruiser Vazer



18-2294
KIT DE GRUESOS
Rodamiento inferior del eje
 Reemplaza: 15-8M0063267, 15-42637A1
 Contiene (1) cada
 .002, .003, .005, .010, .020
 Para: Mercruiser Vazer



18-2295
KIT DE GRUESOS
Rodamiento inferior del eje
 Reemplaza: 15-57007A1, 15-33143A1
 Contiene (1) cada
 .002, .003, .005, .010, .020
 Para: Mercruiser Vazer

GRUESOS

REF #	TAMAÑO	O.E. #
* 18-2282	Kit	15-32563A1 Para: Mercruiser Vazer
* 18-2283	Kit	15-45691A1
* 18-2284	Kit	15-31535A1
* 18-2285	Kit	15-35931A1, 15-47397A1
18-2296	.055	15-71013, 15-45811



- * 18-2282 (1) .002, .003, .005, .010, .025
- * 18-2283 (1) .002, .003, .005, .010
- * 18-2284 (1) .002, .003, .005, .010, .020
- * 18-2285 (1) .002, .003, .005, .010, .020

APLICACIÓN KITS DE GRUESOS

HP	Número serie	Rodamiento a kit tapa superior	Alojamiento eje	Transmisión	Espaciador transmisión	Alojamiento piñones	Piñón marcha atrás	Piñón adelante
120/140	2062141 hasta 2791956	18-2282 ②	18-2293	18-2292	18-2296	18-2295	18-2284 ⑤	18-2285
120/140	2791957 hasta 4893634	18-2283 ④	18-2293	18-2292	18-2296	18-2295	18-2284 ⑤	18-2285
120/140	4893635 hasta 6225576	18-2283	18-2293	18-2292	18-2296	18-2295	—	18-2285
160	2065190 hasta 2763441	18-2282 ②	18-2293	18-2292	18-2296	18-2295	18-2284 ⑤	18-2285
165	2763442 hasta 4890459	18-2283 ④	18-2293	18-2292	18-2296	18-2295	18-2284 ⑤	18-2285
165	4890460 & SUP	18-2283	18-2293	18-2292	18-2296	18-2295	—	18-2285
888	3106717 & SUP	18-2283 ③	18-2293	18-2292	18-2296	18-2295	18-2284 ⑤	18-2285
898/228	4782330 hasta 4898729	18-2283	18-2293	18-2292	18-2296	18-2295	18-2284 ⑤	18-2285
898/228	4898730 hasta 6225576	18-2283	18-2293	18-2292	18-2296	18-2295	—	18-2285
225-S	3856268 hasta 4200499	18-2283	18-2293	18-2292	18-2296	18-2295	18-2284 ⑤	18-2285
233	4200500 & SUP	18-2283	18-2293	18-2292	18-2296	18-2295	18-2284 ⑤	18-2285
250	4791300 hasta 4898729	18-2283	18-2293	18-2292	18-2296	18-2295	18-2284 ⑤	18-2285
260	4898730 hasta 6225576	18-2283	18-2293	18-2292	18-2296	18-2295	—	18-2285
470	4208730 hasta 4893934	18-2283	18-2293	18-2292	18-2296	18-2295	18-2284 ⑤	18-2285
470	4893835 hasta 6225576	18-2283	18-2293	18-2292	18-2296	18-2295	—	18-2285
485	4893835 & SUP	18-2283	18-2293	18-2292	18-2296	18-2295	—	18-2285
R/MR/Alpha One	6225577 & SUP (R)	18-2283	18-2293	18-2292	18-2296	18-2295	—	18-2285
R/MR/Alpha One	6225577 & SUP (MR)	18-2283	18-2293	18-2292	18-2296	18-2294	⑥	18-2285
Alpha Gen II	D494569 hasta F679999	18-2283	18-2293	18-2292	18-2296	18-2294	⑥	18-2285
Alpha Gen II	F680000 & SUP	18-2282		18-2293	18-2292	18-2296	18-2294⑥	—

② S/N #2187468 & Inf. usar 18-2293 ③ S/N #4433200 & SUP sólo ④ S/N #4530702 & SUP sólo ⑤ Kit ⑥ Sólo contra rotación

18-2400
PARTE INFERIOR
 Reemplaza: 1623-815822A53,
 1623-815822A5,
 1623-815822A32,
 1623-815822A43
 Para: Ratios 1.47, 1.62, 1.81 & 1.94
 Para: Gen II (1998 & sup) 0L100040 & sup



18-2411
ALOJAMIENTO
PARTE SUPERIOR
 Reemplaza: 1547-861063A4
 Para: Gen II superior (1998-sup), 0L100040-sup, 1.47:1 Ratio/Gen II superior (1998-sup) 0L100040-sup, 1.62/2.00:1 Ratio's/Gen II superior (1998-up), 0L100040-sup, 1.81:1 Ratio/Gen II superior (1998-sup), 0L100040-sup, 1.94/2.40:1 Ratios
 Usado con: 18-2416, 18-2417, 18-2418, 18-2419 Carcasas superiores completas





18-2415
ALOJAMIENTO
 Reemplaza: 1623-815822A36
 Para: Ratios 1.47, 1.62
 Gen II (1998 & sup), (0L100040 & sup)
 Usado con: 18-2400 carcasa inferior completa



18-2416
PARTE SUPERIOR
 Reemplaza: 1547-815930A6, 1547-861063A12, 1547-815930A16
 Para: Alpha Gen II (1991 & SUP) para engranajes ratios 1.47:1, 1.50:1.
 Usado con 18-2411 Alojamiento



18-2417
PARTE SUPERIOR
 Reemplaza: 1547-815930A5, 1547-861063A10, 1547-815930A15
 Para: Alpha Gen II (1991 & SUP) para engranajes ratios 1.62:1, 1.65:1, 2.0:1.
 Usado con: 18-2411 alojamiento parte superior



18-2418
PARTE SUPERIOR
 Reemplaza: 1547-815930A4, 1547-861063A8, 1547-815930A14
 Para: Gen II (1991 & SUP) para engranajes ratios 1.81:1, 1.84:1.
 Usado con: 18-2411 Alojamiento



18-2419
PARTE SUPERIOR
 Reemplaza: 1547-815930A3, 1547-861063A6, 1547-815930A13
 Para: Alpha Gen II (1991 & SUP) para engranajes ratios 1.98:1 y 2.40:1
 Usado con: 18-2411 Alojamiento



18-2450
UNIDAD SUPERIOR COMPLETA
 Reemplaza: 1547-9412A20, 1547-3917A13, 1547-3917A21,
 1547-3917A32, 1547-3917A37, 1547-5523A2, 1547-5523A9,
 1547-5523A12, 1547-5523A68, 1547-8265A15, 1547-9412A30,
 1547-9412A35
 Para: Alpha I
 1.5:1/1.47:1



18-2451
UNIDAD SUPERIOR COMPLETA
 Reemplaza: 1547-9412A21, 1547-3917A4, 1547-3917A8,
 1547-3917A16, 1547-3917A30, 1547-3917A38,
 1547-5523A8, 1547-5523A11, 1547-8265A16
 Para: Alpha I
 1.65:1/1.62:1



18-2452
UNIDAD SUPERIOR COMPLETA
 Reemplaza: 1547-9412A22, 1547-5523A67, 1547-8265A17,
 1547-9412A36
 Para: Alpha I
 1.84:1/1.81:1



18-2453
UNIDAD SUPERIOR COMPLETA
 Reemplaza: 1547-9412A23, 1547-5523A49, 1547-5523A67,
 1547-8265A17
 Para: Alpha I
 1.98:1/1.94:1

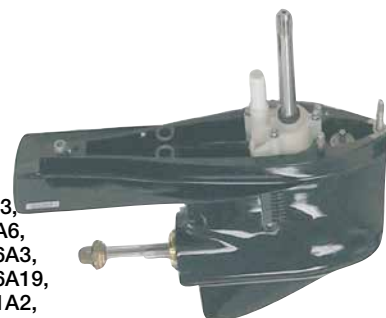

18-2443
PARTE INFERIOR
 Reemplaza: 1623-8951A43,
 1623-4110A4, 1623-4110A6,
 1623-4110A13, 1623-5356A3,
 1623-5356A18, 1623-5356A19,
 1623-5356A20, 1623-8951A2,
 1623-8951A14, 1623-8951A19,
 1623-8951A23
 Para: R/MR/ALPHA 1

18-2401

CARCASA INFERIOR

Reemplaza: 1623-8951A27,
1623-8951A37, 1623-8951A5, 1623-8951A15

Para: MR/ALPHA Estilo
Tamaño diámetro 3.2635-3.2650. Incluye Rodamiento de rodillos cónicos para no-tractor 14/28 o 17/28 marchas. Al instalar engranajes nuevos utilice 18-2206-1 kit de engranajes que incluye rodamiento de rodillos cónicos para tractor 18-1156 13/21 marchas.



18-2358

KIT REPARACIÓN UNIDAD SUPERIOR

Reemplaza: 43-803102T1
Para: 20-22 dientes: 1.50:1 (1.47:1)
Sólo para aplicaciones Gen II número de serie hasta OK999999



18-2363

KIT REPARACIÓN UNIDAD INFERIOR

Reemplaza: 43-803118T1
Para: 20-24 dientes: 1.98:1 (1.94/2.40:1)
Sólo para aplicaciones Gen II número de serie hasta OK999999



18-2364

KIT REPARACIÓN UNIDAD SUPERIOR

Reemplaza: 43-803119T1
Para: 24-24 dientes: 1.65:1 (1.62:1)
Sólo para aplicaciones Gen II número de serie hasta OK999999



18-2365

KIT REPARACIÓN UNIDAD SUPERIOR

Reemplaza: 43-803120T1
Para: 17-19 dientes: 1.84:1 (1.81:1)
Sólo para aplicaciones Gen II número de serie hasta OK999999



18-6350K

KIT REPARACIÓN UNIDAD SUPERIOR

Reemplaza: 43-803104T1
Para: Gen II (1998 & sup)(S/N OL100040 & sup)
1.62:1 y 2.00:1 Ratio



18-6351K

KIT REPARACIÓN UNIDAD INFERIOR

Reemplaza: 43-803103T1
Para: Gen II (1998 & sup)(S/N OL100040 & sup)
1.47:1 Ratio



18-6352K

KIT REPARACIÓN UNIDAD SUPERIOR

Reemplaza: 43-803106T1
Para: Gen II (1998 & sup)(S/N OL100040 & sup)
1.94:1 y 2.40:1 Ratio



18-6353K

KIT REPARACIÓN UNIDAD INFERIOR

Reemplaza: 43-803105T1
Para: Gen II (1998 & sup)(S/N OL100040 & sup)
1.81:1 Ratio



18-2201

KIT ENGRANAJES SUPERIOR

Reemplaza: 43-18410A2,
43-18411A2, 43-59832A2, 43-59832A4
Incluye: (1) 18-1142
Mercuriser #31-32573A1
(1.5:1 Ratio)
(Engranaje = 22 dientes Engranaje = 20 dientes)
Para mayoría V-8 Drives y Gen II (S/N K999999 & post)



Modelo dirección	Desde.	S/N Hasta.	S/N	Modelo dirección	Desde.	S/N Hasta.	S/N
225	3856268	4200499		888	3106717		& SUP
260	4898730	6225576		V8R/MR/AlphaOne	6225577		& SUP
898/228	4782330	6225576					



18-2203
KIT ENGRANAJES SUPERIOR
 Reemplaza: 43-45814A5, 43-55765A2, 43-55765A3
 (1.65:1 Ratio) (Engranaje = 24 Dientes Engranaje = 24 Dientes)
 Para: 6 Cil. En línea S/N K999999 & POST



18-2204
KIT ENGRANAJES SUPERIOR
 Reemplaza: 43-75325A3, 43-75325A2
 (1.84:1 Ratio)
 (Engranaje = 17 dientes Engranaje = 19 dientes)
 Para: V-6 and 470/485 (4 Cyl. etc.) y Gen II
 (S/N K999999 & Inf.)



18-2205
KIT ENGRANAJES SUPERIOR
 Reemplaza: 43-55778A3, 43-55766A2, 43-55766A3
 (1.98:1 Ratio)
 (Engranaje = 20 dientes Engranaje = 24 dientes)
 Para: 120/140 (S/N 2791957 & SUP) y Gen II
 (S/N K999999 & inf)



18-6350
KIT ENGRANAJES SUPERIOR
 Reemplaza: 43-853640A2, 43-821823A1
 Para: Gen II superior (1998-sup), 0L100040-sup,
 1.62/2.00:1 Ratios (24-24 dientes)
 Usado con: 18-2417 Carcasa superior completa



18-6351
KIT ENGRANAJES SUPERIOR
 Reemplaza: 43-853641A2
 Para: Alpha I (Gen II) (1998-sup), 0L100040-sup,
 1.47:1 Ratio (20-22 dientes)
 Usado con: 18-2416 carcasa completa superior



18-6352
KIT ENGRANAJES SUPERIOR
 Reemplaza: 43-853642A2
 Para: Alpha I (Gen II) (1998-sup), 0L100040-sup,
 1.94:1, 2.40:1 Ratios (20-24 dientes)
 Para: Mercruiser Vazer
 Usado con: 18-2411 Alojamiento,
 18-2419 Carcasa superior completa



18-6353
KIT ENGRANAJES SUPERIOR
 Reemplaza: 43-853643A2
 1.81 Ratio superior Gear Set, 17-19 dientes
 Para: Alpha I Gen II 1998-sup/0L100040-sup
 Para: Mercruiser Vazer

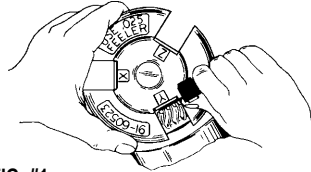

FIG. #1

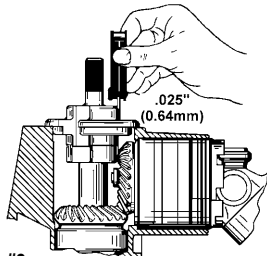

FIG. #2

FIGURAS #1 - #2

Proporciona dos vistas diferentes del kit de engranajes superior siendo ajustados con las herramientas de instalación.

FIGURAS #3 - #4

Proporciona las mismas vistas de la instalación del kit de engranajes.

NOTA:

La instalación no se podrá efectuar correctamente sin la herramienta Mercury. Una instalación inapropiada causará fallo de los engranajes. La herramienta .025 de la FIG #2 y FIG #4 está indicado cuando la de .026 no se adapta pero la de .025 si.

Siga paso a paso el manual de instalación. Vea el manual sierra ref. SE-62

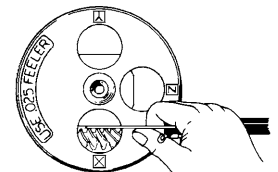

FIG. #3

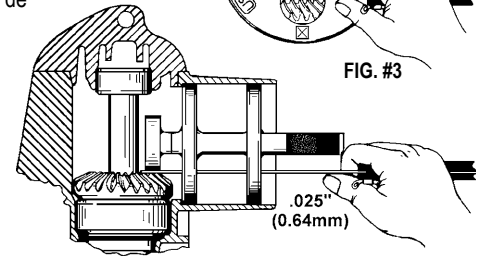

FIG. #4



18-2256
KIT ENGRANAJES SUPERIOR
 Reemplaza: 43-803116T1
 Mayoría V-8 (1.5:1 Ratio)

— CONTIENE —

Ref #	Descripción	O.E. #	cant.
18-2201	kit unidad superior	43-18410A2	1
18-2648	Kit retén	26-32511A2	1
18-2619-1	Juego juntas	27-94996A1	1
18-2820	Junta	27-64818	1
18-2743	Junta	27-94996-2	1
18-1160	Cojinete	31-35988A2	1
18-1165	Cojinete	31-61100A1	1
18-1142	Cojinete	31-35990A1	1

— CONTIENE —

Ref #	Descripción	O.E. #	Cant.
18-2203	Kit engranajes	43-45814A5	1
18-2648	Kit retén	26-32511A2	1
18-2619-1	Kit juntas	27-94996A1	1
18-2820	Junta	27-64818	1
18-1160	Cojinete	31-35988A2	1
18-1161	Cojinete	31-35990A1	1
18-1165	Cojinete	31-61100A1	1
18-2743	Junta	27-94996-2	1

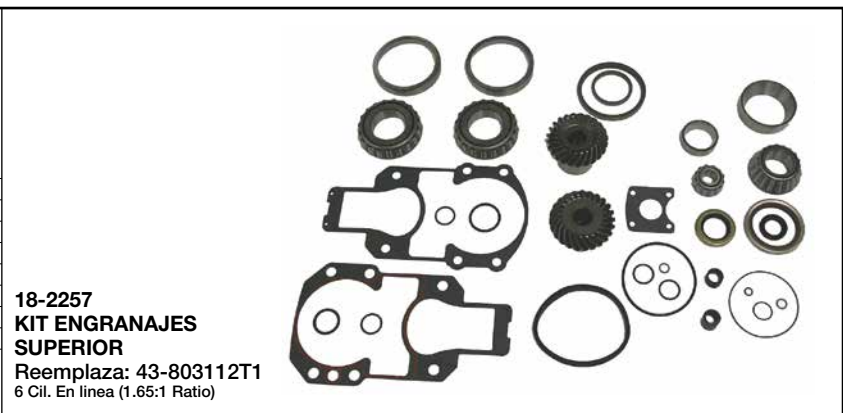

**18-2257
KIT ENGRANAJES
SUPERIOR**
Reemplaza: 43-803112T1
6 Cil. En línea (1.65:1 Ratio)

— CONTIENE —

Ref #	Descripción	O.E. #	Cant.
18-2204	Kit engranajes	43-75325A3	1
18-2648	Kit retén	26-32511A2	1
18-2619-1	Kit juntas	27-94996A1	1
18-2820	Junta	27-64818	1
18-1160	Cojinete	31-35988A2	1
18-1161	Cojinete	31-35990A1	1
18-2743	Junta	27-94996-2	1
18-1165	Cojinete	31-61100A1	1

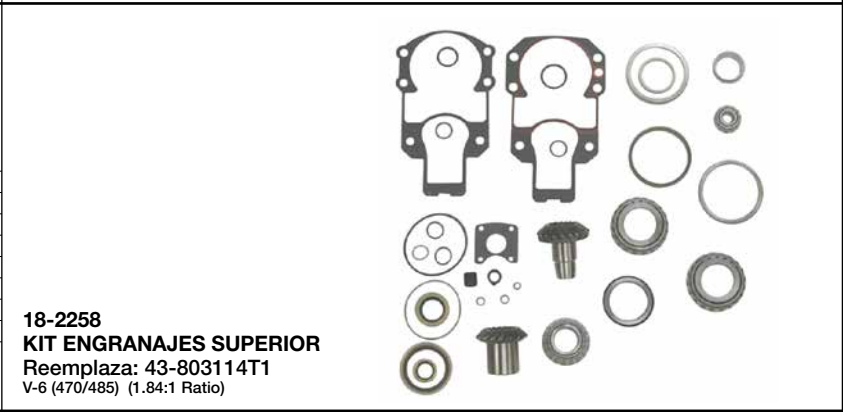

**18-2258
KIT ENGRANAJES SUPERIOR**
Reemplaza: 43-803114T1
V-6 (470/485) (1.84:1 Ratio)

— CONTIENE —

Ref #	Descripción	O.E. #	Cant.
18-2205	Kit engranajes	43-55778A3	1
18-2648	Kit retén	26-32511A2	1
18-2619-1	Juego juntas	27-94996A1	1
18-2820	Juntas	27-64818	1
18-1160	Cojinete	31-35988A2	1
18-1161	Cojinete	31-35990A1	1
18-1165	Cojinete	31-61100A1	1
18-2743	Junta	27-94996-2	1



**18-2259
KIT ENGRANAJE
SUPERIOR**
Reemplaza: 43-803101T1
120/140 (1.98:1 Ratio)



**18-2125
EJE CARDAN TRASERO**
Reemplaza: 39384, 46020, 460201, 46020T, 4602002, 46020002,
Para todos #1/ALPHA Units (S/N 1684188 - OK999999)



**18-2146
EJE CARDAN DELANTERO**
Reemplaza: 20175, 59830A1, 59830A7
Para todos #1, R, MR, Alpha I, Alpha I Gen II, Bravo & Blackhawk



**18-6400
EJE CARDAN TRASERO**
Reemplaza: 12784, 12784T
Para: Bravo (OM111207 & post) y Blackhawk



**18-6403
EJE CARDAN TRASERO**
Reemplaza: 865492T, 864282T
Para: Alpha I Gen II 0L949779 & SUP,
Para: Mercruiser Vazer



**18-6405
EJE CARDAN DELANTERO**
Reemplaza: 865491A01, 864281A01
Para: Alpha I Gen II 0L949779 & SUP (GKN estilo)
Para: Mercruiser Vazer



**18-1709
CARDAN COMPLETO**
Reemplaza: 862129A1, 862129, 862130, 862131, 865425A03
Para: Bravo X (OM100001 - OM750174) (2000-03)
Meritor Style: Bravo XR/X2 (OM100001 - sup) (2000-sup)
No se adapta a transmisiones Bravo con cardan grande y transom integrado (862129T3)



18-6401
CARDAN COMPLETO
 Reemplaza: 12784A10, 12784A4
 Para Bravo I, II, III (OB664190 - sup)
 (1998-05)



18-6402
CARDAN COMPLETO
 Reemplaza: 864281A2, 864281A7
 Para: Alpha I (Gen II) (1998 & sup) (OL100040 & sup) GKN Estilo
 Para: Mercruiser Vazer



18-9218
CARDAN COMPLETO
 Reemplaza: 814819A2, 59830A5, 59829A1
 Para todos #1, R/MR/ALPHA Gen II
 OK999999 & post (1971-97)



18-2128
RÓTULA CARDAN
 Reemplaza: 39383, 39383T, 393831
 (Rockwell)
 Para IA/IB/IC & EZ, MC-I, R, MR, Alpha One, Gen II
 (OL949778 & post), Bravo (OM111207 & post),
 MC II & TS



18-1711
CRUCETA CARDAN
 Reemplaza: 862132, 862132T
 Para: Bravo One, Two, & Three (Todos Ratios), Bravo
 One X/Two X, Three X (todos Ratios), Bravo One XR/
 XZ(Todos Ratios), Bravo One XR Sportmaster (Todos
 Ratios) & Integrated Transom



18-2097
CRUCETA CARDAN
 Permalube
 Reemplaza: 8055361, 805536A1, 805536A2
 Para: Generation II F680000 & SUP



18-2104
CRUCETA CARD.
 Heavy Duty
 Reemplaza: 75832, 75832A2, 75832T,
 758321, 75832T1, 75832A1, 75832A3,
 58749, 41431, 36312
 Incluye engrasadores rectos y de 90° (Rockwell)
 Para todos #1 y ALPHA I Units S/N 1684188-B418818.
 También TR/TRS y II SSM.



18-2174
CRUCETA
 Heavy Duty
 Reemplaza: 36312, 41431, 58749,
 75832, 75832T, 75832A1, 75832A2,
 75832A3, 758321, 75832T1
 Incluye engrasadores rectos y de 90° (Rockwell)
 Para unidades ALPHA I S/N B418819 & en adelante.
 También para ALPHA I SS & BRAVO



18-6406
KIT CRUCETA CARDAN
 Reemplaza: 865496A01, 865493A01,
 865510T, 865496A01, 865511T
 GKN nuevo estilo con clips exteriores.
 Se adapta: Alpha I Gen II OL949779 & SUP, Bravo
 OM111208 & SUP
 Para: Mercruiser Vazer



18-8311
KIT DE RECONSTRUCCIÓN TRANSOM
 Para: Alpha One



18-8312
KIT DE RECONSTRUCCIÓN TRANSOM
 Para: Gen II



18-8313
KIT DE RECONSTRUCCIÓN TRANSOM
 Para: Bravo



18-21001
COJINETE
 Reemplaza: 30-60794A2, 30-60794A4,
 30-879194A02
 No engrasable
 Para: MC-1, R, MR y Alpha(1974-97),
 Gen II(1991-97), Bravo I/II/III (1988-95)



18-21006
COJINETE
 No engrasable
 Reemplaza: 30-862540T1, 30-862540A3,
 30-862540A04, 30-879194A01
 Para: Gen II (1998-10), Bravo I/II/III & X/XP/XZ (1996-10)



18-21005
RODAMIENTO
 Reemplaza: 30-862540A3, 30-862540T1,
 30-862540A04, 30-879194A01
 Engrasable
 Para: Todos Bravos, Alpha One Gen II (1998-sup)



18-21005K
KIT RODAMIENTO Y RETÉN
 Reemplaza: 30-862540A3, 30-862540T1,
 30-862540A04, 30-879194A01
 Engrasable
 Contiene (1) cada uno de 18-2094 & 18-21005
 Para: Gen II (1998-sup) y todos Bravo



18-2101
RODAMIENTO CARDAN
 Reemplaza: 30-36418, 30-36056, 36147
 Engrasable
(Enlace correa)



18-2100
RODAMIENTO CARDAN
 Reemplaza: 30-60794A4, 30-60794A2,
 30-879194A02
 Engrasable
(enlace correa)
 Para: Mercruiser- 120HP / 140HP
 (2791957-6225576) (con indicador de trim), 165HP
 (2763442 & sup), 225S (3856268-4200499), 228HP
 (4782330 & sup), 233HP (4200500 & sup), 250HP
 (4791300 & sup)



18-2100K
KIT RODAMIENTO Y RETÉN
 Reemplaza: 30-60794A2, 30-60794A4,
 30-879194A02
 Engrasable
 Contiene (1) cada uno de 18-2094 & 18-21001
 Para: 1, R, MR y Alpha (1974-97)



18-73131
PIVOTE
 Reemplaza: 98230A1
 Para: Mercruiser Alpha/Gen II/Bravo I/II/III & Vazer



18-1705
TORNILLO
 Reemplaza: 77123, 77123A1,
 65547
 (con engrasador) Para transom
 Para: Alpha, Alpha Gen II
 S/N 0M815638 & inf



18-1706
TORNILLO
 Reemplaza: 10-86801
 Para rodamiento cardan
 Para: Alpha Gen II S/N 0M85639 & SUP
 todos los Modelos Bravo con trim sender



18-2381
TAPA PARTE SUPERIOR
 Reemplaza: 94998A1, 94998A2,
 94998A3, 94998A4
 S/N 6225577 & últimos Alpha I, excepto
 Gen II



18-2382
TAPA PARTE SUPERIOR
 Reemplaza: 828692A1, 18312A3
 Para: Gen II S/N F680000 & SUP

APLICACIONES RODAMIENTO

Modelo	Año rango	Núm. Serie	Rodamiento	Modelo	Año rango	Núm. Serie	Rodamiento
I	1963	1534570-1684187	30-32537T	250 / 260	1977-1982	1791300-6225576	18-21001
IA	1964	1684186-1777798	18-2101	R / MR / ALPHA I	1983-1990	6225577 & SUP	18-21001
IB	1964	1684188-1777798	18-2101	ALPHA I SS	1986-1989	A545004 & SUP	18-21001
IC	1964	1684188-1777798	18-2101	ALPHA I GEN II	1991-1997	D469859-K999999	18-21001
EZ-SHIFT	1964	1684188-1777798	18-2101	ALPHA I GEN II	1998-2010	L100040 & SUP	18-21001
120 / 140	1967-1973	2062141-3780849	18-2101	BRAVO I	1988-1995	B664190-F729999	18-21001
120 / 140	1974-1982	3780850-6225576	18-21001	BRAVO II	1988-1995	B664190-F729999	18-21001
470 / 485	1976-1982	4208730-6225575	18-21001	BRAVO III	1988-1995	B664190-F729999	18-21001
160 / 165	1967-1973	2065190-3780849	18-2101	BRAVO I	1996-2010	F730000 & SUP	18-21006
165	1974-1981	3780850 & SUP	18-21001	BRAVO II	1996-2010	F730000 & SUP	18-21006
888	1971-1973	3106717-3784374	18-2101	BRAVO III	1996-2010	F730000 & SUP	18-21006
888	1974-1977	3784375 & SUP	18-21001	X / XR / XZ	1996-2010	F730000 & SUP	18-21006
225 / 233	1974	3856268 & SUP	18-21001	BLACKHAWK	1994-1995	F186717 & SUP	18-21001
898 / 228	1977-1982	4782330-6225576	18-21001	II	1964-1969	1602186-2671321	18-2101



18-2179
EJE TRANSMISIÓN SUPERIOR
 Reemplaza: 45-55796





















18-2324
EJE TRANSMISIÓN SUPERIOR
 Reemplaza: 45-557961
 Para: Gen II (S/N F680000 & SUP),
 Mercruiser Vazer



18-3713
TUERCA
 Reemplaza: 11-22339, 11-
 97522, 11-36084, F1348, F1881
 5/8" - 18



18-3712
ARANDELA
 Reemplaza: 12-45810

 <p>18-3752 TUERCA RETENCIÓN ALOJAMIENTO EJE TRANSMISIÓN Reemplaza: 8168111, 8168112, 66071, 35992</p>	 <p>18-4296 SEPARADOR Reemplaza: 35983 (Alojamiento superior)</p>	 <p>18-0577 ASIENTO RETÉN Reemplaza: 66081A2, 35993A1, 66081A1, 66081A4</p>	 <p>18-3219 KIT REFRIGERACIÓN Reemplaza: 32489, 32489A2, 42724A3 Para: Merc I y Alpha I drives Modelos: I, 1A,1B, 1C, 1CEZ, 120, 140, 160, 165, 888, 898, 228, 225-S, 233, 250, 260, 470,485.R, MR, Alpha 18-3229 TORNILLO Reemplaza: 10-28668</p>
 <p>18-2322 EJE INTERMEDIO Reemplaza: 62104, 621041 Para: I y Alpha I</p>	 <p>18-2169 BRAZO DE CAMBIO Reemplaza: 45589A1, 45589A3</p>	 <p>18-3749 EJE SUPERIOR CAMBIO Reemplaza: 816685 Para: Alpha Gen II (1991-98)</p>	
 <p>18-2599 RETÉN Reemplaza: 26-816575A2 Para: ALPHA I GENERATION II</p>	 <p>18-2622 KIT CASQUILLOS ALOJAMIENTO CAMPANA Reemplaza: 23-79373A1, 23-805041A2, 27-45588, 27-79373</p>	 <p>18-3760 KIT COJINETE CAMPANA Reemplaza: 23-806036A1 Para: GEN II Serial # F680000 & SUP</p>	
 <p>18-2161 BRAZO CAMBIO Reemplaza: 45518A1, 45518A2, 45518A3</p>	 <p>18-2170 TORNILLO BRAZO CAMBIO Reemplaza: 10-45590, 10-8M0084649</p>	 <p>18-2162 CORREDERA CABLE CAMBIO CON TORNILLO Reemplaza: 33981, 33981T, 33981T1, 8507521, 8507522</p>	 <p>18-2162E CORREDERA CABLE CAMBIO TORNILLO Reemplaza: 33981, 33981T1, 8507521, 8507522 Cables extreme</p>
<p>Pack de 5</p>  <p>18-2163 18-2163-9① TORNILLO Reemplaza: Mercruiser 10-31700 GLM: 21090 Mallory: 9-72152</p>	<p>Pack de 5</p>  <p>18-2163E-9① TORNILLO Sólo para cables extreme</p>	 <p>18-2715 KIT VÁLVULA ACEITE Reemplaza: 24-17997A1 Para: Alpha I Generation II y Bravo I, II, y III Drives</p>	 <p>18-2724 GOMA CIERRE TRANSOM Reemplaza: 3713 Para: Alpha Gen II, Todos Bravo</p>

① Precio por pack

— CONTIENE —

Ref #	Descripción	O.E. #	Cant.
18-2619-1	Juego de juntas fueraborda	27-64818A3 27-94996A1,Q2	1
18-2100	Rodamiento	30-60794A2, 30-60794A4	1
18-2161	Brazo cambio	45518A2	1
18-2751	Fuelle unión	60932A4	1
18-2750	Fuelle escape	32734A3, 18654A1	1
18-2753-1	Fuelle cable cambio	74639	1
18-3601	Manguito	32-32461	1
18-3602	Manguito	32-41725-33	1
18-710-16-2	Brida	—	2
18-7314	Abrazadera inox	—	1
18-710-64-2	Abrazadera inox	—	1



**18-2601-1
KIT RETENES TRANSOM**
Reemplaza: 30-803097T1
R, MR, ALPHA 1 (1983-90) S/N 6225577 & SUP
ALPHA 1 SS (1986-89) S/N OA 545004 & SUP
*Cojinete engrasable

— CONTIENE —

Ref #	Descripción	O.E. #	Cant.
18-2100	Rodamiento	30-60794A4, 30-60794A2	1
18-2751	Fuelle union	60932A4	1
18-2760	Tubo escape	78458A1	1
18-3601	Manguito	32-32461	1
18-3602	Manguito	32-41725-33	1
18-2743	Junta	27-94996-2	1
18-2840	Junta	27-35982	1
18-7153	Aro	25-25439	1
18-7117	Aro	25-35027	1
18-710-16-2	Brida	—	2
18-7170	Aro	25-33504	1
18-710-24-2	Brida	—	1
18-2753-1	Fuelle cable cambio	74639	1
18-7321	Brida fuelle	54-38863	1



**18-8205
KIT RETENES TRANSOM**
Reemplaza: 30-803098T1
Para: 1, R, MR, Alpha 1 con tubo escape
*Cojinete engrasable

— CONTIENE —

Ref #	Descripción	O.E. #	Cant.
18-3602	Manguito	32-41725-33	1
18-710-16-2	Brida	—	2
18-710-24-2	Brida	—	1
18-2753-1	Fuelle cable cambio	74639	1
18-7321	Brida fuelle	54-38863	1
18-2100	Rodamiento	30-60794A4, 30-60794A2	1
18-2743	Junta	27-94996-2	1
18-2840	Junta	27-35982	1
18-7153	Aro	25-25439	1
18-7170	Aro	25-33504	1
18-7117	Aro	25-35027	1
18-2750	Fuelle escape	18654A1, 32734A3	1
18-2747	Fuelle dirección	816431A1	1



**18-8206-1
KIT RETENES TRANSOM**
Reemplaza: 30-803099T1
Para: Alpha 1 Gen II
*Cojinete engrasable

— CONTIENE —

Ref #	Descripción	O.E. #	Cant.
18-2753-1	Manguito fuelle	74639	1
18-2100	Cojinete cardán	30-862540A3	1
18-2756	Fuelles	86840A3	1
18-2750	Tubo escape	32734A3	1
18-2760	Tubo escape	78458A1	1
18-3603	Manguera agua	32-43437	1
18-2615	Outdrive Mounting Kit	16755A1	1



**18-8212-1
KIT RETENES TRANSOM**
Reemplaza: 30-803100T1
Para: Todos Bravos 1982 & sup
*Cojinete engrasable



**18-8213
KIT RETENES TRANSOM**
Reemplaza:
Mercuriser 30-803097T1
PARA: R, MR, Alpha 1 (1983-90) S/N
6225577-0D469858; Alpha 1 SS (1986-89)
S/N OA545004 & Sup
*Cojinete 18-21001



**18-8217
KIT RETENES TRANSOM**
Reemplaza:
Mercuriser 30-803098T1
PARA: R, MR, Alpha 1 (1983-90) con tubo
escape S/N 6225577-0D469858; Alpha 1 SS
(1986-89) con tubo escape S/N OA545004 &
stCojinete 18-21001



**18-8218
KIT RETENES TRANSOM**
Reemplaza:
Mercuriser 30-803099T1
PARA: Alpha 1 Gen II (1991 & sup) S/N
0D469859 & sup
*Cojinete 18-21006



**18-8219
KIT RETENES TRANSOM**
Reemplaza:
Mercuriser 30-803100T1
PARA: Bravo I/II/III (1988 & Sup)
S/N 0B664190 & sup; Blackhawk
(1994-95) S/N 0F186717 & sup
*Cojinete 18-21006



**18-2747
FUELLE**
Alpha 1, Gen II
Reemplaza: 816431A1



**18-2750
FUELLE**
Fuelle #1 Units, Gen II,
TRS, & Bravo I, II, III
Reemplaza: 32734, 32734A3, 18654A1
(Incluye abrazadera 18-7314)



**18-2751
FUELLE TRANSMISIÓN**
Todos las unidades #1 (S/N 3469428 & SUP)
Reemplaza: 60932A1, 60932A4
(Incluye abrazadera 18-710-72-2)



**18-2752
FUELLE TRANSMISIÓN**
Todas las unidades #1 sin reborde
(S/N 3443920 & post)
Reemplaza: 36223, 36223A1,
36223A2
(Incluye abrazadera 18-710-72-2)



**18-2753-
2D**
FUELLE CABLE CAMBIO
Todos #1, #2 unidades, Alpha, Bravo I, II, III
Reemplaza: 31659, 74639,
74639A2
(Incluye abrazaderas 18-7321)



**18-2756
FUELLE TRANSMISIÓN**
Reemplaza: 86840A3,
86840A05, 8M0062406
Para todos modelos Bravo y Blackhawk



**18-1710
ARO BRIDA INFERIOR**
Reemplaza: 862209, 86814
Para: Todos Bravo



**18-1728
ARO BRIDA INF**
Reemplaza: 816607
Para: Alpha One (GenII) (1991 y sup)



**18-2746
TUBO ESCAPE**
Reemplaza: 32-14358, 32-
14358T, 31-14358001
(4" tubo inferior)



**18-2748
TUBO ESCAPE**
Reemplaza: 32-44348, 32-
44348T, 31-44348001
(4" Tubo superior)



**18-2759
TUBO ESCAPE**
Reemplaza: 53114, 53114A1



**18-2760
TUBO ESCAPE**
Reemplaza: 78458, 78458A1
(Incluye abrazadera 18-7314)
Para: #1, Bravo I, II, III



**18-2761
TUBO ESCAPE**
3" D.I.
Reemplaza: 32-90949, 32-90949T



**18-2762
TUBO ESCAPE**
Reemplaza: 70981, 70981A3



**18-2770
TUBO ESCAPE**
Reemplaza: 32-807458T

① Referencias acabadas en "D" envasadas - Las referencias normales no envasadas

APLICACIONES FUELLES

Modelo	Años	Serie #	Fuelles escape	Fuelle Cable cambio	Fuelle Transmisión
I/1A/1B/1C & EZ	1963-1966	1534570-2065186	18-2750	18-2753-2	18-2752
120/140/160/165	1967-1972	2062141-3443920	18-2750	18-2753-2	18-2752
120/140/160/165	1972-1982	3469428-6225576	18-2750	18-2753-2	18-2751
888	1971-1972	3106717-3472477	18-2750	18-2753-2	18-2752
888	1973-1977	3472478 & sup	18-2750	18-2753-2	18-2751
225/233	1974-1977	3856268 & sup	18-2750	18-2753-2	18-2751
898/228/250/260	1977-1982	4782330-6225576	18-2750	18-2753-2	18-2751
R/MR/Alpha One	1983-1990	6225577 & sup	18-2750	18-2753-2	18-2751
R/MR/Alpha One	1983-1990	6225577 & sup	18-2760 ②	18-2753-2	18-2751
Alpha One Gen II	1991 & nuevos	0D469859 & sup	18-2750	18-2753-2	18-2747
Bravo I/II/III	1988 & nuevos	0B664190 & sup	18-2750	18-2753-2	18-2756
Bravo I/II/III	1988 & nuevos	0B664190 & sup	18-2760 ②	18-2753-2	18-2756
Blackhawk	1994-1995	0F18677 & sup	18-2750	18-2753-2	18-2756
Blackhawk	1994-1995	0F18677 & sup	18-2760 ②	18-2753-2	18-2756
II	1962-1969	1474909-2671321	—	18-2753-2	—
215H	1970	2782203-2909034	—	—	18-2752
215E	1970-1972	2909035-2915034	—	18-2753-2	18-2752
TR/TRS	1973-1993	3377316 & sup	—	—	18-2751

② Tubo

Pack. de 5



18-7321
18-7321-9②
ABRAZADERA FUELLE
 Reemplaza: 54-38863, 54-866507, 54-8M0090424

CUERPO CABLE

18-2159
 Reemplaza: 19543A2, 19543A4, 19543A8, 19543A10, 41951A1, 66065A1, 66069A2, 73679A2, 865436A02
 Usar en 18-2157, 18-2158 y sus repuestos de cable y tubo
 Mercuruiser sirga 73"



18-2189
 Reemplaza: 32992A1, 34086A1, 37611A1, 38399A2
 Usar con 18-2248
 Sirga 59"

18-2160
TUBO SOPORTE
 Reemplaza: 32-38377
 Reemplaza tubo en 18-2157, 18-2158 & 18-2159



18-2248
CONJUNTO CABLE INVERSON
 Reemplaza: 73723A1, 73723A01, 49518A1, 35187A1, 35187A2, 35187A4
 Mercuruiser #1 Drives S/N 1562900-6225576 para instalaciones a proa de alojamiento de campana. Nuevo modelo con cable trenzado blindado (sin tubo de soporte) 54" con kit de montaje.



18-2157
 Reemplaza:
 19543A2, 41951A1, 19543A8, 19543A10, 19543A4, 66065A1, 66069A2, 73679A2, 865436A02
 Mercuruiser 1 drives S/N 6225577 & SUP para instalaciones a popa del alojamiento campana. Modelo antiguo con cable trenzado y terminales soldados (Usa tubo guía).
18-2158
 Mercuruiser #1 Drives S/N 1562900-6225576 para instalaciones a proa del alojamiento de campana. Modelo antiguo con cable trenzado y terminales soldados (Usa tubo guía 18-2160) 63".



CONJUNTO CABLE INVERSON

18-2190
CONJUNTO CABLE INVERSON
 Reemplaza: 19543A2, 19543A4, 19543A8, 19543A10, 41951A1, 66065A1, 66069A2, 73679A2, 865436A02
 Mercuruiser 1 drives S/N 6225577 & SUP
 Para instalaciones a popa del alojamiento campana. Para uso en aplicaciones que utilizan cable con armazón trenzado (Sin tubo soporte). 63" con kit de montaje.



18-2190E
CONJUNTO CABLE INVERSON
 Reemplaza: 19543A4, 19543A10, 19543A8, 19543A2, 41951A1, 66065A1, 66069A2, 73679A2, 865436A02
 S/N 6225577 & SUP. Para instalaciones a popa del alojamiento campana. Para uso en aplicaciones que utilizan cable con armazón trenzado (Sin tubo soporte). 63" con kit de montaje. Conjunto cable inversor inferior- Alpha One (Gen II) (1991-97)
 Requiere 18-9806E (cable de cambio extreme) para completar la instalación



18-2145
CONJUNTO CABLE INVERSON
 Reemplaza: 815471A3, 815471A6, 85147A5, 865437A02, 43432A2, 19297A3

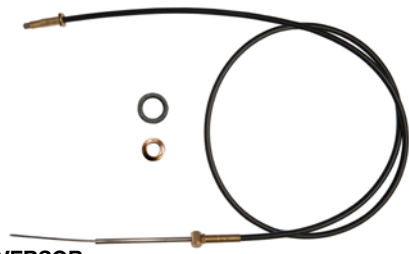

18-2145E
CONJUNTO DE CABLE INVERSON
 Reemplaza: 815471, A3, A6
 Bravo One, Two, & Three (Todos Ratios), Bravo One X/Two X, Three X (Todos Ratios), Bravo One XR/XZ (Todos Ratios), Bravo One XR Sportmaster (Todos Ratios) & Transom Integrados



18-9806E
VASO CABLE CAMBIO
 Instala y desmonta cables de cambio MC-I, R-MR, Alpha I, Alpha I Gen II drive unidades. Usar con 18-2190 y 18-2190E cables.



18-2149
TUBO GUÍA CABLE
 Reemplaza: 22879, 29880, 43433
 Para: Alpha & Bravo cables



Pack de 25
18-2303
18-2303-9①
TORNILLO RETENEDOR CABLE
 Reemplaza: 10-20518
 Para: #1R, MR, Alpha, Alpha I, Gen II & Bravo





18-3754
CABLE ANCLAJE
Reemplaza: 43436

Para: #1R, MR, Alpha, Alpha I, Gen II & Bravo

18-2600
KIT INFERIOR CABLE CAMBIO
- CONTIENE -

Ref #	Descripción	O.E. #	Cant.
18-2619-1	Juego juntas	27-94996A1	1
18-2753-1	Fuelle cable cambio	74639	1
18-2248	Conjunto cable cambio	73723A1	1
18-2162	Pasador y tornillo	33981T	1
18-2149	kit cable cambio	43433	1
18-2163	Tornillo pasador	10-31700	1
18-2743	Junta	27-94996-2	1
18-2820	Junta	27-64818	1
18-2843	Junta	27-94996	1

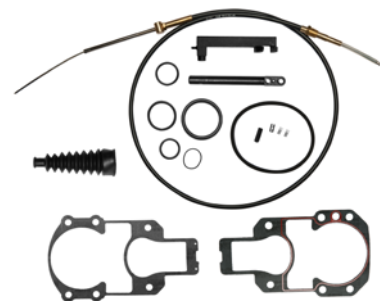

18-2603
KIT INFERIOR CABLE CAMBIO
Reemplaza: 19543T1, 19543T2, 865436A03
ALPHA I GENERACIÓN II

- CONTIENE -

Ref #	Descripción	O.E. #	Cant.
18-2619-1	Juego de juntas fueraborda	27-94996A1	1
18-2753-1	Fuelle cable cambio	74639	1
18-2190	Conjunto cable cambio	19543A4	1
18-2743	Junta	27-94996-2	1

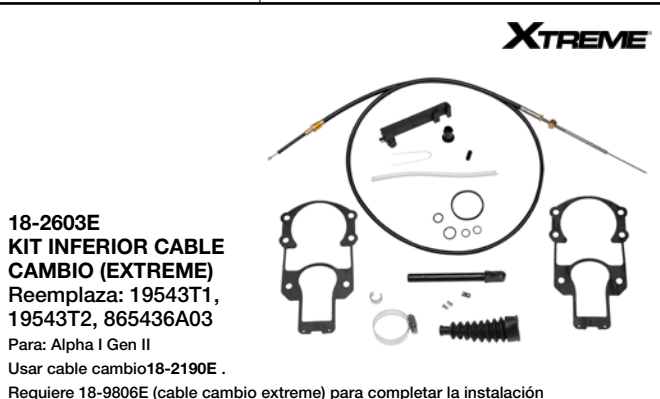

18-2603E
KIT INFERIOR CABLE CAMBIO (EXTREME)
Reemplaza: 19543T1, 19543T2, 865436A03

Para: Alpha I Gen II
Usar cable cambio 18-2190E.
Requiere 18-9806E (cable cambio extreme) para completar la instalación

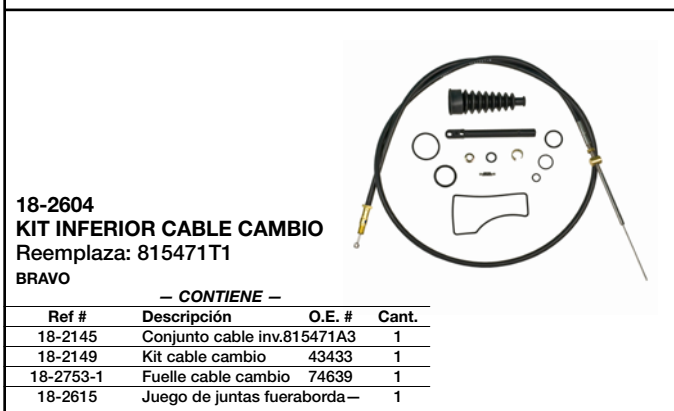

18-2604
KIT INFERIOR CABLE CAMBIO
Reemplaza: 815471T1
BRAVO

- CONTIENE -

Ref #	Descripción	O.E. #	Cant.
18-2145	Conjunto cable inv.815471A3	815471A3	1
18-2149	Kit cable cambio	43433	1
18-2753-1	Fuelle cable cambio	74639	1
18-2615	Juego de juntas fueraborda	-	1



18-2604E
KIT INFERIOR CABLE CAMBIO (EXTREME)
Reemplaza: 815471T1
Usar cable cambio 18-2145E.
Para: Bravo

ABRAZADERAS ACERO INOXIDABLE AISI316



Fabricados con acero inoxidable AISI316.
Para aplicaciones en manguera de 3/16" a 7".

ABRAZADERAS ACERO INOXIDABLE

Ref #	O.E. #	Diámetro	Std. #
18-710-06-2	-	7/16" a 3/4"	006
118-710-10-2	-	9/16" a 1 1/16"	010
18-710-12-2	-	9/16" a 1 1/4"	012
18-710-16-2	-	1 1/16" a 1 1/2"	016
118-710-20-2	-	3/4" a 1 3/4"	020
118-710-24-2	-	1 1/16" a 2"	024

Ref #	O.E. #	Diámetro	Std. #
118-710-32-2	-	1 9/16" a 2 1/2"	032
118-710-48-2	54-815504348	2 9/16" a 3 1/2"	048
18-710-64-2	-	2 1/2" a 4 1/2"	064
18-710-72-2	3	3" a 5"	072
118-710-104-2	-	5" a 7"	104

① Para usar con fuelle 3" ② O.E. #54-32533 ③ O.E. #s 54-31765, 54-815504372



18-2175
ACOPLADOR DEL MOTOR
Reemplaza: 12632A2, 12632A4, 18643A7
Usar eje horquilla 18-2146
Platina flexible para últimos modelos.



18-2195
ACOPLADOR MOTOR
Reemplaza: 12632A3, 12632A7
Usar con eje horquilla 18-2146
Platina flexible para modelos GM 4 cil.

① Precio por pack



18-2323
ACOPLADOR MOTOR
Reemplaza: 18643A5
(Igual que 18-2175 sin horquilla)



18-2321
ACOPLADOR MOTOR
Reemplaza: 12632A6
(Igual que 18-2195 sin horquilla)
Para: Último modelo cilindro GM 4



18-21751
ACOPLADOR MOTOR
Reemplaza: 12632A4, 18643A2, 18643A7



18-2412
ACOPLADOR MOTOR
Reemplaza: 18309A2, 18311A2,
18311A17, 812964A2, 861523A9,
8M0098795
Para: Bravo



18-2413
ACOPLADOR MOTOR
Reemplaza: 69354A1, 69354A2
Para: 470, 485 (224 cu. in.)
S/N 4208730-6218036 (1976-1982)



18-2414
ACOPLADOR MOTOR
Reemplaza: 97432A2
Para: 165, 170, 470, 3.7L S/N 6170297 & SUP (1983-1989)
180, 190, 488, 3.7LX S/N 6170297 & SUP (1983-1989)



18-2171
ACOPLADOR MOTOR
Reemplaza: 32492A2, 32492A3, 32492A5,
38965A1, 38965A2, 76850A2
Para todos los motores GM excepto MR/ALPHA/BRAVO
con "Triangular", 3-acoplador tornillo



18-2172
ACOPLADOR MOTOR
Reemplaza: 14505A2
Usados cuando reemplazas retén V6 o V8 2 piezas
traseras con tornillos de 3-1/2" por un retén trasero
de 1 pieza con tornillo.



18-2173
ACOPLAMIENTO MOTOR
Reemplaza: 59826A1, 59826A3
Para motores Ford

APLICACIONES ACOPLADOR MOTOR

HP	Litro	Modelo	CID	# Cil	tiempo	Año	Serie #	Ref #	HP	Litro	Modelo	CID	# Cil	tiempo	Años	Serie #	Ref #	
110		110	153	4		1963-1966	1537370 - 2044033	18-2171			190	283	V-8	4	1963-1964	1564539 - 1730903	18-2171	
120		120	153	4		1964-1982	1537370 - 6229717	18-2171	5.0L	200	305	V-8	4	1985-1986	6899058 - B525981	18-2171	⊕	
120		120	153	4	4	1964-1982	1666601 - 6229717	18-2171	5.0L	200	305	V-8	4	1985-1986	6899058 - B525981	18-2175	⊕	
120		120	153	4	4	1983-1986	6229718 - B531853	18-2171	⊕	5.0L	200	305	V-8	4	1985-1987	6899058 - B774444	18-2175	
120		120	153	4	4	1983-1986	6229718 - B531853	18-2195	⊕	5.0L	228	305	V-8	4	1977-1982	4765100 - 6218461	18-2171	
	2.5L	2.5L	153	4	4	1987-1989	B531854 - C853255	18-2171	⊕	5.0L	228	305	V-8	4	1977-1984	6218462 - 6899268	18-2171	
	2.5L	2.5L	153	4	4	1987-1989	B531854 - C853256	18-2195	⊕	5.0L	230	305	V-8	4	1985-1987	6899269 - B773739	18-2171	⊕
140		140	181	4	4	1968-1982	2508261 - 6229717	18-2171		5.0L	230	305	V-8	4	1985-1987	6899269 - B773739	18-2175	⊕
140		140	181	4	4	1983-1986	6229718 - B450800	18-2171	⊕	5.0L	5.0L ALPHA	305	V-8	4	1988-1993	B774445 - F000000	18-2175	
140		140	181	4	4	1983-1986	6229718 - B450800	18-2195	⊕	5.0L	5.0L ALPHA	305	V-8	4	1994-1995	F000001 - F600999	18-2323	
140		140 INLINE 6		6	4	1963	1538930 - 1725960	18-2171		5.0L	5.0L GEN+ ALPHA	305	V-8	4	1998-2010	L015751 & SUP	18-2323	
	3.0L	3.0L	181	4	4	1987-1989	B450801 - C856558	18-2171	⊕	5.0L	5.0L GEN + BRAVO	305	V-8	4	1998-2010	L015751 & SUP	18-2412	⊕
	3.0L	3.0L	181	4	4	1987-1989	B450801 - C856558	18-2195	⊕	5.0L	5.0L EFI ALPHA	305	V-8	4	1998-2001	L012052 - M299999	18-2323	
	3.0L	3.0L	181	4	4	1990-1994	C856559 - F603999	18-2195		5.0L	5.0L EFI BRAVO	305	V-8	4	1998-2001	L015751 - M299999	18-2412	
	3.0L	3.0L	181	4	4	1998-2010	L097000 & SUP	18-2323		5.0L	5.0LX ALPHA	305	V-8	4	1988-1993	B773740-F000000	18-2175	
	3.0L	3.0L MPI	181	4	4	2008-2010	A072812 & SUP	18-2323		5.0L	5.0LX ALPHA	305	V-8	4	1994-2007	F000001 & SUP	18-2323	
	3.0L	3.0LX	181	4	4	1990-1993	C856559 - F000000	18-2195		5.0L	5.0L MPI BRAVO	305	V-8	4	1998-2007	L015751 & SUP	18-2412	
	3.0L	3.0LX	181	4	4	1994-1998	F000001 - L096999	18-2321		5.0L	5.0L MPI ALPHA	305	V-8	4	2002-2010	M300000 & SUP	18-2323	
150		150		4		1964-1966	1666495 - 2048046	18-2171		5.0L	5.0L MPI BRAVO	305	V-8	4	2002-2010	M300000 & SUP	18-2412	⊕
160		160		4		1967-1969	2048022 - 2770031	18-2171		5.0L	5.0LX ALPHA	305	V-8	4	1988-1993	B773740 - F000000	18-2175	⊕
165		165	224	4	4	1987	B434941 - B774251	18-2414		5.0L	5.0LX ALPHA	305	V-8	4	1994-1995	F000001 - F600999	18-2323	
165		165 INLINE 6		6	4	1970-1981	2770032 - 5813433	18-2171		5.0L	898	305	V-8	4	1977-1985	4762210 - 6899057	18-2171	
170		170	224	4	4	1985-1986	6916779 - B434940	18-2414			225 (GM)	327	V-8	4	1963-1969	1539820 - 2694014	18-2171	
180		180	224	4	4	1987	B436391 - B775248	18-2414			250	327	V-8	4	1977	4768000 - 4908849	18-2171	
190		190	224	4	4	1985-1987	6916779 - B775248	18-2414		5.7L	260	350	V-8	4	1978-1982	4908850 - 6218461	18-2171	
	3.7L	3.7L	224	4	4	1988-1989	B774252 & SUP	18-2414		5.7L	260	350	V-8	4	1982-1986	6218462 - B525981	18-2171	⊕
	3.7L	3.7LX	224	4	4	1983-1989	B775249 & SUP	18-2414		5.7L	260	350	V-8	4	1982-1987	6218462 - B773304	18-2175	⊕
		470	224	4	4	1976-1982	4208730 - 6218036	18-2413		5.7L	260	350	V-8	4	1987	B525982 - B773304	18-2175	
		470	224	4	4	1983-1984	6218037 - 6916779	18-2414		5.7L	300 TEMPEST ALPHA	350	V-8	4	1985-1986	6668677 - B430367	18-2171	
		485	224	4	4	1980-1982	5685394 - 6218036	18-2413		5.7L	300 TEMPEST ALPHA	350	V-8	4	1986	A434310 - B430367	18-2175	⊕
		488	224	4	4	1983-1984	6170297 - 6916779	18-2414		5.7L	320 EFI	350	V-8	4	1987-1989	A543604 - C622418	18-2175	
		140	194	6	4	1963	1538930 - 1664117	18-2171		5.7L	350 MAG ALPHA	350	V-8	4	1986-1993	A635178 - F000000	18-2175	
		150	230	6	4	1964-1966	1664118 - 2048046	18-2171		5.7L	350 MAG ALPHA	350	V-8	4	1993-1997	F000001 - K999999	18-2323	
		160	250	6	4	1967-1969	2048022 - 2770031	18-2171		5.7L	350 MAG ALPHA EFI GEN +	350	V-8	4	1996-1997	F800300 - K999999	18-2323	
		165	250	6	4	1970-1981	2770032 - 5813433	18-2171		5.7L	350 Mag MPI ALPHA	350	V-8	4	1998-2010	L010019 & SUP	18-2323	
		175	165	4	4	1987	B527955 - B773242	18-2175		5.7L	350 MAG MPI BRAVO	350	V-8	4	1998-2010	L010019 & SUP	18-2412	⊕
185		185 (4bb)	229	6	4	1983-1984	6330183 - 6919655	18-2171		5.7L	350 MAG MPI HORIZON ALPHA	350	V-8	4	2002-2007	M300000 - A299999	18-2323	
175		175	262	V-6	4	1987	B527955 - B773242	18-2175		5.7L	350 MAG MPI HORIZON BRAVO	350	V-8	4	2002-2007	M300000 - A299999	18-2412	⊕
185		185 (2bb)	262	6	4	1985-1986	A331455 - B527954	18-2171	⊕	5.7L	350 MAG MPI HORIZON ALPHA	350	V-8	4	1993-2007	F000001 & SUP	18-2323	
185		185 (2bb)	262	6	4	1985-1986	A331455 - B527954	18-2175		5.7L	HORIZON BRAVO	350	V-8	4	1999-2007	M300000 & SUP	18-2412	
205		205	262	6	4	1985-1986	A331455 - B527954	21-2171	⊕	5.7L	5.7L ALPHA	350	V-8	4	1988-1993	B773305-F000000	18-2175	
205		205	262	6	4	1985-1986	A331455 - B527954	18-2175	⊕	5.7L	5.7L ALPHA	350	V-8	4	1993-2010	F000001 & SUP	18-2323	
205		205	262	6	4	1987	B527955 - B775129	18-2175		5.7L	5.7L BRAVO	350	V-8	4	1988-2010	B773305 & SUP	18-2412	⊕
		262 MAG EFI GEN+	262	V-6	4	1996-1997	F803800 - K999999	18-2323		5.7L	5.7L EFI ALPHA	350	V-8	4	1995-2001	F225560 - M299999	18-2323	
4.3L		4.3L	262	V-6	4	1988-1993	B527955 - F000877	18-2175		5.7L	5.7L EFI BRAVO	350	V-8	4	1998-2001	L010035 - M299999	18-2412	⊕
4.3L		4.3L	262	V-6	4	1993-2010	F000878 & SUP	18-2323		5.7L	5.7LX EFI ALPHA	350	V-8	4	1996-1997	F752400 - K999999	18-2323	
4.3L		4.3L EFI GEN +	262	V-6	4	1998-2001	L012009 - M299999	18-2323		5.7L	5.7LX EFI ALPHA	350	V-8	4	1993-2007	F000001 & SUP	18-2323	
4.3L		4.3L MPI	262	V-6	4	2002-2010	M300000 & SUP	18-2323		5.7L	5.7L EFI BRAVO	350	V-8	4	1998-2007	L010035 & SUP	18-2412	⊕
4.3L		4.3LX GEN +	262	V-6	4	1998-2002	L010044 - M614999	18-2323		5.7L	233	351	V-8	4	1975-1977	4173000 - 4902304	18-2173	
4.3L		4.3LX	262	V-6	4	1988-1993	B775130 - F001219	18-2175		6.2L	377 MAG	377	V-8	4	2008-2010	A300000 & SUP	18-2412	⊕
4.3L		4.3LX (4bb)	262	V-6	4	1993-1995	F001220 - F802999	18-2323		6.2L	MX 6.2L MPI	377	V-8	4	2000-2007	L680003 - A299999	18-2412	⊕
4.3L		4.3LX GEN + (2bb)	262	V-6	4	1996-1997	F803000 - K999999	18-2323		6.2L	MX 6.2L MPI	377	V-8	4	2000-2007	L680003 - A299999	N/D	⊕
4.3L		4.3LX GEN +	262	V-6	4	1996-1997	F803000 - K999999	18-2323		6.2L	MX 6.2L MPI HORIZON	377	V-8	4	2002-2007	M300000 - A299999	18-2412	⊕
5.0L		225 (FORD)	302	V-8	4	1973-1974	3385721 - 4166999	18-2173	⊕									
5.0L		888	302	V-8	4	1971-1977	3108723 - 4887829	18-2173		7.4L	454 MAG ALPHA	454	V-8	4	1986-1988	A631894 - B785148	18-2175	⊕

- ⊕ Usar con transmisión Borg Warner
- ⊗ Baja velocidad / aplicación de trabajo
- ⊕ Montaje doble al volante
- ⊕ Usar con transmisión Hurth
- ⊗ Sólo cambio hidráulico
- ⊗ Sólo I
- ⊕ Acople redondo
- ⊕ Aplicaciones standard Bravo
- ⊕ Montaje acoplador a cigüeñal
- ⊗ Adaptador Triangular
- ⊕ Usar con transmisión Borg Warner 71/72 en línea
- ⊕ Usar con transmisión Borg Warner 5000 o Hurth 630



18-4442
HERRAMIENTA ALINEACIÓN
 Reemplaza: 91-57797A3, 91-57797A2, 91-57797A1, 91-8M0067546, 91-805475A1, 91-48347, 91-37384
 Para usar con todos #1 unidades, MR, todas unidades Alpha & Bravo



18-9803
LLAVE PARA COJINETES
 Reemplaza: 91-36235

Grasa Marina

18-9240-0
 (8 oz Tube)
 Reemplaza:
 Mercury 92-802859A1

18-9240-1
 (14oz Cartridge)
 Reemplaza:
 Mercury 92-802863A1

- Evita la corrosión y óxido
- Evita el desgaste contra la más extrema fricción en aplicaciones marinas.
- No se romperá en condiciones marítimas.
- Contiene PTFE para un mínimo desgaste y fricción añadido protección.
- Para usar en ejes de apoyo, cojinetes de remolque, cables de acelerador y cambio y varillaje, pasadores giratorios y más.



18-2200
KIT ENGRANAJES
 Reemplaza: 43-61027, 43-96084A4
 888 S/N 3106717 & SUP #1 Unidades S/N 3469428 & SUP Excepto, MR/ALPHA Unidades (Sin pie en el eje de dirección).



18-2410
JUEGO ENGRANAJES MARCHA ADELANTE
 Reemplaza: 43-96084A7, 43-96084A5
 Para: transmisiones "R"

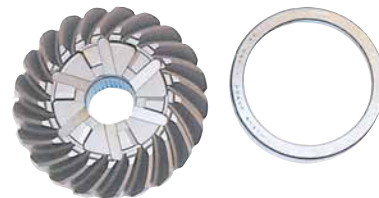

18-2360
PIÑÓN Y JUEGO ENGRANAJES MARCHA ADELANTE
 Reemplaza: 43-828072A3, 43-878087A2
 dientes 13-21



18-2206-1
KIT ENGRANAJES PARTE INFERIOR
 Reemplaza: 43-878087A2 + 43-828073A1, 43-828072A2
 Para: Todos MR/ALPHA/Gen II
 (Excepto Gen II 2.00-2.40 ratios)



18-2409
ENGRANAJES MARCHA ATRAS
 Reemplaza: 43-92320, 43-92320T
 Para: transmisiones "R" (dientes 28)



18-2406
JUEGO DE ENGRANAJES MARCHA ADELANTE
 Reemplaza: 43-878087A2, 43-878072A3
 Para: MR/Alpha/Gen II inf S/N D469859 & SUP



18-2408
ENGRANAJES MARCHA ATRAS
 Reemplaza: 43-828073A1
 Para: Alpha I/Gen II inferior S/N D469859 & SUP

18-2404
KIT REPARACIÓN ENGRANAJES
 Reemplaza: 43-803079T1
 Para: Transmisión "R"



— CONTIENE —

Ref #	Descripción	O.E. #	Cant.
18-2200	Kit parte inferior	43-96084A4	1
18-2202	Desplazable embrague	52-66063	1
18-1157	Cojinete	31-30895	1
18-1155	Cojinete	30-88957A1	1
18-1159	Cojinete	31-35928A1	1
18-2285	Gruesa	15-47397A1	1
18-3719	Tuerca	11-35921	1
18-2299	Arandela	14-79447	1

18-2405
KIT REPARACIÓN ENGRANAJES
 Reemplaza: 43-803091T1
 Para: MR/Alpha I



— CONTIENE —

Ref #	Descripción	O.E. #	Cant.
18-2652	Kit retenes	26-33144A2	1
18-3719	Tuerca	11-35921	1
18-2343	Arandela	12-982721	1
18-2298	Arandela	14-18323	1
18-2299	Arandela	14-79447	1
18-2206-1	Juego engranajes	43-42934	1
18-2285	Grueso	15-47397A1	1
18-1155	Cojinete	30-88957A1	1
18-1158	Cojinete	31-30956	1
18-1117	Cojinete	31-42647A1	1
18-1143	Cojinete Alpha	31-36387A1	1
18-2294	Kit gruesos	15-42637A-1	1
18-2202	Desplazable embrague	52-66063	1



18-2368
KIT CARCASA INFERIOR
 Reemplaza: 43-803071T1
 ALPHA/GEN II 1996-97



18-2369
KIT CARCASA INFERIOR
 Reemplaza: 43-803069T1
 ALPHA/GENII 1991-95

18-2407
KIT ENGRANAJES
 Reemplaza:
 43-878087A4, 43-823072A2, 43-42933A3,
 43-42933A2, 43-17064A3
 Para: MR/Alpha/Gen II
 Alojamiento engranaje inf



— CONTIENE —

Ref #	Descripción	O.E. #	Cant.
18-2206-1	Juego engranajes	43-42934	1
18-1155	Cojinete	30-88957A1	1
18-1117	Cojinete	31-42647A1	1
18-1158	Cojinete	31-30956	1
18-1143	Cojinete Alpha	31-36387A1	1
18-2294	Grueso Kit	15-42637A-1	1
18-2285	Grueso	15-47397	1
18-3719	Tuerca	11-35921	1
18-2343	Arandela	12-982721	1



18-2202
EMBRAGUE DESLIZANTE
 Reemplaza:
 52-66063,
 52-853594T,
 52-853594, 52-824112
 888 S/N 3784375 & SUP
 #1 Unid. S/N 3469428 & SUP



18-2357
PASADOR
 Reemplaza:
 17-30632,
 17-8M0030941,
 17-8M0084681

Pack. de 2

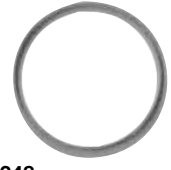

18-2348
18-2348-9①
MUELLE TRINQUETE
 Reemplaza: 24-30893
 1/MC-1/R/MR/Alpha
 Mercuriser/Gen II inferior
 S/N D469859-F679999
 Mercuriser Vazer



18-2166
EJE TRANSMISIÓN
 Reemplaza: 44-66060, 44-660603, 44-824110, 44-660602, 44-55857
 Para todos #1 & MR/ALPHA Unidades S/N 2791957 & ant.
 Also for 165 (6 cil.) S/N 2763442 & ant.

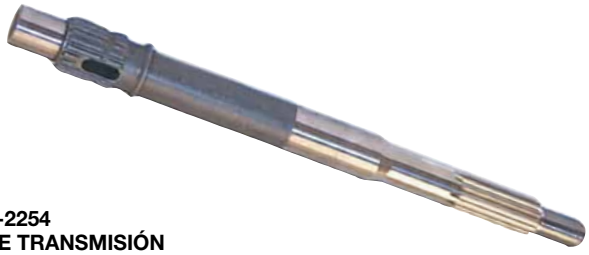

18-2254
EJE TRANSMISIÓN
 Reemplaza: 44-850308
 Para: Alpha One Gen II S/N 0L100040 & sup/Vazer

① Precio por pack



18-2180
EJE TRANSMISIÓN
 Reemplaza: 45-42634
 Para todos MR/ALPHA Unidades que hayan sido re-equipadas con unidades inferiores MR/ALPHA.



18-2331
EJE TRANSMISIÓN
 Reemplaza: 45-853648, 45-853647
 Para: Ratios 1.47, 1.62, 1.81 & 1.94.
 Para: Gen II (1998 & sup), (0L100040 & sup)
 Para usar con: 18-2400 parte inferior



18-2261
EJE TRANSMISIÓN
 Reemplaza: 45-816919
 Todos Alpha I Generación II (con impulsor de modelo nuevo 18-3056)
 Serie #D494569 & superiores.



18-2346
COJINETE
 Reemplaza: 824519, 8245191, 11-42633, F694961, F694961-1
 Para: MR Alpha & Gen II



18-3719
TUERCA PIÑÓN
 Reemplaza: 11-35921, 11-47411, 11-826375, 11-F694188
 5/8" - 18 dientes • Llave 1 1/16"



18-2359
JUEGO TUERCAS EJE TRANSMISIÓN
 – INCLUYE –

Sierra #	Descripción	Reemplaza:
18-3719	Tuerca	11-35921
18-2343	Arandela de tuerca piñón	12-92721



18-2286
 Reemplaza: 66067, 66067T, 19755A2, 808349A1, 808349T1

18-2196
 Reemplaza: 37967, 61073, 19755A4, 19755A08

CARRETE

APLICACIÓN CARRETE

Modelo	Serie #	Ref #
1A (EZ-Shift)	1776349 & SUP	18-2196
1B (EZ-Shift)	1775193 & SUP	18-2196
1C (EZ-Shift)	1777799 & SUP	18-2196
120/140	2062141-3780849	18-2196
120/140	3780850 & SUP	18-2286
160	2065190-2763441	18-2196
165	2763442-3780849	18-2196
165	3780850 & SUP	18-2286
888	3106717-3784374	18-2196
888	3784375 & SUP	18-2286
898/228	4782330 & SUP	18-2286
225-S	3856268-4200499	18-2286
233	4200500 & SUP	18-2286
470/485	4208730 & SUP	18-2286
R/MR/Alpha One	6225377 & SUP	18-2286
Alpha One (Gen II)	D494569 & SUP	18-2286



18-3759
ARANDELA EMPUJE
 Reemplaza: 35915



18-2342
ARANDELA
 Reemplaza: 68100, 681001
 Para: MR/ALPHA



18-2191
COJINETE DIABOLO
 Reemplaza: 56211A1, 73020A1, 73020A14
 Para: #1R/MR/Alpha I
 Para: Alojamiento con n° de serie #73020C



18-2376
COJINETE DIABOLO
 Reemplaza: 73020A20, 818763A4,
 818763A10
 Para: Alpha Gen II & MR Unidades
 Para: alojamiento con n° de serie #73020C1, Mer-
 cruiser Vazer



18-2150
EJE CAMBIO
 Reemplaza: 37973, 65028, 66066, 77481,
 774811
 Acero inoxidable



18-2353
ALOJAMIENTO COJINETE
 Reemplaza: 23-815921A21, 23-
 815921A17, 23-815921A10, 23-815921A8,
 23-815921A6, 815921A2



18-2154
CASQUILLO
 Reemplaza: 23-30617A1, 23-30617A2
 Mercruiser & Alpha 1 (S/N 1684188 & SUP)



18-3198
REJILLA TOMA DE AGUA
 Babor
 Reemplaza: 93424, 934241, 934243
 Para: MR Alpha



18-3199
REJILLA TOMA DE AGUA
 Estribor
 Reemplaza: 93423, 934231, 934233
 Para: MR Alpha



18-2320
EJE CAMBIO
 Reemplaza: 815919A1
 Para: Gen II



18-2130
LEVA CAMBIO
 Reemplaza: 66062,
 76865, 8M2009865
 Para todos #1 Units R/MR/Alpha,
 Mercruiser Vazer

Pack. de 2



18-4295
18-4295-9^①
CLIP
 Reemplaza: 53-29641
 Para: Gen II



18-2299
ARANDELA CIERRE
 Reemplaza: 14-79447,
 14-52833



18-2298
ARANDELA CIERRE
 Reemplaza: 14-
 18323, 14-17460



18-3751
TUERCA
 Reemplaza: 79448
 Para: Mercruiser Vazer



18-2354
CIERRE RETÉN
 Reemplaza: 821759A4, 821759A3,
 821759A2, 821759A1, 815922A5,
 815922A1, 807929A2, 807929A1

Pack. de 2



18-2707
18-2707-9^①
COLLAR CIERRE
 Reemplaza: 97351
 Para: Bravo



18-1117
COJINETE PIÑÓN
 Reemplaza: 31-42647A1



18-1356
COJINETE PIÑÓN
 Reemplaza: 31-54928

Modelo	Año	Modelo	Año
215 E/H	1970-72	II, TR	1973-76
225TRS, 280 TRS	1973-76	TR, TRS	1977-93



18-1142
COJINETE PIÑÓN SUPERIOR
 Reemplaza: 31-32573A1



18-1193
COJINETE RODILLOS
 Reemplaza: 31-33138A1
 Para: Gen II (1998-Sup), Mercruiser Vazer



18-1143
COJINETE RODILLOS
 Reemplaza: 31-36387A1



18-1156
COJINETE RODILLOS AVANCE
 Reemplaza: 31-30894A1
 Para: Mercruiser Vazer



18-1161
COJINETE RODILLOS
 Reemplaza: 31-35990A1
 Para: Mercruiser Vazer



18-1162
COJINETE RODILLOS
 Reemplaza: 31-38356A1, 31-F84901, FA84901, F84903



18-1164
COJINETE RODILLOS
 Reemplaza: 31-53079A1, 31-53079



18-1165
COJINETE RODILLOS
 Reemplaza: 31-61100A1



18-1173
COJINETE RODILLOS
 Reemplaza: 31-828437A2



18-1179
COJINETE RODILLOS
 Reemplaza: 31-32575A1, T1
 Para: Gen II F680000 & SUP,
 Mercruiser Vazer



18-1127
COJINETE RODILLOS
 Reemplaza: 31-54038A1
 Para: Bravo II - inferior (S/N B664190 & SUP)



18-1182
KIT COJINETE RODILLO
 Reemplaza: 31-30894A5
 Para: Alpha I (Gen II) (1998 & sup) (OL100040 & sup), Mercruiser Vazer



18-1197
COJINETE
 Reemplaza: 31-828439A2
 Para: Alpha I (Gen II) (1996-97) (OF680000-OK999999)



18-1129
COJINETE EJE TRANSMISIÓN SUPERIOR
 Reemplaza: 31-86748A1, 31-8M0103473, 31-F506818, F508814
 Para: Bravo I, II, III - inferior (S/N B664190 & SUP)



18-1150
COJINETE RODILLO
 Reemplaza: 31-92366A1, 31-92366



18-1157
COJINETE AGUJA
 Reemplaza: 31-30895, 31-30895T
 Para: Mercruiser Vazer



18-1158
COJINETE AGUJA
 Reemplaza: 31-30956, 31-30956T, 31-F523058
 Para: Mercruiser Vazer



18-1153
COJINETE A BOLAS
 Reemplaza: 30-63326, 30-63326T, 30-49313, 30-54215, 30-20464



18-1155

COJINETE A BOLAS

Reemplaza: 30-88957A1, 30-88957T, 30-35914, 30-17927, 30-89957



18-1160

KIT COJINETES

Reemplaza: 31-35988A2, 31-35988A12

COJINETES PARA ENGRANAJES SUPERIORES DE COLAS MERCUISER

Modelo colas	Relación	Año	Nº de serie	Cojinete Transom	Cojinete Bolas	Tapa superior
IA,IB,IC & EZ Shift	Todos	1964-66	1684188 - 2065186	18-1160	18-1161	18-1179
120/140	1.98	1967	2062141 - 2187468	18-1160	18-1161	18-1161
120/140	1.98	1967-71	2187469 - 3134193	18-1160	18-1161	18-1179
120/140	1.98	1971-82	3134194 - 6225576	18-1160	18-1161	18-1165
470/485	1.84	1976-82	4208730 - 6225576	18-1160	18-1161	18-1165
160	1.68	1967	2065190 - 2182197	18-1160	18-1161	18-1161
160	1.68	1967-71	2182198 - 3134193	18-1160	18-1161	18-1179
165	1.65	1971-81	3213658 - SUP	18-1160	18-1161	18-1165
888	1.5	1971-73	3106717 - 3134193	18-1160	18-1161	—
888	1.5	1973-77	3134194 - SUP	18-1160	18-1161	18-1165
225-S	1.5	1974	3856268 - 4200499	18-1160	18-1161	18-1165
898/228	1.65	1977-82	4782330 - 6225576	18-1160	18-1161	18-1165
233	1.32	1975-77	4200500 - SUP	—	—	18-1165
250	1.32	1977	4791300 - 4898729	—	—	18-1165
255-TRS	Todos	1973-74	3377316 - 4203749	18-1162 ③	18-1162	—
260	1.5	1978-82	4898730 - 6225576	18-1160	18-1161	18-1165
280-TRS	Todos	1975-76	4203750 - 4895399	18-1162 ③	18-1162	—
R/MR/Alpha One	1.98/1.84/ 1.65/1.50	1984-90	6225577 - SUP	18-1160	18-1161 ① ④	18-1165
R/MR/Alpha One	1.5	1984-90	6225577 - SUP	18-1160	18-1142	18-1165
R/MR/Alpha One	1.32	1984-90	6225577 - SUP	—	—	18-1165
R/MR/Alpha One	1.5 Heavy Duty	1984-90	6225577 - SUP	—	18-1142	18-1165
Alpha One SS	1.32	1986-89	A545004 - SUP	—	—	18-1165
Alpha One SS	1.5	1986-89	A545004 - SUP	—	18-1142	18-1165
Alpha One Gen II	2.40/1.98/ 1.84/1.65	1991-95	D469859 - F679999	18-1160	18-1161 ④	18-1165
Alpha One Gen II	1.5	1991-95	D469859 - F679999	18-1160	18-1142	18-1165
Alpha One Gen II	2.40/1.94/ 1.81/1.62	1996-97	F680000 - K999999	18-1160	18-1161 ④	18-1179
Alpha One Gen II	1.47	1996-97	F680000 - K999999	18-1160	18-1142	18-1179
Alpha One Gen II	2.40/2.00/ 1.94/1.81/ 1.62	1998 & sup	L100040 - SUP	—	18-1161	18-1179
Alpha One Gen II	1.47	1998 & sup	L100040 - SUP	—	18-1142	18-1179
II-TR	—	1973-76	3377316 - 4794899	18-1162 ②	18-1162	—
SSM II	—	1982-97	TODOS	18-1162 ③	18-1162	—
TR/TRS	—	1977-93	4794900 - SUP	18-1162 ③	18-1162	—
Bravo I, II, III	TODOS	—	B664190 & SUP	—	—	18-1129

① Con # 89449 / Cup 89410

② Sólo engranajes rectos

③ Cojinete para horquilla cardan

④ Usar 18-1142 para 1.5:1 relación

COJINETES PARA ENGRANAJES INFERIORES DE COLAS MERCURUISER

Modelo cola	Año	Desde. S/N - hasta. S/N	Rodamiento Eje hélice	Rodamiento eje vertical (Piñón)	Eje transmisión superior	Rodamiento interior piñón adelante	Rod. exterior piñón adelante	Rod. piñón marcha atrás
60	1965-66	1830753 - 2063740	—	—	—	—	18-1162	—
80/90	1966-72	2063741 - 3225967	18-1158	—	—	18-1157	18-1156	—
I	1963	1534570 - 1536617	18-1158	—	18-1153	18-1157	18-1156	—
I	1963	1536618 - 1684187	18-1158	—	—	18-1157	18-1156	—
IA,IB,IC & EZ Shift	1964-66	1684188 - 2065189	18-1158	—	—	18-1157	18-1159	18-1155
120/140	1967-69	2062141 - 2791956	18-1158	—	18-1164 ④	18-1157	18-1159	18-1155
120/140	1970-77	2791957 - 4893634	18-1158	—	18-1164	18-1157	18-1159	18-1155
120/140	1978-82	4893635 - 6225576	18-1158	18-1150	18-1164	18-1157	18-1159	18-1155
470	1976-77	4208730 - 4893934	18-1158	—	18-1164	18-1157	18-1159	18-1155
470/485	1978-82	4893835 - 6225576	18-1158	18-1150	18-1164	18-1157	18-1159	18-1155
160	1967-69	2065190 - 2763441	18-1158	—	18-1164 ④	18-1157	18-1159	18-1155
165	1970-77	2763442 - 4890459	18-1158	—	18-1164	18-1157	18-1159	18-1155
165	1978-81	4890460 - SUP	18-1158	18-1150	18-1164	18-1157	18-1159	18-1155
888	1971-77	3106717 - SUP	18-1158	—	18-1164	18-1157	18-1159	18-1155
225/233	1974-77	3856268 - SUP	18-1158	—	18-1164	18-1157	18-1159	18-1155
898/228	1977	4782330 - 4898729	18-1158	—	18-1164	18-1157	18-1159	18-1155
898/228	1978-82	4898730 - 6225576	18-1158	18-1150	18-1164	18-1157	18-1159	18-1155
250	1977	4791300 - 4898729	18-1158	—	18-1164	18-1157	18-1159	18-1155
255-TRS	1973-74	3377316 - 4203749	18-1158	—	—	—	18-1159	N/D
260	1978-82	4898730 - 6225576	18-1158	18-1150	18-1164	18-1157	18-1159	18-1155
280-TRS	1975-76	4203750 - 4895399	18-1158	—	—	—	18-1159	N/D
R	1983	6225577 - SUP	18-1158	18-1150	18-1164	18-1157	18-1159	18-1155
MR / Alpha One	1984-90	6225577 - SUP	18-1158	18-1117	18-1143	—	18-1159 ⑤	18-1155
MR / Alpha One	1984-90	6225577 - SUP	18-1158	18-1117	18-1143	18-1157 ②	18-1159 ⑤	18-1155
MR / Alpha One (CR)	1984-90	6225577 - SUP	18-1158	18-1117	18-1143	—	—	—
Alpha One SS	1986-89	A545004 - SUP	18-1158	18-1117	18-1143	18-1157	18-1159	18-1155
Alpha One Gen II	1991-95	D469859 - F679999	18-1158	18-1117	18-1143	18-1157	18-1159 ⑤	18-1155
Alpha One Gen II (CR)	1991-95	D469859 - F679999	18-1158	18-1117	18-1143	—	—	—
Alpha One Gen II	1996-97	F680000 - K999999	18-1158	18-1117	18-1143	18-1157	18-1156	18-1155
Alpha One Gen II (CR)	1996-97	F680000 - K999999	18-1158	18-1117	18-1143	—	—	—
Alpha One Gen II	1998-newer	L100040 - SUP	18-1158	18-1117	18-1143	18-1157	18-1156 ③	18-1155
Alpha One Gen II (CR)	1998-newer	L100040 - SUP	18-1158	18-1117	18-1143	—	—	—
II	1962-67	1474909 - 2275488	—	—	—	N/D	18-1156 ③	N/D
II ③	1968-69	2398798 - 2671321	—	—	—	—	18-1162	18-1156
II-TR	1973-76	3377316 - 4794899	—	—	18-1161 ①	—	—	N/D
TR	1973-93	4794900 - SUP	—	—	18-1161 ①	—	—	N/D
TRS	1973-93	4794900 - SUP	18-1158	—	—	—	18-1159	N/D

① 18-1161 Rodamiento superior / 18-1163 Rodamiento eje vertical

② Torrington#B1616
③ Piñón eje hélice

④ #15520 gravado en la tapa

⑤ Usar 18-1173 para 2.40:1 sólo ratio (nuevo modelo piñones parte inferior) 18-2206-1



18-2349
CASQUILLO GOMA
Reemplaza: 23-67370



18-2244
18-22441-9^①
(Pack. de 50 sin junta)
TAPÓN DRENAJE
Reemplaza: 10-79953A2, 10-79953, 10-79953Q04, 10-28634, 10-28634A1, 10-20259, 816610A1, 816610A2, F40109, 10-F50109
Para: #1/R/MR/Alpha/Alpha I Gen II
Para ambas unidades inferior y superior



② 18-2375D
18-2375
18-23751-9^①
(Pack de 50 sin junta)
TAPÓN DRENAJE
Reemplaza: 10-14834, 10-14834A1, 22-67892, 22-67892A1, 22-67892A05, 22-67892A06, 22-8M0058389 (Magnético)
Para: Alpha MR/Gen II unidades inferiores
No para usar en unidades inferiores #1/R



18-2460
KIT TAPONES
Reemplaza: 22-88847A1, 11-88462
Para: Mercruiser



18-72005
KIT TUERCAS Y ARANDELAS
Para: Transmisiones Mercruiser R/MR/Alpha/Gen II



① 18-4220D
18-4220
ARANDELA EMPUJE
Reemplaza: 13171, 77987
V-6, fuerabordas & colas Mercruiser



18-3784
ARANDELA EMPUJE
Reemplaza: 805100
Para: Bravo III (Frontal)



② 18-3701D
18-3701
KIT TUERCAS HÉLICE
Reemplaza: 11-52707A1, 11-52707A2, 11-52707Q1



18-3755
KIT TUERCAS HÉLICE
Para: Bravo III (Frontal)



18-3756
KIT TUERCAS HÉLICE
Para: Bravo III (posterior)

- CONTIENE -

Ref #	O.E. #	Descripción
18-3200	14-31210, 14-816629, 14-816629Q, 14-F697140	Arandela
18-3700	11-52707	Tuerca

Pack de 10



18-3200
18-3200-9^①
ARANDELA
Reemplaza: 14-31210, 14-816629, 14-816629Q, 14-F697140



18-3787
ARANDELA
Reemplaza: 805101T
Para: Bravo III (posterior)

Pack de 10



18-3788-9^①
ARANDELA
Reemplaza: 14-34817
Para: Bravo II



18-72510
KIT TORNILLO
Para: Mercruiser acoplador al volante



18-3783
TUERCA HÉLICE
Reemplaza: 11-859131, 11-805092, 11-805092T, 11-805100T
Para: Bravo III (Frontal)



18-3785
TUERCA HÉLICE
Reemplaza: 11-82671127, 11-54034, 11-39907, 11-39823
Para: Bravo II



18-3786
TUERCA HÉLICE
Reemplaza: 11-862907, 11-805093
Para: Bravo III (posterior)

① Precio por pack

② Referencias acabadas en "D" envasadas - Referencia normal no envasada



18-3700
TUERCA HÉLICE
 Reemplaza: 11-52707,
 11-52707A1, 11-52707Q1,
 11-52707A2, 11-827614,
 F7040
 3/4" - 20 dientes • Llave 1 1/16"



18-3714
ARANDELA DE BRONCE
 Reemplaza: 12-31211A2,
 12-31211, 12-31211A3,
 12-31211Q03
 Para: Alpha/Bravo I (Sin Flo-Torq II Hub)
 NOTA: Para los productos anteriores con
 núcleos de goma (no-Flo-Torq II)



18-4444
HERRAMIENTA TUERCA HÉLICE
 Reemplaza: 91-95830A1, 91-95830, 91-38277A1



18-4459
HERRAMIENTA TUERCA HÉLICE
 Reemplaza: 91-821887A1, 91-859046Q4, 91-859046T4



18-4446
KIT HERRAMIENTA TUERCA HÉLICE

— CONTIENE —

Ref #	O.E. #	Descripción
18-3200	14-31210, 14-816629	Arandela
18-3700	11-52707	Tuerca hélice
18-4444	91-95830A1	herramienta tuerca hélice

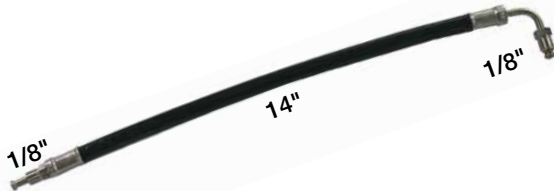

18-2103
LATIGUILLO TRIM
 Reemplaza: 32-47373, 32-66073, 32-68676, 32-73004, 32-79431, 32-86036, 32-86036A1, 32-86036Q

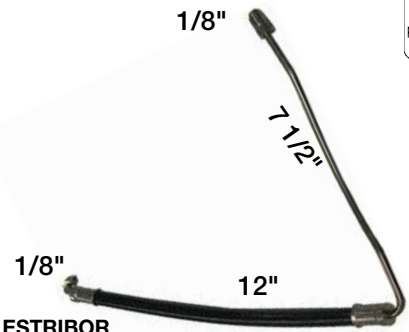

18-2105
LATIGUILLO TRIM ESTRIBOR
 Reemplaza: 32-45973



18-2106
LATIGUILLO TRIM BABOR
 Reemplaza: 32-45974



18-2107
LATIGUILLO TRIM
 Reemplaza: 32-55816



18-2108
LATIGUILLO DE BOMBA A CONECTOR
 Reemplaza: 32-59841, 32-59841A1, 32-73123



18-2109
LATIGUILLO TRIM
 Reemplaza: 32-59842, 32-73005

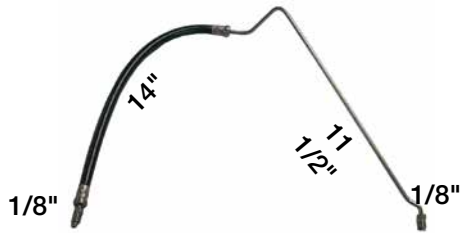

LATIGUILLO TRIM

Estribor
Conector al cilindro de trim inferior MCM 120-260 & BRAVO

Ref #	O.E. #	Descripción
18-2114	32-99902-1, 32-864960	Trim Cil. Casting #14034-1
18-2136*	32-99902, 32-864589	Trim Cil. Casting #98704, 98704-1

* Aproximadamente 11 1/4" largo

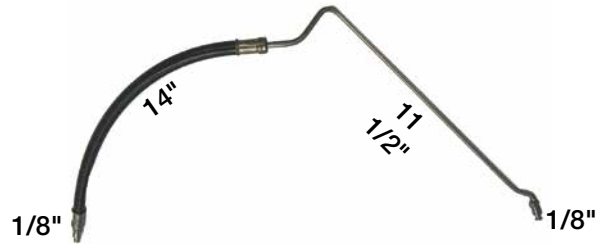

LATIGUILLO TRIM

Babor
Conector al cilindro de trim inferior MCM 120-260 & BRAVO

Ref #	O.E. #	Descripción
18-2115	32-99903-1, 32-864959	Trim Cil. Casting #14035-1
18-2137*	32-99903, 32-864588	Trim Cil. Casting #98703, 98703-1

* Aproximadamente 11 1/4" largo



18-2112
LATIGUILLO TRIM BABOR
Reemplaza: 32-87234



18-2113
LATIGUILLO TRIM ESTRIBOR
Reemplaza: 32-87235



18-2435
LATIGUILLO POWER TRIM
Reemplaza: 32-861127, 32-95858
Para R/MR/Alpha/Alpha Gen II/Bravo I, II, III/Bravo X, XR, XZ
N° serie 0W099999 y post sin accesorios de conexión rápida
OEM color manguera negro.



18-2436
LATIGUILLO POWER TRIM
Reemplaza: 32-861128, 32-95859
Para R/MR/Alpha/Alpha Gen II/Bravo I, II, III/Bravo X, XR, XZ
N° serie 0W099999 y post sin accesorios de conexión rápida
OEM color manguera gris.

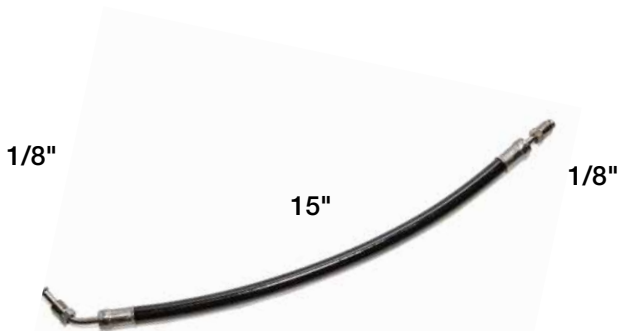

18-2116
LATIGUILLO TRIM
Reemplaza: 32-99904, 32-99904Q

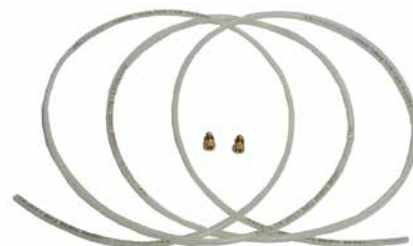

18-2126
LATIGUILLO TRIM
Reemplaza: 32-52951A1, 32-48418

APLICACIÓN MANGUERA POWER TRIM

Modelo Colas	Años	Nº serie	Cilindro de trim a conector (babor inferior)	Cilindro de trim a conector (babor superior)	Cilindro de trim a conector (estribor inferior)	Cilindro de trim a conector (estribor sup)	Bomba a conector hidráulico	Latiguillo bomba hidráulica	Conector a válvula reversa	Bomba hidráulica y válvula reversa
120, 140	1967-69	2062141 - 2791956	—	18-2106	—	18-2105	—	N/D	—	18-2126
120, 140	1970-73	2791957 - 3780849	18-2103	18-2103	18-2103	18-2103	18-2107	N/D	—	18-2126
120, 140	1974-82	4893635 - 6225576	18-2103	18-2103	18-2103	18-2103	18-2107	N/D	18-2109	18-2126
470/485	1976-82	4208730 - 6225576	18-2103	18-2103	18-2103	18-2103	18-2107	N/D	18-2109	18-2126
160	1967-69	2065190 - 2763441	—	18-2106	—	18-2105	—	N/D	—	18-2126
165	1970-73	2763442 - 3780849	18-2103	18-2103	18-2103	18-2103	18-2107	N/D	—	18-2126
165	1974-81	3780850 & SUP	18-2103	18-2103	18-2103	18-2103	18-2107	N/D	18-2109	18-2126
888	1974 & SUP	3106717 & SUP	18-2103	18-2103	18-2103	18-2103	18-2108	N/D	18-2109	—
225/233	1974-77	3856268 & SUP	18-2103	18-2103	18-2103	18-2103	18-2108	N/D	18-2109	—
228/898/250/260	1977-82	4782330 - 6225576	18-2103	18-2103	18-2103	18-2103	18-2108	N/D	18-2109	—
R/MR/Alpha/SS	1983-90	6225577 & SUP	18-2137 ③	18-2116	18-2136 ③	18-2116	18-2436⑤	18-2435⑤	N/D	N/D
R/MR/Alpha/SS	1983-90	6225577 & SUP	18-2115 ④	18-2116	18-2114 ④	18-2116	18-2436⑤	18-2435⑤	N/D	N/D
Alpha One GEN II	1991-97	D469859 & SUP	18-2115	18-2116	18-2114	18-2116	18-2436⑤	18-2435⑤	N/D	N/D
Alpha One GEN II ⑥	1998 & SUP	0L100040 & SUP	18-2115	18-2116	18-2114	18-2435	18-2436⑤	18-2435⑤	N/D	N/D
Bravo I,II & III ⑥	1988 & SUP	B664190 & SUP	18-2137	18-2116	18-2136	18-2116	18-2436⑤	18-2435⑤	N/D	N/D
Blackhawk	1994-95	F186717 & SUP	18-2137	18-2116	18-2136	18-2116	18-2436⑤	18-2435⑤	N/D	N/D
II (1.78)	1968-69	2398798 - 2671321	18-2103	18-2103	18-2103	18-2103	—	N/D	—	18-2126
III	1968-72	2373127 - 3002613	18-2103	18-2103	18-2103	18-2103	—	N/D	—	—
215E/H	1970-72	2909035 - 2915034	18-2103	18-2103	18-2103	18-2103	—	N/D	—	—
TR/TRS	1973-93	3377316 & sup	18-2103 ②	18-2103	18-2103 ②	18-2103	—	N/D	—	—
TR/TRS	1973-93	3377316 & sup	18-2103 ②	18-2103	18-2103 ②	18-2103	—	N/D	—	—
TR/TRS	1973-93	3377316 & sup	— ①	18-2103	— ①	18-2103	—	N/D	—	—

- ① Terminación en 90°
- ② Estriado exterior
- ③ Estriado interior
- ④ Bomba Oildyne
- ⑤ 18-2436 OEM manguera color gris, 18-2435 OEM manguera color negro
- ⑥ N° serie 0W099999 y post sin accesorios de conexión rápida

- ★ Caucho moldeado de alta calidad
- ★ Conector de manguera metálico con arandela de goma
- ★ Utiliza manguera estandar
- ★ Acabado dicromate resistente a la corrosión
- ★ Instalado en segundos
- ★ No necesarias herramientas



**18-9010
TOMA AGUA REFORZADA**

Limpia de sal y sedimentos los conductos del motor. Se fija fácilmente.

TUERCAS AUTOBLOCANTES INOX



Ref #	O.E. #	Rosca	Std. Pack.
18-3720 ③	11-34932	3/8" - 24	1
18-3721 ③	11-34933, 11-95702, 11-82671015, 11-46355, 11-33962, 11-29241, 11-24648, 11-22178, 11-21298	7/16" - 20	6
18-3722 ③	11-35888, 11-20361, 11-8267089	1/4" - 28	5
18-3723 ③	11-45592	5/16" - 24	1



**18-9099
BLOQUEADOR DE COLAS**
Reemplaza: 817019A1, 817019Q2, 817019A2, 879078, 86459A2, 86459A1, 86459, 41155A2, 41155A1, 32657A4, 32657A3
I.D. 3/4" x 11 1/8" longitud
Para todos ALPHA I, ALPHA Generación II, Bravo I, II, III, y Blackhawk



**18-2372
CIERRE CILINDRO TRIM**
Reemplaza: 88035
1.850 Diámetro
Para: R/MR/Alpha



**18-2373
CIERRE CILINDRO TRIM**
Reemplaza: 14698, 14698T, 14698T10 806191T, 8M0110717
1.890 Diámetro
Para: R/MR/Alpha/ Gen II/Bravo (retenes incluidos)

Pack de 2



**18-2465-9④
PAR DE PIVOTES**
Reemplaza: 19-14842, 19-148421
Para: R/MR/Alpha One (1983-90) n° serie. 6225577 y sup
I/II/III (1988-02) N°serie. 6225577

Pack. de 2



**18-2466-9④
PAR DE PIVOTES**
Reemplaza: 19-815951
Para: Alpha One Gen II (1991-02) N° Serial. OD469859 y sup



**18-2461
KIT PASADOR CILINDRO TRIM**
Reemplaza: 17-44166T1
Para: Bravo I/II/III (1988-02) N°Serial. 6225577 y sup



**18-2462
KIT PASADOR CILINDRO TRIM**
Reemplaza: 17-14873A1, 17-85056
Para: R/MR/Alpha One (1983-90) N° Serial. 6225577 y sup

③ Precio por pieza. Para pedir envasada, Añadir -9 a la referencia normal.

④ Precio por pack



18-2463
KIT PASADOR CILINDRO TRIM
 Reemplaza: 17-14872A1, 17-99207
 Para: R/MR/Alpha One (1983-90)
 N° serie. 6225577 y sup (post.)



18-2464
KIT PASADOR FRONTAL Y POSTERIOR
 Reemplaza: 17-815953T1, 56-864641A24,
 56-18541A75, 17-8M0035070
 Para: todos Alpha One Gen II



18-7633
KIT EMISOR TRIM
 Reemplaza: 805320A03, 805320A1,
 96863A15, 88678A5, 88678A4, 63115A12,
 17693A2
 Para: transmisiones MC-I, R, MR, Alpha, Alpha Gen II,
 Bravo



18-2142
CILINDRO POWER TRIM
 Reemplaza: 45706A1, 45706A3, 45706A6,
 45706A8, 45706A12, 45706A14
 Para Todos colas transmisión modelos con líneas
 internas: 120, 140, 160, 165, 888, 898, 228, 225-S, 233,
 250, 260,470 & 485



18-2148
ALOJAMIENTO CILINDRO TRIM
 Reemplaza: 45523, 45706A4, 77442A1,
 77443
 Para Todas colas modelos: 120, 140, 160, 165, 888, 898,
 228, 225-S, 233, 250, 260,470 & 485



18-2420
CILINDRO POWER TRIM
 Reemplaza: 14034A3, 14034A5, 14034F1,
 14034T, 14034T10
 Para: R/MR/ALPHA (Estribor)



18-2421
CILINDRO POWER TRIM
 Reemplaza: 14035A3, 14035A5, 14035F1,
 14035T, 14035T10
 Para: R/MR/ALPHA (babor)



18-2422
CILINDRO POWER TRIM
 Reemplaza: 815935A7, 815935A3
 Para: GEN II (babor) (S/N F680000 - SUP)



18-2423
CILINDRO POWER TRIM
 Reemplaza: 815954A7, 815954A3
 Para: GEN II (estribor)
 (S/N F680000 - SUP)



18-2424
CILINDRO POWER TRIM
 Reemplaza: 98703A11,
 98703A12, 98703A17, 98703A26
 Para: BRAVO (babor)



18-2425
CILINDRO POWER TRIM
 Reemplaza: 98704A11,
 98704A12, 98704A17,
 98704A26, 8M0708280
 Para: BRAVO (Estribor)



18-2426
CILINDRO POWER TRIM
 Reemplaza: 98703A3
 Para: R/MR/ALPHA (babor)



18-2427
CILINDRO POWER TRIM
 Reemplaza: 98704A3
 Para: R/MR/ALPHA (Estribor)



18-2649
KIT RETENES TRIM
 Reemplaza: 25-87400A2



18-2291
KIT AROS TÓRICOS DE TRIM
 Reemplaza: 25-60342A2,
 25-60342A1
 Para todas los modelos de colas: 120,
 140, 160, 165, 888, 898, 228, 225-S, 233,
 250, 260,470 & 485



18-2428
KIT REPARACIÓN CILINDRO TRIM
 Reemplaza: 87399A2, 87399A1
 Para: R/MR/ALPHA I, BRAVO



18-2429
KIT REPARACIÓN CILINDRO TRIM
 Reemplaza: 87399A3
 Para: ALPHA I GEN II

APLICACIÓN CILINDRO POWER TRIM

Modelo	Año	Nº serie	Cilindro trim babor	Cilindro trim Estribor	Alojamiento babor	Alojamiento estribor	Kit retenes cilindro trim
120 / 140 4 cil	1967-1969	2062141-2791956	18-2142	18-2142	N/D	N/D	N/D
120 / 140	1970-1977	2791957-4893634	18-2142	18-2142	N/D	N/D	18-2291
120 / 140	1978-1982	4893635-6225576	18-2142 ④	18-2142 ④	N/D	N/D	18-2291
120 / 140	1978-1982	4893635-6225576	N/D ④	N/D ④	N.L.D	N.L.D	18-2291
160 6 cil	1967-1969	2062141-2791956	18-2142	18-2142	N/D	N/D	N/D
160	1967-1969	2065190-2763441	18-2142	18-2142	N/D	N/D	N/D
165	1970-1977	2763442-4890459	18-2142	18-2142	N/D	N/D	18-2291
165	1978-1981	4890460-4890459	18-2142 ④	18-2142 ④	N/D	N/D	18-2291
225 / 233	1974-1977	3856268 & SUP	18-2142	18-2142	N/D	N/D	18-2291
250	1977	4791300-4898729	18-2142	18-2142	N/D	N/D	18-2291
260	1978-1982	4898730-6225576	18-2142 ④	18-2142 ④	N/D	N/D	18-2291
470 / 485	1976-1977	4208730-4893934	18-2142	18-2142	N/D	N/D	18-2291
470 / 485	1978-1982	4893835-6225575	18-2142 ④	18-2142 ④	N/D	N/D	18-2291
898 / 228	1977	4782330-4898729	18-2142	18-2142	N/D	N/D	18-2291
898 / 228	1978-1982	4898730-6225576	18-2142 ④	18-2142 ④	N/D	N/D	18-2291
Todos # 1 DRIVES ④	1970-1982	2791957-6225576	18-2142	18-2142	18-2148	18-2148	18-2291
R / MR / ALPHA I	1983-1990	6225577-D469858	18-2426 ①	18-2427 ①	N/D ⑤	N/D ⑦	18-2649
R / MR / ALPHA I	1983-1990	6225577-D469858	18-2426 ①	18-2427 ①	N/D ⑥	N/D ⑧	18-2649
R	1983-1990	6225577 & SUP	18-2426 ①	18-2427 ①	N/D	N/D	18-2649
MR	1983-1990	6225577 & SUP	18-2426 ①	18-2427 ①	N/D	N/D	18-2649
ALPHA I	1983-1990	6225577 & SUP	18-2426 ①	18-2427 ①	N/D	N/D	18-2649
ALPHA I SS	1986-1989	A545004 & SUP	18-2426 ①	18-2427 ①	N/D ⑤	N/D ⑦	18-2649
ALPHA I SS	1986-1989	A545004 & SUP	18-2421 ②	18-2420 ②	N/D	N/D	18-2649
ALPHA I SS	1986-1989	A545004 & SUP	18-2422	18-2423	N/D	N/D	18-2649
R	1983-1990	6225577 & SUP	18-2421 ②	18-2420 ②	N/D	N/D	18-2649
MR	1983-1990	6225577 & SUP	18-2421 ②	18-2420 ②	N/D	N/D	18-2649
ALPHA I	1983-1990	6225577 & SUP	18-2421 ②	18-2420 ②	N/D	N/D	18-2649
ALPHA I GEN II	1991-2001	D469859 & SUP	18-2422	18-2433	N/D	N/D	18-2649
BRAVO I	1988-2010	B664190 & SUP	18-2424	18-2425	N/D	N/D	18-2649
BRAVO II	1988 & SUP	B664190 & SUP	18-2424	18-2425	N/D	N/D	18-2649
BRAVO III	1988 & SUP	B664190 & SUP	18-2424	18-2425	N/D	N/D	18-2649
BRAVO SEACORE	2007-2010	W900000 & SUP	N/D	N/D	N/D	N/D	18-2649
BLACKHAWK	1994-1995	F186717 & SUP	18-2424	18-2425	N/D	N/D	18-2649

- | | | |
|--|---|---|
| ① 11 3/8" TUBOS LARGOS - LÍNEAS DEL CILINDRO INTERNO | ② 13 3/4" TUBOS LARGOS - LINEAS TRIM INTERNAS | ③ FUNDICIÓN #14034 1 |
| ④ CASTING 14035 1 | ⑤ CASTING #98703 | ⑥ FUNDICIÓN #98703 1 |
| ⑦ CASTING #98704 | ⑧ CASTING #98704 1 | ⑨ ESTRIAS EXTERNAS TRIM |
| ⑩ ESTRIAS INTERNAS TRIM | ⑪ USAR CON 15 9/16" CILINDRO TUBO LARGO TRIM | ⑫ USAR CON 16 3/16" CILINDRO TUBO LARGO TRIM |
| ⑬ CILINDROS TRIM CON LINEAS DE TRIM INTERNAS | ⑭ CILINDROS TRIM CON LINEAS DE TRIM EXTERNAS | ⑮ EXCLUYE TR, TRS, 215E, H, & ANT. II & III TRANSMISIÓN |

Pack de 5



18-4252
18-4252-9⑦
MUELLE DE CONTINUIDAD
 Reemplaza: 24-46312
 Sujeta el cilindro trim al pivote del eje.



18-2151
 7 1/2" (Frontal)
 Reemplaza: 17-45738

18-2152
 10 1/2" (Trasero)
 Reemplaza: 17-45735

PASADOR PIVOTE
 Usado en 120, 120-260, 140, 165, 225S, 233, 250, 470, 888, 898/228
 Usa casquillo 18-2701



18-2393
PASADOR PIVOTE
 Reemplaza: 17-14872
 Para: Trim cilindro trasero R/MR/Alpha
 Usa: Casquillo 18-2702-1



18-2394
PASADOR PIVOTE
 Reemplaza: 17-14873
 3/8" - 24 rosca
 Para: Trim cilindro frontal R/MR/Alpha
 Usar: casquillo 18-2702-1



18-2395
PASADOR PIVOTE
 Reemplaza: 17-815953A, 17-815953A1
 Para: Trim cilindro frontal & trasero Gen II



18-2396
PASADOR PIVOTE
 9 1/4" longitud • 7 1/2" longitud del eje
 Reemplaza: 17-44166
 Para: Bravo trasero













18-2397
PASADOR PIVOTE
 Reemplaza: 17-44167A1, 17-44167
 Para: Frontal Bravo

- ④ Pack estándar precio por pieza 8
 ⑤ Pack estándar de 8 precio por pack
 ⑥ Precio por pack de 4
 ⑦ Precio por pack

 <p>CASQUILLO POWER TRIM 18-2701^⑤ 18-2701-04^⑥ 18-2701-9^④ Reemplaza: 23-89574, 23-61290, 23-45736 Para unidad transmisión 120/260 (S/N 6225276 & inferiores)</p>	 <p>CASQUILLO POWER TRIM 18-2702-1^⑤ 18-2702-04^⑥ 18-2702-1-9^④ Reemplaza: 23-99291, 23-99291 T Para unidad transmisión 120/260 (S/N 6225277 & SUP)</p>	<p>PACK. DE 8</p>  <p>18-4288 18-4288-9^⑦ CASQUILLO POWER TRIM Reemplaza: 23-807073, 23-44165 Para: Bravo</p>	 <p>18-2345 18-2345-9^⑦ ARO RETENEDOR CILINDRO TRIM Reemplaza: 53-815949 Para: Gen II</p>
<p>Pack. de 2</p>  <p>18-4289 18-4289-9^⑦ ARO RETENEDOR Reemplaza: 53-805272 Para: Bravo</p>	<p>Pack. de 4</p>  <p>18-2336 18-2336-9^⑦ CASQUILLO POWER TRIM Reemplaza: 23-47392, 23-61291, 23-90203 Para: TR & TRS(1977-93), Alpha One SS (1986-1989) , SSM(1982-1995)</p>	<p>Pack. de 8</p>  <p>18-2341-1 18-2341-1-9^⑦ CASQUILLO POWER TRIM Reemplaza: 23-815950, 23-8159501, 23-815950Q01 Para: Gen II</p>	<p>Pack de 5</p>  <p>18-3232 18-3232-9^⑦ TAPÓN Reemplaza: 19-47579, 19-475791 Para: MR Alpha</p>

El zinc es sólo para aplicaciones en agua salada.
El Magnesio es sólo para aplicaciones en agua dulce..
El Aluminio es para ser usado tanto en agua dulce como en agua salada.

 <p>18-6154A 18-6154M 18-6154Z KIT ANODO Bravo III (2004 y nuevos)</p>	 <p>18-6158M 18-6158Z 18-6158A KIT ANODO Reemplaza: 888755Q01 (18-6158M), 888756Q01 (18-6158A), 97-888756Q03 (18-6158A, M), 888756A1 (18-6158A, M) Mercuriser Alpha I Gen II (1991 & SUP)</p>	 <p>18-6159A 18-6159M 18-6159Z KIT ANODO Reemplaza: 888758Q01 (18-6159A), 888757Q01 (18-6159M), 97-888758Q03 (18-6160A), 888758A1 (18-6160A), 97-888759Q03 (18-6160M), 888759A1 (18-6160AM) Mercuriser Bravo I - Todos años</p>	 <p>18-6160A 18-6160M 18-6160Z KIT ANODO Reemplaza: 888761Q01 (18-6160A), 97-888761Q03 (18-6160A), 888761A1 (18-6160A), 888760Q01 (18-6160M), 97-888760Q03 (18-6160M), 888760A1 (18-6160M) Bravo II (1989 & sup), Bravo III (1989-03)</p>
 <p>① 18-6117A ② 18-6117M ③ 18-6117Z ÁNODO Reemplaza: 97-806188A1, 97-806188Q01 Para: Bravo One bearing carrier</p>	 <p>② 18-6241 ③ 009354 ① 18-6011A ÁNODO Reemplaza: 31640, 31640A1, 97-31640Q4, 31640T6, 97-31640B4, 31640A4, 31640A2, 316404, 316403, 72436A1 Para usar en R/MR/Alpha One, colas & Transom Assembly (1983-90) & prior drives, Alpha One, Gen II (1991 & sup)</p>	 <p>③ 009353 ÁNODO Reemplaza: 34127A1, 34127T2, 34127A2, 34127T1, 34127 Para usar en R/MR/Alpha One (colas & Transom Assembly 1983-90) & anteriores</p>	 <p>③ 025300 ÁNODO Reemplaza: 34762A1, 97-34672C, 32170, 32170A1 Para usar en Alpha One SS (Colas & Transom) & anteriores</p>
 <p>③ 025849 ① 18-6014A ÁNODO Reemplaza: 46399A1, 822777A1, 822777Q1, 822777A4, 822777A3, 8227772, 822777, 463999A2</p>	 <p>⑥③ 009321 ③⑤ 18-60151-9 ⑥① 18-6015A-9 ⑥② 18-6242-9 ÁNODO Reemplaza: 55989A3, 55989Q9, 55989T9, 55989A9, 55989A4, 55989 Bravo I, II, III (1988-95)</p>	 <p>③ 009371 ③④ 18-60161 ③⑤ 18-60161-9 ① 18-6016A ② 18-6244 ÁNODO Reemplaza: 76214, 762142, 762142A1, 76214A5, 97-76214Q5, 786214A2, 97-762145, 200, 225, 250HP, V-155-V-200, & Todos Bravos, Alpha One, Gen II (1991 & sup) (roscado)</p>	 <p>③ 009365 ① 18-6066A ② 18-6243 ÁNODO Reemplaza: 43994A2, 821631Q1, 821631C, 821631B1, 821631A1 Para usar en R/MR/Alpha One (Colas & Transom 1983-90)</p>

Para usar en Alpha One SS (1982-89) ① Aluminio ② Magnesio ③ Zinc
④ Pack estandar 10 precio por pieza ⑤ Pack estándar 10 precio por pack
⑥ Pack estándar 2 precio por pack

— CONTIENE —

Ref #	Descripción	O.E. #	Cant.
18-2944	Junta retén	26-45577	1
18-2945	Junta	12-19183	1
18-7163	Aro tórico	25-33465	1
18-7159	Aro	25-31534	1
18-2002	Retén aceite	26-70019, 26-73838	2
18-0563	Retén	26-36556	1

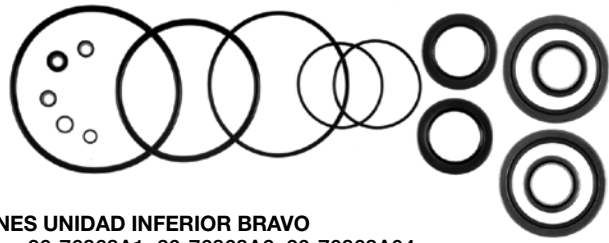

18-2645
KIT RETENES UNIDAD INFERIOR BRAVO
 Reemplaza: 26-76868A1, 26-76868A2, 26-76868A04
 Bravo I, II & III MODELOS

— CONTIENE —

Ref #	Descripción	O.E. #	Cant.
18-2945	Junta tornillo aloj. engranaje	12-19183	2
18-0894	Junta tapa agua	27-55810	1
18-2003	Retén aceite	26-823894	1
18-2049	Retén aceite	26-32511	1
18-2056	Retén aceite	26-965031	1
18-2944	Aro tórico	26-45577	1
18-3110	Cojinete	26-38970	1
18-7153	Aro tórico	25-25439	2
18-7161	Aro tórico	25-32546	1
18-7169	Aro tórico	25-70937	1
18-7445	Aro tórico	25-55801	1

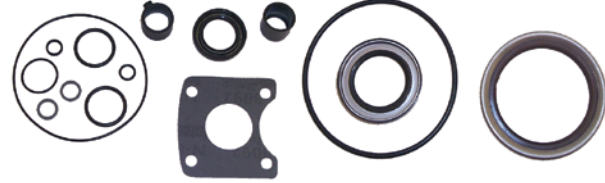

18-2648
KIT RETENES ENGRANAJES SUP
 Reemplaza: 26-32511A1
 S/N 1684188 & SUP
 Para #1 Units (Incluye ALPHA) (También se adapta 888 colas)
 S/N 3106717 & SUP

— CONTIENE —

Ref #	Descripción	O.E. #	Cant.
18-2919	Junta alojamiento a base bomba	27-42631-1	1
18-3110	Casquillo	26-38970	1
18-2002	Retén aceite	26-70019, 26-73838	1
18-2013	Retén aceite	26-16977	2
18-2014	Retén aceite	26-89238	1
18-2826	Junta aloj. engranajes a base bomba	27-85610-1	1
18-2914	Junta platina desgaste a bomba agua	27-85608-1	1
18-2915	Junta platina desgaste a bomba agua	27-85609-1	1
18-2944	Aro tórico	26-45577	1
18-2948	Junta	12-49221-1	1
18-7158	Aro tórico	25-30613	1
18-7159	Aro tórico	25-31534	1
18-7162	Aro tórico	25-33145	1
18-7176	Aro tórico	25-90011	1
—	Aro tórico	25-38099	1
18-2154	Casquillo eje inverso	23-30617A2	1
18-2076	Retén	26-12224	1
18-7426	Aro tórico	25-30271	1
18-2945	Junta	12-20260, 12-19183	2

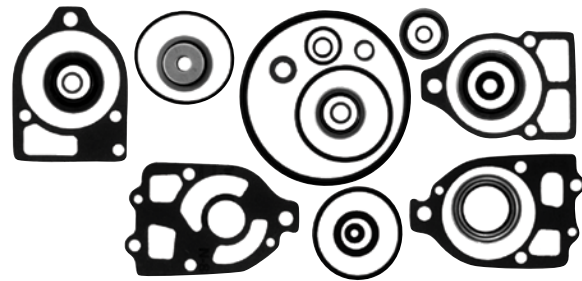

18-2652
KIT RETENES ENGRANAJES INFERIOR
 Reemplaza: 26-33144A2, 26-33144A1, 26-89238A1
 S/N 1684188 & SUP
 Para #1 Unidades (Incluyendo ALPHA)

— CONTIENE —

Ref #	Descripción	O.E. #	Cant.
18-2652	Kit retenes parte inferior	26-33144A2	1
18-1155	Cojinete a bolas	30-88957A1	1
18-1117	Cojinete piñón	31-42647A1	1
18-1143	Cojinete rodillos	31-36387A1	1
18-3719	Tuerca piñón	11-35921	1
18-2299	Arandela	14-79447	1
18-2298	Arandela	14-18323	1
18-1158	Cojinete agujas	31-30956	1
18-1159	Cojinete rodillos	31-35928A1	1
18-2285	Kit gruesos	15-47397A1	1
18-1157	Cojinete agujas	31-30895	1
18-2343	Arandela	12-982721	1
18-2294	Kit gruesos	2470	1



18-8208
KIT RETENES Y COJINETES
 Reemplaza: 31-803090T1
 Para: MR/Alpha Drive

— CONTIENE —

Ref #	Descripción	O.E. #	Cant.
18-2340	Arandela	12-31266	1
18-2076	Retén aceite	26-12224	1
18-7159	Retén aceite	25-31534	1
18-2002	Retén aceite	26-76868	1
18-3109	Tubo agua	23-29804	1
18-2154	Aloj. Cojinete	23-30617A2	1
18-3116	Alojamiento	46-96148A1	1
18-3017	Impulsor	47-89984	1
18-2914	Junta bomba agua	27-85608-1	1
18-7158	Aro tórico	25-30613	1
18-7176	Aro tórico	25-90011	1
18-2944	Junta aro retén	26-45577	1
18-7173	Aro tórico	25-30224	1
18-2826	Junta aloj. engranajes a base bomba	27-85610-1	1
18-2915	Junta bomba agua	27-85609-1	1
18-3117	Platina	32435	1
18-7162	Aro tórico	25-33145	1
18-2919	Junta bomba agua	27-42631-1	1
18-2801	Junta bomba agua	27-32438	1
18-7426	Aro tórico	35-30271	1
18-2945	Junta drenaje	26-20260, 12-19183	2
18-3110	Casquillo	26-38970	1
18-2013	Retén	26-16977	1
18-2014	Retén	26-89238	1



18-8370
KIT REACONDICIONAMIENTO COMPLETO CAJA ENGRANAJES
 Incluye bomba de agua y kit completo de retenes
 Para Mercuriser R/MR/ALPHA 1

Modelo	Año	Desde n° serie #	Hasta n° serie #	Kit Retenes	Retén	Asiento Retén	Kit Retén	Kit Retén aloj. eng.	Aro Coj.	Retén
60 / 80 / 90	1965-1972	1830753	3225967	N/D	N.L.A.	N/D	N/D	N/D	18-7160	18-2011
IA / IB / IC / EZ SHIFT	1964-1966	1684188	2065186	18-2648	18-2003	18-0577	N/D	18-2652	18-7159	18-2002
120 / 140	1967-1982	2062141	6225576	18-2648	18-2003	18-0577	N/D	18-2652	18-7159	18-2002
470 / 485	1976-1982	4208730	6225575	18-2648	18-2003	18-0577	N/D	18-2652	18-7159	18-2002
160 / 165	1967-1981	2065190	& SUP	18-2648	18-2003	18-0577	N/D	18-2652	18-7159	18-2002
888	1971-1977	3106717	& SUP	18-2648	18-2003	18-0577	N/D	18-2652	18-7159	18-2002
225 / 233	1974-1977	3856268	& SUP	18-2648	18-2003	18-0577	N/D	18-2652	18-7159	18-2002
888 / 228 / 250 / 260	1977-1982	4782330	6225576	18-2648	18-2003	18-0577	N/D	18-2652	18-7159	18-2002
R	1983	6225577	& SUP	18-2648	18-2003	18-0577	N/D	18-2652	18-7159	18-2002
MR ALPHA ONE	1984-1990	6225577	D469858	18-2648	18-2003	18-0577	18-8208	18-2652	18-7159	18-2002 ③
MR ALPHA ONE	1984-1990	6225577	D469858	18-2648	18-2003	18-0577	18-8208	18-2652	18-7159	18-2077 ①
MR ALPHA ONE	1984-1990	6225577	D469858	18-2648	18-2003	18-0577	18-8208	18-2652	18-7159	18-2076 ②
MR ALPHA ONE (CR)	1984-1990	6225577	D469858	18-2648	18-2003	18-0577	N.L.A.	18-2652	18-7159	18-2077 ①
MR ALPHA ONE (CR)	1984-1990	6225577	D469858	18-2648	18-2003	18-0577	N.L.A.	18-2652	18-7159	18-2076 ②
ALPHA ONE SS	1986-1989	A545004	& SUP	18-2648	18-2003	18-0577	N/D	18-2652	18-7159	18-2002 ③
ALPHA ONE SS	1986-1989	A545004	& SUP	18-2648	18-2003	18-0577	N/D	18-2652	18-7159	18-2077 ①
ALPHA ONE SS	1986-1989	A545004	& SUP	18-2648	18-2003	18-0577	N/D	18-2652	18-7159	18-2076 ②
APLHA ONE GEN II	1991-1995	D469859	F679999	18-2644	18-2003	18-0577	N/D	18-2646-1	18-7159	18-2077 ①
APLHA ONE GEN II	1991-1995	D469859	F679999	18-2644	18-2003	18-0577	N/D	18-2646-1	18-7159	18-2076 ②
APLHA ONE GEN II (CR)	1991-1995	D469859	F679999	18-2644	18-2003	18-0577	N.L.A.	18-2646-1	18-7159	18-2077 ①
APLHA ONE GEN II (CR)	1991-1995	D469859	F679999	18-2644	18-2003	18-0577	N.L.A.	18-2646-1	18-7159	18-2076 ②
APLHA ONE GEN II	1996-1997	F680000	K999999	18-2644	18-2003	18-0577	N/D	18-2646-1	18-7159	18-2077 ①
APLHA ONE GEN II	1996-1997	F680000	K999999	18-2644	18-2003	18-0577	N/D	18-2646-1	18-7159	18-2076 ②
APLHA ONE GEN II (CR)	1996-2010	F680000	& SUP	18-2644	18-2003	18-0577	N.L.A.	18-2646-1	18-7159	18-2077 ①
APLHA ONE GEN II (CR)	1996-2010	F680000	& SUP	18-2644	18-2003	18-0577	N.L.A.	18-2646-1	18-7159	18-2076 ②
APLHA ONE GEN II	1998-2010	L100040	& SUP	18-2644	18-2003	18-0577	N/D	18-2646-1	18-7159	18-2077 ①
APLHA ONE GEN II	1998-2010	L100040	& SUP	18-2644	18-2003	18-0577	N/D	18-2646-1	18-7159	18-2076 ②
BRAVO I	1988-2010	B664190	& SUP	18-2643	N/D	N/D	N/D	18-2645	18-7159	18-2002
BRAVO I X	2000-2010	M100001	& SUP	18-2643	N/D	N/D	N/D	18-2645	18-7159	18-2002
BRAVO I XR/XZ	2000-2010	M100001	& SUP	18-2643	N/D	N/D	N/D	N/D	18-7159	N/D
BRAVO II	1988-2010	B664190	& SUP	18-2643	N/D	N/D	N/D	18-2645	N/D	N/D ②
BRAVO II	1988-2010	B664190	& SUP	18-2643	N/D	N/D	N/D	18-2645	N/D	N/D ①
BRAVO II X	2000-2010	M100001	& SUP	18-2643	N/D	N/D	N/D	18-2645	N/D	N/D ②
BRAVO II X	2000-2010	M100001	& SUP	18-2643	N/D	N/D	N/D	18-2645	N/D	N/D ①
BRAVO III	1988-2010	B664190	& SUP	18-2643	N/D	N/D	N/D	18-2645	N/D	N/D
BRAVO III X	2000-2010	M100001	& SUP	18-2643	N/D	N/D	N/D	18-2645	N/D	N/D
BLACKHAWK	1994-1995	F186717	& SUP	18-2643	N/D	N/D	N/D	N/D	N/D	N/D
I	1963	1534570	1684187	18-2648	N/D	18-0577	18-2652	N/D	18-7157	18-2002
II	1962-1969	1474909	2671321	N/D	N/D	N/D	N/D	N/D	18-7159	N.L.A.
III	1968-1972	2373127	3002613	N/D	N/D	N/D	N/D	N/D	N/D	N/D
215E/H	1970-1972	2909035	2915034	N/D	N/D	N/D	N/D	N/D	N/D	N/D
TR	1973-1993	3377316	& SUP	N/D	N/D	N/D	N/D	N/D	N/D	N/D
TRS	1973-1993	3377316	& SUP	N/D	N/D	N/D	N/D	N/D	18-7159	N/D

① Interno ② Externo ③ Sin retén

<p>② 18-4456D</p>  <p>18-4456 TAPA ESCAPE Reemplaza: 34765A1, 34765A2 INCLUYE ABRAZADERA DE ACERO INOXIDABLE 3"</p>	<p>② 18-4457D</p>  <p>18-4457 TAPA ESCAPE Reemplaza: 12644A1, 12644Q01 INCLUYE ABRAZADERA ACERO INOXIDABLE 4"</p>	<p>② 18-4458D</p>  <p>18-4458 TAPA ESCAPE (Para escapes de 5" y 6") INCLUYE ABRAZADERA ACERO INOX</p>
---	--	--

② Referencias acabadas en "D" envasadas - Referencias normales no envasadas

RETÉN ACEITE

Ref #	O.E. #	Diámetro Eje (Pulgades.)	Dimensiones (pulg.)		Ref #	O.E. #	Diámetro Eje (Pulgades.)	Dimensiones (pulg.)	
			D.E.	Ancho				D.E.	Ancho
18-0172	26-97530	0.845	1.500	0.315					
18-0515	26-30530	0.540	1.004	0.303					
18-0516	26-30913	0.500	0.839	0.187					
18-0517	26-32911	1.100	1.260	0.127					
18-0519	26-14240	3.792	4.536	0.482					
18-0522	26-43036	1.045	1.474	0.187	18-2013	26-16977	0.875	1.25	0.188
18-0523	26-43993	1.640	2.132	0.282	18-2014	26-89238	0.875	1.5	0.312
18-0525	26-45587	0.390	0.628	0.124	18-2015	26-23517	0.75	1.25	0.25
18-0526	26-48443	0.750	1.379	0.256	18-2016	26-41953	1.187	1.875	0.25
18-0527	26-56397	0.750	1.127	0.343	18-2017	26-32121	0.75	1	0.125
18-0529	26-62818	1.640	2.256	0.319	18-2019	26-27163	0.688	1.124	0.25
18-0531	26-72785	0.790	1.880	0.248	18-2026 ①	26-16977	0.875	1.25	0.188
18-0537	26-85107	1.020	1.507	0.251	18-2048	26-24590	0.4	0.566	0.094
18-0578	26-67388	1.800	3.100	0.500	18-2049	26-32511	1.25	2.005	0.388
18-2002	26-76868	1.188	1.692	0.25	18-2050	26-55682	1	1.253	0.125
18-2004	26-20070	0.625	1	0.25	18-2051	26-69188	0.875	1.253	0.278
18-2003	26-823894	2.25	3	0.437	18-2052	26-69189	0.875	1.314	0.322
18-2004	26-20070	0.625	1	0.25	18-2053	26-70081	1.185	1.754	0.36
18-2006	26-897154	0.625	1.125	0.312	18-2054	26-8164641	0.375	0.75	0.243
18-2007	26-94038	1	1.5	0.312	18-2055	26-79831	0.75	1.127	0.149
18-2008	26-56788	0.875	1.25	0.375	18-2056	26-965031	0.875	1.375	0.250
18-2009	26-892361	0.375	0.75	0.25	18-2076 ①	26-12224	1.188	1.690	0.360
18-2010	26-897153	0.437	0.875	0.25	18-2077	26-14077	1.188	1.689	0.247
18-2011	26-90562	0.75	1.25	0.312	① Retén lineal				



ALOJAMIENTO TRANSMISIÓN

Modelo Cola	desde. S/N	hasta. S/N	Retén Aceite	Desc.	Cant.	Modelo Cola	Desde. S/N	Hasta. S/N	Retén Aceite	Desc.	Cant.
R/MR/Alpha I	6225577	SUP	18-2003	BC	1	250	4791300	4898729	18-2003	BC	1
Alpha I SS		Todos	18-2003	BC	1	250	4791300	4898729	18-2056	LDS	1
Alpha I SS		Todos	18-2056	LDS	1	260	4898730	6225576	18-2049	GC	1
Alpha I SS		Todos	18-2049	GC	1	260	4898730	6225576	18-2056	LDS	1
IA,IB,IC	1684188	2065189	18-2003	BC	1	260	4898730	6225576	18-2003	BC	1
I,IA,IB,IC	1534570	2065189	18-2049	GC	1	470	4208730	6225576	18-2056	LDS	1
IA,IB,IC	1749276	2065189	18-2056	LDS	1	470	4208730	6225576	18-2003	BC	1
II	1474909	2671321	18-2003	BC	1	470	4208730	6225576	18-2049	GC	1
120/140	2062141	6225576	18-2003	BC	1	485	4893835	SUP	18-2003	BC	1
120/140	2062141	6225576	18-2056	LDS	1	485	4893835	SUP	18-2049	GC	1
120/140	2062141	6225576	18-2049	GC	1	485	4893835	SUP	18-2056	LDS	1
160/165	2065190	SUP	18-2003	BC	1	888	3106717	SUP	18-2056	LDS	1
160/165	2065190	SUP	18-2049	GC	1	888	3106717	SUP	18-2049	GC	1
160/165	2065190	SUP	18-2056	LDS	1	888	3106717	SUP	18-2003	BC	1
225-S	3856268	4200499	18-2056	LDS	1	898/228	4782330	6225576	18-2049	GC	1
225-S	3856268	4200499	18-2049	GC	1	898/228	4782330	6225576	18-2003	BC	1
225-S	3856268	4200499	18-2003	BC	1	898/228	4782330	6225576	18-2056	LDS	1
233	4200500	SUP	18-2049	GC	1	BC Retén cojinete GC Retén engranaje LDS Retén eje dirección inferior					
233	4200500	SUP	18-2003	BC	1						
233	4200500	SUP	18-2056	LDS	1						
250	4791300	4898729	18-2049	GC	1						

ALOJAMIENTO ENGRANAJE

Modelo Cola	Desde. S/N	hasta. S/N	Retén aceite	Desc.	Cant.	Modelo Cola	Desde. S/N	Hasta. S/N	Retén Aceite	Desc.	Cant.
MR/Alpha I	6225577	SUP	18-2002	PS	2	IA,IB,IC	1684188	2065189	18-2014	WPB	1
R/MR/Alpha I	6225577	SUP	18-2009	SSB	1	IA,IB,IC	1684188	2065189	18-2002	PS	2
R/MR/Alpha I	6225577	SUP	18-2014	WPB,L	1	IA,IB,IC	1684188	2065189	18-2013	WPB	1
MR/Alpha I	6225577	SUP	18-2013	WPB,U	1	IA,IB,IC	1684188	2065189	18-2013	WP	1
R	6225577	SUP	18-2013	WPB,U	1	IA,IB,IC	1684188	2065189	18-2009	SSB	1
Alpha I SS	TODOS		18-2014	WPB,L	1	TRS	4794900	SUP	18-2002	PS	2
Alpha I SS	TODOS		18-2009	SSB	1	60	1830753	2063740	18-2009	SSB	1
Alpha I SS	TODOS		18-2013	WPB,U	1	60	1830753	2063740	18-2011	WPB,L	1
Alpha I SS	TODOS		18-2002	PS	2	60	1830753	2063740	18-2055	WPB,U	1
BRAVO I	B664190	SUP	18-2002	PS	2	60	1830753	2063740	18-2015	PS,O	1
I	1534570	1536617	18-2009	WPB	1	60	1830753	2063740	18-2011	PS,I	1
I	1534570	1684187	18-2009	SSB	1	80	2063741	2898029	18-2002	PS	2
I	1534570	1684187	18-2002	PS	2	80	2063741	2898029	18-2009	SSB	1
I	1534570	1684187	18-2013	WP	1	80	2063741	2898029	18-2055	WPB,U	1
I	1536618	1684187	18-2014	WPB	1	80	2063741	2898029	18-2011	WPB,L	1
I	1563354	1684187	18-2013	WPB	1	90	2898020	3225967	18-2009	SSB	1

ALOJAMIENTO ENGRANAJE (Cont.)											
Modelo Cola	Desde. S/N	Hasta. S/N	Retén Aceite	Desc.	Cant.	Modelo Cola	Desde. S/N	Hasta. S/N	Retén Aceite	Desc.	Cant.
90	2898020	3225967	18-2002	PS	2	260	4898730	6225576	18-2013	WPB,U	1
90	2898020	3225967	18-2011	WPB,L	1	260	4898730	6225576	18-2014	WPB,L	1
90	2898020	3225967	18-2055	WPB,U	1	280-TRS	4203750	4895399	18-2002	PS	2
120/140	2062141	6225576	18-2013	WPB,U	1	470	4208730	6225576	18-2009	SSB	1
120/140	2062141	4893634	18-2013	WP	1	470	4208730	6225576	18-2014	WPB,L	1
120/140	2062141	6225576	18-2014	WPB,L	1	470	4208730	6225576	18-2002	PS	2
120/140	2062141	6225576	18-2009	SSB	1	470	4208730	6225576	18-2013	WPB,U	1
120/140	2062141	6225576	18-2002	PS	2	485	4893835	SUP	18-2002	PS	2
160/165	2065190	SUP	18-2009	SSB	1	485	4893835	SUP	18-2009	SSB	1
160/165	2065190	SUP	18-2014	WPB,L	1	485	4893835	SUP	18-2013	WPB,U	1
160/165	2065190	SUP	18-2002	PS	2	485	4893835	SUP	18-2014	WPB,L	1
160/165	2065190	4890459	18-2013	WP	1	888	3106717	SUP	18-2014	WPB,L	1
160/165	2065190	SUP	18-2013	WPB,U	1	888	3106717	SUP	18-2009	SSB	1
225-S	3856268	4200499	18-2013	WPB,U	1	888	3106717	SUP	18-2013	WP	1
225-S	3856268	4200499	18-2014	WPB,L	1	888	3106717	SUP	18-2013	WPB,U	1
225-S	3856268	4200499	18-2002	PS	2	888	3106717	SUP	18-2002	PS	2
225-S	3856268	4200499	18-2009	SSB	1	898/228	4782330	6225576	18-2014	WPB,L	1
233	4200500	SUP	18-2009	SSB	1	898/228	4782330	6225576	18-2013	WPB,U	1
233	4200500	SUP	18-2013	WPB,U	1	898/228	4782330	6225576	18-2009	SSB	1
233	4200500	SUP	18-2002	PS	2	898/228	4782330	6225576	18-2002	PS	2
233	4200500	SUP	18-2014	WPB,L	1						
250	4791300	4898729	18-2013	WPB,U	1	PS			Retén eje hélice		
250	4791300	4898729	18-2014	WPB,L	1	PS,I			Eje hélice, retén interior		
250	4791300	4898729	18-2002	PS	2	PS,O			Eje hélice, retén exterior		
250	4791300	4898729	18-2009	SSB	1	SSB			Retén eje cambio		
255-TRS	3377316	4203749	18-2002	PS	2	WPB			Retén base bomba agua		
260	4898730	6225576	18-2009	SSB	1	WPB,L			Retén inf., base bomba agua		
260	4898730	6225576	18-2002	PS	2	WPB,U			Retén superior, base bomba agua		
						WP			Retén cuerpo bomba agua		

ARO TÓRICO

Ref #	O.E. #	Dimensiones		Ref #	O.E. #	Dimensiones		
		D. I.	Ancho (pulgadas)			D. I.	Ancho (pulgadas)	
				18-7161	② ⑤	25-32546	3.250	.070
				18-7162	② ⑤	25-33145	2.025	.135
				18-7163	② ⑤	25-33465	2.415	.100
				18-7164	② ⑤	25-33466	1.375	.100
				18-7165	② ⑤	25-32509	.500	.065
				18-7166	② ⑤	25-45254	.615	.065
				18-7167	② ⑤	25-861844	3.609	.139
				18-7168	② ⑤	25-48171	.370	.065
				18-7169	② ⑤	25-70937	3.500	.135
				18-7170	② ⑤	25-33504	1.365	.135
				18-7171	② ⑤	25-30529	1.920	.100
				18-7172	② ⑤	25-31305	3.250	.135
				18-7173	② ⑤	25-30224Q	1.875	.135
				18-7174	② ⑤	25-45711	.620	.100
				18-7175	② ⑤	25-62817	3.750	.270
				18-7176	② ⑤	25-896523	2.160	.100
				18-7177	② ⑤	25-53421	2.625	.065
				18-7180	③ ⑤	25-26802	.445	.090
				18-7188	②	25-805726	.361	.0635
				18-7198	② ⑤	25-45710	1.430	.100
				18-7411	② ⑤	25-35480	1.250	.100
				18-7413	② ⑤	25-62702	.301	.070
				18-7414	② ⑤	25-823683	1.989	.070
				18-7415	② ⑤	25-64966	3.739	.070
				18-7419	④ ⑤	25-69202	2.675	.103
				18-7420	③ ⑤	25-25439	.862	.139
				18-7421	① ⑤	25-16524	.150	.065
				18-7426	③ ⑤	25-30271	.740	.310
				18-7440-1	③	25-36318	.799	.103
				18-7445	③ ⑤	25-55801	.801	.070
				18-7449	①	25-97387	4.487	.103
				18-7459	①	25-20826	2.234	.139
				18-7464	①	25-39695	4.234	.139
				18-7467	③ ⑤	25-54030	2.987	.103
				18-7474	①	25-94288	1.239	.070
				18-7961		25-861844	3.650	.135

DRIVESHAFT HOUSING

Modelo Cola	Desde. S/N	Hasta. S/N	Retén aceite	Desc.	Cant.	Modelo Cola	Desde. S/N	Hasta. S/N	Retén aceite	Desc.	Cant.
R/MR/Alpha I	6225577	SUP	18-7153	UJ	2	233	4200500	UP	18-7169	BC	1
R/MR/Alpha I	6225577	SUP	18-7169	BC	1	250	4791300	4898729	18-7153	UJ	2
R/MR/Alpha I	6225577	SUP	18-7161	TC	1	250	4791300	4898729	18-7169	BC	1
Alpha I SS	TODOS		18-7161	TC	1	250	4791300	4898729	18-7161	TC	1
Alpha I SS	TODOS		18-7169	BC	1	255-TRS	3377316	4203749	18-7175	DSH	1
Alpha I SS	TODOS		18-7153	UJ	2	260	4898730	6225576	18-7169	DG	1
BRAVO (I/II)	B664190	SUP	18-7198	DSH	1	260	4898730	6225576	18-7161	TC	1
BRAVO (I/II)	B664190	SUP	18-7153	UJ	2	260	4898730	6225576	18-7170	BH	1
I	1534570	1684187	18-7127	DG	1	260	4898730	6225576	18-7153	UJ	2
I,IA,IB,IC	1534570	1777798	18-7165	USSL	1	280-TRS	4203750	4895399	18-7175	DSH	1
I,IA,IB,IC	1535212	2065189	18-7170	BH	2	470	4208730	6225576	18-7169	BC	1
IA,IB,IC	1684188	2065189	18-7153	UJ	2	470	4208730	6225576	18-7161	TC	1
IA,IB,IC	1684188	2065189	18-7169	BC	1	470	4208730	6225576	18-7153	UJ	2
II	2398798	2671321	18-7153	UJ	2	470	4893835	6225576	18-7170	BH	1
II SSM	TODOS		18-7175	DSH	1	485	4893835	SUP	18-7161	TC	1
II SSM	TODOS		18-7153	UJ	2	485	4893835	SUP	18-7170	BH	1
II TR	3377316	4794899	18-7175	DSH	1	485	4893835	SUP	18-7153	UJ	2
III/III SSM	TODOS		18-7115	FC	1	485	4893835	SUP	18-7169	DG	1
IV SSM ①	TODOS		18-7115	FC	1	888	3106717	SUP	18-7161	TC	1
I/IA/IB/IC	1534570	2065189	18-7161	TC	1	888	3106717	SUP	18-7169	BC	1
TR/TRS ③	4794900	SUP	18-7153	UJ	2	888	3106717	SUP	18-7153	UJ	2
TR/TRS	4794900	SUP	18-7175	DSH	1	898/228	4782330	6225576	18-7169	BC	1
120/140	2062141	6225576	18-7161	TC	1	898/228	4782330	6225576	18-7161	TC	1
120/140	2062141	6225576	18-7170	BH	1	898/228	4782330	6225576	18-7153	UJ	2
120/140	2062141	6225576	18-7169	DG	1	898/228	4898730	6225576	18-7170	BH	1
120/140	2062141	6225576	18-7153	UJ	2						
160/165	2065190	SUP	18-7170	BH	1						
160/165	2065190	SUP	18-7169	DG	1						
160/165	2065190	SUP	18-7153	UJ	2						
160/165	2065190	SUP	18-7161	TC	1						
215H	2782203	2909034	18-7153	UJ	2						
215H	2782203	2909034	18-7146	PC	1						
215E ②	2909035	2915034	18-7174	FC	1						
215E	2909035	2915034	18-7146	CC	1						
225-S	3856268	4200499	18-7153	UJ	2						
225-S	3856268	4200499	18-7169	BC	1						
225-S	3856268	4200499	18-7161	TC	1						
233	4200500	SUP	18-7161	TC	1						
233	4200500	SUP	18-7153	UJ	2						

- ① Diseño 1 ST
- ② 5/8" ID
- ③ Con transmisión Borg Warner
- BC Retén Cojinete
- BH Retén alojamiento correa
- CC Retén tapa transmisión
- DG Retén engranaje
- DSH Retén alojamiento transmisión
- FC Retén tapa frontal
- PC Retén tapa bujía
- TC Retén tapa alta
- USSL Retén eje gas
- UJ Retén cruceta

ALOJAMIENTO ENGRANAJES

Modelo cola	Desde. S/N	Hasta. S/N	Retén Aceite	Desc.	Cant.	Modelo Cola	Desde. S/N	Hasta. S/N	Retén Aceite	Desc.	Cant.
R/MR/Alpha I	6225577	SUP	18-7162	WPB	1	90	2898020	3225967	18-7153	SSB	1
MR/Alpha I	6225577	SUP	18-7176	WPB	1 ②	90	2898020	3225967	18-7155	WOAL	1
R/MR/Alpha I	6225577	SUP	18-7158	UDS	1	120/140	2062141	6225576	18-7153	SSB	1
R/MR/Alpha I	6225577	SUP	18-7159	PBH	1	120/140	2062141	6225576	18-7158	UDS	1
R/MR/Alpha I	6225577	SUP	18-7153	SSB	1	120/140	2062141	6225576	18-7159	PBH	1
Alpha I SS	TODOS		18-7159	PBH	1	120/140	2062141	6225576	18-7162	WPB	1
Alpha I SS	TODOS		18-7158	UDS	1	120/140	4893635	6225576	18-7114	GH	1 ③
Alpha I SS	TODOS		18-7153	SSB	1	160/165	2065190	SUP	18-7162	WPB	1
Alpha I SS	TODOS		18-7176	WPB	1 ②	160/165	2065190	SUP	18-7153	SSB	1
BRAVO I	B664190	SUP	18-7159	PBH	1	160/165	2065190	SUP	18-7158	UDS	1
BRAVO I/II	B664190	SUP	18-7163	GH	1	160/165	2065190	SUP	18-7159	PBH	1
I	1534570	1684187	18-7157	PBH	1	165	4890460	SUP	18-7114	GH	1 ③
I	1534570	1536617	18-7153	WPB	1	225-S	3856268	4200499	18-7153	SSB	1
I	1534570	1684187	18-7153	SSB	1	225-S	3856268	4200499	18-7162	WPB	1
I,IA,IB,IC	1534570	2065189	18-7158	UDS	1	225-S	3856268	4200499	18-7158	UDS	1
I,IA,IB,IC	1536618	2065189	18-7162	WPB	1	225-S	3856268	4200499	18-7159	PBH	1
IA,IB,IC	1684188	2065189	18-7159	PBH	1	233	4200500	SUP	18-7162	WPB	1
IA,IB,IC	1684188	1777798	18-7153	WPB	1	233	4200500	SUP	18-7158	UDS	1
IA,IB,IC	1684188	2065189	18-7153	SSB	1	233	4200500	SUP	18-7159	PBH	1
II	1474909	2671321	18-7159	PBH	1	233	4200500	SUP	18-7153	SSB	1
III	TODOS		18-7151	BRL	1	250	4791300	4898729	18-7159	PBH	1
III	TODOS		18-7174	BRS	1	250	4791300	4898729	18-7158	UDS	1
TRS	4794900	SUP	18-7159	PBH	1	250	4791300	4898729	18-7162	WPB	1
60	1830753	2063740	18-7153	SSB	1	250	4791300	4898729	18-7153	SSB	1
60	1830753	2063740	18-7160	PBH	1	255-TRS	3377316	4203749	18-7159	PBH	1
60	1830753	2063740	18-7155	WOAL	1	260	4898730	6225576	18-7162	WPB	1
60	1830753	2063740	18-7114	WOAS	1	260	4898730	6225576	18-7159	PBH	1
80	2063741	2898029	18-7157	PBH	1	260	4898730	6225576	18-7153	SSB	1
80	2063741	2898029	18-7155	WOAL	1	260	4898730	6225576	18-7158	UDS	1
80	2063741	2898029	18-7114	WOAS	1	260	4898730	6225576	18-7114	GH	1 ③
80	2063741	2898029	18-7153	SSB	1	280-TRS	4203750	4895399	18-7159	PBH	1
90	2898020	3225967	18-7114	WOAS	1	470	4208730	6225576	18-7159	PBH	1
90	2898020	3225967	18-7157	PBH	1	470	4208730	6225576	18-7162	WPB	1

⑤ Precio por pieza. Para pedir envasado añada 9 a la referencia.

ALOJAMIENTO ENGRANAJE (Cont.)											
Modelo Cola	Desde. S/N	Hasta. S/N	Retén aceite	Desc.	Cant.	Modelo cola	Desde. S/N	Hasta. S/N	Retén aceite	Desc.	Cant.
470	4208730	6225576	18-7158	UDS	1	①	2.019 DI				
470	4208730	6225576	18-7153	SSB	1	②	2.17 DI				
470	4893835	6225576	18-7114	GH	1	③	V-8 Solo motores				
485	4893835	SUP	18-7158	UDS	1	BRL	Retén grande cojinete				
485	4893835	SUP	18-7162	WPB	1	BRS	Retén pequeño cojinete				
485	4893835	SUP	18-7153	SSB	1	GH	Retén alojamiento engranaje				
485	4893835	SUP	18-7114	GH	1	PGH	Retén cojinete hélice				
485	4893835	SUP	18-7159	PBH	1	SSB	Casquillo eje hélice				
888	3106717	SUP	18-7162	WPB	1	UDS	Retén superior transmisión				
888	3106717	SUP	18-7158	UDS	1	WOAL	Retén grande adaptador agua y aceite				
888	3106717	SUP	18-7153	SSB	1	WOAS	Retén pequeño adaptador agua y aceite				
888	3106717	SUP	18-7159	PBH	1	WPB	Retén base bomba agua				
898/228	4782330	6225576	18-7158	UDS	1						
898/228	4782330	6225576	18-7153	SSB	1						
898/228	4782330	6225576	18-7159	PBH	1						
898/228	4782330	6225576	18-7162	WPB	1						
898/228	4898730	6225576	18-7114	GH	1						

ALOJAMIENTO FUELLE

Modelo Cola	Desde. S/N	Hasta. S/N	Retén Aceite	Desc.	Cant.	Modelo Cola	Desde. S/N	Hasta. S/N	Retén Aceite	Desc.	cant.	
R/MR/Alpha	16225577	SUP	18-7170	BH	1	470	4208730	6225576	18-7152	EE	1	
BRAVO (I/II)	B664190	SUP	18-7168	V	2	①	470	4208730	4893934	18-7170	BH	1
I	1534570	1641940	18-7165	GHB	2	485	4893835	SUP	18-7152	EE	1	
II	1474909	1475005	18-7151	SL	1	888	3106717	SUP	18-7170	BH	1	
II	1602186	2671321	18-7162	GHAS	1	888	3106717	SUP	18-7114	GH	1	
II	1732380	2671321	18-7172	GHAL	1	888	3106717	SUP	18-7152	EE	1	
III/III SSM/IV	TODOS		18-7159	BH	1	898/228	4782330	4898729	18-7170	BH	1	
60	1830753	2063740	18-7172	BH	1	898/228	4782330	4898729	18-7114	GH	1	
80	2063741	2898029	18-7172	BH	1	898/228	4782330	6225576	18-7152	EE	1	
90	2898020	3225967	18-7172	BH	1							
120/140	2062141	6225576	18-7152	EE	1	①	Con depósito de aceite					
160/165	2065190	SUP	18-7152	EE	1	BH	Retén alojamiento correo					
225-S	3856268	4200499	18-7170	BH	1	EE	Retén codo escape					
225-S	3856268	4200499	18-7152	EE	1	GH	Retén aloj. fuelle transom					
225-S	3856268	4200499	18-7114	GH	1	GHAL	Retén adaptador fuelle transom					
233	4200500	SUP	18-7152	EE	1	GHAS	Retén pequeño adaptador fuelle transom					
233	4200500	SUP	18-7114	GH	1	GHB	Retén tornillo					
233	4200500	SUP	18-7170	BH	1	SL	Retén dirección					
250	4791300	4898729	18-7152	EE	1	V	Retén válvula					
250	4791300	4898729	18-7114	GH	1							
250	4791300	4898729	18-7170	BH	1							
260	4898730	6225576	18-7152	EE	1							

BOMBA HIDRÁULICA

Modelo cola	Desde. S/N	Hasta. S/N	Retén aceite	Desc.	Cant.	Modelo Cola	Desde. S/N	Hasta. S/N	Retén aceite	Desc.	Cant.
R/MR/Alpha I	6225577	SUP	18-7168	CV	4	255-TRS	3377316	4203749	18-7168	CV	4
BRAVO (I/II)	B664190	SUP	18-7134	ORC	1	260	4898730	6225576	18-7168	CV	4
BRAVO (I/II)	B664190	SUP	18-7158	ORS	1	280-TRS	4203750	4895399	18-7168	CV	4
II	2398798	2671321	18-7168	CV	4	470	4208730	6225576	18-7168	CV	4
II TR	3377316	4794899	18-7168	CV	4	485	4893835	SUP	18-7168	CV	4
III/III SSM/IV	TODOS		18-7168	CV	4	888	3106717	SUP	18-7168	CV	4
TR/TRS	4794900	SUP	18-7168	CV	4	898/228	4898730	6225576	18-7168	CV	4
90	2898020	3225967	18-7168	CV	4						
120/140	2062141	6225576	18-7168	CV	4	CV	Válvula control				
160/165	2065190	SUP	18-7168	CV	4	ORC	Conector depósito aceite				
215H/E	2782203	2915034	18-7168	CV	4	ORS	Interruptor depósito aceite				
225-S	3856268	4200499	18-7168	CV	4						
233	4200500	SUP	18-7168	CV	4						

VÁLVULA REVERSA

Modelo cola	Desde. S/N	Hasta. S/N	Retén aceite	Desc.	Cant.	Modelo cola	Desde. S/N	Hasta. S/N	Retén aceite	Desc.	Cant.
R/MR/Alpha I	6225577	SUP	18-7174	VC	1	260	4898730	6225576	18-7174	VC	1
R/MR/Alpha I	6225577	SUP	18-7198	V	1	470	4208730	6225576	18-7198	V	1
II	2398798	2671321	18-7198	V	1	470	4208730	6225576	18-7174	VC	1
II	2398798	2671321	18-7174	VC	1	485	4893835	SUP	18-7174	VC	1
120/140	2062141	6225576	18-7198	V	1	485	4893835	SUP	18-7198	V	1
120/140	2062141	6225576	18-7174	VC	1	898/228	4782330	6225576	18-7174	VC	1
160/165	2065190	SUP	18-7198	V	1	898/228	4782330	6225576	18-7198	V	1
160/165	2065190	SUP	18-7174	VC	1						
250	4791300	4898729	18-7198	V	1						
250	4791300	4898729	18-7174	VC	1	V	Válvula retén				
260	4898730	6225576	18-7198	V	1	VC	Retén tapa válvula				

MERCURUISER				MERCURUISER			
							
POTENCIA HP	CIL	CHAMPION	REF PRONAUTIC	POTENCIA HP	CIL	CHAMPION	REF PRONAUTIC
110	4, 153 CID	RN5C	050951	280, 300 Tempest, 320 EFI	V8 283, 327, 305, 350 CID	RV15YC4	050928
110	4, 153 CID	RV15YC4	050928	350 Mag (Carb)	V8 283, 327, 305, 350 CID	RV9IMC	050973
140 HASTA 3826282	4, 181 CID	RN5C	050951	350 Mag EFI/MP HASTA 0F602199	V8 283, 327, 305, 350 CID	RV9IMC	050973
140 DESDE 3826283	4, 181 CID	RV15YC4	050928	350 Mag EFI GEN+ DESDE 0F800500	V8	RS12YC	050949
3.0 HASTA 0F353100	4, 181 CID	RV15YC4	050928	350 Mag MPI GEN+ DESDE 0F602000	V8	RS12YC	050949
3.0 DESDE 0L010042	4, 181 CID	RS12YC	050949	350 Mag MPI GEN+ DESDE 0L604000	V8	RS12PYP	050978
3.0 LX	4, 181 CID	RS12YC	050949	377 Scorpion DESDE 0L416146	V8 283, 327, 305, 350 CID	RS12YC	050949
470,165, 170, 485, 488, 180, 190	4, 224 CID	RS12YC	050949	5.0 L MPI	V8 283, 327, 305, 350 CID	RS12YC	050949
3.7L, 3.7LX	4, 224 CID	RS12YC	050949	5.0 L HASTA 0L000000	V8 283, 327, 305, 350 CID	RV9IMC	050973
140, 150, 160	4, 224 CID	RS12YC	050949	5.0 L GEN+ 0L015751	V8 283, 327, 305, 350 CID	RS12YC	050949
165 HASTA 2771483	6, 194, 230 & 292 CID	RN5C	050951	5.0 L EFI GEN+ 0L012052	V8 283, 327, 305, 350 CID	RS12YC	050949
165 DESDE 2771484	6, 194, 230 & 292 CID	RV15YC4	050928	5.0 LX	V8 283, 327, 305, 350 CID	RV9IMC	050973
200	6, 194, 230 & 292 CID	RN5C	050951	5.7 L HASTA 0L000000	V8 283, 327, 305, 350 CID	RV9IMC	050973
185	V6, 229 CID	RV15YC4	050928	5.7 L EFI HASTA 0L000000	V8 283, 327, 305, 350 CID	RV9IMC	050973
175,185,205	V6, 262 CID	RV15YC4	050928	5.7 L GEN+ DESDE 0L010037	V8 283, 327, 305, 350 CID	RS12YC	050949
262 MAG EFI GEN+ 0F80800-0L000000	V6, 262 CID	RS12YC	050949	5.7 L EFI GEN+ DESDE 0L010035	V8 283, 327, 305, 350 CID	RS12YC	050949
4.3L MPI	V6, 262 CID	RV15YC4	050928	5.7 LX, 5.7LX EFI	V8 283, 327, 305, 350 CID	RV9IMC	050973
4.3L HASTA 0F802999	V6, 262 CID	RV15YC4	050928	5.7 LX EFI GEN+	V8 283, 327, 305, 350 CID	RS12YC	050949
4.3LX DESDE 0F802999	V6, 262 CID	RV15YC4	050928	325 DESDE 3043030	V8 427, 454 & 482 CID	V63C	050946
4.3 GEN+ DESDE 0L010065	V6, 262 CID	RS12YC	050949	330, 330 (B-W), 370, 400, 400 Cyclone	V8 427, 454 & 482 CID	RV15YC4	050928
4.3LL EFI GEN+ DESDE 0L0120009	V6, 262 CID	RS12YC	050949	420, HP425, 440 Cyclone, HP450	V8 427, 454 & 482 CID	RV15YC4	050928
4.3LH GEN+DESDE 0L010044	V6, 262 CID	RS12YC	050949	454 Mag Alpha, Bravo, EFI/MP/MPI	V8 427, 454 & 482 CID	RV15YC4	050928
4.3LX GEN+ 0F803000-0L000000	V6, 262 CID	RS12YC	050949	460 Cyclone, 475 Turbo, HP525SC	V8 427, 454 & 482 CID	V63C	050946
4.3LXH GEN+ 0F803000+0L000000	V6, 262 CID	RS12YC	050949	7.4 L Alpha, 7.4 L Bravo	V8 427, 454 & 482 CID	RV15YC4	050928
888 DESDE 4169597 CULATAS 14 mm	FORD V8	RV15YC4	050928	7.4 L TR OB771113-OC407646	V8 427, 454 & 482 CID	RV15YC4	050928
233 CULATAS 14 mm HEADS	FORD V8	RV15YC4	050928	7.4 L MPI (L29) DESDE 0L010003	V8 427, 454 & 482 CID	RS12YC	050949
255 DESDE 4175499 CULATAS 14 mm	FORD V8	RV15YC4	050928	7.4 LX EFI, 7.4 LX MPI	V8 427, 454 & 482 CID	RV15YC4	050928
190	V8 283, 327, 305, 350 CID	RJ12YC	050980	HP465, HP500 (502 CID), HP500 EFI	V8 502, 540 & 572 CID	RV15YC4	050928
898, 200	V8 283, 327, 305, 350 CID	RV9IMC	050973	HP500 Bulldog 540, HP525 SC 454	V8 502, 540 & 572 CID	V63C	050946
225 DESDE 2278647	V8 283, 327, 305, 350 CID	RJ12YC	050980	HP575, HP600SC Bob-tail (502 CID)	V8 502, 540 & 572 CID	V63C	050946
228, 230	V8 283, 327, 305, 350 CID	RV9IMC	050973	HP800SC (572 CID)	V8 502, 540 & 572 CID	V63C	050946
250 DESDE 4768000	V8 283, 327, 305, 350 CID	RV15YC4	050928	502 MAG (CARB.), EFI/MA/MPI	V8 502, 540 & 572 CID	RV15YC4	050928
255	V8 283, 327, 305, 350 CID	RV15YC4	050928	600SC, 800SC	V8 502, 540 & 572 CID	V63C	050946
260	V8 283, 327, 305, 350 CID	RV9IMC	050973				

MERCURISER



MERCURISER



POTENCIA HP	CIL	NGK	REF. PRONAUTIC	POTENCIA HP	CIL	NGK	REF. PRONAUTIC
120 hasta TO3825578	4	BR6ES	050705	5.7 MPI MIE	8	ITR4A15	050601
140 hasta TO3825578	4	BR6ES	050705	5.7 Black Scorpion OM391852+	8	TR55	050877
2.5L 153,CID	4	BR6EF	050706	5.7 Black Scorpion OM391778+	8	TR55	050877
3.0L 181 CID desde OL010042	4	BPR6EFS	050857	350MAGEFIGEM+desde OF800500	8	BPR6EFS	050857
3.0L 181 CID hasta OF3355100	4	BR6ES	050705	350MAGEFI/MP desde OF602199	8	BR6FS	050831
3.0LX	4	BPR6EFS	050857	350MAGMPIGEN+ desde OF602000 al OM320489	8	BR6FS	050831
165 224 CID, 170 224 CID	4	BR6FS	050831	350MAGMPIGEN+ desde OM320590	8	TR55	050877
180 224 CID, 190 224 CID	4	BR6FS	050831	350MAGMPIGEN+Horizon del OL304700 al OM309999	8	TR5	050708
3.7L 224CID, 3,7LX224 CID	4	BR6FS	050831	350MAGMPIGEN+Horizon desde OM310000	8	TR55	050877
470 224CID, 485 224CID, 488 224CID	4	BR6FS	050831	350MAGMPI Alpha/Bravo	8	ITR4A15	050601
140, 150, 160	6	BR6ES	050705	350MAG MPI Horizon Alpha/Bravo	8	ITR4A15	050601
165 hasta TO2771483	6	BR6ES	050705	377 Magnum MPI Bravo	8	ITR4A15	050601
200, 175, 185, 205, 185 229 CID	6	BR6FS	050831	898.200	8	YR5	050709
262MAG EFI GEN+ delOF803800 al OL00000	6	BPR6EFS	050857	6.2 MPI MIE	8	ITR4A15	050601
4.3L hasta OF802999	6	BR6ES	050705	6.2 mpi Horizon MIE	8	ITR4A15	050601
4.3L EFI GEN+ desde OL012009	6	BPR6EFS	050857	MX62MPI hasta OM320613	8	BPR6EFS	050857
4.3L GEN+ desde OL010065	6	BPR6EFS	050857	MX6.2L MPI desde OM320614	8	TR55	050877
4.3 LH EFI GEN+ desde OL010044	6	BPR6EFS	050857	MX6.2 MPI Horizon desde OM320614	8	TR55	050877
4.3L MPI GEN+ desde OM322781	6	TR55	050877	Scorpion desde OL416146	8	BPR6EFS	050857
4.3LX hasta OF802999	6	BR6ES	050705	233	8	BPR6EFS	050857
4.3LX GEN+ desde OF803000 hasta OL00000	6	BPR6EFS	050857	255 hasta 4175498	8	BR6FS	050831
4.3LXH GEN+ desde OF803000 hasta OL00000	6	BPR6EFS	050857	255 desde 4175499	8	BPR6EFS	050857
250 desde 4768000 - 255 - 260	8	BR6FS	050831	888 desde 4169597	8	BPR6EFS	050857
280, 300 Tempest, 320 EFI, 350 MAG	8	BR6FS	050831	330	8	BR6ES	050705
5.0L hasta OL00000	8	TR5	050708	390	8	BR6ES	050705
5.0L EFI GEN+ desde OL015751	8	BPR6EFS	050857	420, 440 Ciclone, 454MAGALPHA	8	BR6FS	050831
5.0L MPI GEN+ desde OM320415	8	TR55	050877	454 Magnum Bravo, 454MAFEFHMPI	8	BR6FS	050831
5.0L MPI Alpha/Bravo	8	ITR4A15	050601	502MAG, 502MAGEFHMP,MPI	8	BR6FS	050831
5.0 LX	8	YR5	050709	7.4L ALPHA, 7.4L Bravo	8	BR6FS	050831
5.0 L MPI2002+	8	BPR6EFS	050857	7.4LMPI (L29)	8	BPR6EFS	050857
5.7I, 5.7LEFI hasta OL000000	8	BR6FS	050831	7.4LXEFI Bravo, MPIBravo	8	BR6FS	050831
5.7L EFIGEN+ desde OL010035	8	BPR6EFS	050857	7.4TR desde OB771113 hasta OC407646	8	BR6FS	050831
5.7L GEN+ desde OL010037	8	BPR6EFS	050857	HP425mHP450,HP465,HP500,502CID	8	BR6FS	050831
5.7LX, 5.7LX EFI	8	BR6FS	050831	8.1L, 8.1 SHO, 8.1 S Horizon (2000-2006)	8	TR55	050877
5.7LX EFI GEN+	8	BPR6EFS	050857	8.1 SHO, 8.1 S Horizon (2007 +)	8	IZFR7M	050602
5.7MPI Horizon MIE	8	ITR4A15	050601				

①18-5001D Display Package



**18-5001
KIT ENCENDIDO**
Reemplaza: 172525

—CONTIENE—

Ref #	O.E. #	Descripción
18-5157	580290	Juego de contacto
18-5200	580256	Condensador

Display Package



**18-5250
KIT ENCENDIDO**
Reemplaza: 172527

—CONTIENE—

Ref #	O.E. #	Descripción
18-5311	380538	Juego de contacto
18-5345	380537	Condensador
18-5418	384735	Rotor Delco 4 & 6 cil.

Display Package



**18-5251
KIT ENCENDIDO**
Reemplaza: 173619

—CONTIENE—

Ref #	O.E. #	Descripción
18-5314	382135	Juego de contacto
18-5338	382136	Condensador
18-5404-1	982211	Rotor
	18-5376	Tapa alta



**18-5256
KIT ENCENDIDO**
Reemplaza: 172531

—CONTIENE—

Ref #	O.E. #	Descripción
18-5314	382135	Juego de contacto
18-5338	382136	Condensador
18-5411	982342	Rotor

Mallory 8 cil. Tapa plana

①18-5258D Display Package



**18-5258
KIT ENCENDIDO**
Reemplaza: 173690, 987925

—CONTIENE—

Ref #	O.E. #	Descripción
18-5303	980893	Juego contacto
18-5347	980894	Condensador
18-5407	980892	Rotor

Prestolite 8 cil.

Display Package



**18-5260
KIT ENCENDIDO**
Reemplaza: 173829, 987926

—CONTIENE—

Ref #	O.E. #	Descripción
18-5303	980893	Juego de contacto
18-5347	980894	Condensador
18-5403	982880	Rotor



**18-5266
KIT ENCENDIDO**
Para: Distribuidor Flame Thrower 18-5481,
18-5482, 18-5483, 18-5477, 18-5478 y 18-5479

Display Package



**18-5268
KIT ENCENDIDO**

—CONTIENE—

Ref #	O.E. #	Descripción
18-5311	380538	Juego contacto
18-5345	380537	Condensador
18-5418	384735	Rotor
18-5385	380541	Tapa distribuidor Delco En línea 4 - Punto único

Display Package



**18-5269
KIT ENCENDIDO**

—CONTIENE—

Ref #	O.E. #	Descripción
18-5311	380538	Juego contacto
18-5345	380537	Condensador
18-5418	384735	Rotor
18-5386	980152	Tapa distribuidor Delco En línea 6 - punto único

Display Package



**18-5271
KIT ENCENDIDO**

—CONTIENE—

Ref #	O.E. #	Descripción
18-5314	382135	Juego contacto
18-5338	382136	Condensador
18-5404-1	982211	Rotor
18-5376	982209	Tapa distribuidor Mallory V-8 - Punto único - Top Terminal

Display Package



**18-5272
KIT ENCENDIDO**

—CONTIENE—

Ref #	O.E. #	Descripción
18-5314	382135	Juego contacto
18-5338	382136	Condensador
18-5411	982342	Rotor
18-5375	382133	Tapa distribuidor Mallory Flat V-8 - Punto único - Terminal lateral - Tapa plana

Display Package



**18-5275
KIT ENCENDIDO**

—CONTIENE—

Ref #	O.E. #	Descripción
18-5303	980893, 987136, 987894	Juego contacto
18-5347	980894, 987895	Condensador
18-5403	982880	Rotor
18-5352	984401	tapa distribuidor
		Prestolite V-8 - Punto único - Tapa con tornillo

APLICACIONES EMPIEZAN EN LA PÁGINA 554

① Referencias acabadas en "D" envasadas - Referencias normales no envasadas



**18-5276
KIT ENCENDIDO**
—CONTIENE—
Ref # O.E. # Descripción
18-5303 980893, 987136, juego cont.
987894
18-5347 980894, 987895 Condensador
18-5403 982880 Rotor
18-5353 984398 Tapa distribuidor
Prestolite V-6 - Punto único - Tapa con tornillos



**18-5277
KIT ENCENDIDO**
—CONTIENE—
Ref # O.E. # Descripción
18-5303 980893,
987136, 987894 Juego cont.
18-5347 980894, 987895 Condensador
18-5407 980892 Rotor
18-5369 982336 Tapa distribuidor
Prestolite V-8 - Punto único - Cierre clip



**18-5278
KIT ENCENDIDO**
Para: Delco EST V-6



**18-5279
KIT ENCENDIDO**
Para: Prestolite Electronic V-8
—CONTIENE—
Ref # Descripción O.E.#Cant.
18-5352 Tapa distribuidor 392-97661
18-5403 Rotor 392-90891



**18-5280
KIT ENCENDIDO**
Para: Delco EST En-Linea 4
—CONTIENE—
Ref # Descripción O.E.# Cant.
18-5361 tapa 986643 1
18-5406 Rotor, Delco 986651 1



**18-5281
KIT ENCENDIDO**
Para: Delco EST • V-8



**18-5283
KIT ENCENDIDO**
Para: Mallory punto unico
En-Linea 4
—CONTIENE—
Part # Descripción
18-5397 Tapa distribuidor
18-5404-1 Rotor
18-5314 Juego contacto
18-5338 Condensador



**18-5157
JUEGO CONTACTO**
Reemplaza: 580290



**18-5303
JUEGO CONTACTO**
Reemplaza: 980893,
987136, 987894



**18-5311
JUEGO CONTACTO**
Reemplaza: 380538



**18-5314
JUEGO CONTACTO**
Reemplaza: 382135



**18-5200
CONDENSADOR**
Reemplaza: 580256



**18-5338
CONDENSADOR**
Reemplaza: 382136



**18-5344
CONDENSADOR**
Reemplaza: 382125



**18-5345
CONDENSADOR**
Reemplaza: 380537



**18-5347
CONDENSADOR**
Reemplaza: 980894,
987895



**18-5403
ROTOR**
Reemplaza: 982880



**18-5404-1
ROTOR**
Reemplaza: 982211



**18-5405
ROTOR**
Reemplaza: 3854549
V-8
Para nuevos modelos GM
"Modulo sin Tapa"





















**18-5406
ROTOR**
Reemplaza: 986651
Usar con 18-5361
Tapa distribuidor



**18-5407
ROTOR**
Reemplaza: 980892

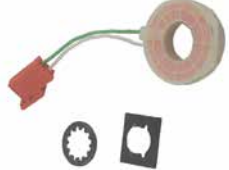

**18-5408
ROTOR**
Reemplaza: 3854311
V-6
Para nuevos modelos GM
"Modulo en Tapa"

 <p>18-5411 ROTOR Reemplaza: 982342</p>	 <p>18-5413 ROTOR Reemplaza: 987986</p>	 <p>18-5418 ROTOR Reemplaza: 384735</p>	 <p>18-5419 ROTOR Reemplaza: 380542</p>	 <p>18-5301 KIT ENCENDIDO Reemplaza: Para: tapa macho distribuidor v-8</p>
 <p>18-5302 KIT ENCENDIDO Reemplaza: Para: tapa macho distribuidor v-8</p>	 <p>18-29417 TAPA DISTRIBUIDOR Reemplaza: Mallory 270B Para: Mallory 6 cilindros</p>	 <p>18-5473 TAPA DISTRIBUIDOR Tapa distribuidor negra con terminales hembra para distribuidores</p>	 <p>18-5474 TAPA DISTRIBUIDOR Tapa distribuidor roja con terminales hembra para distribuidores</p>	 <p>18-5248 TAPA DISTRIBUIDOR OMC 3854217 Para: OMC 5.0L(1994-96), 5.8L(1994-96)</p>
 <p>18-5352 TAPA DISTRIBUIDOR Reemplaza: 984401 Prestolite</p>	 <p>18-5353 TAPA DISTRIBUIDOR Reemplaza: 984398 Prestolite</p>	 <p>18-5354 TAPA DISTRIBUIDOR Reemplaza: 3854548 V-8 Para nuevo modelo GM"modulo en tapa"</p>	 <p>18-5361 TAPA DISTRIBUIDOR Reemplaza: 986643</p>	 <p>18-5362 TAPA DISTRIBUIDOR Reemplaza: 3854331 V-6 Para nuevo modelo GM"Modulo en tapa"</p>
 <p>18-5369 TAPA DISTRIBUIDOR Reemplaza: 982336 con junta 18-5399</p>	 <p>18-5375 TAPA DISTRIBUIDOR Reemplaza: 382133</p>	 <p>18-5376 TAPA DISTRIBUIDOR Reemplaza: 982209 Mallory</p>	 <p>18-5384 TAPA DISTRIBUIDOR Reemplaza: 383587</p>	 <p>18-5385 TAPA DISTRIBUIDOR Reemplaza: 380541</p>
 <p>18-5386 TAPA DISTRIBUIDOR Reemplaza: 980152</p>	 <p>18-5397 TAPA DISTRIBUIDOR Reemplaza: 985218 Mallory 9-29418 Para: Ford 2.3L con Distribuidor Mallory (87-90)</p>	 <p>18-5107-1 MODULO DE ENCENDIDO Reemplaza: 3854003 4/6/8 cil</p>	 <p>18-5464 MODULO ENCENDIDO Para: Sierra 18-5481, 18-5482 y 18-5483 Billet DISTRIBUIDOR ELECTRONICO ALTAS PRESTACIONES (excepto HEI/EST)</p>	 <p>18-5108 SENSOR (Pick-Up bobina) Reemplaza: 3854001, 986642 4, V-6 y V-8 cil.</p>



18-26810
GM HEI 4 TERMINAL PIGTAIL
Para: GM HEI Distributores con 4 terminales



18-26811
GM HEI 2 TERMINAL PIGTAIL
Para: GM HEI Distribuidor con 2 terminales



18-26812
CONECTOR BOBINA GRIS



18-26813
CONECTOR BOBINA NEGRO



18-29322
KIT TAPA & ROTOR
Para: Ford HEI Distribuidor

CARACTERÍSTICAS



- ★ *Relleno con aceite para mejor refrigeración y gran durabilidad*
- ★ *Baja resistencia que produce una gran intensidad para un mejor encendido y economía de combustible*
- ★ *Más hilos maximizan la energía y la fiabilidad sobre el rango de las RPM*
- ★ *Se ajusta a los soportes existentes para una fácil instalación*



18-5466
BOBINA DE ENCENDIDO ALTO RENDIMIENTO
1.5 ohm (Aceite), negro - 8 cilindros: Flame-Thrower 40,000 voltios.
★ Usar con el kit de encendido de conversión electrónica original
★ Puede ser usado con otros sistema de encendido



18-5469
BOBINA DE ENCENDIDO DE ALTO RENDIMIENTO
3.0 ohm (Aceite), negro - 4 & 6 cilindros: Flame-Thrower 40,000 voltios.
★ Usar con kit de conversión de electrónica original
★ Puede ser usado con otros sistemas de Encendido



18-5472
BOBINA DE ENCENDIDO DE ALTO RENDIMIENTO
0.6 ohm (filtro aceite), negro - 4, 6, & 8 cilindros: Flame-Thrower 45,000 voltios.
★ Bobina de baja de resistencia 0.6 ohm diseñada para usar con kits de conversión electrónica de alto rendimiento Ignitor II
★ Compatible con sistemas de platino y condensador

Ref #	Descripción	Bobina recomendada	Resistencia Ohms	Ref #	Descripción	Bobina Recomendada	Resistencia Ohms
18-5293-1	Kit de conversión electrónica	18-5469	3.0	18-5288	Kit conversión electrónica alto rendimiento	18-5472	0.6
18-5294	Kit de conversión electrónica	18-5469	3.0	18-5289	Kit conversión electrónica alto rendimiento	18-5472	0.6
18-5295	Kit de conversión electrónica	18-5469	3.0	18-5290	Kit conversión electrónica alto rendimiento	18-5472	0.6
18-5296-2	Kit de conversión electrónica	18-5466	1.5	18-5481	Distribuidor Flame-Thrower	18-5472	0.6
18-5298	Kit de conversión electrónica	18-5466	1.5	18-5482	Distribuidor Flame-Thrower	18-5472	0.6
18-5299	Kit de conversión electrónica	18-5466	1.5	18-5483	Distribuidor Flame-Thrower	18-5472	0.6
18-5286	Kit de conversión electrónica alto rendimiento	18-5472	0.6				



18-5433
BOBINA ENCENDIDO
Reemplaza: 915735
Utiliza una resistencia externa
Para: 3.0L (1991 & sup), 5.7 EFI (1996 & sup) y 7.4L EFI (1995 & sup)



18-5437
BOBINA ENCENDIDO
Reemplaza: 383444, 378231
Metálico- 12 Volt
Utiliza resistencia externa (Para todas Aplicaciones)
Para: 1990 & anteriores con punto de encendido



18-5443
BOBINA ENCENDIDO
Reemplaza: 3854002
4 cil./V-8
Para: 3.0L (1991 & sup), 5.7 EFI (1996 & sup) & 7.4 EFI (1995 & sup)



18-5888
MÓDULO DE ENCENDIDO
Reemplaza: 987738
Para: V-8 colas
Para: 5.0, 5.7 GM (1986-90) 7.5 460 Ford (1987-91)



18-5889
MÓDULO DE ENCENDIDO
Reemplaza: 987739, 985902
Para: V-8 colas
Para: 5.0, 5.8 Ford (1986-90)



18-5890
MÓDULO DE ENCENDIDO
Reemplaza: 987740
Para: 2.3, 3.0, 4.3 (1986-90) & 2.5 (1986)



CARACTERÍSTICAS

- ★ Detecta los niveles de corriente en la bobina y ajusta el intervalo para mantener el valor máximo de energía en toda RPM.
- ★ Desarrolla, de media, 4 veces mas energía entre 3000 y 5000 RPM's
- ★ La energía de encendido es estable y la vida de la bobina aumenta cuando el nivel máx. de corriente es alcanzado antes de la chispa
- ★ Distribución más estable.
- ★ Usar con 18-5472 "Flame Thrower II" bobina para un rendimiento optimo



18-5285
KIT CONVERSIÓN ELECTRÓNICO
ALTO RENDIMIENTO
 Para: 4 Cilindros Distribuidores Delco



18-5286
KIT CONVERSIÓN ELECTRÓNICO
ALTO RENDIMIENTO
 Para: 6 Cilindros Distribuidores Delco



18-5287-1
KIT CONVERSIÓN ELECTRÓNICA
ALTO RENDIMIENTO
 Para: 6 Cilindros distribuidores Prestolite



18-5288
KIT CONVERSIÓN ELECTRÓNICA ALTO
RENDIMIENTO
 Para: Mayoría de los distribuidores con tapa ajustada con clips Prestolite V-8



18-5289
KIT CONVERSIÓN ELECTRÓNICO ALTO
RENDIMIENTO
 Para: Mayoría de los distribuidores con encaje la tapa abajo Prestolite V-8



18-5290
KIT CONVERSIÓN ELECTRÓNICA ALTO
RENDIMIENTO
 Para: Mayoría Mallory YL o YD 8 cilindros distribuidores con rotación hacia la derecha y hacia la izquierda



CARACTERÍSTICAS

- ★ Reemplaza platinos & condensador para un buen encendido.
- ★ Usa bobina, tapa y rotor estandar.
- ★ Fácil de instalar, una pieza, 2-conexiones de cables
- ★ Con una tolerancia de 1/4° en el encendido de 0 a 6000 RPM.

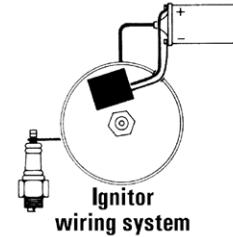
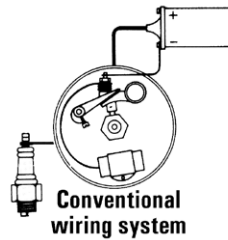

No compatible con módulos asistidos



18-5293-1
KIT CONVERSIÓN ELECTRÓNICA
 Para: Todos los Chevrolet V-6 Prestolite con tapa fijada con clips



18-5294
KIT CONVERSIÓN ELECTRÓNICA
 Para: 6 Cil. distribuidores Delco



18-5295
KIT CONVERSIÓN ELECTRÓNICA
 Para: Mayoría 4 Cil. distribuidores Prestolite (excepto IBM 7026)
 Para: Onan, Universal, Waukesha, Wisconsin

No compatibles con modulos asistidos

APLICACIONES COMIENZAN EN LA PÁGINA 554

① 18-5296-2D 



**18-5296-2
KIT CONVERSIÓN
ELECTRÓNICA**
Para: Mayoría Mallory YL & YD 8 cil.
Distribuidores con rotación sentido agujas
del reloj y sentido contrario

① 18-5297D 



**18-5297
KIT CONVERSIÓN
ELECTRÓNICA**
Para 4 Cil. distribuidores Delco

① 18-5298



**18-5298
KIT CONVERSIÓN
ELECTRÓNICA**
(Con tapa ajustada con clips)
Para: Mayoría distribuidores Prestolite
V-8

① 18-5299D 



**18-5299
KIT CONVERSIÓN
ELECTRÓNICA**
(Con tapa ajustada con clips)
Para: Mayoría distribuidores Prestolite
V-8
Usar con 18-5403 tipo rotor

No compatible con módulos asistidos





CARACTERÍSTICAS

- ★ Mejora el módulo de encendido con controles de ajuste para mejorar las prestaciones.
- ★ Cojinete y material de alta calidad para una larga vida

Standard Rotation

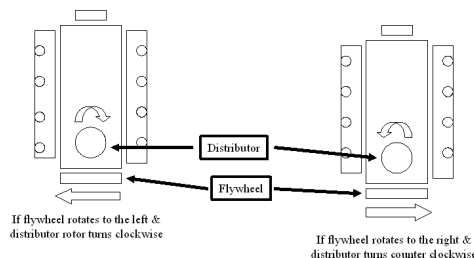
CCW Rotation

**18-5477
DISTRIBUIDOR ELECTRÓNICO**
Para: Motores Ford 302 V-8
Reemplaza kit Tapa/Rotor 18-5266



**18-5480
KIT COMPLETO CONVERSIÓN
DE ENCENDIDO**
Para: GM SB & BB con altura de cubierta standard
— CONTIENE —

Ref #	Descripción
18-5472	Bobina
18-8803-2	Juego de cable
18-5483	Distribuidor



**18-5481
DISTRIBUIDOR ELECTRÓNICO
ALTO RENDIMIENTO**
Para: Ford V-8 351 Windsor
Reemplaza Kit tapa/rotor: 18-5266



**18-5482
DISTRIBUIDOR ELECTRÓNICO ALTO
RENDIMIENTO**
Para: motores Ford V-8 351 Cleveland, 351M, 400,
429 y 460
Reemplaza kit tapa/roto: 18-5266



**18-5483
DISTRIBUIDOR ELECTRÓNICO ALTO
RENDIMIENTO**
Para: Bloque de motor marino Chevrolet pequeño y
grande (Altura cubierta estándar)
Reemplaza kit tapa/rotor: 18-5266

APLICACIONES EMPIEZAN EN LA PÁGINA 554

① Referencias acabadas en "D" envasadas - referencias normales no envasadas



18-5478
DISTRIBUIDOR ELECTRÓNICO

Para: motores Chrysler LA series V-8
Reemplaza Kit Tapa/Rotor 18-5266



18-5479
DISTRIBUIDOR ELECTRÓNICO

GM V-8 motores rotación reverso
Reemplaza Kit Tapa/Rotor 18-5266



18-5476
DISTRIBUIDOR

Para: Motores GM V-6 con Delco EST encendido HEI
Kit encendido 18-5278



18-5486-2
DISTRIBUIDOR ELECTRÓNICO
Reemplaza: Mallory YLM673AV
Rotación convencional

Para Chevrolet L4, 153 & 181 CID

— CONTIENE —

Ref #	Descripción
18-5397	Tapa distribuidor
18-5488	Modulo
18-5404-1	Rotor



18-5487-2
DISTRIBUIDOR ELECTRÓNICO
Reemplaza: 9-26309, Mallory YLM676AV
Rotación convencional

Para GM L6, 194, 230, 250, 292 CID

— CONTIENE —

Ref #	Descripción
18-5488	Modulo
18-5404-1	Rotor



18-5489-2
DISTRIBUIDOR ELECTRÓNICO
Reemplaza: Mallory YLM554CV
Rotación convencional

Para Ford V8 351W CID

— CONTIENE —

Ref #	Descripción
18-5376	Tapa distribuidor
18-5488	Modulo
18-5404-1	Rotor



18-5494-2
DISTRIBUIDOR ELECTRÓNICO
Reemplaza: Mallory YLM624AV
Rotación convencional

Para todos Chevrolet V8 incluye 482, 502, 540 CID
(Excepto 348, 409 y bloque grande para cubierta alta)

— CONTIENE —

Ref #	Descripción
18-5376	Tapa distribuidor
18-5488	Modulo
18-5404-1	Rotor



18-5495-2
DISTRIBUIDOR ELECTRÓNICO
Reemplaza: Mallory YLM512CV
Rotación convencional

Para Ford V8 302 CID

— CONTIENE —

Ref #	Descripción
18-5376	Tapa distribuidor
18-5488	Modulo
18-5404-1	Rotor



18-5496-2
DISTRIBUIDOR ELECTRÓNICO
Reemplaza: Mallory YLM567CV
Rotación convencional

Para Ford V8 351C — 460 CID

— CONTIENE —

Ref #	Descripción
18-5376	Tapa distribuidor
18-5488	Modulo
18-5404-1	Rotor

18-5484-1
DISTRIBUIDOR ELECTRÓNICO

Reemplaza: 3857400, 3850399
Último modelo HEI
Rotación convencional
V8 262-454 & 502 excepto 348/409 y bloques grandes
•diseñado como reemplazo de enchufe para distribuidores de combustible con sistema de inyección tipo GM.

— CONTIENE —

Descripción	Ref #
Tapa distribuidor	18-5354
Rotor	18-5405

Kit encendido 18-5281



18-5498-2
DISTRIBUIDOR ELECTRÓNICO

Reemplaza: 9-26307; Mallory YLM624BV
Para GM V8, 482, 502, 540 CID (Excepto 348, 409 & bloque grande) (Rotación reverso)



18-5339-1
DISTRIBUIDOR

Reemplaza: 9-26103; Mallory YL566AV
Para GM V8 327



18-5475
DISTRIBUIDOR

Para: 4 Cil. Motores GM con Delco EST encendido HEI
Kit encendido 18-5280



18-5309-1
DISTRIBUIDOR

Control contacto
Reemplaza: 980902; Mallory YL512CV
Para mayoría de motores Ford 302 CID V-8
Kit encendido 18-5251



18-5316-1
DISTRIBUIDOR

Reemplaza: Mallory YL624BV
Para mayoría GM V8 (Rotación reverso)



18-5312-1
DISTRIBUIDOR

Control contacto
Reemplaza: 981080; Mallory YL554CV
Para mayoría de motores Ford 351 CID V-8
Kit encendido 18-5251



18-5313-1
DISTRIBUIDOR

Control de contacto
Reemplaza: 985560; Mallory YL624MW
Para mayoría de motores GM V-8 (bloque pequeño y grande)
Kit encendido 18-5251



18-5315-1
DISTRIBUIDOR

Control contacto
Reemplaza: Mallory YL673AV
Para mayoría motores GM 4 Cil.(120 & 140 HP)
Kit encendido 18-5251



18-26110-1
DISTRIBUIDOR

Reemplaza: 9-26110; Mallory YL579AV
Para motores Chrysler V8, 273, 318 (1967 & Sup), 340 y 360 "LA"



18-26104-1
DISTRIBUIDOR

Reemplaza: 9-26104; Mallory YL567EV
Para Ford V8 351C



18-26112-1
DISTRIBUIDOR

Reemplaza: 9-26112; Mallory YL676AV
Para GM L6, 194, 230, 250, 292 CID (Rotación convencional)



OMC TABLA APLICACIÓN CONTACTO

Modelo	Año inicial	Año final	Cilindro	Distribuidor	Condensador	Dist. tapa	Rotor	kit encendido sin tapa	kit encendido con tapa	Juego cable bujía
2.3L	1987	1990	4	Mallory	18-5338	18-5397	18-5404-1	-	18-5283	18-8807-1
2.3L	1990	1990	4	Prestolite	18-5347	-	18-5403	18-5260	-	18-8807-1
2.5L	1981	1986	4	Delco	18-5345	18-5385	18-5418	18-5250	18-5268	18-8800-1
3.0L	1982	1990	4	Delco	18-5345	18-5385	18-5418	18-5250	18-5268	18-8800-1
3.0L	1990	1998	4	Delco EST	N/D	18-5361	18-5406	-	18-5280	18-8833-1
3.8L	1981	1985	6	Prestolite	18-5347	18-5353	18-5403	18-5262	18-5276	18-8801-1
4.3L	1985	1990	6	Prestolite ②	18-5347	18-5353	18-5403	18-5262	18-5276	18-8801-1
4.3L	1991	1993	6	Prestolite	N/D	18-5353	18-5403	-	-	18-8801-1
4.3L	1994	1998	6	Delco EST	N/D	18-53626	18-5408	-	18-5278	18-8835-1
5.0L (GM)	1979	1982	8	Prestolite ①	18-5347	18-5369	18-5407	18-5258	18-5277	18-8802-1
5.0L (GM)	1981	1988	8	Mallory	18-5338	18-5376	18-5404-1	18-5251	18-5271	18-8802-1
5.0L (GM)	1983	1988	8	Prestolite ②	18-5347	18-5352	18-5403	18-5262	18-5275	18-8802-1
5.0L (Ford)	1989	1990	8	Prestolite ②	18-5347	18-5352	18-5403	18-5262	18-5275	18-8806-1
5.0L (Ford)	1991	1996	8	Prestolite	N/D	18-5352	18-5403	-	18-5279	18-8806-1
5.0L (Ford)	1993	1996	8	Ford HEI	N/D	18-5248	18-5413	-	18-29322	18-8820-1
5.0L (GM)	1998	1998	8	Prestolite	N/D	18-5352	18-5403	-	18-5279	18-8801-1
5.0L (GM)	1998	1998	8	Delco EST	N/D	18-5354	18-5405	-	18-5281	18-8822-1
5.7L	1982	1990	8	Mallory	18-5338	18-5376	18-5404-1	18-5251	18-5271	18-8802-1
5.7L	1982	1990	8	Prestolite ②	18-5347	18-5352	18-5403	18-5262	18-5275	18-8802-1
5.7L	1991	1998	8	Prestolite ②	N/D	18-5352	18-5403	-	18-5279	18-8802-1
5.7L	1996	1998	8	Delco EST	N/D	18-5354	18-5405	-	18-5281	18-8822-1
5.8L	1989	1990	8	Prestolite ②	18-5347	18-5352	18-5403	18-5262	18-5275	18-8842-1
5.8L	1991	1996	8	Prestolite ②	N/D	18-5352	18-5403	-	18-5279	18-8842-1
5.8L	1993	1996	8	Ford HEI	N/D	18-5248	18-5413	-	18-29322	18-8820-1
7.4L	1988	1988	8	Mallory	18-5338	18-5376	18-5404-1	18-5251	18-5271	18-8802-1
7.4L	1988	1988	8	Prestolite ②	18-5347	18-5352	18-5403	18-5262	18-5275	18-8802-1
7.4L	1990	1991	8	Distributorless	-	-	-	-	-	18-8843-1
7.4L	1995	1998	8	Delco EST	N/D	18-5354	18-5405	-	18-5281	18-8832-1
7.5L	1987	1987	8	Prestolite ①	18-5347	18-5369	18-5407	18-5258	18-5277	18-8803-2
7.5L	1987	1989	8	Prestolite ①	18-5347	18-5352	18-5407	18-5258	18-5277	18-8803-2
8.2L	1984	1985	8	Mallory	18-5338	18-5376	18-5404-1	18-5251	18-5271	18-8802-1
8.2L	1984	1985	8	Prestolite ②	18-5347	18-5352	18-5403	18-5262	18-5275	18-8802-1
8.2L	1998	1998	8	Delco EST	N/D	18-5354	18-5405	-	18-5281	18-8832-1
80	1962	1968	4	TODOS	18-5200	-	-	18-5001	-	18-8800-1
90	1962	1968	4	TODOS	18-5200	-	-	18-5001	-	18-8800-1
100	1972	1973	4	Delco	18-5345	18-5385	18-5418	18-5250	18-5268	18-8800-1
110	1964	1964	4	Delco	18-5345	18-5385	18-5418	18-5250	18-5268	18-8800-1
120	1965	1981	4	Delco	18-5345	18-5385	18-5418	18-5250	18-5268	18-8800-1
140	1973	1981	4	Delco	18-5345	18-5385	18-5418	18-5250	18-5268	18-8800-1
150	1964	1966	6	Delco	18-5345	-	18-5419	-	-	-
155	1967	1972	6	Delco	18-5344	-	18-5419	-	-	-
165	1972	1976	6	Delco	18-5345	18-5386	18-5418	18-5250	18-5269	-
170	1974	1974	8	Prestolite ①	18-5347	18-5369	18-5407	18-5258	18-5277	18-8802-1
175	1975	1977	8	Prestolite ①	18-5347	18-5369	18-5407	18-5258	18-5277	18-8802-1
185	1967	1968	8	Mallory	18-5338	18-5375	18-5411	18-5256	18-5272	18-8802-1
185	1978	1980	8	Mallory	18-5338	18-5376	18-5404-1	18-5251	18-5271	18-8802-1
185	1978	1980	8	Prestolite ①	18-5347	18-5369	18-5407	18-5258	18-5277	18-8802-1
190	1974	1977	8	Prestolite ①	18-5347	18-5369	18-5407	18-5258	18-5277	18-8802-1
200	1966	1966	8	Delco	18-5345	18-5384	18-5300	-	18-5270	-
200	1967	1968	8	Delco	18-5344	18-5384	18-5300	18-5252	18-5270	-

① Clip tapa distribuidor ② Tornillo tapa distribuidor

APLICACIÓN CONTINUA EN LA SIGUIENTE PÁGINA

OMC TABLA APLICACIÓN CONTACTO

Modelo	Año inicial	Año final	Cilindro	Distribuidor	Condensador	Dist. tapa	Rotor	Kit encendido sin tapa	Kit encendido con tapa	Juego cable bujía
200	1979	1988	8	Mallory	18-5338	18-5376	18-5404-1	18-5251	18-5271	18-8802-1
200	1979	1981	8	Prestolite ①	18-5347	18-5369	18-5407	18-5258	18-5277	18-8802-1
210	1968	1970	8	Mallory	18-5338	18-5375	18-5411	18-5256	18-5272	18-8802-1
215	1971	1971	8	Mallory	18-5338	18-5375	18-5411	18-5256	18-5272	18-8802-1
225	1972	1976	8	Mallory	18-5338	18-5375	18-5411	18-5256	18-5272	18-8802-1
225	1978	1978	8	Mallory	18-5338	18-5376	18-5404-1	-	18-5271	18-8802-1
230	1979	1981	8	Mallory	18-5338	18-5376	18-5404-1	18-5251	18-5271	18-8802-1
230	1979	1981	8	Prestolite ①	18-5347	18-5369	18-5407	18-5258	18-5277	18-8802-1
230	1975	1976	8	Mallory	18-5338	18-5375	18-5411	18-5256	18-5272	18-8802-1
235	1971	1971	8	Mallory	18-5338	18-5375	18-5411	18-5256	18-5272	18-8802-1
235	1975	1977	8	Prestolite ①	18-5347	18-5369	18-5407	18-5258	18-5277	18-8802-1
240	1978	1978	8	Prestolite ①	18-5347	18-5369	18-5407	18-5258	18-5277	18-8802-1
245	1975	1975	8	Mallory	18-5338	18-5375	18-5411	18-5256	18-5272	18-8802-1
250	1970	1974	8	Mallory	18-5338	18-5375	18-5411	18-5256	18-5272	18-8802-1
250	1979	1979	8	Prestolite ①	18-5347	18-5369	18-5407	18-5258	18-5277	18-8802-1
260	1975	1976	8	Mallory	18-5338	18-5375	18-5411	18-5256	18-5272	18-8802-1
260	1979	1981	8	Mallory	18-5338	18-5376	18-5404-1	18-5251	18-5271	18-8802-1
260	1979	1981	8	Prestolite ①	18-5347	18-5369	18-5407	18-5258	18-5277	18-8802-1
290 JET	1974	1975	8	Mallory	18-5338	18-5375	18-5411	18-5256	18-5272	18-8802-1
305	1977	1979	8	Mallory	18-5338	18-5375	18-5411	18-5256	18-5272	18-8802-1
305	1980	1981	8	Mallory	18-5338	18-5376	18-5404-1	18-5251	18-5271	18-8802-1
305	1981	1981	8	Prestolite ①	18-5347	18-5369	18-5407	18-5258	18-5277	18-8802-1
350	1977	1979	8	Mallory	18-5338	18-5375	18-5411	18-5256	18-5272	18-8802-1
350	1980	1981	8	Mallory	18-5338	18-5376	18-5404-1	18-5251	18-5271	18-8802-1
350	1981	1981	8	Prestolite ①	18-5347	18-5369	18-5407	18-5258	18-5277	18-8802-1
454	1977	1979	8	Mallory	18-5338	18-5375	18-5411	18-5256	18-5272	18-8803-2
454	1980	1981	8	Mallory	18-5338	18-5376	18-5404-1	18-5251	18-5271	18-8803-2
454	1981	1981	8	Prestolite ①	18-5347	18-5369	18-5407	18-5258	18-5277	18-8803-2

① Clip tapa distribuidor ② Tornillo tapa distribuidor

 <p>MP28890 HOMBRE AL AGUA Reemplaza: 176288 Para: 1996 - Sup</p>	 <p>MP28880* HOMBRE AL AGUA Reemplaza: 432230 Para: 1995-Post.</p>	 <p>18-5225 KIT CABLE BUJÍAS Reemplaza: Mercury 84-99215A26, 84-813706A26 Kit Incluye 25 pies de cable de encendido 7 MM Hypalon de alma de cobre y un amplio surtido de 3 tipos de terminales.</p>
--	---	--

 <p>18-5226 CABLE ENCENDIDO Alma metálica 100' bobina 7mm Hypalon</p>	 <p>Pack. de 10 18-5224 18-5224-90 CABLE TERMINAL ENCENDIDO Reemplaza: Mercury 20121 OMC 510364</p>	 <p>Pack de 10 18-5750 18-5750-90 TAPA BUJÍAS UNIVERSAL Suministrado completo con conector terminal Reemplaza: OMC 581027, 580339</p>	 <p>18-5752 TAPA BUJÍAS UNIVERSAL 8mm</p>
--	---	--	--

③ Precio por pack

CABLES ENCENDIDO PREMIUM MARINE

Sierra MAGFORCE Cables de encendido electrónica protege todos tus dispositivos electrónicos y los controles electrónicos del motor de RFI y EMI, además de ofrecer la máxima cantidad de tensión. Ajuste exacto diseño asegura una fácil instalación - servicio gratuito.

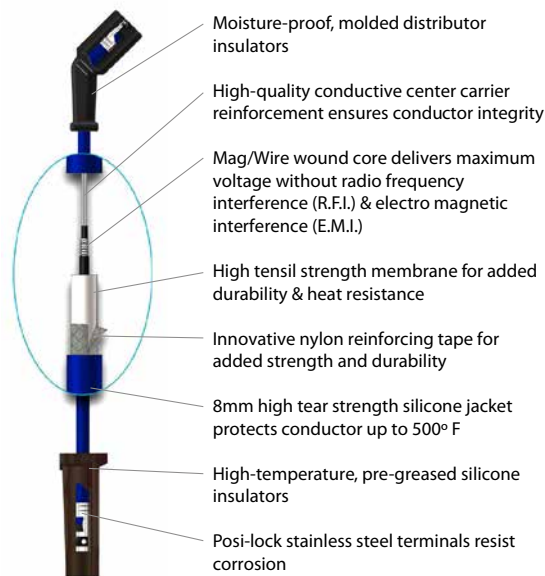

APLICACIONES CONTINUAN EN LA PÁGINA SIGUIENTE

OMC MARINE APLICACIÓN CABLES ENCENDIDO

Modelo	Cil.	Distribuidor	Año inicial	Año final	Juego cable enc
2.3L	4	Mallory	1987	1990	18-8807-1
2.3L	4	Prestolite	1990	1990	18-8807-1
2.5L	4	Delco	1981	1986	18-8800-1
3.0L	4	Delco	1982	1990	18-8800-1
3.0L	4	Delco EST	1990	1998	18-8833-1
3.8L	6	Prestolite	1981	1985	18-8801-1
4.3L	6	Prestolite ②	1985	1990	18-8801-1
4.3L	6	Prestolite	1991	1993	18-8801-1
4.3L	6	Delco EST	1994	1998	18-8835-1
5.0L (GM)	8	Prestolite ①	1979	1982	18-8802-1
5.0L (GM)	8	Mallory	1981	1988	18-8802-1
5.0L (GM)	8	Prestolite ②	1983	1988	18-8802-1
5.0L (Ford)	8	Prestolite ②	1989	1990	18-8806-1
5.0L (Ford)	8	Prestolite	1991	1996	18-8806-1
5.0L (Ford)	8	Ford HEI	1993	1996	18-8820-1
5.0L (GM)	8	Prestolite	1998	1998	18-8801-1
5.0L (GM)	8	Delco EST	1998	1998	18-8822-1
5.7L	8	Mallory	1982	1990	18-8802-1
5.7L	8	Prestolite ②	1982	1990	18-8802-1
5.7L	8	Prestolite ②	1991	1998	18-8802-1
5.7L	8	Delco EST	1996	1998	18-8822-1
5.8L	8	Prestolite ②	1989	1990	18-8842-1
5.8L	8	Prestolite ②	1991	1996	18-8842-1
5.8L	8	Ford HEI	1993	1996	18-8820-1
7.4L	8	Mallory	1988	1988	18-8802-1
7.4L	8	Prestolite ②	1988	1988	18-8802-1
7.4L	8	Distributorless	1990	1991	18-8843-1
7.4L	8	Delco EST	1995	1998	18-8832-1
7.5L	8	Prestolite ②	1987	1987	18-8803-2
7.5L	8	Prestolite ②	1987	1989	18-8803-2
8.2L	8	Mallory	1984	1985	18-8802-1
8.2L	8	Prestolite ②	1984	1985	18-8802-1
8.2L	8	Delco EST	1998	1998	18-8832-1

OMC MARINE APLICACIÓN CABLES ENCENDIDO

Modelo	Cil.	Distribuidor	Año inicial	Año final	Juego cable enc
80	4	ALL	1962	1968	18-8800-1
90	4	ALL	1962	1968	18-8800-1
100	4	Delco	1972	1973	18-8800-1
110	4	Delco	1964	1964	18-8800-1
120	4	Delco	1965	1981	18-8800-1
140	4	Delco	1973	1981	18-8800-1
170	8	Prestolite ①	1974	1974	18-8802-1
175	8	Prestolite ①	1975	1977	18-8802-1
185	8	Mallory	1967	1968	18-8802-1
185	8	Mallory	1978	1980	18-8802-1
185	8	Prestolite ①	1978	1980	18-8802-1
190	8	Prestolite ①	1974	1977	18-8802-1
200	8	Mallory	1979	1988	18-8802-1
200	8	Prestolite ①	1979	1981	18-8802-1
210	8	Mallory	1968	1970	18-8802-1
215	8	Mallory	1971	1971	18-8802-1
225	8	Mallory	1972	1976	18-8802-1
225	8	Mallory	1978	1978	18-8802-1
230	8	Mallory	1979	1981	18-8802-1
230	8	Prestolite ①	1979	1981	18-8802-1
230	8	Mallory	1975	1976	18-8802-1
235	8	Mallory	1971	1971	18-8802-1
235	8	Prestolite ①	1975	1977	18-8802-1
240	8	Prestolite ①	1978	1978	18-8802-1
245	8	Mallory	1975	1975	18-8802-1
250	8	Mallory	1970	1974	18-8802-1
250	8	Prestolite ①	1979	1979	18-8802-1
260	8	Mallory	1975	1976	18-8802-1
260	8	Mallory	1979	1981	18-8802-1
260	8	Prestolite ①	1979	1981	18-8802-1
290 JET	8	Mallory	1974	1975	18-8802-1
305	8	Mallory	1977	1979	18-8802-1

① clip tapa ② Encaje bajo tapa

OMC MARINE APLICACIÓN CABLES ENCENDIDO					
Modelo	Cil.	Distribuidor	Año inicial	Año final	Juego cable enc
305	8	Mallory	1980	1981	18-8802-1
305	8	Prestolite ①	1981	1981	18-8802-1
350	8	Mallory	1977	1979	18-8802-1
350	8	Mallory	1980	1981	18-8802-1

OMC MARINE APLICACIÓN CABLES ENCENDIDO					
Modelo	Cil.	Distribuidor	Año inicial	Año final	Juego cable enc
350	8	Prestolite ①	1981	1981	18-8802-1
454	8	Mallory	1977	1979	18-8803-2
454	8	Mallory	1980	1981	18-8803-2
454	8	Prestolite ①	1981	1981	18-8803-2

① clip tapa ② Encaje bajo tapa



18-5923
ARRANQUE, PMGR, FORD
 PMGR Reemplaza por 18-5903; 302CID,
 351CID motor Ford
 rotación agujas del reloj/Rotación standard



18-5927
ARRANQUE, PMGR, FORD
 PMGR reemplaza por 18-5917,
 2.3L arranque Ford.



18-6270
MOTOR DE ARRANQUE
 Reemplaza: 988013,
 984536

- Magneto permanente
- Heavy Duty
- 12 Volt
- 2 tornillos

- 1 agujero rosca
- Rotación estándar
- SAE J1171

Para: 460 Ford, OMC King Cobra



18-5919
MOTOR ARRANQUE
 Magneto permanente
 I/O arranque
 Para: Último modelo GM -
 12 3/4" volante
 Reemplaza: 988217
 Reemplaza Solenoide: 18-6287
 SAEJ1171
 1.7 KW



18-5920
MOTOR ARRANQUE
 Magneto permanente
 Para: 5.0 & 5.8 litros.
 Rotación estándar
 Reemplaza: 987811, 3854190
 Solenoide reemplazo: 18-6291

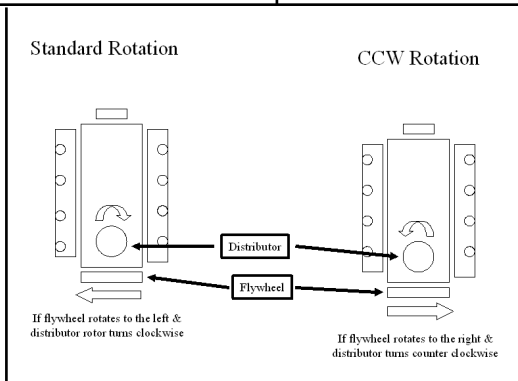

18-6276
MOTOR ARRANQUE
 Reemplaza: 984536, 988013

- 12 Volt
- Rotación estándar
- agujero rosca
- 460 Ford, OMC King Cobra



18-5911
MOTOR DE ARRANQUE
 (Heavy-Duty) (Sin núcleo)
 Para motores GM, montaje inferior, tornillos paralelos.
 Rotación estándar. 100-245 HP — 1970-1978 (GM)
 Reemplaza: 981078, 982121, 983444, 983790, 985966
 Solenoide reemplazo: 18-5837
 SAEJ1171



18-5907
STARTER
 (Heavy-Duty) (Sin núcleo)
 Montaje superior, entrada posterior.
 Motores GM y Ford.
 Reemplaza: 981289, 982202
 Solenoide reemplazo: 18-5837
 SAEJ1171



18-5908
MOTOR ARRANQUE
 (Heavy-Duty)
 Montaje superior, entrada posterior
 GM y motores ford. rotación estándar.
 Reemplaza: 981288, 982195, 984982, 986007
 Solenoide reemplazo: 18-5837
 SAEJ1171



18-5910
MOTOR ARRANQUE
 (Heavy-Duty)
 Bloques pequeño GM V-6 & V-8 con volante 14 1/4" y montaje inferior, Tornillos desplazados. Rotación estándar. 1986-1992 - V-6, V-8 (GM) y 1990-1993 OMC King Cobra
 Reemplaza: 984456, 986505
 Solenoide reemplazo: 18-5837
 SAEJ1171



18-5917
MOTOR ARRANQUE
 Reemplaza: 984628
 3 tornillos - Diámetro 4" Rotación estándar.
 Rotación estándar Para: Último modelo Ford V-8. Solenoide reemplazo: 18-5801



18-5903
MOTOR ARRANQUE
 (Rotación agujas del reloj)
 Montaje inferior, 2 tornillos. Motores ford. rotación agujas del reloj.
 Sin agujero rosca superior. Para rosca superior, 18-6276.
 Reemplaza: 980803, 981821
 Solenoide reemplazo: 18-5801



18-5913
MOTOR ARRANQUE
 (Rotación agujas del reloj)
 Magnético permanente. 2 tornillos 12V - 11 dientes. Para: Motores Chevy con volante 14". 1.7 KW
 Reemplaza: 3854751 SAEJ1171
 Reemplaza solenoide: 18-6287



MOTORES DE ARRANQUE COLAS OMC/OMC COBRA

Motor	Año	Motor arranque	Motor	Año	Motor arranque	Motor	Año	Motor arranque
3.0L	1982-92	18-5911	170	1974	18-5903	245	1972-75	18-5911
5.0L	1982-86	18-5911 ④	175	1975-77	18-5903	245 JET	1972-74	18-5911
5.0L	1986-88	18-5910 ⑤	185	1967-68,		250	1979	18-5903
2.5L	1982-86	18-5911		1978-80	18-5911	260	1975-76	18-5908 ①
3.8L	1981-86	18-5911	190	1974-77	18-5903	260	1975-76	18-5907 ②
4.3L	1985-86	18-5911	200	1966-68,		260	1979-81	18-5911
4.3L	1986-92	18-5910		1979-81	18-5911	262 CID	1989	18-5910
5.7L	1982-86	18-5911	210	1968-72	18-5911 ①	290	1975	18-5908 ③
5.7L	1986-92	18-5910	215	1971	18-5911	305 CID	1977-80,82	18-5908 ①
100	1972-73	18-5911	225	1972-76,		305 CID	1977-80,82	18-5907 ②
110	1964	18-5911		1978	18-5911 ①	350 CID	1977-80,82	18-5908 ①
120	1965-81	18-5911	230	1975-76	18-5908 ①	350 CID	1977-80,82	18-5907 ②
140	1973-81	18-5911	230	1975-76	18-5907 ②	350 CID	1988-91	18-5910
140 JET	1973	18-5911	230	1979-81	18-5911	370 CID	1988	18-5908
150	1964-66	18-5911	235	1971	18-5911	454 CID	1977-80,82	18-5908 ①
155	1967-72	18-5911	235	1975-77	18-5903	454 CID	1977-80,82	18-5907 ②
165	1972-76	18-5911	240	1978	18-5903	454 CID	1990-92	18-5910
						502 CID	1992	18-5910

① Motores de rotación estándar.

② Motores con contra-rotación.

③ Motores con modelo número sufijo "R2" or "R3"

④ Motores modelo '86 con número sufijo "WB"

⑤ Motores modelo '86 con número sufijo "XS"



18-5717
JUEGO ESCOBILLAS
Reemplaza:
Delco 1984462



18-8412
EXTENSOR DE ESPÁRRAGO DE ARRANQUE
Alarga los terminales del solenoide en arranques PMGR.



18-5811
SOLENOIDE MOTOR ARRANQUE
Reemplaza: 3850216
Para: PG 260 serie motor arranque, GM V6 & V8 (1983-sup)



18-5801
SOLENOIDE
Reemplaza: 985064, 586842, 586730
Base a tierra

① **18-5801D** Display Package



18-5803
SOLENOIDE
Reemplaza: 979774



18-5807
SOLENOIDE
Reemplaza: 378444
Prestolite SAW4206



18-6291
SOLENOIDE
Reemplaza: 3854194 y Volvo Penta 3854194-2
Para: Ford en últimos modelos 5.0L, 5.8L, OMC y Volvo Penta



18-5814
SOLENOIDE
Reemplaza: 172869, 581528
12 Volt, Base aislada

① **18-5814D** Display Package

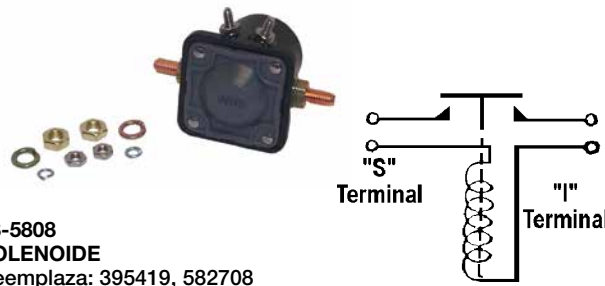

18-5808
SOLENOIDE
Reemplaza: 395419, 582708

① **18-5808D** Display Package

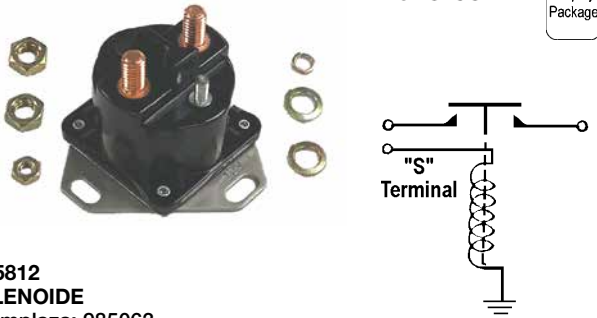

18-5812
SOLENOIDE
Reemplaza: 985063

① **18-5812D** Display Package



18-5837
SOLENOIDE
Reemplaza: 985799, 986620
Delco 1114531



18-5838
SOLENOIDE
Reemplaza:
Delco 1114356, 1114458



CABLES DE BATERÍAS
Cable calibrado con terminales soldados en cada extremo. Acepta tornillos de 3/8"

Ref.	long.	Color	cal.	Ref.	long.	Color	cal.
BC88523	2'	rojo	4	BC88563	6'	rojo	2
BC88533	2'	negro	4	BC88573	6'	negro	2
BC88543	4'	rojo	2	BC88583	8'	rojo	1
BC88553	4'	negro	2	BC88593	8'	negro	1

① Referencias acabadas en "D" envasadas - Referencias normales no envasadas

APLICACIÓN SOLENOIDE

HP	Año	Escobillas Motor de arranque	Solenoides Motor arranque	Solenoides arranque	Solenoides Tilt	Solenoides Trim
80	1969	—	N/D	18-5808	N/D	18-5808
88	1964	—	N/D	18-5807	N/D	18-5807
90	1965-71	—	N/D	18-5808	N/D	18-5808
100	1972-73	18-5717	18-5838	18-5803	N/D	18-5803
110	1964	18-5717	18-5838	18-5807	N/D	18-5807
120	1965-71	18-5717	18-5838	18-5808	N/D	18-5808
120	1972-77	18-5717	18-5838	18-5803	18-5803	18-5803
120	1978-81	18-5717	18-5838	—	—	—
140	1973-77	18-5717	18-5838	18-5803	18-5803	18-5803
140	1978-81	18-5717	18-5838	—	—	—
145	① 1973	—	18-5838	18-5803	N/D	N/D
150	1964	18-5717	18-5838	18-5807	N/D	18-5807
150	1965-66	18-5717	18-5838	18-5808	N/D	18-5808
155	1967-72	18-5717	18-5838	18-5808	N/D	18-5808
165	1972-76	18-5717	18-5838	18-5803	18-5803	18-5803
170	1974	—	N/D	18-5801	N/D	18-5803
175	1975-78	—	N/D	18-5801	N/D	18-5803
185	1967-68	18-5717	18-5838	18-5808	N/D	18-5808
185	1978-80	18-5717	18-5838	—	—	—
190	1974-78	—	N/D	18-5801	N/D	18-5803
200	1966-78	18-5717	18-5838	18-5808	N/D	18-5808
200	1979-81	—	18-5838	—	—	—
210	1968-70	18-5717	18-5838	18-5808	N/D	18-5808
210	② 1970-72	18-5717	18-5838	18-5808	N/D	N/D
215	1971	18-5717	18-5838	18-5808	N/D	18-5808
225	1972	18-5717	18-5838	18-5808	N/D	18-5808
225	1973	18-5717	18-5838	18-5803	N/D	18-5808
225	1974-76	18-5717	18-5838	18-5803	N/D	18-5803
225	1978	18-5717	18-5838	—	—	—
225	② 1973-74	18-5717	18-5838	18-5808	N/D	N/D
230	② 1975-76	18-5717	18-5838	18-5803	N/D	N/D
230	1979-81	18-5717	18-5838	—	—	—
235	1971	18-5717	18-5838	18-5808	N/D	18-5808
235	1975-78	—	N/D	18-5801	N/D	18-5803
245	1972	18-5717	18-5838	18-5808	N/D	18-5808
245	1973	18-5717	18-5838	18-5803	N/D	18-5808
245	1974-75	18-5717	18-5838	18-5803	N/D	18-5803
245	① 1972-75	18-5717	18-5838	18-5808	N/D	N/D
250	② 1970-74	—	18-5838	18-5808	N/D	N/D
260	② 1975-76	18-5717	18-5838	18-5803	N/D	N/D
260	1979-81	18-5717	18-5838	—	—	—
290	① 1974-75	18-5717	18-5838	18-5808	N/D	N/D
305	② 1977-82	18-5717	18-5838	—	N/D	N/D
350	② 1977-82	18-5717	18-5838	—	N/D	N/D
454	② 1977-82	18-5717	18-5838	—	N/D	N/D
2.5	1982	18-5717	18-5838	—	—	—
2.5	1983-86	18-5717	18-5837	—	—	—
3	1982	18-5717	18-5838	—	—	—
3	1983-86	18-5717	18-5837	—	—	—
3.8	1981-82	18-5717	18-5838	—	N/D	—
3.8	1983-86	18-5717	18-5837	—	N/D	—
4.3	1985-86	18-5717	18-5837	—	N/D	—
5	1982	18-5717	18-5838	—	—	—
5	1983-86	18-5717	18-5837	—	—	—
5.7	1982	18-5717	18-5838	—	—	—
5.7	1983-86	18-5717	18-5837	—	—	—

① Jet ② Intraborda

APLICACIÓN SOLENOIDE OMC COBRA

HP	Año	Escobillas Motor arranque	Solenoides Motor de arranque	Solenoides Arranque	Solenoides Trim
262	1989	N/D	18-5837	18-5812	N/D
350	1988	N/D	18-5837	18-5812	18-5812
350	1989	N/D	18-5837	18-5812	N/D
350	1990-91	N/D	18-5837	18-5801	N/D
351	1992	—	—	18-5801	N/D
370	1988	N/D	—	18-5812	18-5812
370	1989	N/D	—	18-5812	N/D
454	1990	—	—	18-5801	N/D
454	1991-92	N/D	18-5837	18-5801	N/D
460	1989-90	N/D	—	18-5801	N/D
502	1992	N/D	18-5837	18-5801	N/D
2.3	1987-88	N/D	—	18-5801	18-5812
2.3	1989-90	N/D	—	18-5801	N/D
2.5	1986	18-5717	18-5837	18-5812	18-5812
3	1986-88	18-5717	18-5837	18-5812	18-5812
3	1989-90	18-5717	18-5837	18-5812	N/D
3	1991-92	18-5717	18-5837	18-5801	N/D
4.3	1986-88	18-5717	18-5837	18-5812	18-5812
4.3	③ 1989-90	18-5717	18-5837	18-5812	N/D
4.3	④ 1990-92	18-5717	18-5837	18-5801	N/D
5	1986-88	18-5717	18-5837	18-5812	18-5812
5	1989-92	18-5717	—	18-5801	N/D
5.7	1986-88	18-5717	18-5837	18-5812	18-5812
5.7	1989	18-5717	18-5837	18-5812	N/D
5.7	1990-92	18-5717	18-5837	18-5801	N/D
5.8	1989-92	N/D	—	18-5801	N/D
7.5	1987	18-5717	—	18-5801	18-5812

③ 1990 Modelos con 2 cuerpos carbs④ 1990 Modelos con 4 cuerpos carbs.

18-5711
REGULADOR VOLTAJE
 Reemplaza: 383440
 Prestolite: VSH-6201 AFY
 12 Volt



Años	Modelo	Alternador o Generador
1964-66	110, 150 HP	ALK-6222, A, AYS
1967-81	80, 90, 120, 140, 155, 165, 175	ALK-6222, A, AY, Y, AYS
	185, 190, 200, 210, 225, 230, 235,	ANK-65201S, Y
	250, 260 HP & 305, 350, 454 CID	ALK-6210, A

18-6261
ALTERNADOR
 Reemplaza: 987774, 3857561,
 3854182, 3854809, 3856600, 3860171
 Para: 3.0L, 4.3L, 5.7L, 7.4L (1995-98), 5.0L, 5.8L, 8.2L
 (1993-98)
 Para: Delco



18-6260
ALTERNADOR
 OMC Cobra 12 Volt, 51
 Amp, regulador interno, Negativo,
 Polea de renura única
 Para: Prestolite/Motorola



18-6841
ALTERNADOR
 Reemplaza: 983424, 836, 247
 Para: 37-63A Aplicaciones marinas



18-5957
ALTERNADOR
 Reemplaza: 982364
 (3-cables) (68 AMP)
 Reemplaza Mando, Motorola y equipo original Delco. Usa las mismas conexiones eléctricas y montaje.
 Equipado con ventilador y polea. SAEJ1171



18-2192
CABLE CAMBIO ELÉCTRICO
 Reemplaza: 379628

APLICACIÓN CABLE CAMBIO ELÉCTRICO

Año	HP
1964	110 ②, 150
1965	120 ①, 150
1966	120 ①, 150, 200
1967	120 ①, 155, 185, 200
1968	120, 155, 185, 200, 210
1969-70	120, 155, 210
1971	120, 155, 215, 235
1972-73	100, 120, 155, 165, 225, 245
1974	120, 140, 165, 170, 190, 225, 245
1975	120, 140, 165, 175, 190, 225, 235, 245
1976	120, 140, 165, 175, 190, 225, 235
1977	120, 140, 175, 190, 235

① Heavy Duty ② SU12M, SUE 12M

③ **18-5705D**

18-5705
RELÉ POWER TRIM
 Reemplaza: 582472,
 584416, 586224
 5 Terminales



tipo único - Doble emp - 12 Volt
 Contacto abierto: 40 Amps Resistencia
 30 Amps Conductividad
 Contacto cerrado: 20 Amps Resistencia
 15 Amps Conductividad



18-6257
MOTOR TILT/TRIM
 Reemplaza: 983195, 982957
 1982-85 Modelos con motor hidráulico levantados para
 montaje de bomba



18-6754
MOTOR TILT
 Reemplaza: 382138
 Prestolite ETK 4102, ETK 4001, ETK 4101
 (todos los modelos 1963-77)



18-6755
MOTOR TILT
 Reemplaza: 982706, 982058
 Prestolite EVD 4001, EVD 4002
 (Todos Excepto 2.5L, 3.0L - 1978-85)



18-6764
MOTOR TILT/TRIM
 Reemplaza: 982073,
 983318, 982069
 Para: OMC Stringer y Cobra
 "Select Trim" 3-cables de Conexión
 1979-85 Colas (2.5L & 3.0L)



18-6779
MOTOR TRIM
 Reemplaza: 986280, 3853945
 Para: 1990 & 1994 sistema King Cobra Trim



18-6814
MOTOR TRIM
 Reemplaza: 984356
 OMC Cobra



18-6823
CABLEADO
 Reemplaza: Universal
 Convierte motores de Trim y Tilt de 3 a 2 cables



18-6950
18-6950-9 ①
FUSIBLE POWER TRIM
 (50 amp)
 Reemplaza: 982019



18-9802
PISTOLA POWER TRIM
 Hasta 10,000 RPM's



18-7601
SENSOR DE TEMPERATURA
 Reemplaza: 3854158
 8 cil
 5.0L, 5.8 L, EFI (1994-96)



18-7684
SENSOR DE PICADO
 Reemplaza: 3850396
 Para: 4.3L TBI(1996-98), 5.0L TBI(1998), 5.7L
 TBI(1996-98), 7.4L(1995-98), 8.2L(1998)



18-7677
SENSOR DE GOLPE
 Reemplaza: 3850357



18-7679
SENSOR DE GOLPE
 Reemplaza: 3854905



18-7703
SENSOR DE GOLPE
 Reemplaza: 3854512



18-7689
INYECTOR COMBUSTIBLE
 Reemplaza: 3855182

① Precio por pack

TODOS LOS CARBURADORES INCLUYEN JUNTA BASE

- Precisión remanufacturada para alcanzar o exceder las especificaciones OEM
- Recalibrados y reprogramados para maximizar la eficiencia y rendimiento del combustible
- Prueba de flujo por todas partes del regulador a todos los carburadores
- La mezcla de combustible y ajustes ociosos son predeterminados para asegurar que sólo el menos ocioso y ajustes de estrangulador son necesarios durante la instalación.
- Todas las bases son revestidas de nuevo y los manguitos del eje regulador sustituidos



18-7635
CARBURADOR
(REMANUFACTURADO)
300 CFM Holley 2V
Use junta de recambio 18-0360



18-7636
CARBURADOR
(REMANUFACTURADO)
500 CFM Holley 2V
Use junta de recambio 18-0994



18-7637
CARBURADOR
(REMANUFACTURADO)
600 CFM Holley 4V
(Incluye junta)



18-7638
CARBURADOR
(REMANUFACTURADO)
600 CFM Holley 4V-entrada lateral



18-7640
CARBURADOR
(REMANUFACTURADO)
Universal Q-jet con estrangulador eléctrico
Use junta recambio 18-0462



18-7605-1
CARBURADOR
4 Barrel Rochester
Reemplaza: 382821, 383766, 384194
Remanufacturado
Use junta de recambio 18-2948
Use kit carb de recambio 18-7095



18-7608-1
CARBURADOR
2 Barrel Rochester
Reemplaza: 381668, 980528, 982219, 982217
Remanufacturado
Use junta de recambio 18-0356
Use kit carb de recambio 18-7070



18-80006
CARBURADOR
(Remanufacturado)
Reemplaza: R80382
Para: 5.0, 5.8L, Fi, FL, SX con 2bbl Holley



18-80008
CARBURADOR
(Remanufacturado)
Reemplaza: R7044289
Para: 7.4L con 4 bbl Rochester



18-80009
CARBURADOR
(Remanufacturado)
Reemplaza: R80378
Para: 7.4L Gi, GL, Gsi & 8.2L GL



18-7609-1
CARBURADOR
2 Barrel Rochester
Reemplaza: 382733, 980530, 982217, 984180, 381494, 772831
Remanufacturado
Use junta recambio 18-0356
Use kit carb recambio 18-7070



18-7615-1
CARBURADOR
4 Barrel Rochester
Reemplaza: 981705, 982223, 983855, 981359, 981564, 985822, 981803, 981428
Remanufacturado
Use junta recambio 18-2948
Use kit carb recambio 18-7095



18-7615N
CARBURADOR Q-JET
Reemplaza: 1347-816373A4, 1347-804624R1, 1347-804624R02
(Incluye junta)
Use kit carb recambio 18-7095

APLICACIONES COLAS CARBURADOR OMC

Modelo	Año	OMC Carburador #	MFG Carburador #	Codigo Carb & Modelo	Ref #
80	1968-69	382733, 772831	7028085, 17059053, 17086064, 17087311	R2, 2GC	18-7609-1
90	1970-71	382733, 772831	7028085, 17059053, 17086064, 17087311	R2, 2GC	18-7609-1
120 (400 Series)	1972-86	381668, 980528, 982219	7044186, 17059056	R2, 2GC	18-7608-1
140 (400 Series)	1973-85	979821, 980530, 982217, 984180	17086107	R2, 2GC	18-7608-1
155	1967-72	772831	7026180	R2, 2GC	18-7609-1
165	1972-76	979821, 980530	17086107	R2, 2GC	18-7609-1
185	1989	984180	17086064	R2, 2GC	18-7609-1
200	1966-68	381494	7025187	R2, 2GC	18-7609-1
210	1968-72	382821, 383766	7028282, 7028280	R4, 4MV	18-7605-1
215, 225, 230	1971-76	382821	7028280	R4, 4MV	18-7605-1
230 (800 Series)	1979-89	981705, 982223	17057290, 17059285, 17059286, 17086117	R4, 4MV	18-7615-1
245	1972-75	384194	7040284	R4, 4MV	18-7605-1
250	1970-74	384194	7040284	R4, 4MV	18-7605-1
260 (800 Series)	1975-76	384194	7040284	R4, 4MV	18-7605-1
260 (800 Series)	1979-89	982223	17057290, 17059285, 17059286, 17086117	R4, 4MV	18-7615-1
2.5L, 3.0L	1982-86	982219, 982217	17059056, 17059053	R2, 2GC	18-7608-1
3.0L	1987-90	984180	17086064	R2, 2GC	18-7608-1
3.8L (4V)	1979-85	983855	17082515, 17085010	R4, 4MV	18-7615-1
4.3L (4V)	1979-89	983855	17082515, 17085010	R4, 4MV	18-7615-1
5.0L (GM)(4V)	1979-89	982223	17057290, 17059285, 17059286, 17086117	R4, 4MV	18-7615-1
5.7L (4V)	1979-89	982223	17057290, 17059285, 17059286, 17086117	R4, 4MV	18-7615-1
305, 350 CI, I/B	1977-83	981359, 982215, 981564, 982223	17057290, 17059285, 17059286, 17086117	R4, 4MV	18-7615-1
350 (4V)	1988-89	985822	17057290, 17059285, 17059286, 17086117	R4, 4MV	18-7615-1
454 CI, I/B	1977-78	981803, 981428	17057290, 17059285, 17059286, 17086117	R4, 4MV	18-7615-1



**18-7017
KIT CARBURADOR**
Reemplaza: 985052
235 (5.8L Ford) 1989 7.5L/460 C.I. 1987-89
(Contiene agujas y asientos ajustables)



**18-7018
KIT CARBURADOR**
Reemplaza: 982352
350 C.I. Intraborda 1977-78



**18-7070
KIT CARBURADOR**
Reemplaza: 383615, 982384



**18-7071
KIT CARBURADOR**
Reemplaza: 380186



**18-7072
KIT CARBURADOR**
Reemplaza: 979659, 384743



**18-7080
KIT CARBURADOR**
Reemplaza: 979719



**18-7081
KIT CARBURADOR**
Reemplaza: 982537, 982538,
(Contiene agujas y asientos ajustables)



**18-7086
KIT CARBURADOR**
Reemplaza: 984487

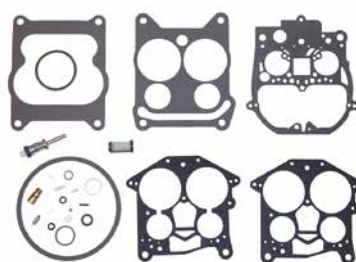

**18-7095
KIT CARBURADOR**
Reemplaza: 983864, 383918



18-7096
KIT CARBURADOR
 Reemplaza: 982539, 85R-4541
 (Contiene agujas y asientos ajustables)



18-7235
KIT CARBURADOR
 Reemplaza: 986783



18-7236
KIT CARBURADOR
 Reemplaza: 986782



18-7237
KIT CARBURADOR
 Reemplaza: 986784, 986799



18-7238
KIT CARBURADOR
 Reemplaza: 986796



18-7239
KIT CARBURADOR
 Reemplaza: 986800



18-7241
KIT CARBURADOR
 Reemplaza: 986804



18-7242
KIT CARBURADOR
 Reemplaza: 987313

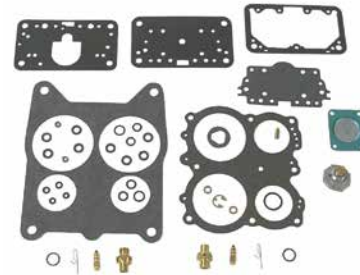

18-7243
KIT CARBURADOR
 Reemplaza: 987315



18-7244
KIT CARBURADOR
 Reemplaza: 987317



18-7245
KIT CARBURADOR
 Reemplaza: 987319



18-7246
KIT CARBURADOR
 Reemplaza: 987438, 987440, 987485



18-7727
KIT CARBURADOR



18-7729
KIT CARBURADOR

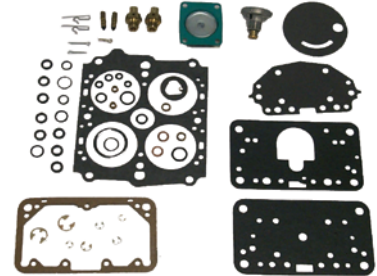

18-7730
KIT CARBURADOR



18-7200
FLOTADOR LATÓN
 (Resistente al alcohol)
 Reemplaza: 381389
 Latón



18-7201
FLOTADOR LATÓN
 (Resistente al alcohol)
 Reemplaza: 383087, 983871
 Latón



18-7206
FLOTADOR NITROPHILO
 Nitrophilo

APLICACIÓN KIT CARBURADOR/FLOTADOR

Modelo	Años	Código Fabricación	Modelo Carburador	Kit Carburador	Flotador
80	1968-69	R2	2GC	18-7070	18-7200
90	1970-71	R2	2GC	18-7070	18-7200
100	1972-73	C1	RBS	18-7080	—
110	1964	R1	BC	18-7071	—
120	1965-71 (Dual Carb)	C1	RBS	18-7080	—
120	1972-85	R2	2GC	18-7070	18-7200
140	1973-85	R2	2GC	18-7070	18-7200
150	1964-65	R1	BC	18-7071	—
150	1965-66	C1	RBC	18-7080	—
155	1967-72	R2	2GC	18-7070	—
165	1972-76	R2	2GC	18-7070	18-7200
170	1974	H2	2300	18-7081	18-7206
175	1975-77	H2	2300	18-7081	18-7206
185	1978-81	R2	2GE	18-7086	18-7200
185	1989	H2	2300	18-7081	18-7206
190	1974-77	H2	2300	18-7081	18-7206
200	1966-68	R2	2GC,V	18-7070	—
200	1979-85	R2	2GE	18-7086	18-7200
200	1989	H2	2300	18-7081	18-7206
210	1968-72	R4	4MV	18-7072	18-7201
215	1971	R4	4MV	18-7072	18-7201
225	1972-76	R4	4MV	18-7072	18-7201
230	1975-76	R4	4MV	18-7072	18-7201
230	1979-89	R4	4MV	18-7095	18-7201
235	1975-77	H4	4160	18-7096	18-7206
235	1989	H4	4160	18-7017	—
240	1978	H4	4160	18-7017	—
245	1972-75	R4	4MV	18-7072	18-7201
250	1970-74	R4	4MV	18-7072	18-7201
250	1979	H4	4160	18-7017	—
260	1975-76	R4	4MV	18-7072	18-7201
260	1979-89	R4	4MV	18-7095	18-7201
290 JET	1974-75	R4	4MV	18-7072	18-7201
2.3L	1987-89	R2	2GE	18-7086	18-7200
2.5L	1982-85	R2	2GC	18-7070	18-7200
2.5L	1986-90	R2	2GE	18-7086	18-7200
2.5L	1986	R2	2GC	18-7070	18-7200
3.0L ⑥	1982-90	R2	2GC	18-7070	18-7200
3.0L/3.0L H.O.	1991-92	H-2	2300	18-7246	N/D
3.8L	1979-85	R2	2GE	18-7086	18-7200
4.3L	1986-89	R2	2GE	18-7086	18-7200
4.3L	1979-89	R4	4MV	18-7095	18-7201
4.3,4.3 H.O. ②	1990-92	H2	2300	18-7238	N/D
4.3,4.3 H.O. ③	1990-92	H4	4160	18-7237	N/D
4.3/262 ②	1989	R2	2GE	18-7086	18-7200
5.0L (GM)	1979-85	R2	2GE	18-7086	18-7200
5.0L (GM)	1979-89	R4	4MV	18-7095	18-7201
5.0L (FORD)	1989	H2	2300	18-7081	18-7206
5.0,5.0 H.O. ③	1989-90	H4	4160	18-7237	N/D
5.0,5.0 H.O. ②	1989-90	H2	2300	18-7236	N/D
5.0,5.0 H.O. ③	1991	H4	4160	18-7245	N/D
5.0,5.0 H.O. ②	1991	H4	4175	18-7244	N/D
5.0,5.0 H.O. ①	1992	H4	4150	18-7242	N/D
5.7L	1979-89	R4	4MV	18-7095	18-7201
5.7	1990-92	H4	4175	18-7239	N/D
5.7 LE ⑨	1991-92	H4	4175	18-7243	N/D
5.7 LE ④	1990	H4	4175	18-7239	N/D
5.8L	1989	H4	4160	18-7017	—
7.5L	1987-88	H4	4160	18-7017	—
305 C.I./B	1977-79	R2	2GE	18-7086	18-7200
305 C.I./B	1977-78	R4	4MV	18-7018	18-7201
305 C.I./B	1979-83	R4	4MV	18-7095	18-7201
350 C.I./B	1977-78	R4	4MV	18-7018	18-7201

② Para carburadores 2V

WS

③ Para carburadores 4V

⑥ Para 1990 PWC Sólo sufijo

④ Para modelo motor 574APEP-

⑨ Para modelo motor 574APERGD

① Para modelo motor 744DPEAMH, 744DPPAMH

② Para modelo motor 744CPEAMH, 824BPEAM

APLICACIÓN KIT CARBURADOR/FOTADOR (Cont.)

Modelo	Años	Código fabricación	Modelo carburador	Kit Carburador	Flotador
350 C.I./B	1979-83	R4	4MV	18-7095	18-7201
350 ④ ③	1988-89	R4	4MV	18-7095	18-7201
350 ②	1988	R2	2GE	18-7086	18-7200
351 CID/5.8L H.O.	—	H4	4010, R50483A, R84046A (F1JL-9510-EA)	18-7727	—
351 CID/5.8L	—	H4	4160, R9393A, R9394A, R50399A, R50399-1A	18-7729	—
351 CID/5.8L	—	H4	4160C, R80434A	18-7730	—
454 C.I./B	1977-78	R4	4MV	18-7072	18-7201
454,454 H.O. ①	1991-92	H4	4150	18-7242	N/D
454,454 H.O. ②	1990-92	H4	4150	18-7241	N/D
460 C.I.	1987-88	H4	4160	18-7017	—
460	1989-90	H4	4160	18-7235	N/D

- ② Para carburadores 2V
- ③ Para carburadores 4V
- ④ Para modelo motor 574APEP-

WS

- ⑥ Para 1990 PWC sólo sufijo

- ⑨ Para modelo motor 574APERGD

- ① Para modelo motor 744DPEAMH, 744DPPAMH

- ② Para modelo motor 744CPEAMH, 824BPEAM

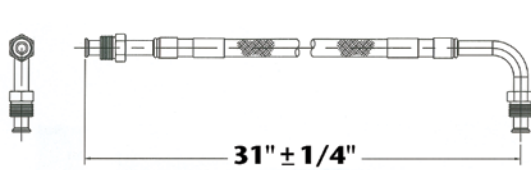

18-8114
LÍNEA COMBUSTIBLE

De la bomba de combustible al carburador. Reemplaza tubo 3/8" X 31" PTFE manguera con hembra 5/8"-18 un final, 5/8"-18 90° un final. SAE J1527 tipo A1

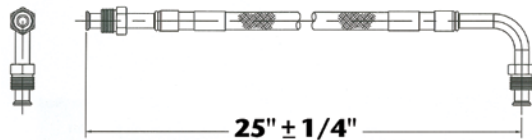

18-8115
LÍNEA COMBUSTIBLE

De la bomba combustible al carburador. Reemplaza tubo 3/8" X 25" PTFE manguera con hembra 5/8"-18 un final, 5/8"-18 90° un final. SAE J1527 tipo A1



18-7229
ANTI-DEFLAGRANTE
Reemplaza: 986865, 981566

TODAS LAS BOMBAS DE COMBUSTIBLE INCLUYEN JUNTA DE MONTAJE



18-7256
BOMBA COMBUSTIBLE
Pestaña I.D. # 6790
Para: GM (4 & 6 cil.)153, 230, 250, 292



18-7265
BOMBA COMBUSTIBLE
Pestaña I.D. # 41412, M73018
Para: GM (V-8) 305, 350, 400



18-7267
BOMBA COMBUSTIBLE
Reemplaza: 982063
Pestaña I.D. # 40778, M73016
(Incluye junta)
Para Ford (V-8) 302



18-7268
BOMBA COMBUSTIBLE
Reemplaza: 981650
Pestaña I.D. #41415
Para: GM (V-8) 305, 307, 350, 400
Se requiere diafragma dual con vaso.



18-7278
BOMBA COMBUSTIBLE
Reemplaza: 985602, 985603, 982240
Pestaña I.D. #M60032
Usar filtro 18-7860
Para: GM (4 & 6 cil.) 153, 181, 250, 224, 225



18-7289
BOMBA COMBUSTIBLE
Reemplaza: 982997
Pestaña I.D. # 60201
(Incluye junta)
Para: GM (V-6) 262/4.36

APLICACIONES EMPIEZAN EN LA SIGUIENTE PÁGINA



18-7326
BOMBA ELÉCTRICA DE COMBUSTIBLE
 Reemplaza: 3858261, 3857986,
 3850809, 3854620



18-7330
BOMBA ELÉCTRICA DE COMBUSTIBLE
 Reemplaza: 3857650, 3855958, 3854280,
 987620, 988037



18-7331
BOMBA ELÉCTRICA DE COMBUSTIBLE
 Reemplaza: 3850810

APLICACIÓN BOMBA COMBUSTIBLE

Modelo	Años	Bomba #	Modelo	Años	Bomba #
2.5	1982-85	18-7278	185	1978-80	18-7268
5	1982-88	18-7268	190	1974-77	—
5.7	1982-92	18-7268	200	1979-81	18-7268
100	1972-73	18-7278	225	1978	18-7268
110	1964	18-7278	230	1979-81	18-7268
120	1965-80	18-7278	235	1975-77	—
140	1973-81	18-7278	240	1978	—
140 Jet Drive	1973	18-7278	245 Jet Drive	1973	18-7278
150	1964	—	250	1979	—
150 Modelo HU-13EM	1965	—	260	1979-81	18-7268
150 Excepto HU-13EM	1965	—	305 CID IB	1979-82	18-7268
165	1972-76	18-7278	350 CID IB	1979-82	18-7268
170	1974	—	350	1988-91	18-7268
175	1975-77	—			

APLICACIÓN BOMBA ELÉCTRICAS DE COMBUSTIBLE

Año	Motor	Aplicación	OE #	Nº referencia reemplaza	Ref #
1992-94	262/4.3L	Baja presión	3858261	3850809,3850810,3857985	18-7326
1997-98	350/5.7L, 454/7.4L, & 502/8.2L	Motores con MPI - Alta presión	3857650		18-7330
1996	454/7.4L & 502/8.2L	Motores con MPI - Alta presión	3857650		18-7330
1993-94	4.3L hasta 5.8L	Bomba de baja presión	3858261	3850809	18-7326
1992-1994	454/7.4L & 502/8.2L	GM Mark V motor. - baja presión	3858714	3850810, 3857985	18-7331

- DISEÑO UNIVERSAL -

SOPORTE FILTRO GASOLINA



Tipo soporte	Ref #	Tipo soporte	Ref #
1/4" Acero inoxidable	18-7777	1/4" Aluminio	18-7853-1
3/8" Acero inoxidable	18-7776	3/8" Aluminio	18-7775

KITS SEPARADOR AGUA/COMBUSTIBLE



KIT DE FILTROS DE 21 MICRONES PARA MOTORES CARBURACIÓN

Tipo de kit	Ref #	Capacidad de filtrado	Contenido
1/4" Aluminio (Filtro corto)	18-7848-1	21	1 - 18-7844 filtro & 1 18-7853-1 soporte 2 - 18-4256 1/4" tapones
1/4" Aluminio bonus pack Contiene filtro de repuesto	18-7848-2	21	2 - 18-7844 filtro & 1 18-7853-1 soporte 2 - 18-4256 1/4" tapones
1/4" Aluminio (Filtro alto)	18-7852-1	21	1 - 18-7845 filtro & 1 18-7853-1 soporte 2 - 18-4256 1/4" tapones
1/4" Aluminio bonus pack Contiene filtro de repuesto	18-7852-2	21	2 - 18-7845 filtro & 1 18-7853-1 soporte 2 - 18-4256 1/4" tapones
3/8" Aluminio (Filtro alto)	18-7775-1	21	1 - 18-7845 filtro & 1 18-7775 soporte 2 - 18-4264 3/8" tapones
1/4" Acero inox (Filtro alto)	18-7777-1	21	1 - 18-7845 filtro & 1 18-7777 soporte 2 - 18-4256 1/4" tapones
3/8" Acero inox (Filtro alto)	18-7776-1	21	1 - 18-7845 filtro & 1 18-7776 soporte 2 - 18-4264 3/8" tapones



KIT FILTROS 10 MICRONES PARA MOTORES DE INYECCIÓN

Kit Tipo	Ref #	Capacidad de filtrado	Contiene
1/4" Aluminio (Filtro alto)	18-7983-1	10	1 - 18-7944 filtro & 1 18-7853-1 soporte 2 - 18-4256 1/4" tapones
1/4" Aluminio bonus pack Contiene filtro de repuesto	18-7983-2	10	2 - 18-7944 filtro & 1 18-7853-1 soporte 2 - 18-4256 1/4" tapones
1/4" Aluminio (Filtro alto)	18-7982-1	10	1 - 18-7945 filtro & 1 18-7853-1 soporte 2 - 18-4256 1/4" tapones
1/4" Aluminio bonus pack Contiene filtro de repuesto	18-7982-2	10	2 - 18-7945 filtro & 1 18-7853-1 soporte 2 - 18-4256 1/4" tapones
1/4" Aluminio (Filtro alta capacidad)	18-7966-1	10	1 - 18-7866 filtro & 1 18-7853-1 soporte 2 - 18-4256 1/4" tapones
3/8" Aluminio (Filtro alto)	18-7986-1	10	1 - 18-7945 filtro & 1 18-7775 soporte 2 - 18-4264 3/8" tapones
1/4" Acero inoxidable (Filtro alto)	18-7984-1	10	1 - 18-7945 filtro & 1 18-7777 soporte 2 - 18-4256 1/4" tapones
3/8" Acero inoxidable (Filtro alto)	18-7985-1	10	1 - 18-7945 filtro & 1 18-7776 soporte 2 - 18-4264 3/8" tapones



KIT FILTROS 10 MICRONES CON VASO DECANTADOR

El vaso transparente Sierra AquaVue™ se usa para fueraborda e instalaciones en cubierta. El vaso metálico AquaVue™ antiinflamable se usa para instalaciones bajo cubierta. Los filtros con vaso decantador transparente o metálico permiten drenar el agua, alargando la vida útil del elemento.

Tipo kit	Ref #	capacidad de filtrado	Contenido
1/4" Aluminio con cazoleta metálica	18-7951	10	1 - 18-7919 filtro & 1 18-7853-1 soporte 1 - 18-7924 cazoleta metálica 2 - 18-4256 1/4" tapones
1/4" Acero inox con cazoleta metálica	18-7938	10	1 - 18-7919 filtro & 1 18-7777 soporte 1 - 18-7924 cazoleta metálica 2 - 18-4256 1/4" tapones

SOPORTE COMPACTO Y KIT SEPARADOR- PARA PEQUEÑOS INTRABORDA Y FUERABORDA Y APLICACIONES EN AGUA DULCE

18-7774
SOPORTE ALUMINIO COMPACTO



18-7965-1
10 MICRONES COMPACTOS
KIT SEPARADOR
Contiene:
1 - 18-7774 soporte
1 - 18-7865 filtro



FILTROS DE REPUESTO



DISEÑO UNIVERSAL

FILTROS DE REPUESTO 10 MICRONES

Ref #	Descripción
18-7944	Corto - 3.875"
18-7945	Largo - 4.35"
18-7866	Alta capacidad - 6"
18-7865	10 micrones compacto

FILTROS DE REPUESTO 21 MICRONES

Ref #	Descripción
18-7844	Corto- 3.875"
18-7845	Largo - 4.35"

FILTROS DE REPUESTO PARA OMC

FILTROS DE REPUESTO 10 MICRONES

Ref #	Descripción	Reemplaza
18-7946	Rosca OMC	OMC 502905
18-7989	Cobra EFI	OMC 502906

FILTROS DE REPUESTO 21 MICRONES

Ref #	Descripción	Reemplaza
18-7846	Rosca OMC	OMC 502905
18-7789	Cobra EFI	OMC 502906



FILTROS DE REPUESTO 10 MICRONES Y CON VASO DECANTADOR

Ref #	Descripción	Reemplaza
18-7919	Elemento filtrante	Racor S3213
18-7920	Elemento filtrante	OMC 771839 Racor S3214
18-7947	Elemento filtrante Para - 120RRAC01	Racor S3240
18-7948	Elemento filtrante Para - 320RRAC01	Racor S3227
18-7949	Spin on replacement Para - 660RRAC02	Racor S3232

Ref #	Descripción
18-7929	Filtro & Cazoleta metálica Contiene: 18-7919 filtro, 18-7924 cazoleta
18-7941-1	Filtro & AquaVue™ cazoleta estilo OMC Contiene: 18-7920 filtro, 18-7922-1 cazoleta
18-7943	Filtro & vaso metálico estilo OMC Contiene: 18-7920 filtro, 18-7924 cazoleta

Ref #	Descripción
18-7924	Vaso metálico

Ref #	Descripción	Reemplaza
18-7930	1977-83 Sistema combustible	OMC 173326



18-7792
FILTRO COMBUSTIBLE
Reemplaza: 910641, 3855104
Para: OMC 3.0L (1996-98), 3.8L/170 (1981)



18-7854
FILTRO COMBUSTIBLE
Reemplaza: 984491, 311684
Rochester 17078904



18-7855
FILTRO COMBUSTIBLE
Reemplaza: 983870, 910139
Rochester 17068453



18-7717
FILTRO ELEMENTO
Para: Rochester 2 cuerpos & 4 cuerpos Carb.



18-7859
FILTRO COMBUSTIBLE
Reemplaza: 908034
Para: mayoría de GM Inline 4 & 6 cilindros en línea: Ford y GM V-8's hasta 400 HP



18-7860
FILTRO COMBUSTIBLE
Reemplaza: 381690, 312456
Con bomba combustible AC
Para: motores 4 & 6 cilindros en línea



18-7861
RECAMBIO DE CESTO Y FILTRO
Reemplaza: 981911



18-7862
RECAMBIO
Para filtro combustible
(Incluye junta)
Reemplaza: 982230



18-7964
KIT FILTRO TRANSMISIÓN



18-8072
CODO DEPÓSITO
3/8" Manguera con rosca
3/8" Rosca NPT
Reemplaza: 174177
90°

Display Package



RACOR
Rosca NPT
18-8074 **18-8055**
3/8" con 1/4" 5/16" con 1/4"
Reemplaza: 173312 Reemplaza: 173311

Display Package

Pack de 10

ABRAZADERAS

Ref.	O.E.	Rango	tam
18-8020 ①	322652	.538 - .608	8
18-8021 ①	911616	.597 - .665	10
18-8034 ①	329654	.670 - .780	12
18-8200 ①	322653	.360 - .406	2
18-8201 ①	124249	.410 - .468	4
18-8202 ①	322654	.475 - .536	6
18-8203 ①	329653	.750 - .875	14
18-8204 ①	324825	.875 - .975	19



18-5894
INTERRUPTOR PRESIÓN ACEITE
Reemplaza: 0379948

NEW

APLICACIÓN BOMBAS CIRCULACIÓN AGUA



18-3575
BOMBA DE CIRCULACIÓN AGUA
Reemplaza: 984360, 986779, 380640, 3854017
Usar junta 18-0327 (Incluye)
Para: GM En línea (4 & 6 Cilindros)



18-3577-1
BOMBA DE CIRCULACIÓN AGUA
Reemplaza: GM 6269358, OMC 987447, 983296, 986074, 3854118
Para: Bloque grande GM



18-3584
BOMBA DE CIRCULACIÓN AGUA
Reemplaza: 982517, 3853796, 982515
Usar junta 18-0147 (Incluye)
Para: Ford V8 bloque pequeño



18-3599-1
BOMBA DE CIRCULACIÓN AGUA
Reemplaza: 382218, 980477, 985429, 3853850
Para: GM V-6 & bloques pequeños motor V-8
Usar junta 18-0981 (incluye)

① Precio por pieza. Para pedir precio por pack, añadir -9 a la referencia.

APLICACIÓN BOMBA CIRCULACIÓN AGUA

Modelo	Año	Ref #	Modelo	Año	Ref #	Modelo	Año	Ref #
2.3	1987-90	-	165	1972-76	18-3575	245	1972-75	18-3599-1
2.5	1982-86	18-3575	175	1977	18-3584	245		
3	1982-92	18-3575	185	1967-80	18-3599-1	Jet Drive	1972-75	18-3599-1
3.8	1981-86	18-3599-1	190	1977	18-3584	250		
4.3	1985-92	18-3599-1	200	1979-81	18-3599-1	Intraborda	1970-74	18-3599-1
5	1982-88	18-3599-1	210	1968-70	18-3599-1	250	1979	18-3575
5	1989-92	18-3575	210			260		
5.7	1982-92	18-3599-1	Intraborda	1970-72	18-3599-1	Intraborda	1975-76	18-3599-1
5.8	1989-92	18-3575	215	1971	18-3599-1	260	1979-81	18-3599-1
100	1972	18-3575	225	1972-78	18-3599-1	262	1989	18-3599-1
100	1973	18-3599-1	225			290		
120	1965-69	18-3575	Intraborda	1973-74	18-3599-1	Jet Drive	1974-75	18-3599-1
120	1972	18-3575	230			305 CID IB	1977-82	18-3599-1
120	1973-74	18-3599-1	Intraborda	1975-76	18-3599-1	350 CID IB	1977-82	18-3599-1
120	1975-81	18-3575	230	1979-81	18-3599-1	350	1988-92	18-3599-1
140			235	1971	18-3599-1	351	1992	18-3584
Jet Drive	1973	18-3575	235	1977	18-3584	454 CID IB	1977-80	18-3577-1
140	1973-81	18-3575	240	1978	18-3584	454 CID IB	1982	18-3599-1

**18-3058
IMPULSOR**
Reemplaza: 983895



**18-3086
IMPULSOR**
Reemplaza: 379475, 777130



**18-30585
IMPULSOR**
Reemplaza: 3854072
Para: King Cobra (1992-1995)



APLICACIÓN IMPULSORES

Modelo	Años	Impulsor	Modelo	Años	Impulsor
2.3	1987-1990	18-3058 ①	170	1974	18-3086
2.5	1986	18-3058	175	1975-1977	18-3086
3	1986-1992	18-3058 ①	185	1967-1968	18-3086
4.3	1986-1992	18-3058	185	1978-1984	18-3086
5	1986-1992	18-3058	190	1974-1977	18-3086
5.7	1986-1992	18-3058 ②	200	1966-1968	18-3086
5.8	1989-1992	18-3058	200	1979-1984	18-3086
50FAPLJVB, 50FAPJVN	1993	18-3058	210	1968-1972	18-3086
50FAPRJVB	1993	18-3058	215	1971	18-3086
50FACPMDA, 50FACPMDM	1994	18-3060	225	1972-1976	18-3086
50FAGPMDA, 50FAGPMDM	1994	18-3060	225	1978	18-3086
50FAGPMDM	1994	18-3060	230	1975-1976	18-3086
58FACPMDA, 58FACPMDM	1994	18-3060	230	1979-1981	18-3086
58FAGPMDA, 58FAGPMDM	1994	18-3060	232AMFTC	1987	18-3086
58FAPLJVB, 58FAPLJVN	1993	18-3058	232AMRGDE, 232AMRGDP	1988	18-3058
58FAPRJVB, 58APRJVN	1993	18-3058	232APFTC	1987	18-3058
7.5	1987	18-3058	232APRGDE, 232APRGDP	1988	18-3058
80	1968-1969	—	232APSRC	1987	18-3058
88	1964	—	232BMRMED, 232BMRMEF	1989	18-3058
90	1965-1968	—	232BPRMED, 232BPRMEF	1989	18-3058
90	1970-1971	—	235	1971	18-3088
100	1972-1973	18-3086	235	1975-1977	18-3088
110	1964	— ③	240	1978	18-3088
110	1964	18-3086 ④	245	1972-1975	18-3086
120	1965-1967	— ③	250	1970-1974	18-3086
120	1965-1967	18-3086 ④	250	1979	18-3086
120	1968-1984	18-3086	252AMKWB, 252APKWB	1986	18-3058
140	1973-1984	18-3086	260	1975-1976	18-3086
150	1964-1966	18-3086	260	1979-1984	18-3086
155	1967-1972	18-3086	262	1989	18-3058
165	1972-1976	18-3086	262AMLMED, 262APRMED	1989	18-3058

① Excepto modelos originalmente equipados con impulsor corto o re-equipados con kit impulsor corto

② Excepto modelos 1992 5.7LE ③ Bomba estándar ④ Bomba Heavy duty

Modelo	Años	Impulsor	Modelo	Años	Impulsor
302AMARJ, 302AMARY	1987	18-3058	434AMKWB	1986	18-3058
302AMFTC	1987	18-3058	434AMPLPWS	1990	18-3058
302AMKWB	1986	18-3058	434AMWXS	1986	18-3058
302AMRGDP	1988	18-3058	434AMLGDP	1988	18-3058
302AMRMED	1989	18-3058	434APARY, 434APFTC	1987	18-3058
302APARY, 302APFTC	1987	18-3058	434APKWB	1986	18-3058
302APKWB	1986	18-3058	434APLAMH	1992	18-3058
302APRGDP	1988	18-3058	434APLJVB, 434APLJVN	1993	18-3058
302APRMED	1989	18-3058	434APLRGD	1991	18-3058
302APSRC, 302ARSRY	1987	18-3058	434APRAMH	1992	18-3058
302BMRAMH, 302BMRAMK	1992	18-3058	434APRGDP	1988	18-3058
302BMRJVB	1993	18-3058	434APRJVB, 434APRJVN	1993	18-3058
302BMRRGD	1991	18-3058	434APRPWS	1990	18-3058
302CCPMDA, 302CGPMDA	1994	18-3060	434APRRGD	1991	18-3058
302CMHUB	1995	18-3060	434APSRC, 434APSRV	1987	18-3058
302CMNCA, 302CMNCS	1996	18-3060	434APWXS	1986	18-3058
302CMRAMH, 302CMRRAMK	1992	18-3058	454	1977	18-3086
302CMRJVB	1993	18-3058	454	1990-1991	18-3058
302CMRRGD	1991	18-3058	460	1988-1990	18-3058
302CPHUB	1995	18-3060	460AMLMED	1989	18-3058
302CPNCA "A" SUFFIX MODELS	1996	18-3060	460APRMED	1989	18-3058
302CPNCS "A" SUFFIX MODELS	1996	18-3060	502ACPMDA	1994	18-3060
302CPRAMH, 302CPRAMK	1992	18-3058	502AGPMDA	1994	18-3060
302CPRJVB	1993	18-3058	502AMLGDP	1988	18-3058
302CPRRGD	1991	18-3058	502AMLMED	1989	18-3058
302DCMMDA, 302DGMMDA	1994	18-3060	502AMPLPWS, 502ANLPWS	1990	18-3058
305	1977-1978	18-3086	502APLAMH, 502APLAMK	1992	18-3058
350	1977-1978	18-3086	502APLJVB	1993	18-3058
350	1988-1991	18-3058	502APLRGD	1991	18-3058
350AMLMED, 350APRMED	1989	18-3058	502APRAMH, 502APRAMK	1992	18-3058
370	1988	18-3058	502APRGDP	1988	18-3058
432ACMMDA, 432ACPMDA	1994	18-3060	502APRJVB	1993	18-3058
432AGMMDA, 432AGPMDA	1994	18-3060	502APRMED	1989	18-3058
432AMARY, 432AMFTC	1987	18-3058	502APRPWS	1990	18-3058
432AMKWB	1986	18-3058	502APRRGD	1991	18-3058
432AMLGDP	1988	18-3058	502BPRAMH, 502BPRAMK	1992	18-3058
432AMLMED	1989	18-3058	502BPRJVB	1993	18-3058
432AMPLPWS	1990	18-3058	502BPRMED	1989	18-3058
432AMWXS	1986	18-3058	502BPRPWS	1990	18-3058
432APARY, 432APFTC	1987	18-3058	502BPRRGD	1991	18-3058
432APKWB	1986	18-3058	504AMARY, 504AMFTC	1987	18-3058
432APLAMH	1992	18-3058	504AMKWB	1986	18-3058
432APLJVB, 432APLJVN	1993	18-3058	504AMLGDP	1988	18-3058
432APLRGD	1991	18-3058	504AMWXS	1986	18-3058
432APRAMH	1992	18-3058	504APARY, 504APFTC	1987	18-3058
432APRGDE, 432APRGDP	1988	18-3058	504APKWB	1986	18-3058
432APRJVB, 432APRJVN	1993	18-3058	504APRGDP	1988	18-3058
432APRMED	1989	18-3058	504APWXS	1986	18-3058
432APRPWS	1990	18-3058	572ACPMDA, 572AGPMDA	1994	18-3060
432APRRGD	1991	18-3058	574AMFTC	1987	18-3058
432APSRC, 432APSRV	1987	18-3058	574AMKWB	1986	18-3058
432APWXS	1986	18-3058	574AMLGDP	1988	18-3058
434AMARY, 434AMFTC	1987	18-3058	574AMLMED	1989	18-3058

① Excepto modelos originalmente equipados con impulsor corto o re-equipados con kit impulsor corto

② Excepto modelos 1992 5.7LE ③ Bomba estándar ④ Bomba Heavy duty

Modelo	Años	Impulsor	Modelo	Años	Impulsor
574AML PWS	1990	18-3058	584AML MED	1989	18-3058
574AMWXS	1986	18-3058	584AML PWS	1990	18-3058
574APARY	1987	18-3058	584APL AMH, 584APL AMK	1992	18-3058
574APEPWS	1990	18-3058	584APL JVB	1993	18-3058
574APERGD	1991	18-3058	584APL RGD	1991	18-3058
574APFTC	1987	18-3058	584APR AMH, 584APR AMK	1992	18-3058
574APKWB	1986	18-3058	584APR JVB	1993	18-3058
574APL AMH	1992	18-3058	584APR MED	1989	18-3058
574APL RGD	1991	18-3058	584APR PWS	1990	18-3058
574APR AMH	1992	18-3058	584APR RGD	1991	18-3058
574APR GDP	1988	18-3058	744APEPWS	1990	18-3058
574APR MED	1989	18-3058	744APERGD, 744APERGF	1991	18-3058
574APR PWS	1990	18-3058	744BPERGD	1991	18-3058
574APR RGD	1991	18-3058	754APEPWS	1990	18-3058
574AP SRC	1987	18-3058	754APFTC, 754AP SRC	1987	18-3058
574APWXS	1986	18-3058	754BPFTC, 754BP SRC	1987	18-3058
574BML GDP	1988	18-3058	① Excepto modelos originalmente equipados con impulsor corto o re-equipados con kit impulsor corto ② Excepto modelos 1992 5.7LE models ③ Bomba estándar ④ Bomba Heavy duty		
574BPEPWS	1990	18-3058			
574BPERGD	1991	18-3058			
574BPR GDP	1988	18-3058			
584ACPMDA, 584AGPMDA	1994	18-3060			



18-3108
LLAVE IMPULSOR
 Reemplaza: 308928
 Para: Modelo colas (1968-85)
 Para: Impulsores stringer drive 18-3086



18-3111
RETÉN EJE BOMBA AGUA
 Reemplaza: 907774
 I/O 1972-86
EXCEPTO COBRA



18-4833
ALOJAMIENTO PASO DE AGUA (UNIDAD INFERIOR)
 Reemplaza: 915720
 Para: OMC Cobra (1986-93) Sin cono de embrague



18-4837
TAPA PASO DE AGUA
 Reemplaza: 911734
 Para: OMC Cobra (1986-93) sin cono de embrague



18-3119
ALOJAMIENTO BOMBA AGUA
 Reemplaza: 983298



18-3206
ALOJAMIENTO BOMBA AGUA
 Reemplaza: 984744
 Para: OMC Cobra



18-3145
CASQUILLO TURBINA
 Reemplaza: 911844



18-3121
PLATINA IMPULSOR
 Reemplaza: 911703
COBRA



18-3141
PLATINA IMPULSOR
 Reemplaza: 313176
 110-260 HP I/O 1968-86
EXCEPTO COBRA



18-3502
MANGUERA BOMBA
 Reemplaza: 912614
 Para: OMC Cobra (1986-93) sin cono de embrague

① 18-3212-1D Display Package



**18-3212-1
KIT REPARACIÓN IMPULSOR**
Reemplaza: 984461

— CONTIENE —

Ref #	Descripción	O.E.M. #	Cant.
18-2541	Aro tórico	911704	1
18-2916	Junta aloj. bomba agua	911702	1
18-3058	Impulsor	983895	1
18-3121	Platina impulsor	911703	1
18-3145	Casquillo impulsor	911844	1



**18-3286
KIT REPARACIÓN IMPULSOR**
1964-86
EXCEPTO COBRA

— CONTIENE —

Ref #	Descripción	O.E.M. #	Cant.
18-7135	Aro tórico	310584	1
18-3141	Platina	313176	1
18-7129	Aro tórico	314491	1
18-3111	Retén goma	907774	1
18-3086	Impulsor	379475	1
18-7158	Aro tórico	310585, 310967	1



**18-3386
KIT BOMBA AGUA**
Reemplaza: 983218
1964-86
EXCEPTO COBRA

— CONTIENE —

Ref #	Descripción	O.E.M. #	Cant.
18-7135	Aro tórico	310584	1
18-3141	Platina	313176	1
18-7129	Aro tórico	314491	1
18-3086	Impulsor	379475	1
18-3111	Retén goma	907774	1
18-3119	Alojamiento Impulsor	983298	1
18-7158	Aro tórico	310585, 310967	1



**18-3348
KIT COMPLETO BOMBA AGUA**
Reemplaza: 984461
Para: Todas colas OMC Cobra-2.3 (1987-90), 2.5 (1986), 3.0(1986-93), 4.3(1986-93), 4.6(1989), 5.0(1986-93), 5.7(1986-93), 5.8 (1989-93), 7.5(1987-89)
Usar impulsor 18-3058



**18-3469
KIT REPARACIÓN BOMBA AGUA**
Reemplaza: 3854661
Para: Colas King Cobra (1992-1995)



**18-3349
KIT ALOJAMIENTO BOMBA AGUA**
Para: Todas colas OMC Cobra-2.3 (1987-90), 2.5 (1986), 3.0(1986-93), 4.3(1986-93), 4.6(1989), 5.0(1986-93), 5.7(1986-93), 5.8 (1989-93), 7.5(1987-89)



**18-5897
TRANSMISOR DE TEMPERATURA**
Reemplaza: 980613
3/8" — 18 NPT
Para: Mercruiser Vazer



**18-5898
TRANSMISOR DE TEMPERATURA**
Reemplaza: 171960
1/2" — 14 NPT



**18-5899
TRANSMISOR PRESIÓN ACEITE**
Reemplaza: 982650



**18-3554
TERMOSTATO**
Reemplaza: 383307
160°



**18-3558
TERMOSTATO**
Reemplaza: 982554, 3853799
160°

① 18-3653D Display Package



**18-3653
KIT TERMOSTATO**

— CONTIENE —

Ref #	O.E. #	Desc.
18-3554	383307	Termostato
18-2858	314809	Junta colector
18-2917	3701777 (GM)	Junta termostato
18-0398	3852111	Junta termostato

APLICACIÓN PARA TERMOSTATOS/KITS EN LA SIGUIENTE PÁGINA

① Referencias acabadas en "D" envasadas - Referencia normal no envasada



① 18-3670D



**18-3670
KIT TERMOSTATO**

Para: 2.5L & 3.0L (1982-88)

— CONTIENE —

Ref #	O.E.#	Desc.
18-3558	982554	Termostato
18-2858	314809	Junta tapa aloj.termostato
18-0929	313416	Junta termostato



① 18-3676D



**18-3676
KIT TERMOSTATO**

140°

Para: 7.4L (1994-98), 8.2L (1998)

— CONTIENE —

Ref #	O.E.#	Desc.
18-7170	3852071	Aro
18-0398	3852111	Junta termostato
—	3853983	Termostato



① 18-3677D



**18-3677
KIT TERMOSTATO**
160°

— CONTIENE —

Ref #	O.E.#	Desc.
18-7170	3852071	Aro
18-0398	3852111	Junta termostato
—	3856961	Termostato

HP	Año	HP	Año
4.3L	1994-97	5.8L	1994-97
4.3 HO	1991-97	5.8 (EFI)	1993-97
5.0 L	1994-97		

APLICACIONES TERMOSTATO/KIT TERMOSTATO

Modelo	Años	Termostato	Kit Termostato	Modelo	Años	Termostato	Kit Termostato
90	1970	18-3554	18-3653	250	1970-73	18-3554	18-3653
100	1972-73	18-3554	18-3653	250	1979	18-3554	18-3653
120	1969-80	18-3554	18-3653 ①	260	1979-81	18-3554	18-3653
120	1980-81	18-3558	18-3670 ②	262	1989	18-3554	—
140	1973-80	18-3554	18-3653 ①	305	1977-82	18-3554	18-3653
140	1980-81	18-3558	18-3670 ②	350	1977-82	18-3554	18-3653
155	1969-72	18-3554	18-3653	350	1989	18-3554	—
165	1972-76	18-3554	18-3653	351	1992	18-3554	—
170	1974	18-3554	18-3653	454	1977-82	18-3554	18-3653
175	1975-77	18-3554	18-3653	460	1989	18-3554	—
185	1978-80	18-3554	18-3653	2.5L	1982-88	18-3558	18-3670
190	1974-77	18-3554	18-3653	3.0L	1982-88	18-3558	18-3670
200	1979-81	18-3554	18-3653	3.8L	1981-85	18-3554	18-3653
210	1969-72	18-3554	18-3653	4.3L	1985-86	18-3554	18-3653
215	1971	18-3554	18-3653	4.3L	1989-92	18-3554	—
225	1971	18-3554	18-3653	5.0L	1982-88	18-3554	18-3653
230	1979-81	18-3554	18-3653	5.0L	1989-92	18-3554	—
235	1971	18-3554	18-3653	5.7L	1982-88	18-3554	18-3653
235	1975-77	18-3554	18-3653	5.7L	1989	18-3554	—
240	1978	18-3554	18-3653	5.8L	1989-92	18-3554	—
245	1972-75	18-3554	18-3653	7.5L	1988	18-3554	18-3653

① 1980 Modelos con solo sufijo "C"

② 1980 Modelos con sufijo "C1"

MANGUITOS DIÁMETRO ÚNICO

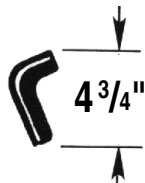

18-70021
MANGUITO
3/4" DI



18-70704
MANGUITO
1 1/4" DI



18-70924
MANGUITO
1 3/4" DI

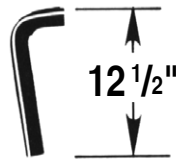

18-71218
MANGUITO
1" DI

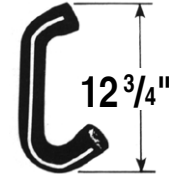

18-71337
MANGUITO
1 3/4" DI

MANGUITOS RECTOS



18-75100
MANGUITO
Longitud 48"
1" DI



18-75125
MANGUITO
Longitud 48"
1 1/4" DI

① Referencias acabadas en "D" envasadas - Referencia normal no envasada

CORREAS

- 1 Cordón sintético de alta resistencia. Sus propiedades aseguran un comportamiento uniforme de toda la correa.
- 2 La sección de compresión es un compuesto de goma que garantiza la suavidad de los impactos que reciben los cordones.
- 3 Dientes moldeados para incrementar la flexibilidad sin dañar el soporte. Gran área de circulación de aire evita el calentamiento y deterioro de la correa.
- 4 Los bordes de goma mantienen una transmisión de energía muy fiable.

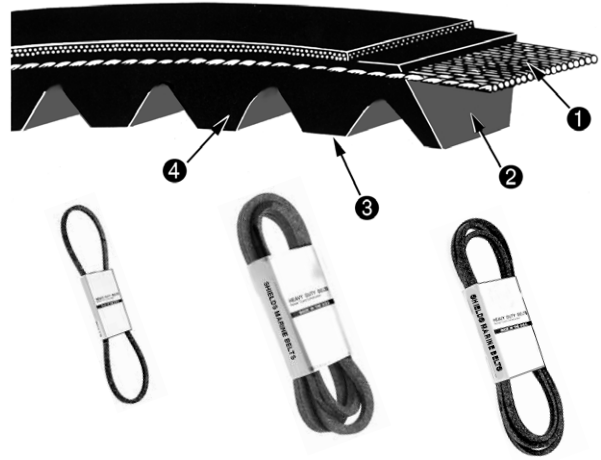

TAMAÑOS DE CORREAS ORDENADAS POR NÚMERO

Ref #	Longitud efectiva (Pulgadas)	Ancho máximo (Pulgadas)	Ref #	Longitud efectiva (Pulgadas)	Ancho máximo (Pulgadas)	Ref #	Longitud efectiva (Pulgadas)	Ancho máximo (Pulgadas)
18-15290	29	29/64	18-15405	40 1/2	29/64	18-15460	46	29/64
18-15300	30	29/64	18-15410	41	29/64	18-15470	47	29/64
18-15325	32 1/2	29/64	18-15415	41 1/2	29/64	18-15480	48	29/64
18-15345	34 1/2	29/64	18-15430	43	29/64	18-15495	49 1/2	29/64
18-15370	37	29/64	18-15435	43 1/2	29/64	18-15500	50	29/64
18-15380	38	29/64	18-15440	44	29/64	18-15520	52	29/64
18-15390	39	29/64	18-15450	45	29/64	18-15550	55	29/64
18-15400	40	29/64	18-15455	45 1/2	29/64			

CORREAS INTERCAMBIO

INTERCAMBIO MANGUITOS

OMC #	Ref #	Ref #	OMC #	Sierra #	Ref #	Sierra #	Ref #
310953	18-15460	18-15380	910414	18-71337	312781	18-75100	913488
311046	18-15440	18-15400	311606	18-75100	910305	18-75125	912793
311606	18-15400	18-15415	910343	18-75100	912424		
908929	18-15455	18-15435	912509				
909818	18-15500	18-15440	311046				
909971	18-15460	18-15450	914787				
910343	18-15415	18-15455	908929				
910414	18-15380	18-15460	310953				
912418	18-15500	18-15460	909971				
912509	18-15435	18-15500	909818				
912714	18-15520	18-15500	912418				
914787	18-15450	18-15520	912714				

APLICACIÓN CORREAS

Modelo	Año	Alternador	Bomba agua	Dirección Asistida	Modelo	Año	Alternador	Bomba agua	Dirección Asistida
100	1972-73	18-15400	18-15400	—	262 KING COBRA	1989	—	*18-15380	18-15455
110	Todos	18-15440	18-15440	—	305	1977-84	18-15440	18-15440/ *18-15455 or *18-15500	—
120	1965-81	18-15400	18-15400	—	350	1977-84	18-15440	18-15440/ *18-15455 or *18-15500	—
140	1982-87	18-15400	18-15400	—	350 KING COBRA	1988-90	18-15455	18-15455	—
165	1972-76	18-15400	18-15400	—	350 KING COBRA	1988-90	18-15470	*18-15380	18-15455
170	1974	18-15400	18-15400	—	454	1977-82	18-15455	18-15455/ *18-15500	—
175	1975-77	18-15400	18-15400	—	454 KING COBRA	—	—	18-15470	18-15380
185 sin PS	1978-84	18-15440	18-15440	—	460 KING COBRA	1988	18-15460	18-15460	18-15520
185 con PS	1978-84	18-15460	18-15460	18-15460	888	—	18-15435	18-15435	—
190	1974-77	18-15400	18-15400	—	2.3L	1987-90	18-15435	18-15435	18-15435
200 sin PS	1979-81	18-15440	18-15440	—	2.5L sin PS	1982-87	18-15415	18-15415	—
200 con PS	1979-81	18-15460	18-15460	18-15460	2.5L con PS	1982-87	18-15400	18-15400	18-15460
210	1970-71	18-15440	18-15440	—	3.8L sin PS	1982-90	18-15400	18-15400	—
215	1971	18-15440	18-15440	—	3.8L con PS	1982-90	—	*18-15380	18-15455
225	1972-84	18-15440	18-15440	—	5.0L sin PS	1982-90	18-15455	18-15455	—
230,260	1975	18-15440	18-15440/ *18-15455	—	5.0L con PS	1982-90	—	*18-15380	18-15455
230,260	1979-81	18-15440	18-15440	—	7.5L	1987	18-15460	18-15460	18-15520
230,260	1979-81	18-15460	18-15460	18-15460					
235	1971	18-15440	18-15440	—					
235	1975-77	18-15400	18-15400	—					
240	1978-84	18-15400	18-15400	—					
250	1979	18-15400	18-15400	—					
262 KING COBRA	1989	18-15400	18-15400	—					

* CON BOMBA AGUA MARINA

Fits GM 181 CID 3.0L, 4 Cylinder

Fits Most 141 Models

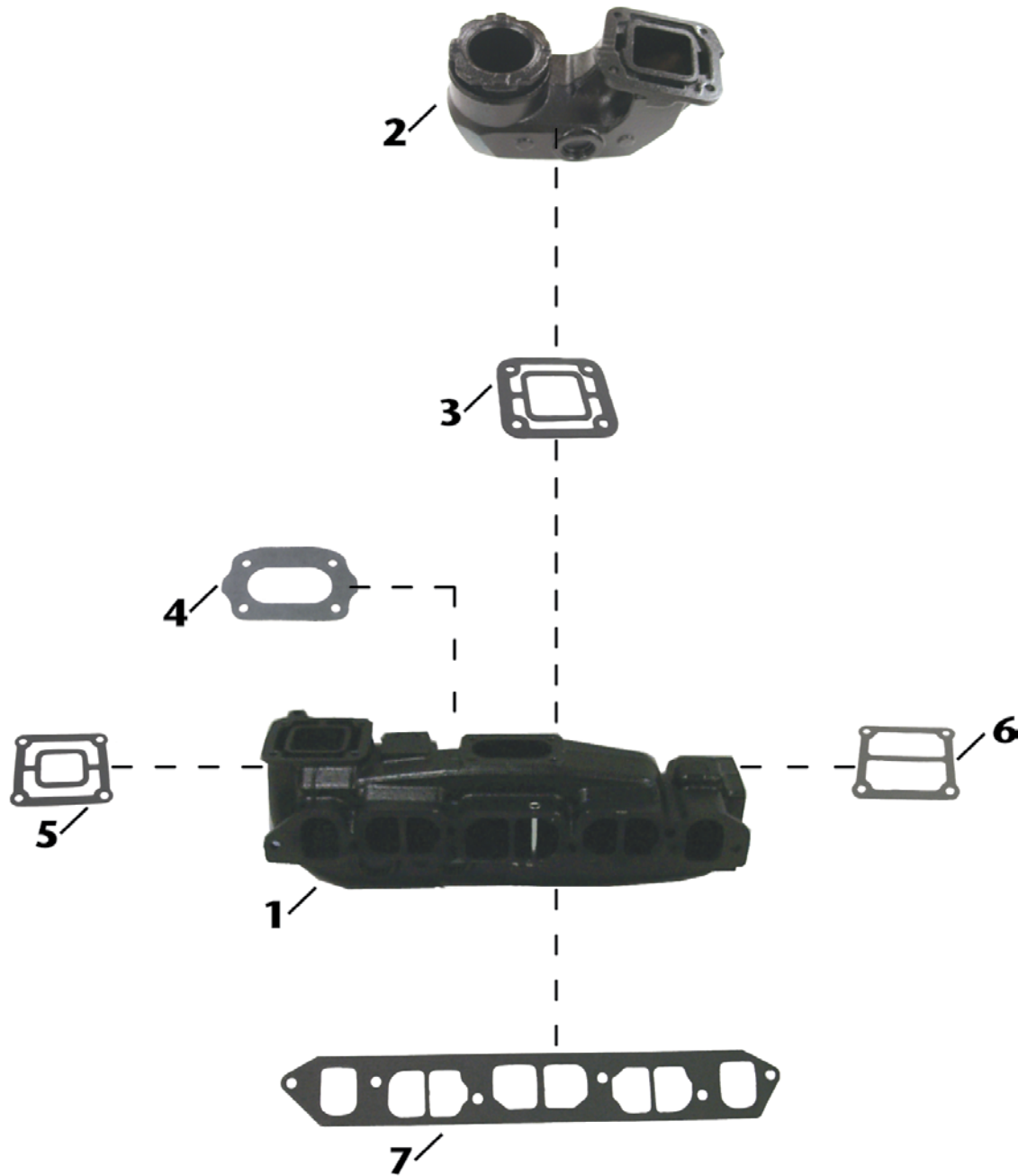

Ref	Descripción	OE No.	Aplicación	
1	18-1901	COLECTOR	982490, 980083, 984054	GM 181 cu.in. 3.0L , 4 Cilindro. Para modelos 140.
2	18-1922	CODO COLECTOR	987784	Usar con colector: 18-1901; Junta codo: 18-2875-1
3	18-2875-1	JUNTA CODO	3850495	Usar con codo: 18-1922
4	18-0937	JUNTA CARBURADOR	315055	Usar con colector: 18-1901
5	18-2861-1	JUNTA TAPA	311121	Usar con colector: 18-1901
6	18-0114	JUNTA TAPA LATERAL	907761	Usar con colector: 18-1901
7	18-1204-1	JUNTA COLECTOR	912164	Usar con colector: 18-1901

Fits GM Small Block V8 305-350 cu. in. 1979-1989

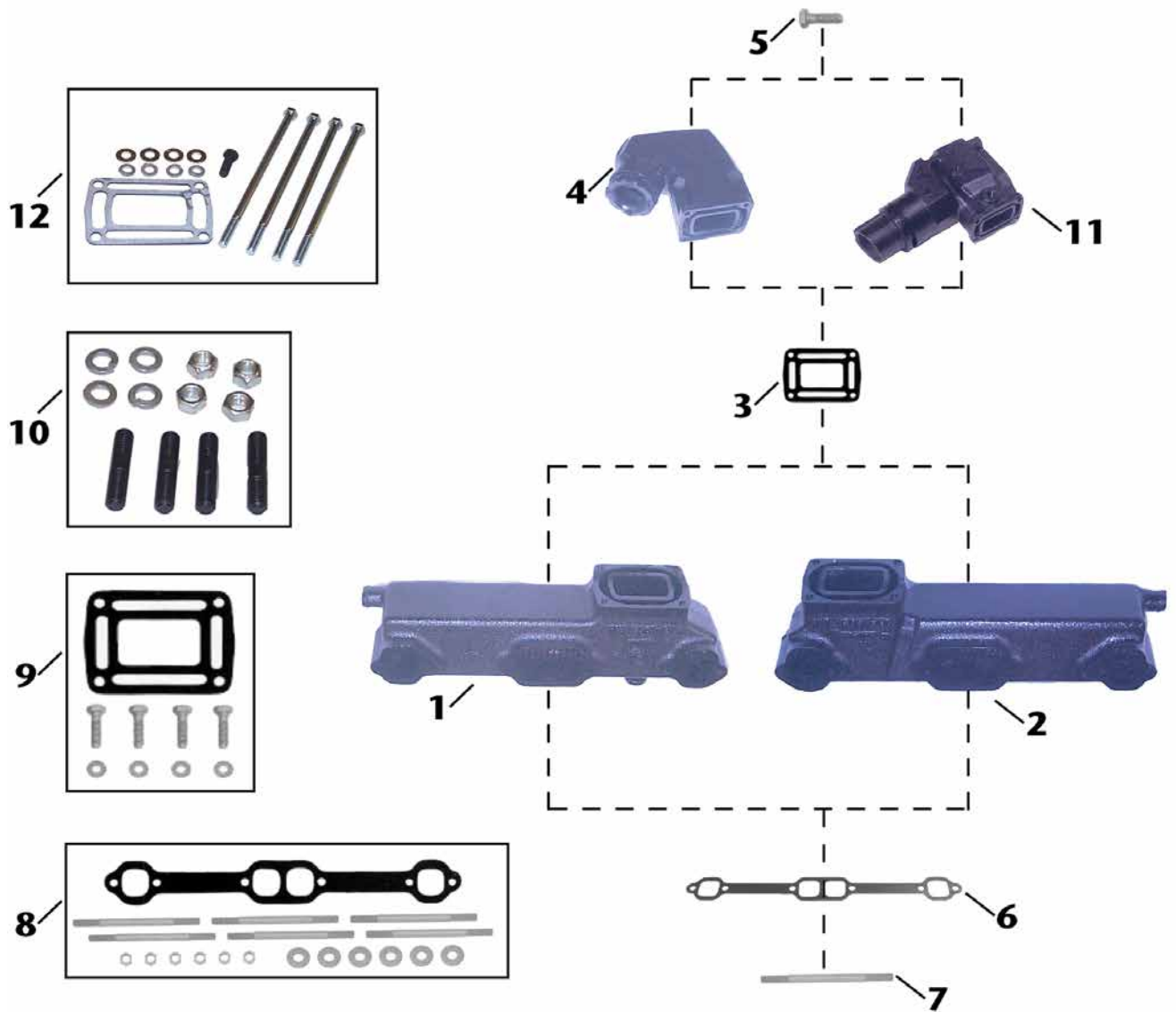

Ref	Descripción	OE No.	Aplicación	
1	18-1902	COLECTOR (ESTRIBOR)	912441	GM Bloque pequeño (V8) 305-350 cu.in. (1979-1989)(Estribor) Usar con junta colector: 18-2949. Kit montaje: 18-8502
2	18-1903	COLECTOR (BABOR)	912442	GM Bloque pequeño (V8) 305-350 cu.in. (1979-1989)(Babor). Usar con junta colector: 18-2949. Kit de montaje: 18-8502
3	—	JUNTA CODO	909786	Usar con codo: 18-1921; Kit de montaje: 18-8534.
4	18-1921	CODO COLECTOR	909863	Usar con colector: 18-1902, 18-1903. Kit montaje: 18-8534.
5	NSI	PERNO DE MONTAJE	N/D	Incluido en Kit de montaje 18-8534.
6	18-2949	JUNTA COLECTOR	96306	Usar con colector: 18-1902, 18-1903. Incluye en 18-8502 Kit montaje.
7	NSS	ESPARRAGOS DE MONTAJE	N/D	Incluido en el kit de montaje 18-8502.
8	18-8502	KIT DE MONTAJE	N/D	Usar con colector: 18-1902, 18-1903. Incluye junta colector 18-2949.
9	18-8534	KIT DE MONTAJE	N/D	Usar con codo: 18-1921.
10	18-8553	KIT TORNILLERÍA	N/D	Tornillería sólo para codo 18-1921.
11	18-1909-1	CODO COLECTOR	N/D	Usar con junta codo: 18-0943-2
12	18-8507	KIT MONTAJE	N/D	Usar con codo colector: 18-1909-1

Fits GM Small Block V8 305-350 cu. in.

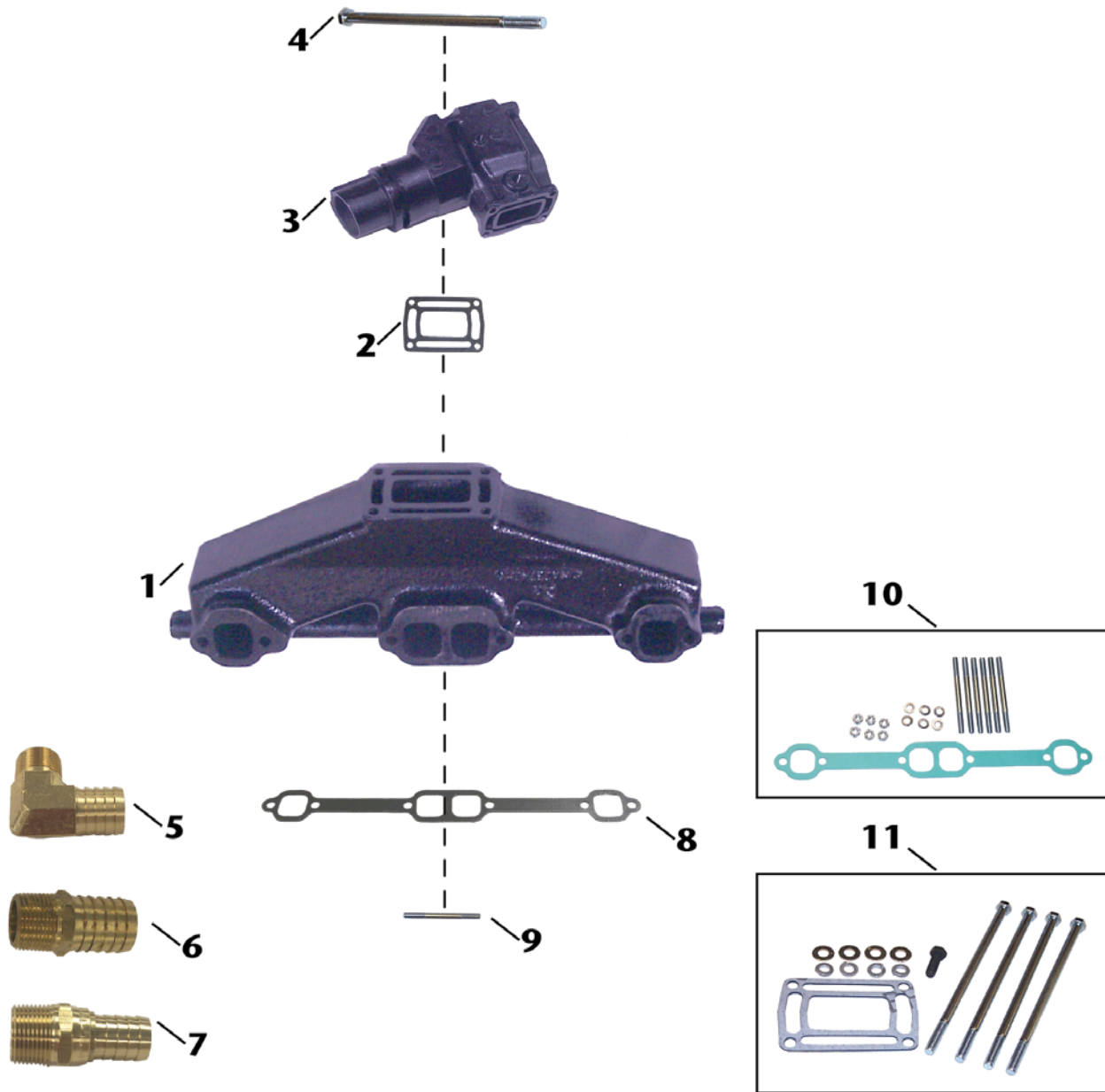

Ref	Descripción	OE No.	Aplicación	
1	18-1986-1	COLECTOR	3857723	GM Bloque pequeño (V8) 305-350 cu.in. Usar con junta colector: 18-2949; Kit montaje: 18-8502.
2	—	JUNTA CODO	909786	Usar con codo: 18-1909-1. Incluido en el kit de montaje 18-8507.
3	18-1909-1	CODO COLECTOR	913784, 3855270, 3850459, 3857944	Usar con colector: 18-1986-1; kit de montaje: 18-8507.
4	NSI	PERNO DE MONTAJE	N/D	Incluido en el kit de montaje 18-8507.
5	18-8216	ENTRONQUE	N/D	1/2" - 14NPT X 3/4" Manguera (Conector resistente a la corrosión)
6	18-4461	ENTRONQUE	N/D	3/4" - 14NPT X 1" Manguera (Conector resistente a la corrosión)
7	18-8215	ENTRONQUE	N/D	3/4" - 14NPT X 3/4" Manguera (Conector resistente a la corrosión)
8	18-2949	JUNTA COLECTOR	96306	Usar con colector: 18-1986-1. Incluido en 18-8502
9	NSS	ESPARRAGOS DE MONTAJE	N/D	Incluido en kit de montaje 18-8502.
10	18-8502	KIT DE MONTAJE	N/D	Usar con colector 18-1986-1. Incluye junta colector 18-2949.
11	18-8507	KIT DE MONTAJE	N/D	Usar con codo: 18-1909-1. Incluye junta codo 18-0943-2.

COLECTORES SIERRA

ESTÁN PINTADOS Y PROBADOS CONTRA FUGAS



**18-1901
COLECTOR**
Reemplaza: 984054
Para 181 CID modelo 140
y 3.0L (1973 - 1989)
Usar con: Junta codo escape 18-1204-1 & junta
codo 18-2875-1
*Para despiece - Mirar página 578



**18-1898
COLECTOR**
Babor & estribor
Reemplaza: Barr CHVA-1-84, Marine Power 0991-110
Para motores V8 454 cu.in. GM bloque grande
Usar con:
Junta colector escape: 18-0418



**18-1997-1
COLECTOR ESCAPE**
Babor & estribor
Reemplaza Barr CHV-1-83 Colector universal codo cen-
trado
Para: motores GM 283, 305, 307 y 350 CID
Usar con:
Juego juntas colector escape: 18-0604



**18-1998-1
COLECTOR ESCAPE**
Babor & Estribor
Reemplaza: Barr FM-1-83
Colector universal codo centrado
Para: Motores Ford 302 y 351 CID
Usar con:
Juego junta colector escape: 18-0603



**18-1986-1
COLECTOR**
Babor & Estribor
Reemplaza: 3852374, 3857723
Para: GM bloque pequeño V8 305-350 ci
Usar con:
Junta colector escape: 18-2949
Kit de montaje: 18-8502



**18-1902
COLECTOR**
Reemplaza: 912441
V-8 - ESTRIBOR
Para mayoría de bloques pequeños GM V-8 con salida extremo
Usar con:
Kit de montaje: 18-8502



**18-1903
COLECTOR**
Reemplaza: 912442 V-8 - PORT SIDE
Para mayoría de bloques pequeños GM V-8 con salida extremo
Usar con:
Kit de montaje: 18-8502



**18-1904
COLECTOR**
Babor y estribor
Reemplaza: 980959 V-8 - AMBOS LADOS
Para mayoría de Ford V-8 302 y 351W con salida extremo
Usar con:
Junta colector escape: 18-0183-1 or 18-2896-1
(Ver tabla de aplicaciones)



18-1876
CODO
 Reemplaza: 980617
 Usar con:
 Colector: 18-1904
 Junta codo: 18-2850
 Para: 170 (1974), 175 (1975-76),
 190 (1974-76), 235 (1975-76)



18-1991
30°ADAPTADOR CODO ESCAPE
 Para usar con 3" D.I.
 Manguera escape
 Usar con:
 Codo colector: 18-1999



18-1992-1
80° CODO ESCAPE
 Para manguera escape 3" D.I.
 (Como usado en el kit conversión colector de escape 18-1987)



18-1921
CODO COLECTOR
 Reemplaza: 909863
 V-8
 Para mayoría de bloques pequeños GM V-8
 Usar con:
 Colector: 18-1902, 18-1903
 Junta codo: 18-0943-2
 Kit de montaje: 18-8534



18-1922
COLECTOR CODO
 Reemplaza: 987784
 4 CIL.
 Para mayoría 140 HP 3.0L (181 CID)
 Usar con:
 Colector: 18-1901
 Junta codo: 18-2875-1



18-1909-1
CODO
 Reemplaza:
 OMC 913784, 3855270, 3850456,
 3857944
 VOLVO 3855270-9, 3857944-7, 3863061
 OMC codo, 4" salida 7": Para mayoría de colectores GM & Ford.
 Usar con:
 Colector: 18-1986-1
 Junta codo: 18-0943-2
 Kit de montaje: 18-8507



18-1939
CODO
 Reemplaza: Barr 20-0100, Marine Power 0992-593 Barr, Indmar y Marine Power Ford bloques pequeños V8 302-351cu.in., GM bloques pequeños V8 305-350cu.in., GM bloque grande V8 454cu.in.
 Usar con:
 Colector: 18-1997-1, 18-1998-1
 Junta codo: 18-2854-1 abierto o 18-0476-1 cerrado
 Kit montaje: 18-4364 abierto o 18-8535 cerrado
 4" manguera



18-1907
CODO
 Reemplaza: Barr 20-0102, Indmar 53-2009, 53-2018, Barr y Indmar Ford bloque pequeño V8 302-351cu.in.
 Usar con:
 Colector: 18-1997-1, 18-1998-1
 Junta codo: 18-2854-1 open or 18-0476-1 cerrado
 Kit montaje: 18-4364 abierto o 18-8535 cerrado
 3" manguera



18-1999
COLECTOR CODO ESCAPE
 Reemplaza: Barr 20-0082
 Usar con :
 Colector: 18-1997-1 or 18-1998-1
 Junta codo: 18-2854-1 abierto
 3 1/2" manguera
 Abierto está dentro del kit de montaje 18-4364
 Si es cerrado, es necesario utilizar el kit de montaje 18-8535
 Reemplaza: Barr 20-0082-P



18-4009
PLATINA COLECTOR
 Reemplaza: 910384



TAPONES

Ref #	Tamaño rosca
18-4256	1/4"
18-4257	1/4"
18-4258	3/4"
18-4263	1/8" - 27 NPT
18-4264	3/8" - 18 NPT

56507 Sellado con Teflon®
 Recomendado para conexiones.



18-4461
CONECTOR
 Manguera 3/4" - 14 NPT X 1"
 Conexiones resistentes a la corrosión



18-8216
CONECTOR
 1/2" - 14 NPT X 3/4" barb
 Para: OMC- 6 Cilindros en línea

① **18-4218D** Display Package



18-4218
TAPÓN VACIADO DE LATÓN
 Reemplaza: 379957
 1/4"
 18-3223-9 envase 12



18-4363
KIT DE MONTAJE
 Reemplaza: Barr FM-1-83-P
 Usar con:
 Colector: 18-1998-1



18-4364 (abierto)
KIT DE MONTAJE
 Reemplaza: Barr 20-0082-P
 Usar con
 Codo: 18-1999, 18-1939, 18-1907



18-8502
KIT MONTAJE
 OMC GM Bloque pequeño V8 305-350cu.in. (1979-89) OMC/Volvo GM bloque pequeño 305-350cu.in.
 Usar con:
 Colector: 18-1931-1,18-1902 & 18-1903



18-8507
KIT DE MONTAJE
 OMC/Volvo GM
 Bloque pequeño V8 305-350cu.in.
 Usar con:
 Codo: 18-1909-1



18-8534
KIT DE MONTAJE
 OMC GM Bloque pequeño V8 305-350cu.in. (1979-1989) y aplicaciones multiples codos Ford y GM
 Usar con:
 Codo: 18-1921



18-8535 (CERRADO)
KIT DE MONTAJE
 Barr, Indmar y Marine Power Ford bloque pequeño V8 302-351cu.in., GM bloque pequeño V8 305-350cu.in., GM bloque grande V8 454cu.in.
 Usar con:
 Codos: 18-1939, 18-1999, and 18-1907



18-8536
KIT DE MONTAJE
 Barr, Indmar y Marine Power GM bloque pequeño V8 305-350cu.in.
 Usar con:
 Colector: 18-1997-1



18-8538
KIT DE MONTAJE
 Barr y Indmar Ford bloque pequeño V8 302-351cu.in.
 Usar con:
 Colector: 18-1998-1, 18-1904



18-8553
KIT DE MONTAJE
 Usar con:
 Codo escape: 18-1921



18-2779
MANGUERA ESCAPE
 Reemplaza: 3852696



18-2781
MANGUERA ESCAPE
 Reemplaza: 3852742



18-0114
JUNTA COLECTOR
 Reemplaza: 907761









18-0183-1
JUNTA COLECTOR ESCAPE
 Reemplaza: 908717, 916262, 3852455, 3853742
 Usar con:
 Colector: 18-1958, 18-1962, 18-1904, 18-1998-1, 18-1996, 18-1979



18-0476-1 (CERRADO)
JUNTA CODO
 Reemplaza: Barr 01-0105
 Indmar & Marine Power Ford bloque pequeño V8 302-351cu.in.
 Usar con:
 Codos: 18-1939, 18-1999 y 18-1907

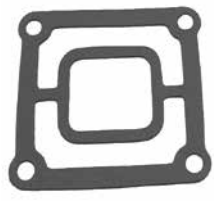

PACK DE 2
18-0943-2
18-0943-2-9①
JUNTA CODO ESCAPE
 Reemplaza: 909786, 3850496
 Usar con:
 Codo: 18-1909-1

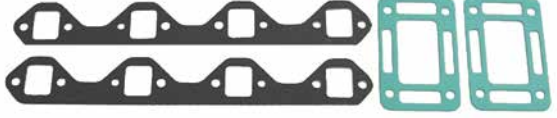
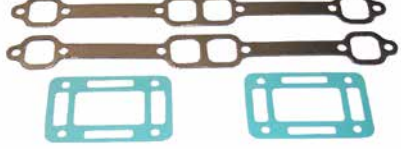
<p>PACK DE 2</p>  <p>18-2850 18-2850-9① JUNTA CODO ESCAPE Reemplaza: 908935</p>	<p>PACK DE 2</p>  <p>18-2854-1 18-2854-9① JUNTA CODO ESCAPE Reemplaza: Barr 01-0107 Usar con: Kit de montaje: 18-8535 Codos: 18-1999, 18-1939, 18-1907</p>	<p>PKG OF 2</p>  <p>18-2861-1 18-2861-9① JUNTA CODO ESCAPE Reemplaza: 311121</p>
<p>PACK DE 2</p>  <p>18-2875-1 18-2875-1-9① JUNTA CODO ESCAPE Reemplaza: 3850495, 908013 Usar con: Codo: 18-1922</p>	 <p>18-2896 JUNTA COLECTOR Reemplaza: 311068 Para GM 4 cil. 153 cu.in. primeros modelos 110/120 donde el carburador. va montado en la parte trasera del motor Usar con: Colector: 18-1904</p>	
<p>PACK DE 2</p>  <p>18-2902-1 18-2902-9① JUNTA COLECTOR Reemplaza: 909314 Usar con: Colector: 18-1997-1, 18-1986-1, 18-1902, 18-1903</p>	<p>PACK DE 2</p>  <p>18-2949 18-2949-9① JUNTA COLECTOR Reemplaza: Barr CHV-47-000 Usar con: Colector: 18-1997-1</p>	
 <p>18-0603 JUEGO JUNTAS COLECTOR ESCAPE Para: Motores Ford 302/351 CID. Usar con: Colector: 18-1998-1</p>	 <p>18-0604 JUEGO JUNTAS COLECTOR ESCAPE Para: Motores GM 305/350 CID Usar con: Colector: 18-1997-1</p>	

① Precio por pack

APLICACIÓN COLECTOR/JUNTA COLECTOR

Año	Potencia	Colector escape	Codo escape	Kit montaje colector	Kit montaje Codo	Junta Colector	Junta codo
1997-98	5.0/5.7L	18-1986-1	18-1909-1	18-8502	18-8507	18-2902-1	18-0943-2
1994-97	5.8L (Ford)	—	—	—	—	18-0183-1	18-0943-2
1994-97	7.4L (GM)	—	—	—	—	18-0418	18-0943-2
1991-93	3.0 Litro	—	18-1922	—	—	—	18-2875-1
1992-93	4.3/4.3 HO	—	18-1909-1	—	18-8507	—	18-0943-2
1993	5.0/5.0 HO/5.8 Litro	—	18-1909-1	—	18-8507	18-0183-1	18-0943-2
1993	5.0 & 5.8 EFI	—	18-1909-1	—	18-8507	18-0183-1 ②	18-0943-2
1993	5.0 & 5.8 EFI	—	18-1909-1	—	18-8507	—	18-0943-2
1993	5.8L (Ford)	—	18-1909-1	—	18-8507	18-0183-1	18-0943-2
1993	7.4L (GM), 8.2L (GM)	—	18-1909-1	—	18-8507	18-0418	18-0943-2
1993	351 King, 454/454 HO/502	—	—	—	—	—	18-0943-2
1992	5.0/5.0 HO/5.8 Litro	—	18-1909-1	—	18-8507	18-0183-1	18-0943-2
1992	5.8L (Ford)	—	—	—	—	18-0183-1	18-0943-2
1992	7.4L (GM), 8.2L (GM)	—	—	—	—	18-0418	18-0943-2
1992	351 King Cobra	—	—	—	—	18-0183-1	18-0943-2
1992	454/454 HO/502	—	—	—	—	—	18-0943-2
1991	4.3/4.3 HO	—	—	—	—	—	18-0943-2
1991	5.8L (Ford), 5.0/5.0HO/5.8 Litro	—	18-1909-1	—	18-8507	18-0183-1	18-0943-2

② Sólo 5.0L

APLICACIONES CONTINUÁN EN LA SIGUIENTE PÁGINA

APLICACIÓN COLECTOR/JUNTA COLECTOR

Año	Potencia	Colector escape	Codo escape	Kit montaje colector	Kit montaje Codo	Junta colector	Junta codo
1991	454/454 HO	—	18-1909-1	—	18-8507	—	18-0943-2
1991	7.4L (GM)	—	18-1909-1	—	18-8507	18-0418	18-0943-2
1990-91	8.2L (GM)	—	18-1909-1	—	18-8507	—	—
1982-83,1985-90	3.0 Litros	18-1901	18-1922	—	—	—	18-2875-1
1990	4.3 Litros	—	18-1909-1	—	18-8507	—	—
1990	5.0/5.0 HO/5.8 Litros	—	18-1921	—	—	18-0183-1	18-0943-2
1990	5.0/5.7L	18-1986-1	18-1909-1	18-8502	18-8507	18-2902-1	18-0943-2
1990	7.4L (GM)	—	—	—	—	18-0418	18-0943-2
1990	7.5L (Ford)	—	—	—	—	18-0992	18-0943-2
1990	454 King Cobra	—	—	—	—	—	18-0943-2
1987-90	460 King Cobra	—	—	—	—	—	18-0943-2
1989	5.0/5.0 HO/5.8 Litros	—	18-1921	—	18-8534	18-0183-1	18-0943-2
1989	5.7/350 King Cobra	—	—	—	—	18-2902-1	18-0943-2
1988	5.0/5.7/350 King Cobra	18-1902 #	18-1921	18-8502	18-8534	18-2902-1	18-0943-2
1988	5.0/5.7/350 King Cobra	18-1903 *	18-1921	18-8502	18-8534	18-2902-1	18-0943-2
1988	370 King Cobra	—	—	—	—	—	18-0943-2
1982-87	5.0/5.7 Litros	18-1902 #	18-1921 ①	18-8502	18-8534	18-2902-1	18-0943-2
1982-87	5.0/5.7 Litros	18-1903 *	18-1921	18-8502	18-8534	18-2902-1	18-0943-2
1982-86	2.5 Litros	18-1901	18-1922	—	—	18-2896-1	18-2875-1
1984	3.0 Litros	18-1901	18-1921	—	18-8534	—	18-2875-1
1978-81	400 Series, 120 HP	—	—	—	—	18-2896-1	18-2861-1
1978-81	400 Series, 140 HP	—	18-1922	—	—	—	18-2875-1
1981	800 Series, 200,230,260 HP	18-1902 #	18-1921	18-8502	18-8534	18-2902-1	18-0943-2
1981	800 Series, 200,230,260 HP	18-1903 *	18-1921	18-8502	18-8534	18-2902-1	18-0943-2
1980	800 Series, 185-260 HP	18-1902 #	18-1921	18-8502	18-8534	18-2902-1	18-0943-2
1980	800 Series, 185-260 HP	18-1903 *	18-1921	18-8502	18-8534	18-2902-1	18-0943-2
1979	800 Series,185-230 HP	18-1902 #	18-1921	18-8502	18-8534	18-2902-1	18-0943-2
1979	800 Series,185-230 HP	18-1903 *	18-1921	18-8502	18-8534	18-2902-1	18-0943-2
1979	800 Series, 260 HP	18-1902 #	18-1921	18-8502	18-8534	18-2902-1	18-0943-2
1979	800 Series, 260 HP	18-1903 *	18-1921	18-8502	18-8534	18-2902-1	18-0943-2
1978	800 Series, 185-225 HP	18-1902 #	18-1921	18-8502	18-8534	18-2902-1	18-0943-2
1978	800 Series, 185-225 HP	18-1903 *	18-1921	18-8502	18-8534	18-2902-1	18-0943-2
1978	800 Series, 240 HP	—	18-1921	—	18-8534	—	—
1977	120 HP	—	—	—	—	18-2896-1	18-0943-2
1977	140 HP	—	18-1922	—	—	—	18-2861-1
1977	175 Hasta 235 HP	—	18-1921	—	18-8534	18-0183-1	18-2875-1
1976	120 HP	18-1904	—	—	—	18-0183-1	18-0943-2
1974-76	140 HP	18-1904	18-1922	—	—	—	18-2861-1
1976	165 HP	18-1904	18-1922	—	—	18-2830-1	18-2875-1
1976	175 Hasta 235 HP	18-1904	—	—	—	18-0183-1	18-2875-1
1974-75	120 HP	18-1904	—	—	—	18-2896-1	18-2850
1974-75	165 HP	18-1904	18-1922	—	—	—	18-2875-1
1975	175 Hasta 235 HP	18-1904	—	—	—	18-0183-1	18-2875-1
1974	170 & 190 HP	18-1904	—	—	—	18-0183-1	18-2875-1
1974	175 THRU 235 HP	18-1904	—	—	—	18-0183-1	18-2850
1973	100,120,140 HP	—	—	—	—	18-2896-1	18-2861-1
1973	165 HP	—	18-1922	—	—	18-2896-1	18-2861-1
1972-73	225 & 245 HP	—	—	—	—	—	18-2883
1972	100,120 HP	—	—	—	—	18-2896-1	18-2861-1
1972	155 HP	—	—	—	—	N/D	18-2883
1972	165 HP S MODEL, C MODEL	—	—	—	—	—	18-2875-1
1971	215 & 235 HP	—	—	—	—	—	18-2859
1965-71	120 HP	—	—	—	—	—	18-2861-1
1967-71	155 HP	—	—	—	—	N/D	18-2859
1968-70	210 HP	—	—	—	—	—	18-2859
1967-68	185 HP	—	—	—	—	—	18-2859
1966-68	200 HP	—	—	—	—	N/D	18-2859
1964-66	150 HP	—	—	—	—	N/D	18-2859
1964	110 HP	—	—	—	—	N/D	18-2859

Estribor

* Babor

① Codo alto para 1985

② Sólo 5.0L

FILTRO ACEITE



Display Package

Ref #	Para:	O.E.M #
18-7824-1	Motor GM (filtro corto)	173232, 502902
18-7875	motor Ford (Filtro largo)	173231, 502900
18-7876	Motor GM (Filtro largo)	173233, 502901
18-7878-1	M-100, M200 (Filtro corto)	502904
18-7879-1	Motor GM V-6	173834, 502903

CULATAS



**18-4485
CULATA**

Para: 5.7L V-8 GM (1987-95) con 12 pernos en el colector de admisión. Para tapa de válvula con tornillos en el centro.



**18-4486
CULATA**

Para: 5.7L V-8 GM Vortec (1996-sup) con 8 pernos en el colector de admisión. Para tapa de válvula con tornillos en el centro.



**18-4486HP
CULATA**

Para: Vortec GM Bloque pequeño 5.7L Altas prestaciones
Completamente ensamblado con carreras y camaras de combustión revisados. Añade 30 hp de potencia adicional sin modificaciones.

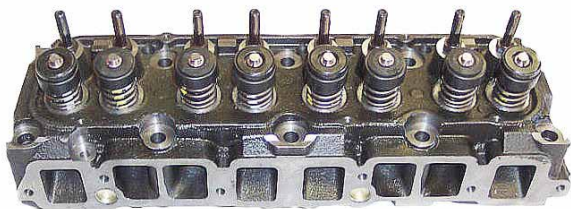

**18-4489
CULATA**

Para: 2.5L/3.0L GM (1968-95)



**18-4491
CULATA**

Reemplaza 4.3L Vortec V-6 (1996-Sup) con 8 pernos en el colector de admisión .
Para tapa de válvula con tornillos en el centro



**18-4501
CULATA**

Para: 5.0L Vortec



**18-4501HP
CULATA**

Para: Vortec GM bloque pequeño 5.0L
Completamente ensamblado con carreras y camaras de combustión revisados. Añade 30 hp de potencia adicional sin modificaciones.





18-1400
LEVA HIDRÁULICA
Reemplaza: 3856127
GM 4.3L/V-6/5.0L/5.7L



18-1401
LEVA HIDRÁULICA
Reemplaza: 3853847, 985316
Ford 5.0L y 5.8L



18-1402
LEVA HIDRÁULICA
Reemplaza: 3854033, 502036
GM 2.5L/120
Para: OMC & Volvo 3.0L/181 CID

TODOS LOS PISTONES
SE SUMINISTRAN COMPLETOS, CON AROS, BULÓN Y PASADOR.



AROS (Cont.)

STD	REEMPLAZA OMC / VOLVO
18-3944	370409
.020	
18-3939	3854252
18-3939	914556
.030	
18-3938	*14089026
18-3938	328516
18-3938	914557

AROS

STD	REEMPLAZA OMC / VOLVO
18-3937	*14089025
18-3937	328506
18-3937	3853960
18-3937	914555
18-3937	3853268
18-3937	985083, 986336
-	328536

PISTONES

18-4161	3853340
	914816
18-4173	*14077948
18-4173	3911020
.020	
18-4160	3853477, 915236
.030	
18-4164	*14077949
	3911023

* OMC Referencias GM Número

PISTONES / APLICACIONES ARO

Modelo	PISTONES			AROS			Cant. Per motor.
	Std.	.020	.030	Std.	.020	.030	
OMC							
GM							
2.5L/153 CID	18-4180	18-4183	-	18-3942	-	-	4
3.0L/181 CID	18-4161	18-4160	18-4191	18-3937	18-3939	18-3938	4
I-6/250 CID	-	-	-	18-3942	-	-	6
4.3L/V-6	18-4173	18-4188	18-4164	18-3937	18-3939	18-3938	6
5.0L/305 CID	-	-	18-4178	18-3944	-	-	8
5.7L/350 CID	18-4173	18-4188	18-4164	18-3937	18-3939	18-3938	8
7.4L/454 CID	18-4171	18-4189	18-4172	18-3940	-	-	8
FORD							
5.0L/302 CID	-	-	-	18-3937	18-3939	18-3938	8





COJINETE BIELA

Ref #	Tamaño
18-1308	Std.
18-1309	.010
18-1327	Std.
18-1329	Std.
18-1333	.010
18-1334	Std.
18-1337	.010
18-1341	.020

Se venden individualmente,
1 por biela



COJINETE CIGÜEÑAL

Ref #	Para Motor	Tamaño	Ref #	Para motor	Tamaño
18-1300	①	Std.	18-1316	①	.010
18-1311	①	Std.	18-1317	①	Std.
18-1315	①	Std.			

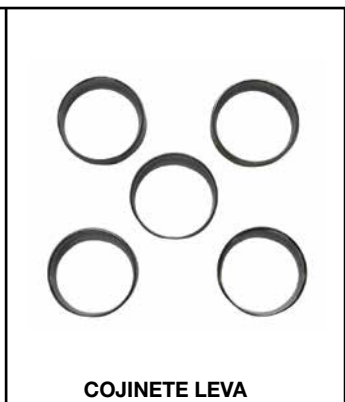

COJINETE LEVA

Ref #	Para motor.
18-1339	1 ①

① Juego de motor completo

APLICACIÓN COJINETE

Modelo	COJINETE BIELA			COJINETE CIGÜEÑAL			COJINETE LEVA
	Std.	.010	.020	Std.	.010	.020	

OMC

Modelo	18-1329	18-1330	-	18-1317	18-1316	-	18-1339
2.5L/153 CID							
3.0L/181 CID							
I-6/230 CID							
I-6/250 CID							
4.3L/V-6							
5.0L/305 CID							
5.7L/350 CID							
7.4L/454 CID							

FORD

5.0L/302 CID	-	-	-	-	-	-	-
--------------	---	---	---	---	---	---	---



Retenes cigüeñal una pieza

18-1234
Reemplaza:
3853528

18-0519
Reemplaza
3852657, 912957



Retenes cigüeñal dos piezas

18-0528
Reemplaza:
913745

18-1211
Reemplaza:
473424



Retenes tapa distribución

18-1213
Reemplaza:
3853341
912989, 914817













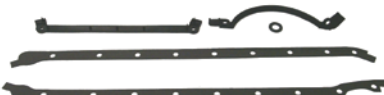

18-1233
Reemplaza: 3860095

APLICACION RETENES OMC

Modelo motor	2 Retén principal trasero Junta del cigüeñal Conv. Rotación (LH)	Retén tapa distribución
GM		
2.5L/153 CID	18-1211 ②	18-1213
3.0L/181 CID	18-1211 ②	18-1213
I-6/230CID	18-1211 ②	18-1213
I-6/250CID	18-1211 ②	18-1213
4.3L/V-6	18-1211 ②	18-1213
5.0L/305 CID	18-1211 ①	18-1213
5.7L/350 CID	18-1211 ①	18-1213
7.4L/454 CID	③	18-1233
FORD		
5.0L/302 CID	18-0528	
5.8L/351 CID	-	18-1230

① Cigüeñal largo motores GM ② Para retenes de una sola pieza (LH) Use 18-0519 ③ Para retenes de una sola pieza (LH) Use 18-1234

JUEGO DE JUNTAS VARIOS

 <p>18-0465 JUEGO JUNTAS COLECTOR ADMISIÓN Reemplaza: 352670 Para: motores GM 454 CID, 325, 330, 340, 350 HP y 454 Magnums, 7.4L</p>	 <p>18-0153 JUEGO DE JUNTAS CARTER Reemplaza: 393159, 458625, 357159 Para: OMC 5.7L</p>	 <p>18-0340 JUEGO DE JUNTAS CARTER Reemplaza: 508713</p>
 <p>18-1239 JUNTA CÁRTER Reemplaza: 914820 Para: OMC 3.0L</p>	 <p>18-0348 JUEGO DE JUNTAS CARTER Reemplaza: 3931593, 508871</p>	 <p>18-1237 JUNTA CARTER Reemplaza: 3856138 Para: GM 5.7L</p>
 <p>18-0466 JUEGO DE JUNTAS CARTER Reemplaza: 393061, 3923440, 3921473</p>	 <p>18-1238 JUEGO DE JUNTAS Reemplaza: 3850379, 912979 Para: OMC 4.3L 1993-96</p>	 <p>18-1231 JUNTA ADMISIÓN Reemplaza: 3854095</p>
 <p>18-0405 JUNTA CARTER Reemplaza: 3852655, 912955 Para: OMC 4.3L</p>	 <p>18-0407 JUEGO JUNTAS CARTER Reemplaza: 508872</p>	 <p>18-0410 JUEGO JUNTAS COLECTOR ADMISIÓN Reemplaza: 988162, 3854406, 986103, 3853912, 986104, 3853913 Para: OMC 5.0L & 5.8L (1989-96)</p>
 <p>18-0411 JUEGO JUNTAS CARTER Reemplaza: 458625, 357159, 508876</p>	 <p>18-1232 JUNTA CARTER Reemplaza: 3853510</p>	 <p>18-0868 JUEGO JUNTAS COLECTOR DE ADMISIÓN Reemplaza: 985630, 3854269 Para: OMC 5.7L 1994, 1996-97</p>

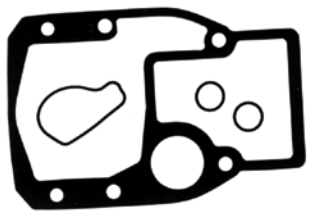

Display Package

18-2613
JUEGO JUNTAS COLA
 Reemplaza: 508105

— CONTIENE —

Ref #	Descripción	O.E. #	Cant.
18-2918	Junta	911836	1
18-2996	Retén	911823	1
18-7153	Aro tórico	911851	2

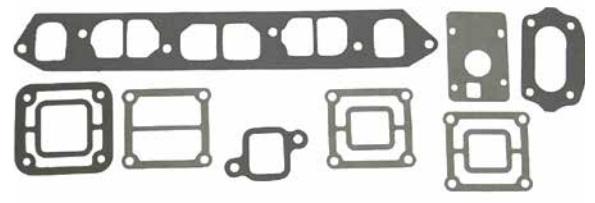

18-4369
JUEGO JUNTAS COLECTOR DE ESCAPE
 Para: 2.5L (1985-86) y
 3.0L (1985-88)



18-2699
JUEGO JUNTAS KIT MONTAJE
 Para: colas SX
 Use tuercas montaje 18-3721

— CONTIENE —

Ref #	Descripción	O.E. #	Cant.
18-7153	Aro tórico	911851	2
18-2996	Retén	911823	1

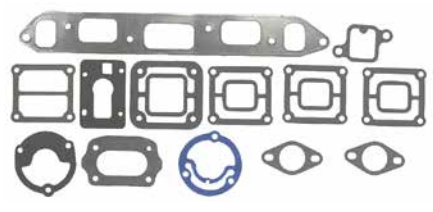

18-4370
JUEGO JUNTAS COLECTOR
 Para: 100, 120 HP y 2.5L (1965-85)

— CONTIENE —

Ref #	Descripción	O.E. #	Cant.
18-0114	Junta colector	907761	1
18-2896-1	Junta colector escape	311068	1
18-0104	Junta codo escape	907764	1
18-0164	Junta alojamiento termostato	311069	1
18-0937	Juntas carburador	315055	1
18-2861-1	Junta	311121	3
18-2875-1	Junta de codo colector	908013	1
18-2858	Junta alojamiento termostato	314809	1

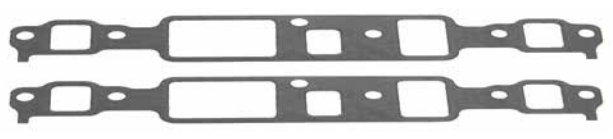

18-4408
JUEGO JUNTAS COLECTOR ENTRADA
 Reemplaza 912978
 Para: GM 4.3L

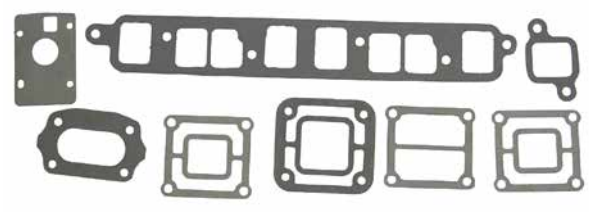



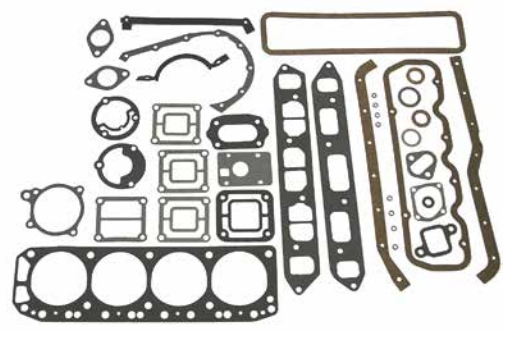



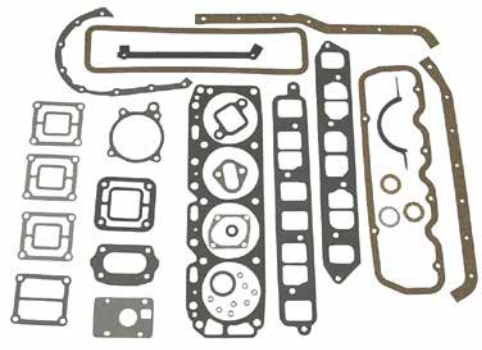













18-4371
JUEGO JUNTAS COLECTOR ESCAPE
 Para: 140 HP y 3.0L (1973-84)



















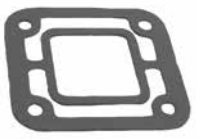

18-4373
JUEGO JUNTAS
 Para: 110, 120 HP y 2.5L (1965-86)





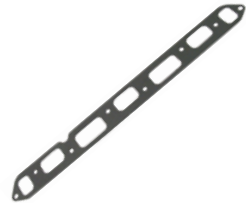





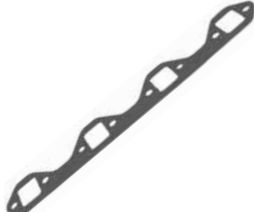
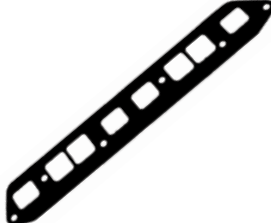

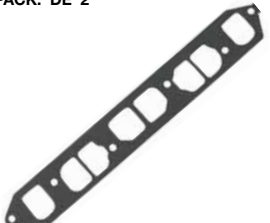



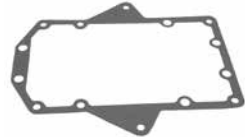

18-4374
JUEGO JUNTAS
 Para: 140 HP y 3.0L (1973-88)

 <p>18-2946 JUNTA CULATA Reemplaza: 3853336, 908611 Para: motor GM 181 (3.0L) CID</p>	 <p>18-3874 JUNTA CULATA Reemplaza: 3853511 Para: (8.2L) 502 CID</p>	 <p>18-3876 JUNTA CULATA Reemplaza: 3853380, 914971 Para: motor GM 305 (5.0L)/350 (5.7L) CID.</p>	 <p>18-3877 JUNTA CULATA Reemplaza: 914849 Para: Motor GM 454 (7.4L) CID.</p>
 <p>18-3878 JUNTA CULATA Reemplaza: 912766 Para: 460 Ford</p>	 <p>18-3879 JUNTA CULATA Reemplaza: 3854299, 912227, 914930 Para: motor GM 262 (4.3L) CID.</p>	 <p>18-3880 JUNTA CULATA Reemplaza: 311210 Para: Motor GM 153 (2.5L), (3.0L) CID.</p>	 <p>18-3881 JUNTA CULATA Reemplaza: 908237 Para: motor GM 250 (4.1L) CID (6 cil).</p>
 <p>18-3883 JUNTA CULATA Reemplaza: 3853732 Para: motores Ford 302 (5.0L) 351 (5.8L) CID.</p>	 <p>18-3887 JUNTA CULATA Reemplaza: 915325 Para: (7.4L) 454 CID GEN V</p>	 <p>18-0434 JUNTA MONTAJE CARBURADOR Reemplaza: 909758</p>	<p>PACK DE 2</p>  <p>18-5399 18-5399-9① JUNTA TAPA DISTRIBUIDOR Reemplaza: 910169</p>
<p>PACK. DE 2</p>  <p>18-0874 18-0874-9① JUNTA DISTRIBUIDOR Para GM V6 & V8 Reemplaza: 3852109, 312780 Para: 2.6L (1989), 3.5L (1989), 4.3L (1987-93), 5.0L (1987-88), 5.7L (1987-92), 7.4L (1988-93), 8.2L (1992-93)</p>	<p>PACK. DE 2</p>  <p>18-0937 18-0937-9① JUNTA MONTAJE CARBURADOR Reemplaza: 315055</p>	<p>PACK. DE 2</p>  <p>18-0435 JUNTA MONTAJE CARBURADOR Reemplaza: 908765</p>	<p>PACK. DE 2</p>  <p>18-0876 18-0876-9① JUNTA BOMBA COMBUSTIBLE Para GM 4.3L, 5.0L & 5.7L Reemplaza: 3852113, 312800</p>
<p>PACK. DE 2</p>  <p>18-0164 18-0164-9① JUNTA TERMOSTATO 4 & 6 Cil. Reemplaza: 311069 GM 3789161</p>	<p>PACK. DE 2</p>  <p>18-0929 18-0929-9① JUNTA TERMOSTATO Reemplaza: 313416</p>	<p>PACK. DE 2</p>  <p>18-2858 18-2858-9① JUNTA TERMOSTATO Reemplaza: 314809</p>	<p>PACK. DE 2</p>  <p>18-2917 18-2917-9① JUNTA TERMOSTATO Reemplaza: 312797, 3701777 (GM)</p>

<p>PACK DE 2</p>  <p>18-2947 18-2947-9① JUNTA TERMOSTATO Reemplaza: 310913</p>	<p>PACK. DE 2</p>  <p>18-0104 18-0104-9① JUNTA CODO ESCAPE Reemplaza: 907764</p>	 <p>18-0114 JUNTA COLECTOR Reemplaza: 907761 Para GM 4 Cil.</p>	
 <p>18-0430 JUNTA CODO ESCAPE Reemplaza: 912477</p>	<p>PACK. DE 2</p>  <p>18-0673 18-0673-9① JUNTA CODO ESCAPE Reemplaza: 910113</p>	<p>PACK. DE 2</p>  <p>18-0943-2 18-0943-2-9① JUNTA CODO ESCAPE Reemplaza: 913783, 909786, 3850496</p>	<p>PACK. DE 2</p>  <p>18-2850 18-2850-9① JUNTA TAPA COLECTOR Reemplaza: 908935</p>
<p>PACK. DE 2</p>  <p>18-2859 18-2859-9① JUNTA TAPA COLECTOR Reemplaza: 311131</p>	<p>PACK. DE 2</p>  <p>18-2860 18-2860-9① JUNTA TAPA COLECTOR Reemplaza: 311130</p>	<p>PACK. DE 2</p>  <p>18-2861-1 18-2861-9① JUNTA TAPA COLECTOR Reemplaza: 311121</p>	<p>PACK DE 2</p>  <p>18-2875-1 18-2875-1-9① JUNTA CODO ESCAPE Reemplaza: 908013, 3850495</p>
<p>PACK. DE 2</p>  <p>18-2883-1 18-2883-1-9① JUNTA TAPA COLECTOR Reemplaza: 907775</p>	 <p>18-2541 RETÉN GOMA Reemplaza: 911704</p>	 <p>18-0401 JUNTA COLECTOR ESCAPE Reemplaza: 913393 Para Ford 140 CID (2.3L)</p>	 <p>18-0431 JUNTA COLECTOR ADMISIÓN Reemplaza: 912471 Para Ford 140 CID (2.3L)</p>
 <p>18-0956-1 JUNTA COLECTOR ESCAPE Reemplaza: 912405 460 CID</p>	 <p>18-2912-1 JUNTA COLECTOR ESCAPE Reemplaza: 908079</p>	 <p>18-2830-1 JUNTA COLECTOR ESCAPE Inline 6 cil. Reemplaza: 907932</p>	 <p>18-2896-1 JUNTA COLECTOR ESCAPE Reemplaza: 311068</p>

① Precio por pack

<p>PACK. DE 2</p>  <p>18-2909 18-2909-9① JUNTA COLECTOR ESCAPE Reemplaza: 915025 GM V-6</p>	 <p>18-0183-1 JUNTA COLECTOR ESCAPE Reemplaza: 3853742, 3852455, 908717, 916262 Para: OMC 5.0L & 5.8L (1993-96)</p>	 <p>18-0680 JUNTA COLECTOR ESCAPE Reemplaza: 3853256</p>	 <p>18-0418 JUNTA COLECTOR ESCAPE Reemplaza: 909613</p>
<p>PACK. DE 2</p>  <p>18-1204-1 18-1204-1-9① JUNTA COLECTOR ESCAPE Reemplaza: 912164</p>	 <p>18-0892 MANGUITO DEFLECTOR Reemplaza: 322411</p>	 <p>18-0664 JUNTA TAPA VÁLVULA Reemplaza: 913270, 3852687 Para: GM 305/350, 5.0 & 5.7L</p>	 <p>18-2845 JUNTA TAPA VÁLVULA Reemplaza: 912965 Para GM 305/350 CID (5.0L y 5.7L)</p>
 <p>18-0311 JUNTA TAPA VÁLVULA Reemplaza: 3854942 Para: 4.3 Litro 262 CID</p>	 <p>18-0346 JUNTA TAPA VÁLVULA Reemplaza: 3930912 Para: GM 250 CID (4.1L), 160/165/200 (6 cil.)</p>	 <p>18-0347 JUNTA TAPA VÁLVULA Reemplaza: 3852693, 912981, 913277 Para: GM 153 & 181 CID (2.5L & 3.0L)</p>	<p>Pack. de 2</p>  <p>18-0464 18-0464-9① JUNTA TAPA VÁLVULA Reemplaza: 912768 Para: GM 454/502 CID (7.4L & 8.2L)</p>
 <p>18-0352 JUNTA TAPA VÁLVULA Reemplaza: 913758 Para: Ford 302/351 CID (5.0L & 5.8L)</p>	 <p>18-0548 JUNTA ADAPTADOR A ALOJAMIENTO INTERMEDIO Reemplaza: 909515</p>	<p>Pack. de 2</p>  <p>18-0947 18-0947-9① JUNTA Reemplaza: 909529</p>	<p>Pack. de 2</p>  <p>18-0440 18-0440-9① JUNTA Reemplaza: 915719</p>
 <p>18-0911 JUNTA BOMBA AGUA Reemplaza: 911698</p>	<p>Pack. de 2</p>  <p>18-0903 JUNTA BOMBA AGUA Reemplaza: 3853361 454 CID</p>	 <p>18-0147 JUNTA BOMBA AGUA Para Ford V-8 Reemplaza: 3852824</p>	 <p>18-0327 JUNTA BOMBA AGUA Reemplaza: 3853342 4 & 6 Cil.</p>

<p>PACK. DE 2</p>  <p>18-2916 18-2916-9① JUNTA ALOJAMIENTO BOMBA AGUA Reemplaza: 911702</p>	 <p>18-0939 18-0939-9① JUNTA Reemplaza: 315189</p>	 <p>18-0468 JUNTA TAPA DISTRIBUCIÓN Reemplaza: 3853512, 912954, 3852654, 915326 Para: OMC 2.6L, 3.5L (1989), 4.3L (1987-93), 5.0L (1987-88), 5.7L (1987-92, 1994, 1996)</p>	<p>PKG. OF 2</p>  <p>18-0891 18-0891-9① JUNTA MONTAJE BOMBA AGUA Reemplaza: 3852477, 909835 Para: GM 4.3L, 5.0L & 5.8L</p>
<p>PKG. OF 2</p>  <p>18-0893 18-0893-9① JUNTA BOMBA AGUA Reemplaza: 3850595 GM 4.3L, 5.0L & 5.7L</p>	<p>PKG. OF 2</p>  <p>18-0322 18-0322-9① JUNTA Reemplaza: 3852656 GM 5.0L & 5.7L</p>	 <p>18-0329 junta varilla empuje</p>	<p>PKG. OF 2</p>  <p>18-0887 18-0887-9① JUNTA TAPA DISTRIBUCIÓN Reemplaza: 3852691, 912988, 913275 4 & 6 Cil.</p>
 <p>18-0980 JUNTA TAPA DISTRIBUCIÓN Reemplaza: 3935449 GM 7.4L</p>	<p>PKG. OF 2</p>  <p>18-0880 18-0880-9① JUNTA TAPA CAMBIO Reemplaza: 911878</p>	<p>PKG. OF 2</p>  <p>18-0166 18-0166-9① CASQUILLO Reemplaza: 911705</p>	 <p>18-2815 VARILLA DE EMPUJE Reemplaza: 3852692, 913276 Para: 3.0L</p>
 <p>18-0190 JUNTA Reemplaza: 912157</p>	<p>PACK. DE 2</p>  <p>18-2851 18-2851-9① JUNTA COJINETE Reemplaza: 313368</p>	<p>PACK DE 2</p>  <p>18-2863 18-2863-9① JUNTA TAPA TILT Reemplaza: 308799</p>	<p>PACK DE 2</p>  <p>18-0913 JUNTA MOTOR TILT Reemplaza: 909902</p>

① Precio por pack

<p>PKG. OF 2</p>  <p>18-2911 18-2911-9① JUNTA ALOJAMIENTO COJINETE CARDAN Reemplaza: 910236</p>	<p>PKG. OF 5</p>  <p>18-2918 18-2918-9① JUNTA TRANSOM Reemplaza: 911836, 915840</p>	<p>PKG. OF 5</p>  <p>18-2996 18-2996-9① JUNTA RETÉN Reemplaza: 911823, 3852560</p>	<p>PKG. OF 2</p>  <p>18-0923 18-0923-9① RETÉN GOMA Reemplaza: 313244</p>
<p>PKG. OF 2</p>  <p>18-0188 18-0188-9① ARANDELA Reemplaza: 909748</p>	<p>PKG. OF 5</p>  <p>18-2387 18-23871-9① (PACK. DE 50) TORNILLO DRENAJE Reemplaza: 307551 Para: OMC V-6, V-4(1979 & Sup), 60-75hp 3 cilindro, 20-35hp (1985-97)</p>	<p>PKG. OF 5</p>  <p>18-1236 TORNILLO DRENAJE Reemplaza: 309243 Para Cobra Drives & V-6 40-50HP (1989-97)</p>	<p>PKG. OF 2</p>  <p>18-2378 18-23781-9① (Pack. de 50 sin arandela) TORNILLO MAGNÉTICO DE DRENAJE Reemplaza: 318544 Para: Cobra 2.3, 3.0, 3.8 & 5.8L (1986-92), V-6, V-4(1979 & Sup), 60-75hp 3 cil, 40/50hp (1989-98)</p>
<p>PACK. DE 5</p>  <p>18-4253-9① 18-42531-9① (Pack. de 50) ARO TÓRICO TORNILLO DRENAJE Reemplaza: 336982 Usar con tornillo 18-1236</p>	<p>PACK. DE 2</p>  <p>18-2945 18-2945-9① JUNTA TORNILLO DRENAJE Reemplaza: 307552</p>	<p>PACK. DE 2</p>  <p>18-8369 INDICADOR DE ACEITE CON ARANDELA Reemplaza: 914488 Usar aro 18-7116 Para: OMC Cobra (1986-93) Sin agarre cónico</p>	<p>PACK. DE 5</p>  <p>18-4248 18-4248-9① 18-42481-9① (PACK. DE 50) ARANDELA (Plástico) Reemplaza: 311598</p>
<p>PACK. DE 5</p>  <p>18-4250 18-4250-9① ARANDELA Reemplaza: 911820</p>	<p>TAPA TAPÓN</p>  <p>18-0549 Reemplaza: 909829 D.I. 1" Para modelo V-8 transmisión e intraborda (1977 hasta hoy)</p>  <p>18-0550 Reemplaza: 909830 D.I. 1 1/4" Para modelo V-8 transmisión e intra borda (1977 hasta hoy)</p>	<p>PKG. OF 5</p>  <p>18-0518 RETÉN VÁLVULA Reemplaza: 3854956, 914323, 3853132 Para: mayoría 4 y 6 cil. en línea GM (primeros) y 305-350 CID GM</p>	<p>PACK. DE 8</p>  <p>18-4024 18-4024-9① RETÉN VÁLVULA Reemplaza: 3853226, 914445 Para: Chevy 4.3L/5.0L/5.7L</p>

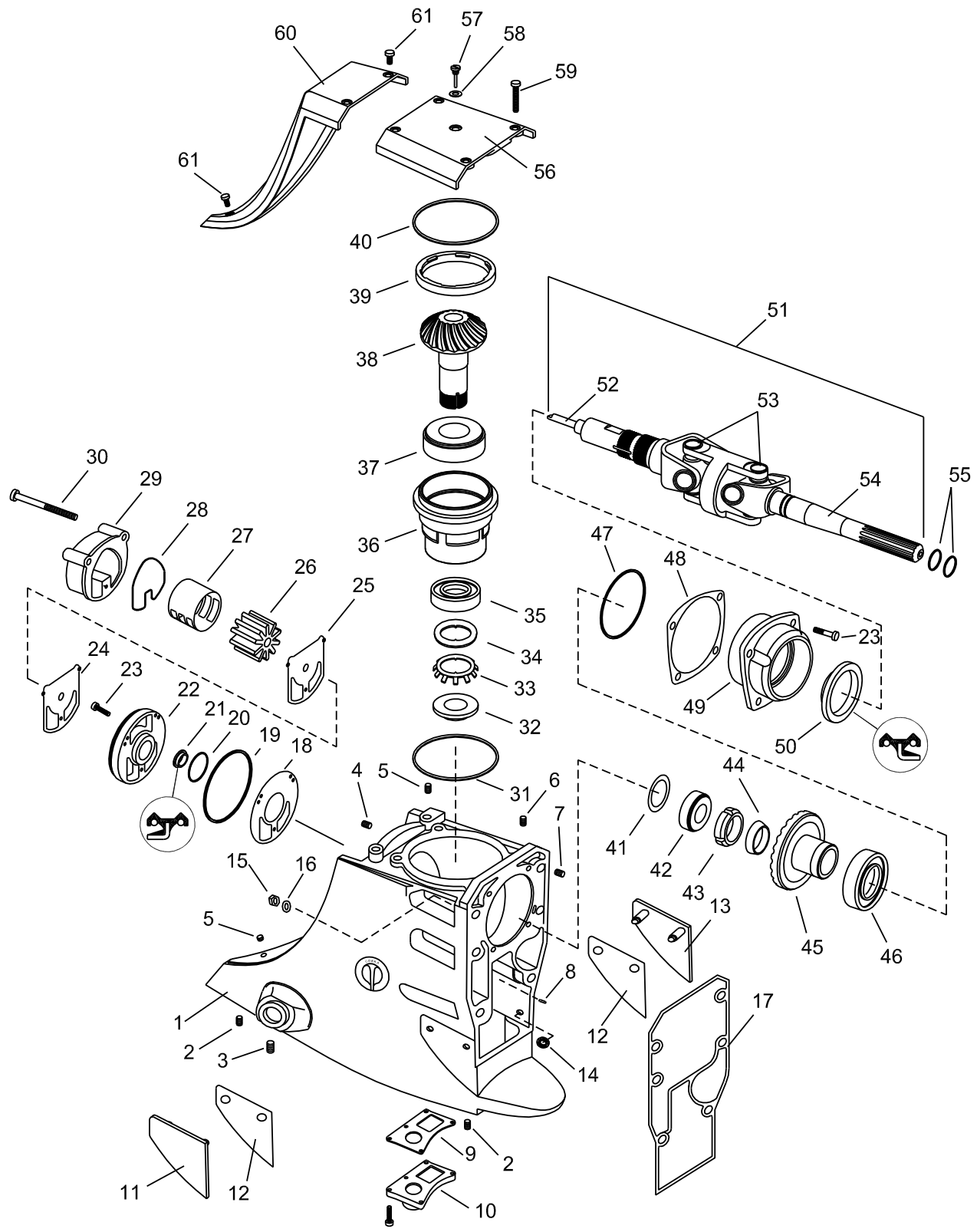

Núm. #	Descripción	Ref #	O.E.M. #	Cant.	Núm #	Descripción	Ref #	O.E.M. #	Cant.
1	Alojamiento superior, Básico con Inserción	~	984518	1	32	Tuerca piñón	18-3769	911753	1
					33	Tuerca	18-3610	911752	1
2	Inserción cola	NSS	910935	5	34	Arandela piñón	NSS	911697	1
3	Inserción cola	NSS	911779, 3852541	5	35	Cojinete	18-1170	983892	1
					36	Cojinete de apoyo piñón	18-4828	911750	1
4	Inserción cola	NSS	910901	5	37	Cojinete piñón superior	18-1161	983891	1
5	Inserción cola	NSS	911858, 3852567	3	38	Set engranajes, 21:16 (incluye 38 & 45)	18-1600	983825	AR
					38	Set engranajes, 21:18 (incluye 38 & 45)	18-1601	983826	AR
6	Inserción cola	NSS	910901	4	38	Set engranajes, 21:19 (incluye 38 & 45)	18-1602	984012	AR
7	Inserción cola	NSS	910901	4					
8	Guía cambio	NSS	912137	1	39	Tuerca	18-3768	911751	1
9	Junta	18-0884	911733	1	40	Aro tórico	18-7107	313175	1
10	Tapa	18-4837	911734	1					
11	Platina empuje estribor	NSS	911838, 3852562	1	41	Cojinete posición engr. 0.003"	18-02062	911662	AR
					41	Cojinete posición engr. 0.005"	18-02063	911663	AR
12	Placa, 0.015"	18-1713	911839, 3852563	AR	41	Cojinete posición engr. 0.007"	NSS	911664	AR
					41	Cojinete posición engr. 0.010"	18-02065	911665	AR
13	Placa babor	NSS	911837, 3852561	1	41	Cojinete posición engr. 0.012"	18-02066	911666	AR
					41	Cojinete posición engr. 0.015"	18-02067	911667	AR
14	Aro y placa empuje	NSS	910953	4	42	Cojinete cardan	18-1171	983878	1
15	Tuerca	18-3730	912920, 3852648	6	43	Tuerca	18-3770	911937	1
					44	Cono	18-4835	912029	1
16	Arandela	NSS	911833	6	45	Set engranajes, 21:16 (incluye 38 & 45)	18-1600	983825	AR
17	Junta	18-2918	911836, 915840	1	45	Set engranajes, 21:19 (incluye 38 & 45)	18-1602	984012	AR
18	Junta	18-0911	911698	1					
19	Aro tórico	18-7407	911700	1	46	Cojinete cónico	18-1172	983877	1
20	Aro tórico	18-7403	909316	1					
21	Retén bomba agua	18-2068	911701, 915702, 916058, 3853655	1	47	Aro tórico	18-7169	911686	1
					48	Cojinete de apoyo 0.003", verde	18-0227	911678	AR
22	Adaptador	18-4836	911699	1	48	Cojinete de apoyo, 0.004", Naranja	18-0229	911679	AR
23	Tornillo	18-1598	908668, 341013	6					
24	Junta	18-2916	911702	1	48	Cojinete de apoyo, 0.005", Azul	18-02060	911680	AR
25	Platina impulsor	18-3121	911703	1					
26	Impulsor	18-3058	983895, 777128	1	48	Cojinete de apoyo 0.010", Marrón	18-02061	911681	AR
					49	Cojinete engranaje	18-4838	911683	1
27	Alineador tapa bomba agua	18-3145	911844	1	50	Retén aceite	18-2067	911685	1
28	Retén alojamiento bomba agua	18-2541	911704	1	51	Cruceta	18-2338	983880	1
29	Impulsor alojamiento	18-3206	984744	1					
30	Tornillo	NSS	912238	3	52	Eje y alojamiento	18-6399	984264	1
31	Cojinete de apoyo 0.001	18-0209	911669, 911670, 611671, 911672, 911673, 911674, 911675, 911676, 911677	AR	53	Cruceta cardan	18-2104	912214	2
					54	Eje	18-2146	912212	1
					55	Aro tórico	18-7153	911851, 3852565	2
					56	Tapa alojamiento engranaje	18-4838	911845, 986363	1
					57	Indicador aceite	18-8369	914488	1
					58	Aro tórico	18-7116	303067	1
					59	tornillo	18-1599	123018	4
					60	Tapa	18-4750	983967	1
31	Cojinete de apoyo 0.003	18-0211	911669, 911670, 611671, 911672, 911673, 911674, 911675, 911676, 911677	AR	61	Tornillo	18-4749-9	911859, 3852568	3
						Kit alojamiento reparación bomba agua	18-3348	984461, 984744	1

AR Se requiere

NSS No se vende por separado



PARTE SUPERIOR COMPLETA

Ref No.	OE No.	Descripción	Aplicación
18-4804	984770, 986381	Unidad superior Completa, 21: 16 Ratio	5.7L(1986-93), 5.8L(1986-89,1991-93)
18-4805	984771, 986382	Unidad superior Completa, 21: 18 Ratio	2.5L (1986-89),3.0L(1986-93),5.0L(1989-93)
18-4806	984765, 986380	Unidad superior Completa, 21: 19 Ratio	4.3L, 3.0L altura alta OMC Cobra (1986-93)



Tornillos

Ref.	OE No.	Aplicación
18-1598	341013	Para: OMC Cobra (1986-93) sin acoplamiento cónico
18-1599	123018	Para: OMC Cobra (1986-93) sin acoplamiento cónico
18-3135	306643	Colas Cobra
18-4749-9 ^①	3852568	Para ensamblaje tapa: (3 Pack)Para: 2.3L (1987-90), 2.5L (1986), 2.6L (1989), 3.0L (1986-93), 4.3L (1986-93),5.0L (1986-94), 5.7L (1986-92), 5.8L (1989-93), 7.4L (1988)

① Pack de 3, precio por pack



ARANDELA

Ref.	O.E. No.	Tam	Ref.	O.E. No.	Tamaño
18-0207	① 911668	0.010	18-02065	① 911665	0.010
18-0209	① 911669, 911670, 911671, 911672, 911673, 911674, 911675, 911676, 911677	0.001	18-02066	① 911666	0.012
18-0211	① 911669, 911670, 911671, 911672, 911673, 911674, 911675, 911676, 911678	0.003	18-02067	① 911667	0.015
18-0227	① ② 911678	0.003	18-2229	323362	0.003
18-0229	① ③ 911679	0.004	18-2230	323361	0.004
18-1713	① 3852563	0.015	18-2231	314745	0.005
18-1718	⑥ -	Kit			
18-02060	① ④ 911680	0.005			
18-02061	① ⑤ 911681	0.010			
18-02062	① 911662	0.003			
18-02063	① 911663	0.005			

- ① Para: OMC Cobra (1986-93) sin acopl. cónico
- ② verde
- ③ Naranja
- ④ Azul
- ⑤ Marrón
- ⑥ Kit incluye 1 de cada uno de 18-2229, 18-2230 & 18-2231

NOTA: Para tamaños más largos que .010" usar 18-0207 y la combinación apropiada .001"calce (18-0209), y .003" calce (18-0211) Para alcanzar el espesor adecuado.



18-9876
HERRAMIENTA DE CALIBRACIÓN
Reemplaza: 349957



18-4442
HERRAMIENTA ALINEACIÓN

Para verificar alineación de motor en modelos cobra.

ABRAZADERAS ACERO INOXIDABLE ASSI 316

Todos los componentes están fabricados en acero inoxidable 316 grados

Estas pinzas están diseñadas para adaptarse a muchas aplicaciones de 5/16" de 7" manguera diámetro



ABRAZADERAS ACERO INOXIDABLE

Ref #	Tamaño diámetro	Std. #	Ref #	Tamaño diámetro	Std. #
18-710-06-2	5/16" a 7/8"	006	118-710-32-2	1 9/16" a 2 1/2"	032
118-710-10-2	9/16" a 1 1/16"	010	118-710-48-2	2 9/16" a 3 1/2"	048
18-710-12-2	9/16" a 1 1/4"	012	18-710-64-2	2 1/2" a 4 1/2"	064
18-710-16-2	1 1/16" a 1 1/2"	016	18-710-72-2	3" a 5"	072
118-710-20-2	3/4" a 1 3/4"	020	118-710-104-2	5" a 7"	104
118-710-24-2	1 1/16" a 2"	024			



18-2100
COJINETE CARDAN

Reemplaza: 983937

Usar retén 18-8349

Para todos OMC Cobra y Colas King Cobra



18-3763
EJE CAMBIO

Reemplaza: 322941

Para: V-4/V-6, Cobra, Stringer



18-2337
UNIÓN COLA-CARDAN

Reemplaza: 3850814

Para: Todos Cobra 1994-Sup excepto King Cobra



18-6399
ACOPLAMIENTO EJE
Reemplaza: 984264

Para: colas Cobra- 232, 302(1986-90), 252(1986), 262, 350, 460(1989), 432, 434, 502(1986-92), 504(1986-88), 574(1986-92), 584(1989-93), 754(1987-88)



18-2104
CRUCETA CARDAN
Heavy Duty

Reemplaza: 912214, 915716
Para colas OMC Cobra (1986-89) Incluye conexiones rectas y de 90° (Rockwell)



18-2174
CRUCETA CARDAN
Heavy Duty

Reemplaza: 915717, 3850812
Para colas OMC Cobra y King Cobra (1990 & SUP) Incluye conexiones rectas y 90° (Rockwell)



18-2338
CARDAN COMPLETA
Reemplaza: 983880

Para: 1986-93 OMC Cobra



18-2339
CARDAN COMPLETA
Reemplaza: 3852384

Para: Todos Cobra 1994-sup excepto King Cobra



18-2146
ACOPLAMIENTO EJE CRUCETA
Reemplaza: 912212, 3850815

Para: Todos Cobra (1986-Sup)



18-3770
TUERCA
Reemplaza: 911937

Para: 232, 252, 262, 302, 350, 432, 434, 460, 502, 504, 574, 584, 744, 754, (1987-93)

Modelo	Año	Cruceta Cardán #	Cardan. OE #	Eje largo #	Eje largo OE #	Eje corto #	Eje corto OE #
2.3L	1986 ①	18-2338	983880	18-2146	812212	18-6399	984264
3.0L	1986 ①	18-2338	983880	18-2146	812212	18-6399	984264
4.3L	1986 ①	18-2338	983880	18-2146	812212	18-6399	984264
5.7L	1986 ①	18-2338	983880	18-2146	812212	18-6399	984264
2.3L	1987-1988 ①	18-2338	983880	18-2146	912212	18-6399	984264
3.0L	1987-1988 ①	18-2338	983880	18-2146	912212	18-6399	984264
4.3L	1987-1988 ①	18-2338	983880	18-2146	912212	18-6399	984264
5.0L	1987-1988 ①	18-2338	983880	18-2146	912212	18-6399	984264
5.7L	1987-1988 ①	18-2338	983880	18-2146	912212	18-6399	984264
7.5L	1987-1988 ①	18-2338	983880	18-2146	912212	18-6399	984264
2.3L	1989 ①	18-2338	983880	18-2146	912212	18-6399	984264
3.0L	1989 ①	18-2338	983880	18-2146	912212	18-6399	984264
4.3L	1989 ①	18-2338	983880	18-2146	912212	18-6399	984264
5.0L	1989 ①	18-2338	983880	18-2146	912212	18-6399	984264
5.7L	1989 ①	18-2338	983880	18-2146	912212	18-6399	984264
5.8L	1989 ①	18-2338	983880	18-2146	912212	18-6399	984264
7.5L	1989 ①	18-2338	983880	18-2146	912212	18-6399	984264
2.3L	1990 ②	18-2338	983880	18-2146	912212	18-6399	984264
3.0L	1990 ②	18-2338	983880	18-2146	912212	18-6399	984264
4.3L	1990 ②	18-2338	983880	18-2146	912212	18-6399	984264
5.0L	1990 ②	18-2338	983880	18-2146	912212	18-6399	984264
5.7L	1990 ②	18-2338	983880	18-2146	912212	18-6399	984264

APLICACIONES CONTINÚAN EN LA SIGUIENTE PÁGINA

① Used where raw w/p is located on outdrive ② Used where raw w/p is located on engine ③ Excluye Modelo 58FBPMDA, used where raw w/p is located on engine
④ Used where raw w/p is located on engine, incl. Model 58FBPMDA

Modelo	Año	Cruceta Cardán #	Cardan. OE #	Eje largo #	Eje largo OE #	Eje corto #	Eje corto OE #
5.8L	1990 ②	18-2338	983880	18-2146	912212	18-6399	984264
5.7L	1990 ①	18-2338	983880	18-2146	912212	18-6399	984264
7.4L	1990 ①	18-2338	983880	18-2146	912212	18-6399	984264
7.5L	1990 ①	18-2338	983880	18-2146	912212	18-6399	984264
3.0L	1991 ①	18-2338	983880	18-2146	912212	18-6399	984264
4.3L	1991 ①	18-2338	983880	18-2146	912212	18-6399	984264
5.7L	1991 ①	18-2338	983880	18-2146	912212	18-6399	984264
5.8L	1991 ①	18-2338	983880	18-2146	912212	18-6399	984264
7.4L	1991 ②	N/D	986191	18-2146	912212	N/D	914646
3.0L	1992-1993 ①	18-2338	983880	18-2146	912212	18-6399	984264
3.2L	1992-1993 ①	18-2338	983880	18-2146	912212	18-6399	984264
4.3L	1992-1993 ①	18-2338	983880	18-2146	912212	18-6399	984264
5.0L	1992-1993 ①	18-2338	983880	18-2146	912212	18-6399	984264
5.7L	1992-1993 ①	18-2338	983880	18-2146	912212	18-6399	984264
5.8L	1992-1993 ①	18-2338	983880	18-2146	912212	18-6399	984264
3.0L	1992-1993 ②	N/D	986191	18-2146	912212	N/D	914646
3.2L	1992-1993 ②	N/D	986191	18-2146	912212	N/D	914646
4.3L	1992-1993 ②	N/D	986191	18-2146	912212	N/D	914646
5.0L	1992-1993 ②	N/D	986191	18-2146	912212	N/D	914646
5.7L	1992-1993 ②	N/D	986191	18-2146	912212	N/D	914646
5.8L	1992-1993 ②	N/D	986191	18-2146	912212	N/D	914646
7.4L	1992-1993 ②	N/D	986191	18-2146	912212	N/D	914646
8.2L	1992-1993 ②	N/D	986191	18-2146	912212	N/D	914646
3.0L	1994 ③	18-2339	3852384	18-2146	3850815	18-2337	3850814
4.3L	1994 ③	18-2339	3852384	18-2146	3850815	18-2337	3850814
5.0L	1994 ③	18-2339	3852384	18-2146	3850815	18-2337	3850814
5.7L	1994 ③	18-2339	3852384	18-2146	3850815	18-2337	3850814
5.8L	1994 ③	18-2339	3852384	18-2146	3850815	18-2337	3850814
5.8L	1994 ④	N/D	3853937	18-2146	3850815	N/D	3853563
7.4L	1994 ④	N/D	3853937	18-2146	3850815	N/D	3853563
3.0L	1995 ②	18-2339	3852384	18-2146	3850815	18-2337	3850814
4.3L	1995 ②	18-2339	3852384	18-2146	3850815	18-2337	3850814
5.0L	1995 ②	18-2339	3852384	18-2146	3850815	18-2337	3850814
5.8L	1995 ②	18-2339	3852384	18-2146	3850815	18-2337	3850814
7.4L	1995 ②	N/D	3853937	18-2146	3850815	N/D	3853563
3.0L	1996 ②	18-2339	3852384	18-2146	3850815	18-2337	3850814
4.3L	1996 ②	18-2339	3852384	18-2146	3850815	18-2337	3850814
5.0L	1996 ②	18-2339	3852384	18-2146	3850815	18-2337	3850814
5.7L	1996 ②	18-2339	3852384	18-2146	3850815	18-2337	3850814
5.8L	1996 ②	18-2339	3852384	18-2146	3850815	18-2337	3850814
7.4L	1996 ②	18-2339	3852384	18-2146	3850815	18-2337	3850814
3.0L	1997 ②	18-2339	3852384	18-2146	3850815	18-2337	3850814
4.3L	1997 ②	18-2339	3852384	18-2146	3850815	18-2337	3850814
5.7L	1997 ②	18-2339	3852384	18-2146	3850815	18-2337	3850814
7.4L	1997 ②	18-2339	3852384	18-2146	3850815	18-2337	3850814
3.0L	1998 ②	18-2339	3852384	18-2146	3850815	18-2337	1850814
4.3L	1998 ②	18-2339	3852384	18-2146	3850815	18-2337	1850814
5.0L	1998 ②	18-2339	3852384	18-2146	3850815	18-2337	1850814
5.7L	1998 ②	18-2339	3852384	18-2146	3850815	18-2337	1850814
7.4L	1998 ②	18-2339	3852384	18-2146	3850815	18-2337	1850814
8.2L	1998 ②	18-2339	3852384	18-2146	3850815	18-2337	1850814
43APHUB	1995	18-2339	3852384	18-2146	3850815	18-2337	3850814
43FAPNCA	1996	18-2339	3852384	18-2146	3820815	18-2337	3850814
43FBPBYC	1998	18-2339	3852384	18-2146	3820815	18-2337	3850814
43FBPLKD	1997	18-2339	3852384	18-2146	3820815	18-2337	3850814
43FBPNCS	1996	18-2339	3852384	18-2146	3820815	18-2337	3850814

APLICACIÓN CONTINUA EN LA SIGUIENTE PÁGINA

① Used where raw w/p is located on outdrive

② Used where raw w/p is located on engine

③ Excluye modelo 58FBDPMDA, used where raw w/p is located on engine

④ Used where raw w/p is located on engine, incl. Model 58FBDPMDA

Modelo	Año	Cruceta Cardán #	Cardan. OE #	Eje largo #	Eje largo OE #	Eje corto #	Eje corto OE #
50FBPBYC	1998	18-2339	3852384	18-2146	3820815	18-2337	3850814
50FACPMDA	1994	18-2339	3852384	18-2146	3820815	18-2337	3850814
50FACPMDM	1994	18-2339	3852384	18-2146	3820815	18-2337	3850814
50FAGPMDA	1994	18-2339	3852384	18-2146	3820815	18-2337	3850814
50FAGPMDM	1994	18-2339	3852384	18-2146	3820815	18-2337	3850814
50FAPHUB	1995	18-2339	3852384	18-2146	3850815	18-2337	3850814
50FAPHUE	1995	18-2339	3852384	18-2146	3850815	18-2337	3850814
50FAPNCA	1996	18-2339	3852384	18-2146	3820815	18-2337	3850814
50FAPNCS	1996	18-2339	3852384	18-2146	3820815	18-2337	3850814
50FBPBYC	1998	18-2339	3852384	18-2146	3820815	18-2337	3850814
57FAPLKD	1997	18-2339	3852384	18-2146	3850815	18-2337	3850814
57FAPNCA	1996	18-2339	3852384	18-2146	3850815	18-2337	3850814
57FAPNCS	1996	18-2339	3852384	18-2146	3850815	18-2337	3850814
57FCPBYC	1998	18-2339	3852384	18-2146	3820815	18-2337	3850814
57FCPBYD	1998	18-2339	3852384	18-2146	3820815	18-2337	3850814
57FCPLKD	1997	18-2339	3852384	18-2146	3850815	18-2337	3850814
57FDPLKD	1997	18-2339	3852384	18-2146	3850815	18-2337	3850814
58FACPMDA	1994	18-2339	3852384	18-2146	3820815	18-2337	3850814
58FACPMDM	1994	18-2339	3852384	18-2146	3820815	18-2337	3850814
58FAGPMDA	1994	18-2339	3852384	18-2146	3820815	18-2337	3850814
58FAGPMDM	1994	18-2339	3852384	18-2146	3820815	18-2337	3850814
58FAPHUB	1995	18-2339	3852384	18-2146	3820815	18-2337	3850814
58FAPHUE	1995	18-2339	3852384	18-2146	3820815	18-2337	3850814
58FBDMDA	1994	18-2339	3852384	18-2146	3820815	18-2337	3850814
58FBPHUB	1995	18-2339	3852384	18-2146	3820815	18-2337	3850814
58FBPHUE	1995	18-2339	3852384	18-2146	3820815	18-2337	3850814
58FBPNCA	1996	18-2339	3852384	18-2146	3820815	18-2337	3850814
58FBPMDA	1994	18-2339	3852384	18-2146	3820815	18-2337	3850814
58FCPNCA	1996	18-2339	3852384	18-2146	3820815	18-2337	3850814
58FCPNCS	1996	18-2339	3852384	18-2146	3820815	18-2337	3850814
74FEHUB	1995	18-2339	3852384	18-2146	3820815	18-2337	3850814
74FFPNCA	1996	18-2339	3852384	18-2146	3850815	18-2337	3850814
74FGPLKD	1997	18-2339	3852384	18-2146	3820815	18-2337	3850814
74FGPNCS	1996	18-2339	3852384	18-2146	3850815	18-2337	3850814
74FHPYC	1998	18-2339	3852384	18-2146	3820815	18-2337	3850814
74FHPBYC	1998	18-2339	3852384	18-2146	3820815	18-2337	3850814
74FJPBYC	1998	18-2339	3852384	18-2146	3820815	18-2337	3850814
74FJPYC	1998	18-2339	3852384	18-2146	3820815	18-2337	3850814
74FJPBYD	1998	18-2339	3852384	18-2146	3820815	18-2337	3850814
74FJPYD	1998	18-2339	3852384	18-2146	3820815	18-2337	3850814
82FCPBYC	1998	18-2339	3852384	18-2146	3820815	18-2337	3850814
302CCPMDA	1994	18-2339	3852384	18-2146	3820815	18-2337	3850814
302CGPMDA	1994	18-2339	3852384	18-2146	3820815	18-2337	3850814
302CMBYBYC	1998	18-2339	3852384	18-2146	3820815	18-2337	3850814
302CMBYBYM	1998	18-2339	3852384	18-2146	3820815	18-2337	3850814
302CMHUB	1995	18-2339	3852384	18-2146	3820815	18-2337	3850814
302CMLKD	1997	18-2339	3852384	18-2146	3850815	18-2337	3850814
302CMNCA	1996	18-2339	3852384	18-2146	3820815	18-2337	3850814
302CMNCS	1996	18-2339	3852384	18-2146	3820815	18-2337	3850814
302CPBYC	1998	18-2339	3852384	18-2146	3820815	18-2337	3850814
302CPBYM	1998	18-2339	3852384	18-2146	3820815	18-2337	3850814
302CPHUB	1995	18-2339	3852384	18-2146	3820815	18-2337	3850814
302CPLKD	1997	18-2339	3852384	18-2146	3850815	18-2337	3850814
302CPNCA	1996	18-2339	3852384	18-2146	3820815	18-2337	3850814
302CPNCS	1996	18-2339	3852384	18-2146	3820815	18-2337	3850814
302DCMMDA	1994	18-2339	3852384	18-2146	3820815	18-2337	3850814
302DGMMDA	1994	18-2339	3852384	18-2146	3820815	18-2337	3850814
432ACMMDA	1994	18-2339	3852384	18-2146	3820815	18-2337	3850814

APLICACIONES CONTINÜAN EN LA SIGUIENTE PÁGINA

- ① Used where raw w/p is located on outdrive ② Used where raw w/p is located on engine ③ Excluye Modelo 58FBPMDA, used where raw w/p is located on engine
 ④ Used where raw w/p is located on engine, incl. Modelo 58FBPMDA

Modelo	Año	Cruceta Cardán #	Cardan. OE #	Eje largo #	Eje largo OE #	Eje corto #	Eje corto OE #
432ACPMDA	1994	18-2339	3852384	18-2146	3820815	18-2337	3850814
432AGMMDA	1994	18-2339	3852384	18-2146	3820815	18-2337	3850814
432AGPMDA	1994	18-2339	3852384	18-2146	3820815	18-2337	3850814
432APNCA	1996	18-2339	3852384	18-2146	3820815	18-2337	3850814
432BPLKD	1997	18-2339	3852384	18-2146	3820815	18-2337	3850814
432BPNCs	1996	18-2339	3852384	18-2146	3820815	18-2337	3850814
502APHUB	1995	18-2339	3852384	18-2146	3820815	18-2337	3850814
502APHUE	1995	18-2339	3852384	18-2146	3820815	18-2337	3850814
432ACMMDA	1994	18-2339	3852384	18-2146	3820815	18-2337	3850814
432ACPMDA	1994	18-2339	3852384	18-2146	3820815	18-2337	3850814
432AGMMDA	1994	18-2339	3852384	18-2146	3820815	18-2337	3850814
432AGPMDA	1994	18-2339	3852384	18-2146	3820815	18-2337	3850814
432BPBYC	1998	18-2339	3852384	18-2146	3820815	18-2337	3850814
432BPLKD	1997	18-2339	3852384	18-2146	3820815	18-2337	3850814
434APNCA	1996	18-2339	3852384	18-2146	3820815	18-2337	3850814
434BPBYC	1998	18-2339	3852384	18-2146	3820815	18-2337	3850814
434BPLKD	1997	18-2339	3852384	18-2146	3820815	18-2337	3850814
434BPNCs	1996	18-2339	3852384	18-2146	3820815	18-2337	3850814
502ACPMDA	1994	18-2339	3852384	18-2146	3820815	18-2337	3850814
502AGPMDA	1994	18-2339	3852384	18-2146	3820815	18-2337	3850814
502APHUB	1995	18-2339	3852384	18-2146	3850815	18-2337	3850814
502APHUE	1995	18-2339	3852384	18-2146	3850815	18-2337	3850814
502APNCA	1996	18-2339	3852384	18-2146	3820815	18-2337	3850814
502APNCs	1996	18-2339	3852384	18-2146	3820815	18-2337	3850814
502BPBYC	1998	18-2339	3852384	18-2146	3820815	18-2337	3850814
572ACPMDA	1994	18-2339	3852384	18-2146	3820815	18-2337	3850814
572AGPMDA	1994	18-2339	3852384	18-2146	3820815	18-2337	3850814
572BPBYC	1998	18-2339	3852384	18-2146	3820815	18-2337	3850814
572BPLKD	1997	18-2339	3852384	18-2146	3820815	18-2337	3850814
572BPLKR	1997	18-2339	3852384	18-2146	3820815	18-2337	3850814
572BPNCs	1996	18-2339	3852384	18-2146	3820815	18-2337	3850814
574BPLKD	1997	18-2339	3852384	18-2146	3820815	18-2337	3850814
584ACPMDA	1994	18-2339	3852384	18-2146	3820815	18-2337	3850814
584AGPMDA	1994	18-2339	3852384	18-2146	3820815	18-2337	3850814
584APHUB	1995	18-2339	3852384	18-2146	3820815	18-2337	3850814
584APHUE	1995	18-2339	3852384	18-2146	3820815	18-2337	3850814
584APNCA	1996	18-2339	3852384	18-2146	3820815	18-2337	3850814
584APNCs	1996	18-2339	3852384	18-2146	3820815	18-2337	3850814
744DCPMDM	1994	18-2339	3852384	18-2146	3820815	18-2337	3850814
744DCPMDA	1994	18-2339	3852384	18-2146	3820815	18-2337	3850814
744DDPMDA	1994	18-2339	3852384	18-2146	3820815	18-2337	3850814
744DDPMDM	1994	18-2339	3852384	18-2146	3820815	18-2337	3850814
744GPMMDA	1994	18-2339	3852384	18-2146	3820815	18-2337	3850814
744GPMMDM	1994	18-2339	3852384	18-2146	3820815	18-2337	3850814
744JPMMDA	1994	18-2339	3852384	18-2146	3820815	18-2337	3850814
744JPMMDM	1994	18-2339	3852384	18-2146	3820815	18-2337	3850814
744DPHUB	1995	18-2339	3852384	18-2146	3820815	18-2337	3850814
744EPNCA	1996	18-2339	3852384	18-2146	3850815	18-2337	3850814
744FPLKD	1997	18-2339	3852384	18-2146	3850815	18-2337	3850814
744FPNCs	1996	18-2339	3852384	18-2146	3850815	18-2337	3850814

③ Excludes Model 58FBPMDA, used where raw w/p is located on engine ④ Used where raw w/p is located on engine, incl. Model 58FBPMDA

**18-2772-1
KIT TRANSOM**
Para: Drives SX Cobra con embrague cónico



**18-2771
KIT FUELLES**
Reemplaza: 3854270
Para: OMC Cobra sin embrague cónico



— CONTIENE —

Ref #	Descripción	O.E. #	Cant.
18-2100	Cojinete	3853807	1
18-2765	Fuelle	3854127	1
18-1074	Fuelle	3850426-2	1
18-2996	Retén	3852560, 911823	1
18-710-64-2	Abrazadera	853012-3	1

— CONTIENE —

Ref #	Descripción	O.E. #
18-2613	Kit juntas	—
18-2765	Fuelle	983973, 987467
18-2764	Fuelle escape	914036
18-2763	Fuelle cable	911826
18-2100	Cojinete cardan	983937
18-710-64-2	Abrazadera	—



18-2128
SOPORTE CENTRAL
Reemplaza:
912213, 3850813
Para todas las unidades OMC
Cobra



18-2745
TUBO ESCAPE
Reemplaza: 912374
Para 5.7L & 7.5L (1986 &
posteriores)



18-1074
FUELLE ESCAPE
D.I. 2 5/8" x O.D. 3" x L
7.5"
Reemplaza: 3850426
Todos los modelos con acopla-
miento cónico (1994-Sup) que no
llevan tubo escape



18-2763
**FUELLE CABLE
CAMBIO**
Reemplaza: 911826
TODOS COBRA



18-2764
FUELLE ESCAPE
Reemplaza: 914036
Para modelos Cobra (1986-93)



18-2765
FUELLE TRANSMISIÓN
D.I. 3 1/2" x O.D. 4" x L 6"
Reemplaza: 983973,
987467, 3854127
Para modelos Cobra (1986-93)



18-21754
DAMPER
Reemplaza: 986232, 984537
Para: 7.5L / 460 King Cobra 1987-90



18-21751
DAMPER
Reemplaza: 3853962,
983902, 986338
Para: 2.5L (1986), 3.0L (1986-90), (4.3L,
5.0L, 5.7L) (1986) KW & KWB sólo sufijo,
7.4L (1990-98), 8.2L (1992-93, 1998)



18-21752-1
DAMPER
Reemplaza: 3858437, 984290,
986120, 3853917
Para: 4.3L (1986-98), 5.0L (1986-88,
1998) 5.7 (1986-92, 1994, 1996-98)



18-21753
DAMPER
Reemplaza: 3853862
Para: 5.0L & 5.8L (1989-96)



18-21755
DAMPER
Reemplaza: 984629
2.3L Cobra



18-2533
RETÉN TRANSOM
Reemplaza: 911797



18-2767
RETÉN TRANSOM
16 manguera
Reemplaza: 313080
(1967-77) 120 HP y SUP



18-2768
RETÉN TRANSOM
22 manguera
Reemplaza: 909527
(1978-86) — Todos



18-2245-1
CONJUNTO CABLE INVERSOR
Reemplaza: 987661
Cable: 68" • Funda: 58 1/2"
Para: 1988-1993 OMC Cobra (excepto
King)
Sin el embrague cónico



18-2246
CONJUNTO CABLE INVERSOR
Reemplaza: 987678
Cables: 59"
Para: King Cobra



18-2178
KIT ENGRANAJE
(1973-86)
— CONTIENE —

Ref #	Desc.	O.E. #	Cant.	Ref #	Desc.	O.E. #	Cant.
18-7121	Aro tórico	308621	1	18-3725	Tuerca bloq	908064	2
18-4251	Conexión	908062	2	18-7401	Aro tórico	908383	1
18-2176	Engranaje	908063	1	18-2071	Retén	981195	2
18-2177	Engranaje	908069	1	18-2072	Retén	981196	2

 <p>18-2176 ENGRANAJE (Aloj.intermedio) Reemplaza: 908063 (1973-86)</p>	 <p>18-2177 ENGRANAJE (Aloj.superior) Reemplaza: 908069 1973-86</p>	 <p>18-3769 TUERCA PIÑÓN Reemplaza: 911753 Para: 115 (1994-97), 232 (1987-90), 252 (1986), 262, 350, 460 (1989), 302, 574 (1986-92), 432 (1986-93), 502 (1988-93), 504, 754 (1986-88), .584 (1989-93), 744 (1988), 90 Jet (1994-95)</p>	 <p>18-3719 TUERCA PIÑÓN Reemplaza: 314730 (⁵/₈ - 18)</p>	
<p>PACK. DE 5</p>  <p>18-3725 18-3725-9^① TUERCA Reemplaza: 908064</p>	<p>PACK. DE 2</p>  <p>18-3731 18-3731-9^① TUERCA Reemplaza: 907866 ³/₄ - 16</p>	<p>PKG. OF 5</p>  <p>18-4251 18-4251-9^① TAPÓN Reemplaza: 908062 O.D. 1.748</p>	 <p>18-4835 CONO Reemplaza: 912029 Para: OMC Cobra (1986-93) sin acoplamiento cónico</p>	 <p>18-1154 COJINETE A BOLAS Reemplaza: 377139</p>
 <p>18-1161 COJINETE Reemplaza: 983891</p>	 <p>18-1170 COJINETE PIÑÓN INFERIOR Reemplaza: 983892</p>	 <p>18-1171 COJINETE TRANSMISIÓN Reemplaza: 983878</p>	 <p>18-1172 COJINETE Reemplaza: 983877 Para: 1986-95 Cobra</p>	
 <p>18-1158 COJINETE Reemplaza: 387247</p>	 <p>18-1350 COJINETE Reemplaza: 379504</p>	 <p>18-1351 COJINETE Reemplaza: 382407 COBRA</p>	 <p>18-1117 COJINETE PIÑÓN Reemplaza: 387817</p>	 <p>18-1357 COJINETE PIÑÓN Reemplaza: 384195 COBRA</p>
 <p>18-1358 COJINETE ENGRANA- JE REVERSO Reemplaza: 389039 COBRA</p>	 <p>18-1365 COJINETE EMPUJE Reemplaza: 387656 COBRA EJE TRANSMISIÓN</p>	 <p>18-1366 COJINETE EMPUJE Reemplaza: 382408 COBRA ENGRANAJE REVERSO</p>	 <p>18-1370 COJINETE EMPUJE ENGRANAJE AVANTE Reemplaza: 389042</p>	 <p>18-1371 COJINETE EMPUJE AVANTE Reemplaza: 385043 COBRA</p>

① Precio por pack

SERIES OMC 400 & 800 COJINETES CAJA ENGRANAJES

HP	Año	Cojinete piñón	Cojinete transmisión	Cojinete Diabolo	Cojinete diabolo externo	Cojinete Empuje avante	Cojinete empuje Reverso	Alojamiento Cojinete
120	1978-81	18-1357	18-1365	18-1350	18-1351	18-1371	18-1366	—
2.5L	1982-86	18-1357	18-1365	18-1350	18-1351	18-1371	18-1366	18-1351
140	1978-81	18-1357	18-1365	18-1350	18-1351	18-1371	18-1366	—
3.0L	1982-86	18-1357	18-1365	18-1350	18-1351	18-1371	18-1366	18-1351
185/3.8L	1978-85	18-1117	18-1365	18-1158	18-1351	18-1370	18-1366	18-1358
4.3L	1985-86	18-1117	18-1365	18-1158	18-1351	18-1370	18-1366	18-1358
200/5.0L	1979-86	18-1117	18-1365	18-1158	18-1351	18-1370	18-1366	18-1358
225	1978	18-1117	18-1365	18-1158	18-1351	18-1370	18-1366	18-1358
230/530L	1979-86	18-1117	18-1365	18-1158	18-1351	18-1370	18-1366	18-1358
240	1978	18-1117	18-1365	18-1158	18-1351	18-1370	18-1366	18-1358
250	1979	18-1117	18-1365	18-1158	18-1351	18-1370	18-1366	18-1358
260/5.7L	1979-86	18-1117	18-1365	18-1158	18-1351	18-1370	18-1366	18-1358

OMC COBRA COJINETES

Modelo	Litro	Año	Cojinete piñón	Cojinetes transmisión	Cojinete diabolo	Cojinete diabolo Externo	Cojinete empuje avante	Cojinete empuje reverso	Alojamiento Cojinete
2.3L	2.3L	1987	18-1357	18-1365	18-1350	18-1351	18-1371	18-1366	18-1351
2.3L	2.3L	1988-1990	18-1357	18-1365	18-1350	18-1351	18-1371	18-1366	N/D
2.5L	2.5L	1986	18-1357	18-1365	18-1350	18-1351	18-1371	18-1366	18-1351
3.0L	3.0L	1986-1987	18-1357	18-1365	18-1350	18-1351	18-1371	18-1366	18-1351
3.0L	3.0L	1988-1989	18-1357	18-1365	18-1350	18-1351	18-1371	18-1366	N/D
3.0L	3.0L	1990-1991	18-1117	18-1365	18-1158	18-1351	18-1370	18-1366	N/D
3.0L	3.0L	1992-1993	18-1117	18-1365	N/D	18-1351	18-1370	18-1366	N/D
3.0L HO	3.0L	1992-1993	18-1117	18-1365	N/D	18-1351	18-1370	18-1366	N/D
4.3L	4.3L	1986-1987	18-1117	18-1365	18-1158	18-1351	18-1370	18-1366	18-1358
4.3L	4.3L	1988-1991	18-1117	18-1365	18-1158	18-1351	18-1370	18-1366	N/D
4.3L	4.3L	1992-1993	18-1117	18-1365	N/D	18-1351	18-1370	18-1366	N/D
4.3L HO	4.3L	1992-1993	18-1117	18-1365	N/D	18-1351	18-1370	18-1366	N/D
5.0L	5.0L	1986-1987	18-1117	18-1365	18-1158	18-1351	18-1370	18-1366	18-1358
5.0L	5.0L	1988-1991	18-1117	18-1365	18-1158	18-1351	18-1370	18-1366	N/D
5.0L	5.0L	1992-1993	18-1117	18-1365	N/D	18-1351	18-1370	18-1365	N/D
5.0L HO	5.0L	1992-1993	18-1117	18-1365	N/D	18-1351	18-1370	18-1365	N/A
5.7L	5.7L	1986-1987	18-1117	18-1365	18-1158	18-1351	18-1370	18-1366	18-1358
5.7L	5.7L	1988-1991	18-1117	18-1365	N/D	18-1351	18-1370	18-1365	N/D
5.7L	5.7L	1992-1993	18-1117	18-1365	N/D	18-1351	18-1370	18-1366	N/D
5.8L	5.8L	1989-1991	18-1117	18-1365	N/D	18-1351	18-1370	18-1366	N/D
5.8L	5.8L	1992-1993	18-1117	18-1365	N/D	18-1351	18-1370	18-1366	N/D



18-0195
ARANDELA EMPUJE
Reemplaza: 314731
COBRA



18-0198
ARANDELA DE EMPUJE
Reemplaza: 324766

PACK. DE 2

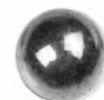

18-2243
18-2243-9^①
BOLA RETENCIÓN
Reemplaza: 316506
Para: Caja engranajes V-4 & V-6
OMC colas 400 Series (1978-79);
800 Series (1978)



18-1501
BOLA RETENCIÓN
Reemplaza: 160084
Para: Colas Cobra (1980& anteriores)



18-1732
RETENEDOR EJE TRANSMISIÓN
Reemplaza: 338504
Para: eje transmisión V4 & V6



18-1701
EJE INFERIOR TRANSMISIÓN
Reemplaza: 911693
Para: Colas Cobra 262, 302, 350,
432, 434, 502, 504, 574, 584



18-2183
EJE TRANSMISIÓN
Reemplaza: 909121

① Precio por pack



18-2184
EJE TRANSMISIÓN
 Reemplaza: 908087



18-2185
EJE TRANSMISIÓN
 Reemplaza: 909753



18-2186
EJE TRANSMISIÓN
 Reemplaza: 982424
 800 transmisión



18-2187
EJE HÉLICE
 Reemplaza: 395209
 Cobra & últimos modelos transmisión
 800



18-2251
EJE HÉLICE
 Reemplaza: 435022, 433017, 436740



18-2252
EJE HÉLICE
 Reemplaza: 387818, 436888



18-2216
PIÑÓN EMBRAGUE
 Reemplaza: 337772, 337774,
 334516, 336562, 910995



18-2220
PIÑÓN EMBRAGUE
 Reemplaza: 323664, 320630



18-2383
PIÑÓN EMBRAGUE
 Reemplaza: 914716, 915272
 Para: 3.0L (GM), 4.3L (GM), 5.0L (Ford), 5.7L (Ford),
 5.8L (Ford) (1990-91)



18-2218
PIÑÓN MARCHA ADELANTE
 Reemplaza: 434063, 987966,
 985050, 436746



18-2219
PIÑÓN MARCHA ATRAS
 Reemplaza: 333077,
 317838, 340490



18-1600
KIT SUPERIOR ENGRANAJE
 con cojinete
 Reemplaza: 983825
 Para: 5.7, 5.8L V-8 Cobra transmisión (21:16 ratio)



18-1601
KIT ENGRANAJE SUPERIOR
 con cojinete
 Reemplaza: 983826
 Para: Motor 5.0L V-8 -Cobra transmisión (21:18 ratio)



18-1602
KIT ENGRANAJES SUPERIOR
 Reemplaza: 984012
 Para: 4.3L V-6 motor-Cobra transmisión (21:19 ratio)

APLICACIONES EJES/ENGRANAJES

Modelo	Año	Cojinete soporte eje	Eje bomba agua corto/largo	Eje transmisión	Eje hélice	Engranaje Avante	Engranaje Reverso	Embrague deslizante
100 hasta 165	1973	—	18-2185	—	—	—	—	—
120 hasta 190	1974-75	—	18-2185	—	—	—	—	—
120 hasta 235 ⑥	1976-77	—	18-2184	—	—	—	—	—
120 hasta 190 ⑤	1976	—	18-2185	—	—	—	—	—
120/140 ⑤	1977	—	18-2185	—	—	—	—	—
120/140	1978-81	18-2183	18-2185	—	18-2252	—	—	18-2220
120 hasta 235 ⑥	1977	—	18-2184	—	—	—	—	—
175/190/235 ⑤	1977	18-2183	18-2185	—	—	—	—	—
185	1978	18-2183	18-2185	18-2186	—	—	—	—
185	1980-81	18-2183	18-2185	18-2186	—	—	—	—
200	1979	18-2183	18-2185	18-2186	—	—	—	—
200	1980-81	18-2183	18-2185	18-2186	—	—	—	—
225/245	1973-75	—	18-2184	—	—	—	—	—
225	1978	18-2183	18-2185	18-2186	—	—	—	—
225	1979	—	—	18-2186	—	—	—	—
225	1980	—	—	18-2186	—	—	—	—
225	1981	—	—	18-2186	—	—	—	—
230	1979	18-2183	18-2185	18-2186	—	—	—	—
230	1980-81	18-2183	18-2185	18-2186	—	—	—	—
235	1975	18-2183	18-2185	—	—	—	—	—
235 ⑤	1976-77	18-2183	18-2185	—	—	—	—	—
240	1978	18-2183	18-2185	18-2186	—	—	—	—
240	1979	—	—	18-2186	—	—	—	—
240	1980-81	—	—	18-2186	—	—	—	—
250	1979	18-2183	18-2185	18-2186	—	—	—	—
260	1979	18-2183	18-2185	18-2186	—	—	—	—
260	1980-81	18-2183	18-2185	—	—	—	—	—
262	1989	—	—	—	18-2187	—	—	—
2.3/3.0	1987-89	—	—	—	18-2252	—	18-2219	—
2.3	1990	—	—	—	18-2252	—	—	—
2.5	1986	18-2183	18-2185	—	18-2252	—	18-2219	—
2.5	1982-87	18-2183	18-2185	—	18-2252	18-2218	18-2219	—
350 ③	1988-89	—	—	—	18-2187	18-2218	—	—
3 ①	1982-86	18-2183	18-2185	—	18-2252	18-2218	18-2219	18-2216
3.0/4.3 ③	1990-91	—	—	—	18-2187	—	—	18-2383
3.0/4.3	1992-93	—	—	—	18-2251	—	—	18-2383
3.0 H.O.	1990-91	—	—	—	18-2187	—	—	18-2383
3.0 H.O.	1992-93	—	—	—	18-2251	—	—	18-2383
3.8	1982-86	18-2183	18-2185	18-2186	18-2187	—	—	18-2216
460 ③	1988-89	—	—	—	18-2187	—	—	18-2216
4.3 ①	1985-86	18-2183	18-2185	18-2186	18-2187	—	—	18-2216
4.3 ②	1986-87	—	—	—	18-2187	—	—	—
4.3 ③	1988-91	—	—	—	18-2187	—	—	18-2383 ⑨
4.3 H.O.	1990-91	—	—	—	18-2187	—	—	18-2383
4.3 H.O.	1992-93	—	—	—	18-2251	—	—	18-2383
5.0/5.7	1982-83	18-2183	18-2185	18-2186	—	—	—	18-2216
5.0/5.7 ①	1984-86	18-2183	18-2185	18-2186	18-2187	—	—	18-2216
5 ②	1986-87	—	—	—	18-2187	—	—	—
5	1988	—	—	—	18-2187	—	—	—
5 ③	1988-91	—	—	—	18-2187	—	—	18-2383 ⑨
5.0/5.7	1992	—	—	—	18-2251	—	—	18-2383
5.0 H.O.	1990-91	—	—	—	18-2187	—	—	18-2383
5.0 H.O.	1992-93	—	—	—	18-2251	—	—	18-2383
5.7	1987-88	—	—	—	18-2187	—	—	—
5.7 ③	1988-89	—	—	—	18-2187	—	—	—
5.7 ③ ③	1990-92	—	—	—	18-2187	—	—	18-2383
5.8 ③	1989-90	—	—	—	18-2187	—	—	18-2383 ⑨
5.8	1991	—	—	—	18-2187	—	—	18-2383
5.8	1992-93	—	—	—	18-2251	—	—	18-2383
7.5	1987	—	—	—	18-2187	—	—	18-2216

① Excepto Cobra
② Cobra

③ Rotación derecha
⑤ Perfil bajo

⑥ Perfil alto
⑧ Excepto modelos L.E

⑨ Sólo modelos 1990-93



**18-1702
RODILLO DIABOLO**
Reemplaza: 438039, 5000074
Para: 1 3/16" diámetro eje-Cobra transmisión (1986-90) Para montajes stringer 2.5L & 3.0L (1978-85)



**18-1703
RODILLO DIABOLO**
Reemplaza: 434400, 435096, 438040, 5000363, 5004257
Para: 1 1/4" diámetro eje hélice Cobra transmisión (1991-93)



18-4828
COJINETE PIÑÓN
 Reemplaza: 911750
 Para: OMC Cobra (1986-93) sin alojamiento cónico



18-1099
ALOJAMIENTO COJINETE
 Reemplaza: 982422
 Para: Colas OMC Stringer-120, 140, 170, 200, 230, 260, (1981), 252, 302, 382, 502, 504 & 574 (1982-85), 432 (1985)



18-1343
COJINETE RETENEDOR
 Reemplaza: 333957
 Para: Cobra transmisión & V-6



18-0655
VARILLA DE CAMBIO
 Reemplaza: 914736
 3.0L (1990-1993), 4.3L, 5.0L, 5.7L, 5.8L (1986-1993)



18-0647
VARILLA DE CAMBIO
 Reemplaza: 986658
 3.0L (1990-1993), 4.3L, 5.0L, 5.7L, 5.8L (1986-1993)



18-0652
TERMINAL VARILLA DE CAMBIO
 Reemplaza: 914723
 3.0L (1990-1993), 4.3L, 5.0L, 5.7L, 5.8L (1986-1993)



18-0653
TORNILLO, VARILLA CAMBIO
 Reemplaza: 308825
 3.0L (1990-1993), 4.3L, 5.0L, 5.7L, 5.8L (1986-1993)



18-0654
TUERCA, VARILLA CAMBIO
 Reemplaza: 914743
 3.0L (1990-1993), 4.3L, 5.0L, 5.7L, 5.8L (1986-1993)



18-3766
BASE CAMBIO
 Reemplaza: 334163
 Para: V-4/V-6, Cobra, Stringer



18-3610
TUERCA RETENEDOR
 Reemplaza: 911752
 Para: OMC Cobra (1986-93) sin alojamiento cónico



18-3768
TUERCA TAPA
 Reemplaza: 911751
 Para: Colas Cobra 115 (1994-97), 232 (1987-90), 252 (1986) 262 (1989), 302 (1987)



18-1500
REJILLA ADMISIÓN
 Reemplaza: 337778
 Para: 100, 120, 125, 140, 150, 175, 200, 225 (1993) (OMC Cobra & V6)



18-4750
TAPA
 Reemplaza: 983967
 Para: 2.3L (1987-90), 2.5L (1986), 2.6L (1989), 3.0L (1986-93), 4.3L (1986-93), 5.0L (1986-94), 5.7L (1986-92), 5.8L (1989-93), 7.4L (1988)



18-1714
PASADOR
 Reemplaza: 313448
 Para: 50-85, 100, 135, 140, 150, 175, 200, 235 (1969-82) (OMC Stringer transmisión)



18-2399
MUELLE TRINQUETE
Reemplaza: 324369
Para: V-4 & V-6



18-4222
ARANDELA
Reemplaza: 318841



18-4223
ARANDELA
Reemplaza: 333592



18-4228
ESPACIADOR HÉLICE
Reemplaza: 315810



18-4194
ESPACIADOR HÉLICE
Reemplaza: 3852350
Para: 1994 King Cobra Unidades inferiores



18-4231
ESPACIADOR HÉLICE
Reemplaza: 320570

PKG. OF 5



18-3705
18-3705-9①
TUERCA HÉLICE
Reemplaza: 314503



18-3708-1
TUERCA HÉLICE Y RETENEDOR
Reemplaza: 398042



18-3730
TUERCA MONTAJE FUERABORDA
Reemplaza: 3852648
Para: Cobra & King Cobra 1987-94

② **18-3733D** 



18-3733
KIT TUERCAS HÉLICE
Para: SX Cobra

② **18-3715D** 



18-3715
KIT TUERCAS HÉLICE
— CONTIENE —

Ref #	O.E. #	Descripción
18-3708-1	398042	tuerca hélice/Retenedor
18-3741	309955	Aguja
18-4231	320570	Espaciador hélice

② **18-3716D** 



18-3716
KIT TUERCAS HÉLICE
Reemplaza: 175267
— CONTIENE —

Ref #	O.E. #	Descripción
18-3705	314503	Tuerca hélice
18-3742	314502	Aguja
18-4238	315810	Espaciador hélice



18-4444
LLAVE HÉLICE
TODO LOS COBRA



18-2156
EJE DE TILT
Reemplaza: 980183
I/O 1964-86
EXCEPTO COBRA

PKG. OF 10



PASADORES

18-3741 18-3741-9① 309955	18-3742 18-3742-9① 314502
---	---

Reemplaza:



18-9098
BLOQUEADOR COLA
Reemplaza: 174448
juego de 2
Para todas las transmisiones Cobra

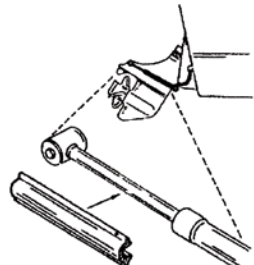



APLICACIONES COMIENZAN EN LA PRÓXIMA PÁGINA

① Precio por pack

② Las referencias acabadas en "D" son envasadas en blister - referencias normales no envasadas

TUERCA/ESPACIADOR/ARANDELA/PASADOR/APLICACIÓN TUERCA

Modelo	Año	Tuerca	Espaciador	Arandela	Aguja Pasador	Kit tuerca hélice	Modelo	Año	Tuerca	espaciador	Arandela	Aguja Pasador	Kit Tuerca
120	1978-81	18-3705	18-4228	18-4222	18-3742	18-3716	460	1989-90	18-3708-1	18-4231	18-4223	18-3741	18-3715
140	1978-81	18-3705	18-4228	18-4222	18-3742	18-3716	502	1992	18-3708-1	18-4231	18-4223	18-3741	18-3715
185	1978-80	18-3708-1	18-4231	18-4223	18-3741	18-3715	2.3	1987-90	18-3705	18-4228	18-4222	18-3742	18-3716
200	1979-81	18-3708-1	18-4231	18-4223	18-3741	18-3715	2.5	1982-86	18-3705	18-4228	18-4222	18-3742	18-3716
225	1978	18-3708-1	18-4231	18-4223	18-3741	18-3715	3	1982-89	18-3705	18-4228	18-4222	18-3742	18-3716
230	1979	18-3708-1	18-4231	18-4223	18-3741	18-3715	3	1990-92	18-3708-1	18-4231	18-4223	18-3741	18-3715
240	1978	18-3708-1	18-4231	18-4223	18-3741	18-3715	3.8	1981-85	18-3708-1	18-4231	18-4223	18-3741	18-3715
260	1979-81	18-3708-1	18-4231	18-4223	18-3741	18-3715	4.3	1985-92	18-3708-1	18-4231	18-4223	18-3741	18-3715
262	1987-89	18-3708-1	18-4231	18-4223	18-3741	18-3715	5	1982-92	18-3708-1	18-4231	18-4223	18-3741	18-3715
350	1988-91	18-3708-1	18-4231	18-4223	18-3741	18-3715	5.7	1979-92	18-3708-1	18-4231	18-4223	18-3741	18-3715
351	1992	18-3708-1	18-4231	18-4223	18-3741	18-3715	5.8	1989-92	18-3708-1	18-4231	18-4223	18-3741	18-3715
454	1990-92	18-3708-1	18-4231	18-4223	18-3741	18-3715	7.5	1987	18-3708-1	18-4231	18-4223	18-3741	18-3715

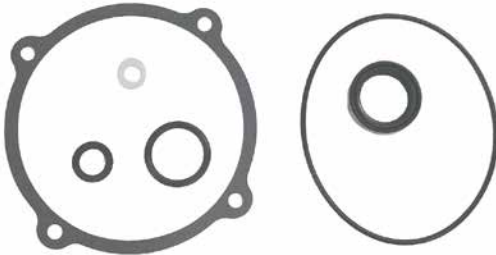

18-2698
KIT RETENES ALOJAMIENTO EMBRAGUE
Para: todos modelos 1977 e inferiores

— CONTIENE —

Ref #	Desc.	O.E. #	Cant.
18-7114	ARO TÓRICO	302540	1
18-7400	ARO TÓRICO	908194	1
18-7952	RETÉN ACEITE	911019	1
18-2863	JUNTA TAPA	308799	1
18-4248	ARANDELA	311598	1
18-0939	JUNTA CAJA ENGRANAJES SUPERIOR	315189	1

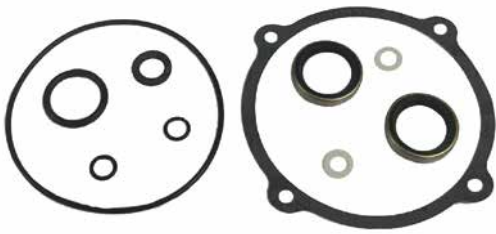

18-8360
KIT RETENES ALOJAMIENTO EMBRAGUE
Para: Todos modelos 1978 & superiores

— CONTIENE —

Ref #	Desc.	O.E. #	Cant.
18-2060	RETÉN ACEITE	321467	2
18-7114	ARO TÓRICO	302540	1
18-7168	ARO TÓRICO	202893	2
18-7400	ARO TÓRICO	908194	1
18-2863	JUNTA TAPA	308799	1
18-4248	ARANDELA	311598	2
18-0939	JUNTA CAJA ENGRANAJES SUPERIOR	315189	1

HP	Año	Kit Retenes	HP	Año	Kit Retenes	HP	Año	Kit Retenes	HP	Año	Kit Retenes
80	1968-1969	18-2698	140	1980-1981	18-8360③	190	1974-1977	18-2698	230	1980-1981	18-8360②
90	All	18-2698	3.0L	1982-1985	18-8360	200	1966-1968	18-2698	235	Todos	18-2698
100	1972-1973	18-2698	155	1967-1972	18-2698	200	1979-1980	18-2698①	240	1978	18-2698
120	1965-1978	18-2698	165	1972-1976	18-2698	200	1980-1981	18-8360②	245	1972-1975	18-2698
120	1979-1980	18-2698①	3.8L	1981-1983	18-8360	5.0L	1982-1985	18-8360	250	1979	18-2698
120	1980-1985	18-8360③	170	1974	18-2698	210	1968-1970	18-2698	260	1979-1980	18-2698①
2.5L	1982-1985	18-8360	175	1975-1977	18-2698	215	1971	18-2698	260	1980-1981	18-8360②
140	1973-1978	18-2698	185	1967-1968	18-2698	225	Todos	18-2698	5.7L	1982-1985	18-8360
140	1979-1980	18-2698①	185	1978	18-2698	230	1979-1980	18-2698①			

① 1980 Modelos con sufijo "C" ② 1980 Modelos con sufijo "K" o "U" ③ 1980 Modelos con sufijo "C1"

El Zinc es solo para aplicaciones de agua salada.
El Magnesio es sólo para aplicaciones de agua dulce.
El aluminio es para agua dulce como para salada.

 <p>⑤ 009366 ÁNODO Reemplaza: 982277, 982438 Para alojamiento intermedio modelo Stringer</p>	 <p>⑤ 009368 ÁNODO Reemplaza: 976669</p>	 <p>⑤ 025339 ④ 18-6024A ÁNODO Reemplaza: 393023, 436745 (1982-87) Para usar con caja engranajes</p>	 <p>⑤ 18-6025 ÁNODO Reemplaza: 433458, 398331</p>
--	--	---	---

④ Aluminio ⑤ Zinc

 <p>③ 009318 ÁNODO Reemplaza: 392123 Para alojamiento escape, V4 & V6 (1983-90)</p>	 <p>③ 025840 ① 18-6028A ② 18-6102 ÁNODO Reemplaza: 984513, 3853818, 3855412 Para usar con caja engranaje: 2.3L (1987-90), 2.6L/3.5L/4.6L (1989), 3.0L/4.3L/5.0L/5.8L (1987-93), 5.7L (1987-92), 7.4L (1987-88)</p>	 <p>③ 18-6029 ÁNODO Reemplaza: 397768</p>
 <p>③ 18-6095 ① 18-6095A ÁNODO Reemplaza: 431708 Para usar con caja engranaje (1988-90)</p>	 <p>③ 18-6101 ÁNODO Reemplaza: 983494 Para: Cobra unidades inferiores (1987) 2.5, 3.0, 4.3, 5.0, 5.7</p>	 <p>③ 18-6103 ① 18-6103A ÁNODO Reemplaza: 984547 Para usar con montaje Transom: 2.3L/3.0L (1987-89), 2.6L (1989)</p>
 <p>③ 18-6155Z KIT ÁNODO Para: Cobra transmisión excepto King Cobra</p>	<p>PKG. OF 5</p>  <p>18-3722 18-3722-9④ TUERCAS APRIETE ACERO INOXIDABLE Reemplaza: 121731 (1/4" — 28)</p>	 <p>18-2454 TORNILLO DRENAJE Reemplaza: 3854539 3/8" - 16 rosca Usar aro tórico 18-7145 Para: Cobra SX drives</p>
 <p>18-2138 COJINETE PIVOTE Reemplaza: 911787 COBRA (2 para COLA)</p>	 <p>18-7634 TRANSMISOR TRIM Reemplaza: 984748 Para: OMC Cobra</p>	



18-2663
KIT RETENES ENGRANAJE INFERIOR
 Reemplaza: 981797
 100-245 Stringer Unit (1968-77)

— CONTIENE —

Ref #	Desc.	O.E. #	Cant.
18-0168	Casquillo	908594	1
18-2012	Retén aceite	310599	4
18-2020	Retén aceite	310649	1
18-2058	Retén aceite	313353	2
18-2851	Junta aloj. inferior a cojinete transmisión	313368	1
18-4248	Arandela	311598	2
18-7120	Aro tórico	307853, 322598	4
18-7129	Aro tórico	314491	1
18-7135	Aro tórico	310584	1
18-7167	Aro tórico	310414	1

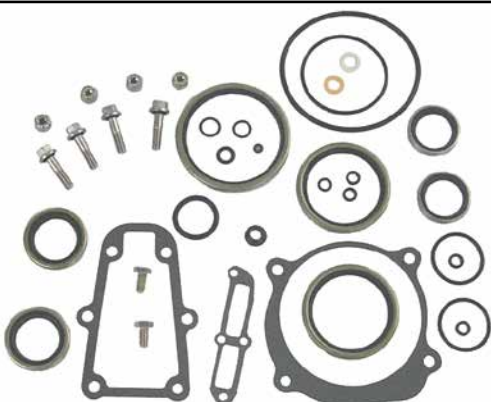

18-2664
KIT RETENES ENGRANAJE INFERIOR
 Reemplaza: 982947
 4 cil (400) Stringer Unit (1978-86)

— CONTIENE —

Ref #	Desc.	O.E. #	Cant.
18-0110	Junta alojamiento	324670	1
18-3133	Tornillo alojamiento	908158	2
18-0188	Arandela	909748	1
18-2020	Retén aceite	310649	1
18-2058	Retén aceite	313353	2
18-2060	Retén aceite	321467	2
18-3722	Tuerca apriete	121731	4
18-4248	Arandela	311598	2
18-7101	Aro tórico	305739	1
18-7102	Aro tórico	307450	1
18-7120	Aro tórico	307853, 322598	1
18-7127	Aro tórico	313446	1
18-7130	Aro tórico	314728	1
18-7178	Aro tórico	320140	1
18-7404	Aro tórico	909747	1
18-7475	Aro Quad	332583	4
18-7168	Aro tórico	202893	1
18-7409	Aro tórico	911871	2
18-2001	Retén aceite	330137	2
18-7479	Aro tórico	—	1
18-3153	Tornillo	908158	2

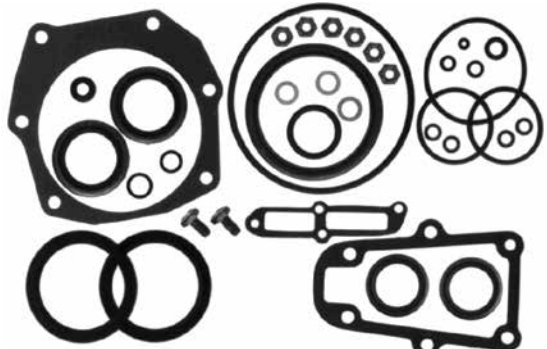

18-2665
KIT RETENES ENGRANAJE SUPERIOR
 Reemplaza: 982946
 V6,V8 (800) Stringer Unit (1978-86)

— CONTIENE —

Ref #	Desc.	O.E. #	Cant.
18-0110	Junta alojamiento	324670	1
18-3133	Tornillo alojamiento	908158	2
18-0188	Arandela	909748	1
18-2002	Retén aceite	320862	2
18-2020	Retén aceite	310649	1
18-2058	Retén aceite	313353	2
18-2060	Retén aceite	321467	2
18-2911	Junta alojamiento transmisión	910236	1
18-3722	Tuerca apriete	121731	6
18-4248	Arandela	311598	2
18-7101	Aro tórico	305739	1
18-7102	Aro tórico	307450	1
18-7120	Aro tórico	307853, 322598	1
18-7130	Aro tórico	314728	1
18-7142	Aro tórico	322119	1
18-7178	Aro tórico	320140	1
18-7403	Aro tórico	909316	2
18-7404	Aro tórico	909747	1
18-7475	Aro Quad	332583	4
18-7168	Aro tórico	202893	1
18-7479	Aro tórico	—	1
18-3153	Tornillo	908158	2



18-2666
KIT RETENES ALOJAMIENTO ENGRANAJE SUP
 Reemplaza: 981799
 100-245 Stringer Unit (1968-72)

— CONTIENE —

Ref #	Desc.	O.E. #	Cant.
18-0939	Junta engranaje sup	315189	1
18-2073	Retén aceite	981268	4
18-3111	Retén goma	907774	1
18-4248	Arandela	311598	2
18-7103	Aro tórico	308624	4
18-7107	Aro tórico	313175	1
18-7121	Aro tórico	308621	1
18-7134	Aro tórico	303059	1
18-7146	Aro tórico	554545	1
18-7173	Aro tórico	910582	1
18-7198	Aro tórico	308626	2
18-7158	Aro tórico	310585, 310967	1
18-7172	Aro tórico	553126	1

CONTIENE –

Ref #	Desc.	O.E. #	Cant.
18-0939	Junta engranaje superior	315189	1
18-2072	Retén aceite	0765461	2
18-2073	Retén aceite	981268	2
18-3111	Retén goma	907774	1
18-3725	tuerca apriete	908064	1
18-4248	Arandela	311598	2
18-4251	Tapón	908062	1
18-7107	Aro tórico	313175	1
18-7114	Aro tórico	302540	1
18-7121	Aro tórico	308621	1
18-7129	Aro tórico	314491	1
18-7477	Aro quad	909048	1
18-7168	Aro tórico	202893	1
18-7172	Aro tórico	553126	1
18-7173	Aro tórico	910582, 310327	1

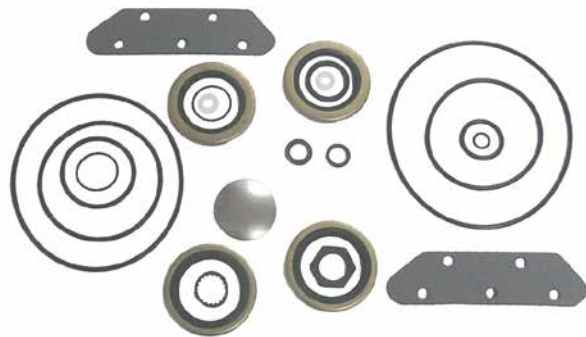

18-2667
KIT RETÉN UNIDAD SUPERIOR
 Reemplaza: 982949
 Todas Stringer Unit (1973-86)

CONTIENE –

Ref #	Desc.	O.E. #	Cant.
18-0917	Junta motor tilt	311508	1
18-0923	Junta retén	313244	2
18-0939	Junta caja engranajes superior	315189	1
18-0949	Junta tapa	316499	2
18-2004	Retén aceite	–	1
18-2016	Retén aceite	0764337	2
18-2066	Retén aceite	911019	1
18-2071	Retén aceite	981195	2
18-3725	Tuerca apriete	908064	1
18-4248	Arandela	311598	1
18-4251	Conector	908062	1
18-7114	Aro tórico	302540	1
18-7162	Aro tórico	302337	1
18-7400	Aro tórico	908194	1
18-7401	Aro tórico	908383	1
18-7198	Aro tórico	308626	2
18-2863	Junta tapa tilt	308799	1

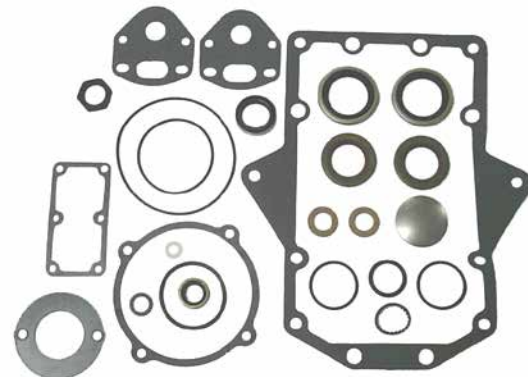

18-2669
KIT RETENES ALOJAMIENTO INTERMEDIO
 Reemplaza: 981801
 100-245 Stringer Unit (1973-77)

CONTIENE –

Ref #	Desc.	O.E. #	Cant.
18-2004	Retén aceite	–	1
18-2016	Retén aceite	0764337	2
18-2060	Retén aceite	321467	2
18-2071	Retén aceite	981195	2
18-2863	Junta tapa tilt	308799	1
18-3725	Tuerca apriete	908064	1
18-4248	Arandela	311598	3
18-4251	Tapón	908062	1
18-7114	Aro tórico	302540	1
18-7162	Aro tórico	302337	1
18-7400	Aro tórico	908194	1
18-7401	Aro tórico	908383	1
18-7168	Aro tórico	202893	3
18-7198	Aro tórico	308626	2
18-0917	Junta motor Tilt	311508	1
18-0923	Retén	313244	2
18-0939	Junta superior engranajes	315189	1
18-0947	Junta tapa pivote	909529	2
18-0913	Junta motor tilt	909902	1

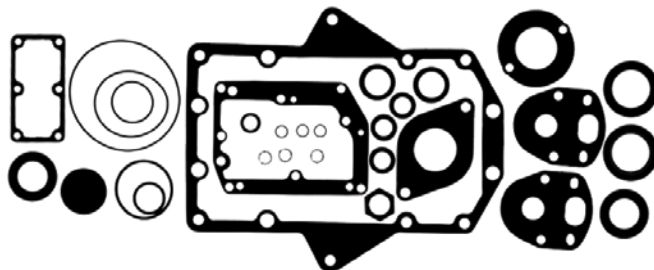

18-2670
KIT RETENES ALOJAMIENTO INTERMEDIO
 Reemplaza: 982948
 Todos Stringer Unit (1978-86)

CONTIENE –

Ref #	Desc.	O.E. #	Cant.
18-0880	Junta tapa	911878	1
18-0166	Casquillo	911705	2
18-0190	Retén	912157	1
18-4248	Arandela	311598	2
18-7127	Aro tórico	313446	1
18-7130	Aro tórico	314728	1
18-7137	Aro tórico	318372	1
18-7138	Aro tórico	318717	3
18-7145	Aro tórico	333572	2
18-7475	Aro Quad	332584	5
18-2001	Retén aceite	330137	2

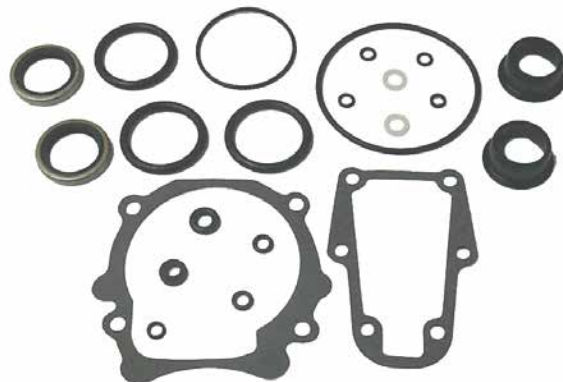

18-2671
KIT RETENES UNIDADES INFERIORES
 Reemplaza: 985612
 Todos 4 cil. Cobra (1986-89)

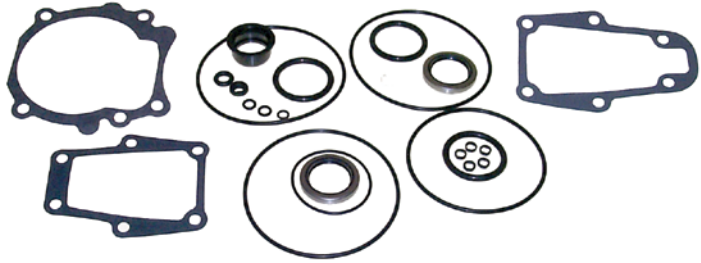

18-2672
KIT RETEN UNIDADES INFERIOR
 Reemplaza: 984458, 985613, 439967
 Todas V6/V8 Cobra (1986-1991)

— CONTIENE —

Ref #	Desc.	O.E. #	Cant.
18-0880	Junta tapa	911878	1
18-0166	Casquillo	911705	2
18-0190	Retén	912157	1
18-2002	Retén aceite	320862	2
18-4248	Arandela	311598	2
18-7130	Aro tórico	314728	1
18-7137	Aro tórico	318372	1
18-7138	Aro tórico	318717	3
18-7142	Aro tórico	322119	1
18-7145	Aro tórico	333572	2
18-7475	Aro Quad	332584	5
18-0440	Junta paso agua	915719	1

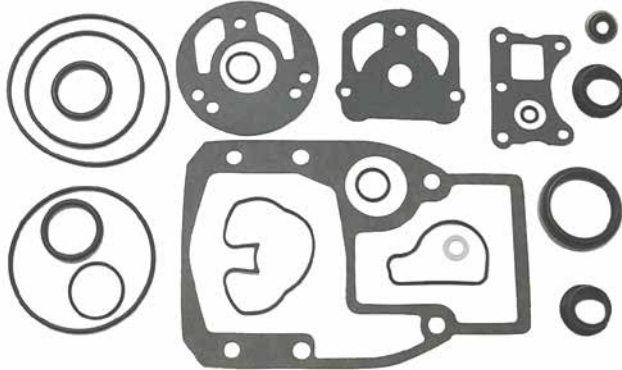

18-2673
KIT RETENES UNIDADES SUPERIOR
 Reemplaza: 984459, 986364, 987603
 Todos Cobra (1986-89)

— CONTIENE —

Ref #	Desc.	O.E. #	Cant.
18-0911	Junta base bomba agua	911698	1
18-0884	Junta tapa	911733	1
18-0166	Casquillo	911705	2
18-2067	Retén aceite	911685	1
18-2068	Retén aceite	3853655	1
18-2541	Retén goma	911704	1
18-2916	Junta alojamiento bomba agua	911702	1
18-2918	Transom	915840	1
18-2996	Retén	911823	1
18-7107	Aro tórico	313175	1
18-7116	Aro tórico	303067	1
18-7138	Aro tórico	318717	2
18-7153	Aro tórico	—	2
18-7169	Aro tórico	911686	1
18-7403	Aro tórico	909316	1
18-7407	Aro tórico	911700	1



18-2674
KIT RETENES ALOJAMIENTO TRANSMOM
 Reemplaza: 985518, 986423
 Todos Cobra (1986-89)

— CONTIENE —

Ref #	Desc.	O.E. #	Cant.
18-2070	Retén aceite	911795	1
18-2138	Cojinete	911787	3
18-2139	Cojinete	911794	1
18-2533	Retén espuma	911797	1
18-2918	Transom	915840, 911836	1
18-2996	Retén	911823	1
18-4250	Arandela	911820	2
18-7141	Aro tórico	321117	12
18-7143	Aro tórico	322501	1
18-7162	Aro tórico	302337	1
18-7165	Aro tórico	304174	1
18-7406	Aro tórico	911311	3
18-7408	Aro tórico	911718	2
18-7409	Aro tórico	911871	1
18-7168	Aro tórico	202893	1
18-8349	Retén	3852548	1



18-2783
KIT RETÉN UNIDAD INFERIOR
 Reemplaza: 986629
 King Cobra unidad inferior - 1990



18-2791
KIT RETENES COLA
 Reemplaza: 987251, 3850597
 Para: 3.0L, 4.3L, 5.0L (1994), 3.2L (1992-93),
 5.7L (1992-94), 7.4L (1992-95), 8.2L (1992-93)

APLICACIÓN KIT RETENES

Modelo	Año	Kit engranaje inferior	Kit engranaje superior	Kit alojamiento intermedio	Kit Montaje transom	Modelo	Año	Kit engranaje inferior	Kit engranaje superior	Kit alojamiento intermedio	Kit Montaje transom
2.3	1987-90	18-2671	18-2673	N/D	18-2674	165	1972	18-2663	18-2666	18-2668	N/D
2.5 ①	1982-86	18-2664	18-2667	18-2670	N/D	165	1973-76	18-2663	18-2667	18-2669	N/D
2.5 ②	1986	18-2671	18-2673	N/D	18-2674	170	1974	18-2663	18-2667	18-2669	N/D
3 ①	1982-86	18-2664	18-2667	18-2670	N/D	175	1975-77	18-2663	18-2667	18-2669	N/D
3 ②	1986-91	18-2671	18-2667	18-2670	N/D	185	1968	18-2663	18-2666	18-2668	N/D
4.3 ①	1985-86	18-2665	18-2667	18-2670	N/D	185	1978-80	18-2665	18-2667	18-2670	N/D
4.3 ②	1986-91	18-2672	18-2673	N/D	18-2674	190	1974-77	18-2663	18-2667	18-2669	N/D
3.8	1981-86	18-2665	18-2667	18-2670	N/D	200	1968	18-2663	18-2666	18-2668	N/D
5 ①	1982-86	18-2665	18-2667	18-2670	N/D	200	1979-81	18-2665	18-2667	18-2670	N/D
5 ②	1986-91	18-2672	18-2673	N/D	18-2674	210	1968-70	18-2663	18-2666	18-2668	N/D
5.7 ①	1982-86	18-2665	18-2667	18-2670	N/D	215	1971	18-2663	18-2666	18-2668	N/D
5.7 ②	1986-89	18-2672	18-2673	N/D	18-2674	225	1972	18-2663	18-2666	18-2668	N/D
5.7 ③	1990-91	18-2672	18-2673	N/D	18-2674	225	1973-76	18-2663	18-2667	18-2669	N/D
5.8	1989-90	18-2672	18-2673	N/D	18-2674	225	1978	18-2665	18-2667	18-2670	N/D
7.5	1987	—	18-2673	N/D	18-2674	230	1979-81	18-2665	18-2667	18-2670	N/D
80	1969	18-2663	18-2666	18-2668	N/D	235	1971	18-2663	18-2666	18-2668	N/D
90	1970	18-2663	18-2666	18-2668	N/D	235	1975-77	18-2663	18-2667	18-2669	N/D
100	1972	18-2663	18-2666	18-2668	N/D	240	1978	18-2665	18-2667	18-2670	N/D
100	1973	18-2663	18-2667	18-2669	N/D	245	1972	18-2663	18-2666	18-2668	N/D
120	1968-72	18-2663	18-2666	18-2668	N/D	245	1973-75	18-2663	18-2667	18-2669	N/D
120	1973-77	18-2663	18-2667	18-2669	N/D	250	1979	18-2665	18-2667	18-2670	N/D
120	1978-81	18-2664	18-2667	18-2670	N/D	260	1979-81	18-2665	18-2667	18-2670	N/D
140	1973-77	18-2663	18-2667	18-2669	N/D	262	1989	18-2672	18-2673	N/D	18-2674
140	1978-81	18-2664	18-2667	18-2670	N/D	350	1988-89	18-2672	18-2673	N/D	18-2674
155	1968-72	18-2663	18-2666	18-2668	N/D	460	1988-89	—	18-2673	N/D	18-2674

① Excepto Cobra ② Cobra ③ Excepto L.E. N/D No disponible

RETENES ACEITE



Ref #	O.E. #	Diámetro eje	Dimensiones (pulg)		Ref #	O.E. #	Diámetro eje	Dimensiones (pulg)	
			D.E.	ancho				D.E.	ancho
18-0542	321831, 315288	0.750	1.253	0.186	18-2061	329922	0.822	1.375	0.195
18-0543	321895, 313507	1.540	1.926	0.243	18-2062	329923	0.875	1.375	0.207
					18-2063	330327	0.625	1.124	0.188
18-0559	332585	0.285	0.357	0.940	18-2064	332205	0.730	1.130	0.194
18-2000	309989	1.375	2.000	0.313	18-2065	332261	0.625	1.375	0.195
18-2001	330137	1.125	1.624	0.250	18-2066	911019	1.000	1.375	0.435
18-2002	320862	1.188	1.692	0.250	18-2067	911685	2.000	2.509	0.315
18-2005	313284	0.625	1.128	0.250	18-2068	3853655	0.500	0.905	0.250
18-2012	310599	1.000	1.499	0.250	18-2068	915702	0.500	0.905	0.250
18-2016	0764337	1.187	1.875	0.250	18-2068	916058	0.500	0.905	0.250
18-2018	0767970	1.000	1.375	0.250	18-2068	3853655	0.500	0.905	0.200
18-2020	310649	2.500	3.000	0.250	18-2071	981195	1.500	2.125	0.250
18-2022	303345	0.554	1.000	0.375	18-2072	0765461	1.750	2.502	0.250
18-2023	313282	0.554	1.062	0.312	18-2073	981268	1.625	2.502	0.250
18-2024	314167	0.425	0.937	0.312	18-8349	3852548	1.375	2.186	0.500
18-2025	318972	0.500	0.875	0.250					
18-2027	321459	0.625	1.125	0.250					
18-2030	321786	0.625	1.125	0.188					
18-2031	321787	0.625	1.125	0.312					
18-2033	321928	0.625	1.375	0.250					
18-2034	324639	0.437	0.937	0.188					
18-2058	313353	1.938	2.438	0.250					
18-2059	321466	0.750	1.126	0.200					
18-2060	321467	1.000	1.375	0.250					



CARCASA SUPERIOR (Cobra)				
MOTOR	Año	RETÉN ACEITE	DESC.	CANT
262 - 460	1988-89	18-2067	BC	1
262 - 460	1988-90	18-2068	WPS	1
2.3 - 7.5	1986-90	18-2068	WPS	1
2.3 - 7.5 ①	1986-90	18-2067	BC	1
① 5.7 '90 574 AMPWS, ARPWS BC Retén cojinete WPS Retén bomba agua				
CARCASA INFERIOR (Stringer)				
MOTOR	AÑO	RETÉN ACEITE	DESC.	CANT
80/90	1968-71	18-2066	BR,L	2
80/90	1968-71	18-2066	PS	2
88/90	1964-68	18-2012	BR	1
80 - 260	1968-81	18-2020	BR,U	1
80 - 260	1968-81	18-2058	BR,M	2
110 - 200 ①	1964-67	18-2012	BR	2
110 - 245 ①	1964-77	18-2012	PS	2
110/120 ②	1964-67	18-2012	BR	1
120 - 245	1968-77	18-2012	BR,L	2
120 - 260	1978-81	18-2060	BR,L	2
120/140	1978-81	18-2001	PS	2
155 ③	1967	18-2058	BR,M	2
155 ③	1967	18-2020	BR,U	1
185 - 260	1978-81	18-2002	PS	2
210 - 260 ④	1972-75	18-2066	IH	1
230/260 ④	1976	18-2060	IH	1
305/350/454 ④	1977-78	18-2060	IH	1
2.5/3.0	1982-86	18-2001	PS	2
2.5 - 5.7	1981-86	18-2020	BR,U	1
2.5 - 5.7	1981-86	18-2058	BR,M	2
2.5 - 5.7	1981-86	18-2060	BR,L	2
3.8 - 5.7	1981-86	18-2002	PS	2
① 110, 120 HP '64-67 Hvy. Duty Dr. ② Ø'kpj fp' kIPq'ka^ca ③ Modelos HU, HUE 16 C ④ Intraborda BR Retén cojinete eje transmisión BR,U Retén cojinete superior eje transmisión BR,M Retén cojinete medio eje transmisión BR,L Retén cojinete inferior eje transmisión IH Retén alojamiento impulsor PS Retén eje hélice				

CARCASA SUPERIOR (Stringer)				
MOTOR	AÑO	RETÉN ACEITE	DESC.	CANT
80 - 245	1968-72	18-2073	BGS	1
80 - 260	1969-81	18-2073	IH	2
88 - 200	1964-66	18-2000	BGS	1
90 ③	1967	18-2000	BGS	1
90 ④	1967	18-2073	BGS	1
100 - 245	1972-73	18-2073	BGS	1
100 - 260	1973-81	18-2072	BGS	2
120 ①	1967	18-2073	BGS	1
120 ②	1967	18-2000	BGS	1
120 ①	1967	18-2073	IH	2
120 - 210	1968	18-2073	IH	2
155	1967	18-2073	IH	2
155 ⑤	1967	18-2000	BGS	1
155	1967	18-2073	BGS	1
185	1967	18-2000	BGS	1
200 ⑥	1967	18-2000	BGS	1
200 ⑦	1967	18-2073	IH	2
200 ⑦	1967	18-2073	BGS	1
2.5 - 5.7	1981-86	18-2072	BGS	2
2.5 - 5.7	1981-86	18-2073	IH	2
① Modelos CU, CUE 16C ⑥ Modelos TU, TUE 15S ② Modelos CU15S Models ⑦ Modelos TU, TUE 16C ③ Modelos DU, DUE 14D BGS Retén eje ④ Modelos DU, DUE 15S IH Retén alojamiento impulsor ⑤ Modelos HU, HUE 15S				
CARCASA INFERIOR (Cobra)				
MOTORES	AÑO	RETÉN ACEITE	DESC.	CANT
262 - 460	1988-89	18-2002	PS	2
2.3	1990	18-2001	PS	2
2.3 - 3.0	1986-89	18-2001	PS	2
3	1990	18-2002	PS	2
4.3 - 7.5	1986-90	18-2002	PS	2
PS Retén eje hélice				
ALOJAMIENTO INTERMEDIO (Stringer)				
MOTOR	AÑO	RETÉN ACEITE	DESC.	CANT
80 - 235	1964-71	18-2000	BG,O	1
80 - 245	1964-72	18-2001	BG,I	1
80 - 260 ②	1964-80	18-2066	CL	1
100 - 245	1972	18-2000	BG,O	2
100 - 260	1973-79	18-2016	BG,I	1
100 - 260	1973-81	18-2071	BG,O	2
120 - 260	1980-81	18-2016	BG,I	2
120 - 260 ①	1980-81	18-2060	CL	2
2.5 - 5.7	1981-86	18-2060	CL	2
2.5 - 5.7	1981-86	18-2016	BG,I	2
2.5 - 5.7	1981-86	18-2071	BG,O	2
CL Embrague ① 120, 140 '80C Modelos/185-260 '80 K&U Modelos ② C Modelos en '80 BG,I Retén inferior eje transmisión BG,O Retén exterior eje transmisión				



AROS TÓRICOS

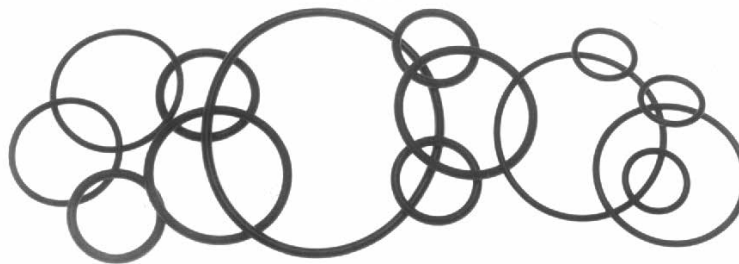

I/O – OMC STERNDRIVE/COBRA - Aros tóricos

Ref #	O.E. #	Dimensiones (pulg.)		Ref #	O.E. #	Dimensiones (pulg.)	
		D.I.	Ancho			D.I.	Ancho
18-7100	② ⑤	301877	.245 .155	18-7150	③ ⑤	331380	.225 .115
18-7101	② ⑤	305739	.250 .065	18-7150	③ ⑤	334913	.225 .115
18-7102	② ⑤	307450	.430 .065	18-7152	② ⑤	307082	2.625 .135
18-7103	② ⑤	308624	.920 .100	18-7153	①	3852565,	
18-7104	② ⑤	308627	2.210 .135			911851	.0860 .100
18-7105	② ⑤	311338	.750 .065	18-7155	② ⑤	305270	1.620 .135
18-7107	② ⑤	313175	4.750 .135	18-7156	② ⑤	309731	1.185 .100
18-7108	② ⑤	313893	2.550 .100	18-7158	② ⑤	310585	.740 .100
18-7108	② ⑤	338518	2.550 .100	18-7162	② ⑤	302337	2.025 .135
18-7109	② ⑤	317178	.214 .048	18-7164	② ⑤	302537	1.375 .100
18-7111	①	301824	.197 .113	18-7165	② ⑤	304174	.500 .065
18-7112	①	302493	1.170 .135	18-7167	② ⑤	310414	3.625 .135
18-7114	② ⑤	302540	1.000 .135	18-7168	② ⑤	202893	.370 .065
18-7115	①	302588	1.735 .135	18-7169	② ⑤	911686	3.500 .135
18-7116	①	303067	.360 .100	18-7170	①	307239	1.365 .135
18-7117	①	303360	1.060 .135	18-7172	② ⑤	553126	3.250 .135
18-7118	② ⑤	305242	.300 .135	18-7173	② ⑤	310327	1.875 .135
18-7120	①	307853	.215 .065	18-7174	② ⑤	326649	.620 .100
18-7120	①	332598	.215 .065	18-7178	② ⑤	320140	.920 .135
18-7121	①	308621	3.100 .135	18-7180	② ⑤	303347	.445 .090
18-7123	①	308876	2.235 .100	18-7198	② ⑤	308626	1.430 .100
18-7126	①	313340	1.690 .100	18-7400	② ⑤	908194	4.000 .100
18-7127	①	313446	3.315 .135	18-7401	② ⑤	908383	2.485 .100
18-7128	①	313754	1.835 .100	18-7403	② ⑤	909316	1.500 .100
18-7129	② ⑤	314491	.970 .065	18-7404	② ⑤	909747	.300 .100
18-7130	①	314728	2.125 .100	18-7406	② ⑤	911311	0.250 .065
18-7133	② ⑤	305123	3.780 .135	18-7407	② ⑤	911700	4.125 .135
18-7134	② ⑤	303059	.500 .100	18-7407	② ⑤	3852531	4.125 .135
18-7135	①	310584	.750 .135	18-7408	② ⑤	911718	1.060 .100
18-7137	② ⑤	318372	0.320 .155	18-7409	② ⑤	911871	1.175 .100
18-7138	② ⑤	318717	1.500 .210	18-7413	② ⑤	303191	.301 .070
18-7139	② ⑤	319085	1.080 .210	18-7416	② ⑤	329380	.612 .103
18-7140	② ⑤	320303	2.750 .135	18-7417	② ⑤	329381	.362 .103
18-7141	② ⑤	321117	.180 .065	18-7418	② ⑤	326741	4.484 .139
18-7142	② ⑤	322119	3.940 .135	18-7440-1	④	301967	.799 .103
18-7143	② ⑤	322501, 331188	1.310 .100	18-7457	①	319662	1.799 .103
18-7144	② ⑤	326849	4.250 .135	18-7461	①	308458	1.612 .103
18-7145	② ⑤	333572	.250 .100	18-7475	② ⑤	332584	.250 .065
18-7146	② ⑤	554545	1.120 .100	18-7477	② ⑤	909048	.480 .100
18-7150	③ ⑤	303598	.225 .115	18-7510	①	321163	2.750 .070

① Pack. de 1 ② Pack. de 5 ③ Pack. de 10 ④ Indica Aros Quad en lugar de Aros tóricos

MONTAJE TRANSOM (Cobra)					MONTAJE TRANSOM (Cobra) (Cont.)				
MOTOR	AÑO	ARO TÓRICO	DESC.	CANT.	MOTOR	AÑO	ARO TÓRICO	DESC.	CANT.
262 - 460	1988-89	18-7165	SCS	1	2.3 - 7.5 ①	1986-90	18-7165	SCS	1
262 - 460	1988-89	18-7408	NP	2	2.3 - 7.5 ①	1986-90	18-7409	SC	1
262 - 460	1988-89	18-7409	SC	1	2.3 - 7.5	1986-90	18-7143	MB	1
262 - 460	1988-89	18-7406	PL	1	① 5.7 '90 574 AMPWS, ARPWS BC Retén campana MB retén colector UG Retén superior SCS Retén cable cambio PL Retén tapón NP Retén SC Retén conector				
262 - 460	1988-89	18-7168	BC	1					
262 - 460	1988-90	18-7162	UG	1					
262 - 460	1988-90	18-7143	MB	1					
2.3 - 7.5 ①	1986-90	18-7168	BC	1					
2.3 - 7.5	1986-90	18-7162	UG	1					
2.3 - 7.5 ①	1986-90	18-7406	PL	1					
2.3 - 7.5 ①	1986-90	18-7408	NP	2					

⑤ Este precio de este producto es por pieza. Para pedir precio en envase por favor añadir -9 a la referencia.

CARCASA SUPERIOR (Cobra)				
MOTOR	AÑO	ARO TÓRICO	DESC.	CANT
262 - 460	1988-89	18-7403	A,S	1
262 - 460	1988-89	18-7107	GHC	1
262 - 460	1988-89	18-7407	A,L	1
262 - 460	1988-90	18-7169	BC	1
350 - 460	1990	18-7116	OPF	1
350 - 460	1990	18-7407	BC	1
350 - 460	1990	18-7406	WDP	1
370	1988	18-7407	AB	1
460	1990	18-7407	BC	1
2.3 - 5.8	1990	18-7116	OPF	1
2.3 - 7.5	① 1986-90	18-7107	GHC	1
2.3 - 7.5	① 1986-90	18-7407	A,L	1
2.3 - 7.5	1986-90	18-7169	BC	1
2.3 - 7.5	① 1986-90	18-7403	A,S	1
5.7	② 1990	18-7406	WDP	1
5.7	② 1990	18-7407	BC	1

- ① 5.7 '90 574 AMPWS, ARPWS
- ② 574 PEPWS
- GHC** Retén tapón aloj. engr
- OPF** Retén tapón aceite
- BC** Retén cojinete
- A,S** Retén pequeño adaptador
- A,L** Retén grande adaptador
- WDP** Retén tapón drenaje agual
- AB** Retén bloqueo

CARCASA INFERIOR (Cobra)

MOTOR	AÑO	ARO TÓRICO	DESC.	CANT
262/350	1988-89	18-7475	PBHS	4
262/350	1988-89	18-7142	PBH	1
262 - 460	1988-89	18-7130	DS B	1
262 - 460	1988-89	18-7475	BSS	1
262 - 460	1988-89	18-7138	DS BH	3
262 - 460	1988-89	18-7137	SR	1
350 - 460	1990	18-7145	PL	1
370	1988	18-7130	SL	2
370/460	1988-89	18-7145	D&F S	2
2.3	1987	18-7145	D&F S	2
2.3	1990	18-7127	PBH	1
2.3 - 3.0	1986-89	18-7127	PBH	1
2.3/3.0	1988-90	18-7145	D&F S	2
2.5 - 5.7	1986	18-7145	D&F S	2
2.3 - 5.8	① 1986-90	18-7475	PBHS	4
2.3 - 7.5	① 1986-90	18-7475	BSS	1
2.3 - 7.5	① 1986-90	18-7138	DS BH	3
2.3 - 7.5	① 1986-90	18-7137	SR	1
2.3 - 7.5	① 1986-90	18-7130	DS B	1
3.0 - 5.8	① 1990	18-7142	PBH	1
4.3 - 5.8	1989-89	18-7142	PBH	1
5.7	② 1990	18-7145	PLUG	1

- ① 5.7 '90 574 AMPWS, ARPWS
- ② 574 PEPWS
- BSS** Retén cojinete
- DS BH** Retén cojinete aloj. eje transmisión
- DS B** Retén cojinete eje transmisión
- D&F S** Retén tornillo drenaje y llenado
- PBH** Retén cojinete hélice
- PBHS** Retén cojinete tornillo hélice
- PL** Retén tapón
- SR** Retén cambio
- SL** Retén sleeve

POWER TILT Y TRIM (Cobra)				
MOTOR	AÑO	ARO TÓRICO	DESC.	CANT
262 - 460	1988-90	18-7141	OL	12
262 - 460	1988-90	18-7102	PL	1
350 - 460	1988	18-7174	VSH	1
350 - 460	1988	18-7168	VS	4
350 - 460	1988	18-7174	VA,L	2
350 - 460	1988	18-7165	VA,S	2
2.3 - 7.5	1986-88	18-7174	VSH	1
2.3 - 7.5	1986-88	18-7168	VS	4
2.3 - 7.5	1986-88	18-7174	VA,L	2
2.3 - 7.5	1986-88	18-7165	VA,S	2
2.3-7.5	1986-90	18-7102	PL	1
2.3-7.5	1986-90	18-7141	OL	12

- PL** Retén tapón
- VS** Retén asiento válvula
- VA,L** Retén grande asiento válvula
- VA,S** Retén pequeño asiento válvula
- VSH** Retén alojamiento asiento válvula
- OL** Retén línea aceite

SISTEMA REFRIGERACIÓN Y ACEITE (Cobra)

MOTOR	AÑO	ARO TÓRICO	DESC.	CANT
262/454	1989-90	18-7135	AR	1
262 - 460	1988-90	18-7116	ODF	1
350/460	1988-90	18-7135	AR	1
370	1988	18-7162	THERM	1
2.3 - 5.8	1988-90	18-7116	ODF	1
4.3	① 1990	18-7135	AR	1
7.5	1987	18-7135	AR	1

- ① V-4 Sólo
- ODF** Retén drenaje aceite
- AR** Retén adaptador
- THERM** Retén termostato

CULATA (Stringer)

MOTOR	AÑO	ARO TÓRICO	DESC.	CANT
80/90	1969-71	18-7108	WP	1
88	1964	18-7133	CCH	3
88/90	1964-68	18-7120	CCHS	4
90	1965-68	18-7133	CCH	4
120/140	1977-80	18-7114	CP	1
120 - 235	1976	18-7114	CP	1

- WP** Retén bomba agua
- CCH** Retén culata
- CCHS** Retén tornillo culata
- CP** Retén acoplado

ALOJAMIENTO INTERMEDIO (Stringer)

MOTOR	AÑO	ARO TÓRICO	DESC.	CANT
80	1968	18-7162	SL	1
80 - 90	1964-68	18-7174	WT	1
80 - 210	1964-70	18-7123	BGR	1
80 - 245	① 1964-72	18-7174	PS	1
80 - 260	1964-81	18-7198	COV	2
80 - 260	1964-81	18-7114	WR	1
80 - 260	1969-81	18-7162	SL	1
88	1964	18-7104	TH	1
88	1964	18-7174	TC	1

ALOJAMIENTO INTERMEDIO (Stringer) (Cont.)				
MOTOR	AÑO	ARO TÓRICO	DESC.	CANT
90 - 235	1970-71	18-7158	DS	1
90 - 235	② 1971	18-7123	BGR	1
100 - 260	1973-81	18-7401	BGR	1
100 - 260	1973-81	18-7400	TUC	1
120	③ 1967	18-7162	SL	1
120 - 210	1968	18-7162	SL	1
120/140	1981	18-7168	FS	3
155	④ 1967	18-7162	SL	1
2.5 - 5.7	1981-86	18-7400	TUC	1
2.5 - 5.7	1981-86	18-7198	COV	2
2.5 - 5.7	1981-86	18-7114	WR	1
2.5 - 5.7	1981-86	18-7401	BGR	1
2.5 - 5.7	1981-86	18-7162	SL	1
2.5 - 5.7	1982	18-7168	FS	3

- ① Modelos dirección de tiro
 ② Todos 90/120, 155, 210 EX Mod-
 elos/235 XUFM20S ant a
 S/N 202880 y 235
 XUFM20S ant a S/N 204600
 ③ CU, CUE 16C
 ④ 120, 155, 215, 20D Modelos/235
 XUFR20S S/N 202880 & sup y 235
 XUFM20S S/N 204600 & sup 235 20D
 todos Modelos
COV Retén tapa pivote
BGR Retén engranaje bolas
DS Retén eje dirección
TC Retén eje tubo dirección
TH Tubo eje dirección a alojamiento
FS Retén tornillo llenado
PS Eje polea
SL Retén alojamiento a sleeve
TUC Retén tapa tilt
WT Retén tubo agua
WR Retén engranaje arrastre

CARCASA SUPERIOR (Stringer)

MOTOR	AÑO	ARO TÓRICO	DESC.	CANT
80 - 90	1968-71	18-7158	BG	1
80 - 90	1964-68	18-7174	IH	1
80 - 245	① 1964-72	18-7103	WG	1
80 - 245	① 1964-74	18-7134	G	1
80 - 260	1964-81	18-7172	IH	1
80 - 260	1964-81	18-7121	BGR	1
80 - 260	1968-80	18-7173	WW	1
80 - 260	② 1968-81	18-7107	WW	1
90	③ 1967	18-7107	WW	1
90 - 200	1964-67	18-7128	CAP	1
90 - 200	1965-67	18-7173	WW	2
90 - 245	④ 1967-72	18-7146	BG	1
100 - 245	1973-75	18-7114	WS	1
100 - 260	1973-81	18-7129	DS IH	1
110 - 120	⑤ 1964-67	18-7158	IH	1
110 - 120	⑥ 1964-67	18-7174	IH	1
120 - 200	⑦ 1967	18-7107	WW	1
120 - 235	1968-71	18-7158	IH	1
120 - 260	1975-81	18-7477	G	1
150 - 210	1964-67	18-7158	IH	1
2.5/3.0	1982	18-7168	OP	1
2.5 - 5.7	1981-86	18-7477	G	1
2.5 - 5.7	1981-86	18-7172	IH	1
2.5 - 5.7	1981-86	18-7107	WW	1
2.5 - 5.7	1981-86	18-7121	BGR	1
2.5 - 5.7	1981-86	18-7129	DS IH	1

CARCASA SUPERIOR (Stringer) (Cont.)

- ① Modelos dirección tiro
 ② 155 HP 1968 HU, HUE 16C
 ③ DU, DUE 15S
 ④ 90 HP '67 DU, DUE 15S/120 and
 200 '67 16C Modelos
 ⑤ Heavy Duty transmisión
 ⑥ Caja engranajes standard
 ⑦ 16C Modelos
BG Retén engranajes
BGR Retén engranaje bolas
DS IH Retén impulsor eje transmisión
IH Retén alojamiento impulsor
CAP Retén tapa aloj. engranaje
OP Retén tapón aceite
WR Retén retenedor dirección
WS Retén espaciador dirección
WG Retén engranaje dirección
WW Retén dirección
G Retén engranaje

CARCASA INFERIOR (Stringer)

MOTOR	AÑO	ARO TÓRICO	DESC.	CANT
80 - 90	1964-69	18-7120	PBH S	4
80 - 90	1964-71	18-7152	PBH	1
80 - 90	1964-71	18-7115	BR	1
80 - 90	1964-71	18-7174	DS	1
88/90	1964-68	18-7173	DSB	2
90 - 245	1970-77	18-7120	PBH S	4
100 - 245	1968-72	18-7135	BR	1
100 - 245	1969-77	18-7167	PBH	1
110/120	② 1964-67	18-7167	PBH	1
110/120	① 1964-67	18-7174	DS	1
110/120	② 1964-67	18-7135	BR	1
110/120	① 1964-67	18-7152	PBH	1
110/120	① 1964-67	18-7173	DSB	2
110/120	① 1964-67	18-7115	BR	1
120	① 1964-67	18-7120	PBH S	4
120/140	1978-81	18-7127	PBH	1
120/140	1978	18-7156	SA,L	2
120 - 235	1977	18-7129	DS	1
120 - 240	1978	18-7178	SA,S	1
120 - 260	1978-81	18-7130	BR	1
120 - 260	1978-81	18-7102	PIN	1
120 - 260	1978-81	18-7109	PBH S	4
120 - 260	1978-81	18-7404	PIN	1
120 - 260	1979-81	18-7120	BSS	1
120 - 260	1981	18-7168	D&F S	1
150 - 200	1964-67	18-7135	BR	1
150 - 210	1964-68	18-7167	PBH	1
185 - 240	1978	18-7403	SA,L	2
185 - 260	1978-81	18-7142	PBH	1
2.5 - 5.7	1981-82	18-7168	D&F S	1
2.5 - 5.7	1981-83	18-7109	PBH S	4
2.5 - 5.7	1981-86	18-7130	BR	1
2.5 - 5.7	1981-86	18-7102	PIN	1
2.5 - 5.7	1981-86	18-7404	PIN	1
2.5 - 5.7	1981-86	18-7120	BSS	1
2.5 - 5.7	1981-86	18-7142	PBH	1
2.5/3.0	1982-86	18-7127	PBH	1
3.8	1981	18-7101	OSV	1

- ① Transmisión estándar
 ② Retén válvula aceite
OSV Retén eje piñón
PIN Retén cojinete eje transmisión
BR Retén transmisión
DS Retén cojinete hélice
PBH Retén eje transmisión
DSB Retén tornillo cojinete hélice
PBH S Retén tornillo llenado y drenaje
D&F S Retén grande cambio
SA,L Retén pequeño
SA,S Kit cojinete retén tornillo
BSS



OMC



AÑO	MOTOR BUJÍA	MODELO	Ref. CHAMPION	AÑO	MOTOR BUJÍA	MODELO	Ref. NGK
1990-87	2.3L Cobra	RS12YC	050949	1990-87	2.3L Cobra	TR5	050708
1996	3.0L SXCobra	RS12YC	050949	1996	3.0L SX Cobra	TR5	050708
1995-90	3.0L Cobra HO	RS12YC	050949	1995-90	3.0L Cobra HO	TR5	050708
1994-93	3.0 Cobra	RS12YC	050949	1994-93	3.0L Cobra	TR5	050708
1992-87	3.0L Cobra	RV15YC4	050928	1992-87	3.0L Cobra	UR4	050878
1996 (.460)	4.3L SXCobra	RV15YC4	050928	1996 (.460)	4.3L SX Cobra	UR4	050878
1996 (.708)	4.3L SXCobra	RS12YC	050949	1996 (.708)	4.3L SX Cobra	TR5	050708
1995-86	4.3L Cobra	RV15YC4	050928	1995-86	4.3L Cobra	UR4	050878
1991-90	4.3L Cobra HO	RV15YC4	050928	1991-90	4.3L Cobra HO	UR4	050878
1994-93	4.3L Cobra HO	RV15YC4	050928	1994-93	4.3L Cobra HO	UR4	050878
1996 (Carb)	5.0 SX Cobra	RV15YC4	050928	1996 (Carb)	5.0L SX Cobra	UR4	050878
1996 (EFI)	5.0L SX Cobra	RS12YC	050949	1996 (EFI)	5.0L SX Cobra	TR5	050708
1995-96 (Carb)	5.0L Cobra	RV15YC4	050928	1995-96 (Carb)	5.0L Cobra	UR4	050878
1995-89 (Carb)	5.0L Cobra HO	RV15YC4	050928	1995-89 (Carb)	5.0L Cobra HO	UR4	050878
1995-94	5.0L Cobra EFI	RS12YC	050949	1995-94	5.0L Cobra EFI	TR5	050708
1993	5.0L Cobra EFI	RV15YC4	050928	1993	5.0L Cobra EFI	UR4	050878
1996	5.7L SX Cobra	RV15YC4	050928	1996	5.7L SX Cobra	UR4	050878
1992-86	5.7L King Cobra	RV15YC4	050928	1992-86	5.7L King Cobra	UR4	050878
1996(Carb)	5.8L SX Cobra	RV15YC4	050928	1996 (Carb)	5.8L SX Cobra	UR4	050878
1996 (EFI)	5.8L SX Cobra	RS9YC	050955	1996 (EFI)	5.8L SX Cobra	TR5	050708
1995-89 (Carb)	5.8L Cobra	RV15YC4	050928	1995-89 (Carb)	5.8L Cobra	UR4	050878
1995-92 (EFI)	5.8L Cobra	RS9YC	050955	1995-92 (EFI)	5.8L Cobra	TR5	050708
1995-93 (EFIHO)	5.8L King Cobra	RS9YC	050955	1995-93 (EFIHO)	5.8L King Cobra	TR5	050708
1996	7.4L SX Cobra	RV15YC4	050928	1996	7.4L SX Cobra	UR4	050878
1995-90 (Carb)	7.4L SX Cobra	RV15YC4	050928	1995-90 (Carb)	7.4L SX Cobra	UR4	050878
1995 (EFI)	7.4L King Cobra	RV15YC4	050928	1995 (EFI)	7.4L King Cobra	UR4	050878
1993-91 (Carb)	7.4L Cobra HO	RV15YC4	050928	1993-91 (Carb)	7.4L Cobra HO	UR4	050878
1990-86	7.5L Cobra	RV15YC4	050928	1990-86	7.5L Cobra	UR4	050878
1996	8.2L SX Cobra	RV15YC4	050928	1996	8.2L SXCobra	UR4	050878
1994-92	8.2L King Cobra	RV15YC4	050928	1994-92	8.2L King Cobra	UR4	050878



PRONAUTIC

Marine Equipment

www.pronautic.net

Solicita tu clave de acceso a **informatica@pronautic.net**
o a nuestro equipo de ventas y accede a través de nuestra
página web a:

-
- Consultas de stocks
-
- Tamita pedidos
-
- Consulta albaranes, Facturas
-
- Todos nuestros catálogos y folletos
-
- Ofertas y promociones
-
- Área Outlet
-

Múltiples aplicaciones a un solo click

APLICACIONES MOTORES DE GASOLINA



Modelo aplic.	Filtro aceite	Filtro comb.	Impulsor	Correa
MB 10 A	18-7878-1	—	18-3080	—
BB 30	18-7878-1	—	18-3080	—
BB 100	18-7878-1	—	18-3080	—
MB 18	18-7878-1	—	18-3080	—
AQ 60 F	18-7878-1	—	18-3080	—
MB 18 F	18-7878-1	—	18-3080	—
AQ 90	18-7878-1	—	18-3080	—
AQ 95	18-7878-1	—	18-3080	—
AQ 100	18-7878-1	—	18-3080	—
AQ 95A	18-7878-1	—	18-3080	—
AQ 110	18-7878-1	—	18-3080	—
AQ 120	18-7878-1	—	18-3080	—
BB 115 A	18-7878-1	—	18-3080	—
BB 115 B	18-7878-1	—	18-3080	—
BB 115 C	18-7878-1	—	18-3080	—
MB 20 A	18-7878-1	—	18-3080	—
MB 20 B	18-7878-1	—	18-3080	—
MB 20 C	18-7878-1	—	18-3080	—
AQ 115 A	18-7878-1	—	18-3080	—
AQ 115 B	18-7878-1	—	18-3080	—
AQ 130 A	18-7878-1	—	18-3080	—
AQ 130 B	18-7878-1	—	18-3080	—
AQ 130 C	18-7878-1	—	18-3080	—
AQ 130 D	18-7878-1	—	18-3080	—
BB 165 A	18-7878-1	—	18-3075	18-4044
BB 170 A	18-7878-1	—	18-3075	18-4044
BB 170 B	18-7878-1	—	18-3075	18-4044
BB 170 C	18-7878-1	—	18-3075	18-4044
AQ 165 A	18-7878-1	—	18-3075	18-4044
AQ 170 A	18-7878-1	—	18-3075	18-4044
AQ 170 B	18-7878-1	—	18-3075	18-4044
AQ 170 C	18-7878-1	—	18-3075	18-4044
AQ 120 B	18-7878-1	18-7862 18-7858	18-3075	18-4044
AQ 125 A	18-7878-1	18-7862 18-7858	18-3075	18-4044
AQ 125 B	18-7878-1	18-7862 18-7858	18-3075	18-15435
AQ 131 A	18-7878-1	18-7862 18-7858	18-3075	18-15435
AQ 131 B	18-7878-1	18-7862 18-7858	18-3075	18-15435
AQ 131 C	18-7878-1	18-7862 18-7858	18-3075	18-15435
AQ 131 D	18-7878-1	18-7862 18-7858	18-3075	18-15435
230A	18-7878-1	18-7862 18-7858	18-3075	18-15435
230B	18-7878-1	18-7862 18-7858	18-3075	18-4044

Modelo aplic.	Filtro aceite	Filtro comb.	Impulsor	Correa
BB 140 A	18-7878-1	18-7862 18-7858	18-3075	18-4044
AQ 140 A	18-7878-1	18-7862 18-7858	18-3075	18-4044
BB 145 A	18-7878-1	18-7862 18-7858	18-3075	18-4044
AQ 145 A	18-7878-1	18-7862 18-7858	18-3075	18-4044
AQ 145 B	18-7878-1	18-7862 18-7858	18-3075	18-15435
AQ 151 A	18-7878-1	18-7862 18-7858	18-3075	18-15435
AQ 151 B	18-7878-1	18-7862 18-7858	18-3075	18-15435
AQ 151 C	18-7878-1	18-7862 18-7858	18-3075	18-15435
250 A	18-7878-1	18-7862 18-7858	18-3075	18-4044
250 B	18-7878-1	18-7862 18-7858	18-3075	18-4044
AQ 171 A	18-7878-1	18-7862 18-7858	18-3075	18-15435
AQ 171 C	18-7878-1	18-7862 18-7858	18-3075	18-15435
251 A	18-7878-1	18-7862 18-7858	18-3075	18-4044
3.0 GL	18-7824-1	—	18-3060	—
3.0 GS	18-7824-1	—	18-3060	—
AQ 175 A	18-7879-1	18-7862 18-7858	18-3081	18-4046
430 A	18-7879-1	18-7862 18-7858	18-3081	18-4046
430 B	18-7879-1	18-7862 18-7858	18-3081	18-4046
AQ 190A	18-7875	—	18-3061	—
AQ 200 B	18-7824-1	18-7862 18-7858	18-3060	18-4046 Ⓢ
AQ 200 C	18-7824-1	18-7862 18-7858	18-3060	18-4046 Ⓢ
AQ 200 D	18-7824-1	18-7862 18-7858	18-3081	18-4046
AQ 200 F	18-7824-1	18-7862 18-7858	18-3081	18-4046
AQ 205 A	18-7879-1	18-7845 18-7858 18-7845	—	18-4046
431 A	18-7879-1	18-7858	—	18-4046
431 B	18-7879-1	18-7845 18-7858	18-3081	18-4046
432 A	18-7879-1	18-7845 18-7858	18-3081	—
434 A	18-7879-1	18-7845 18-7858	18-3081	—
4.3 GL	18-7879-1	—	18-3060	—

Ⓢ Alternador

APLICACIONES MOTORES DE GASOLINA

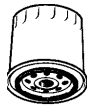

Modelo aplic.	Filtro aceite	Filtro comb.	Impulsor	Correa
4.3 GS	18-7879-1	—	18-3060	—
4.3 GI	18-7879-1	—	18-3081	—
AQ 211 A	18-7824-1	18-7858	18-3081	18-4046
500 A	18-7824-1	18-7845 18-7858	18-3081	18-4046
500 B	18-7824-1	18-7845 18-7858	18-3081	18-4046
AQ 225 B	18-7824-1	18-7862	18-3060	18-4046 Ⓢ
AQ 225 C	18-7824-1	18-7862 18-7858	18-3060	18-4046 Ⓢ
AQ 225 D	18-7824-1	18-7862 18-7858	—	18-4046
AQ 225 E	18-7824-1	18-7862 18-7858	—	18-4046
AQ 225 F	18-7824-1	18-7862 18-7858	—	18-4046
BB 225 A	18-7824-1	18-7862 18-7858	18-3081	—
BB 225 B	18-7824-1	18-7862 18-7858	18-3081	18-4046
BB 225 C	18-7824-1	18-7845 18-7858	18-3081	18-4046
AQ 231 A	18-7824-1	18-7845 18-7858	18-3081	18-4046
AQ 231 B	18-7824-1	18-7845 18-7858	18-3081	18-4046
BB 231 A	18-7824-1	18-7845 18-7858	—	18-4046
501 A	18-7824-1	18-7845 18-7858	18-3081	18-4046
501 B	18-7824-1	18-7845 18-7858	18-3081	18-4046
5.0 FL	18-7875	—	18-3060	18-3081
5.0 FI	18-7875	—	18-3060	18-3081
5.7 GL	18-7824-1	—	18-3060	—
5.7 GI	18-7824-1	—	18-3060	—
5.8 FL	18-7875	—	18-3060	18-3081
5.8 FI	18-7875	—	18-3060	18-3081
5.8 FSI	18-7875	—	18-3060	18-3081
AQ 240 A	18-7875	—	18-3061	—
AQ 255 A	18-7824-1	18-7862 18-7858	—	18-4046
AQ 255 B	18-7824-1	18-7862 18-7858	18-3081	18-4046

Modelo aplic.	Filtro aceite	Filtro comb.	Impulsor	Correa
AQ 260 A	18-7824-1	18-7862 18-7858	18-3081	18-4046
AQ 260 B	18-7824-1	18-7862 18-7858	—	18-4046
BB 260 A	18-7824-1	18-7862 18-7858	18-3081	18-4046
BB 260 B	18-7824-1	18-7862 18-7858	18-3081	18-4046
BB 260 C	18-7824-1	18-7862 18-7858	18-3081	18-4046
BB 261 A	18-7824-1	18-7845 18-7858	18-3081	18-4046
AQ 271 A	18-7824-1	18-7845 18-7858	18-3081	18-4046
AQ 271 B	18-7824-1	18-7845 18-7858	18-3081	18-4046
AQ 271 C	18-7824-1	18-7845 18-7858	18-3081	18-4046
AQ 271 D	18-7824-1	18-7845 18-7858	18-3081	18-4046
570 A	18-7824-1	18-7845 18-7858	18-3081	18-4046
572 A	18-7824-1	18-7845 18-7858	18-3081	18-4046
570 A/MS 4A	18-7824-1	18-7845 18-7858	18-3081	18-4046
AQ 280 A	18-7824-1	18-7862 18-7858	18-3081	18-4046
AQ 290 A	18-7824-1	18-7862 18-7858	18-3081	18-4046
AQ 311 A	18-7824-1	18-7845 18-7858	18-3081	18-4046
AQ 311 B	18-7824-1	18-7845 18-7858	18-3081	—
571 A	18-7824-1	18-7858	18-3081	18-4046
740 A	—	18-7845	—	—
740 B	18-7824-1	18-7845	—	—
7.4 GL	18-7824-1	—	18-3081 18-3060	—
7.4 GI	18-7824-1	—	18-3081	—
7.4 GSI	18-7824-1	—	18-3081	—
8.2 GL	18-7824-1	—	18-3081 18-3060	—

Ⓢ Alternador



APLICACIONES MOTORES DE GASOLINA

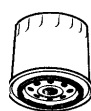

Modelo aplic.	Filtro aceite	Filtro comb.	Impulsor	Correa
2001, B	18-7884	18-7858	18-3076	—
2002, B	18-7884	18-7858	18-3076	—
2003, B	18-7884	18-7858	18-3076	—
2003 T,TB	18-7884	18-7858	18-3081	—
MD 2010 A,B	—	18-7858	18-3079	—
MD 2020 A,B	—	18-7858	18-3079	—
MD 2030 A,B	—	18-7858	18-3080	—
MD 2040 A,B	—	18-7858	18-3080	—
MD 1	—	—	18-3079 ②	—
MD 1 B	18-7884	—	18-3079	—
MD 2	18-7884	—	18-3079 ③	—
MD 2 B	18-7884	—	18-3079	—
AQD 2 B	18-7884	—	18-3079	—
MD 3 B	18-7884	—	18-3080	—
MD 5 A	18-7884	—	18-3076	—
MD 5 B	18-7884	—	18-3076	—
MD 5 C	18-7884	—	18-3076	—
MD 6 A	18-7884	—	18-3079	—
MD 6 B	18-7884	—	18-3076	—
MD 7 A	18-7884	—	18-3076	—
MD 7 B	18-7884	—	18-3076	—
MD 11 C	18-7884	—	18-3076	—
MD 11 D	18-7884	—	18-3076	—
MD 17 C	18-7884	—	18-3080	—
MD 17 D	18-7884	—	18-3080	—
MD 22 A	—	—	18-3081	—
MD 22 L-A	—	—	18-3081	—
TMD 22 A	—	—	18-3081	—
AQD 21 A	—	18-7858	18-3081 ④ 18-3075 ⑤	18-15460
MD 21 A	—	18-7858	18-3081 ④ 18-3075 ⑤	18-15460
AQD 21 B	—	18-7858	18-3081 ④ 18-3075 ⑤	18-15460
MD 21 B	—	18-7858	18-3081 ④ 18-3075 ⑤	18-15460
AQD 32 A	—	18-7858	18-3077	—
MD 32 A	—	18-7858	18-3077	—
MD 30 A	18-7878-1	—	18-3077	—
TMD 30 A	18-7878-1	—	18-3077	—
TAMD 30 A	18-7878-1	—	18-3077	—
AQAD 30 A	18-7878-1	—	18-3077	—
MD 31 A	18-7878-1	—	18-3077	—
TMD 31 A	18-7878-1	—	18-3077	—
AQAD 31 A	18-7878-1	—	18-3077	—
AD 31 A	18-7878-1	—	18-3077	—
TMD 31 B	18-7878-1	—	18-3077	—
TAMD 31 B	18-7878-1	—	18-3077	—
AD 31 B	18-7878-1	—	18-3077	—

Modelo aplic.	Filtro aceite	Filtro comb.	Impulsor	Correa
TMD 31 D	18-7878-1	—	18-3077	—
TAMD 31 D	18-7878-1	—	18-3077	—
AD 31 D	18-7878-1	—	18-3077	—
AD 31 XD	18-7878-1	—	18-3077	—
TMD 31 L-A	18-7878-1	—	18-3077	—
TAMD 31 P,L,M-A	18-7878-1	—	18-3077	—
AD 31 P,L-A	18-7878-1	—	18-3077	—
MD 40 A	—	—	18-3077	—
TMD 40 A	—	—	18-3077	—
AQD 40 A	—	—	18-3077	—
TAMD 40 A	—	—	18-3078	—
AQAD 40 A	—	—	18-3078	—
TMD 40 B	—	—	18-3077	—
TAMD 40 B	—	—	18-3078	—
AQAD 40 B	—	—	18-3078	—
TMD 40 C	—	—	18-3077	—
TMD 41 A	—	—	18-3077	—
AQD 41 A	—	—	18-3077	—
D 41 A	—	—	18-3077	—
TAMD 41 A	—	—	18-3077	—
AQAD 41 A	—	—	18-3077	—
AD 41 A	—	—	18-3077	—
TMD 41 B	—	—	18-3077	—
D 41 B	—	—	18-3077	—
TAMD 41 B	—	—	18-3077	—
AD 41 B	—	—	18-3077	—
KAMD 42 A	—	—	18-3077	—
KAD 42 A	—	—	18-3077	—
TMD 41 D	—	—	18-3077	—
D 41 D	—	—	18-3077	—
TAMD 41 D	—	—	18-3077	—
AD 41 D	—	—	18-3077	—
TMD 41 L-A	—	—	18-3077	—
D 41 L-A	—	—	18-3077	—
TAMD 41 P,L,M,H-A	—	—	18-3077	—
KAMD 42 B	—	—	18-3077	—
KAD 42 B	—	—	18-3077	—
KAMD 42 P-A	—	—	18-3077	—
KAD 42 P-A	—	—	18-3077	—

- ② S/N 14016 & sup
- ③ S/N 4211- & sup
- ④ S/N 103386 & inf
- ⑤ S/N 103387 & sup



**18-5246
KIT ENCENDIDO**
Para: Distribuidores Delco HVS V-6



**18-5247
KIT ENCENDIDO**
Reemplaza: 898253T29
Para : Distribuidores Delco HVS V-8



**18-5256
KIT ENCENDIDO**
— CONTIENE —
Ref # O.E. # Descripción
18-5314 835304 Platinos
18-5338 835308-8 Condensador
18-5411 841243 Rotor



**18-5260
KIT ENCENDIDO**
— CONTIENE —
Ref # O.E. # Descripción
18-5303 835705, 855846-2 Platinos
18-5345 835704 Condensador
18-5403 855845 Rotor
Prestolite



**18-5264
KIT ENCENDIDO**
— CONTIENE —
Ref # O.E. # Descripción
18-5303 835705, 855846-2 Platinos
18-5345 835704 Condensador
18-5425 834975 Rotor
V-8 Prestolite con tapa de clip



**18-5265
KIT ENCENDIDO**
— CONTIENE —
Ref # O.E. # Descripción
18-5305 243799, 1306169, Platinos
243460
18-5348 834560 Condensador
18-5428 243903 Rotor



**18-5266
KIT ENCENDIDO**
Para: Distribuidor Flame Thrower 18-5481, 18-5482, 18-5483, 18-5477, 18-5478, 18-5479



**18-5284
KIT ENCENDIDO**
— CONTIENE —
Ref # O.E. # Descripción
18-5305 243799, 1306169, Platinos
243460
18-5349 841262 Condensador
18-5428 243903 Rotor
Bosch 4 cil.



**18-5303
JUEGO DE PLATINOS**
Reemplaza: 835705, 855846-2



**18-5305
JUEGO DE PLATINOS**
Reemplaza: 241664, 243460, 243799, 1306169



**18-5306
JUEGO PLATINOS**
Reemplaza: 240149



**18-5314
JUEGO PLATINOS**
Reemplaza: 835304



**18-5319
KIT DE PLATINOS**
Reemplaza: 243801



**18-5338
CONDENSADOR**
Reemplaza: 835308



**18-5342
CONDENSADOR**
Reemplaza: 243653



**18-5345
CONDENSADOR**
Reemplaza: 835704



**18-5349
CONDENSADOR**
Reemplaza: 841262
Para: Distribuidores Bosch



**18-5348
CONDENSADOR**
Reemplaza: 834560



**18-5245
ROTOR**
Reemplaza: 3858977
Para: Distribuidores Delco HVS



**18-5402
ROTOR**
Reemplaza: 3862014
Para: Distribuidores Delco EST V-8



**18-5403
ROTOR**
Reemplaza: 855845, 841907, 3853801



**18-5404-1
ROTOR**



**18-5405
ROTOR**
Reemplaza: 33854549, 3862014
V-8 Para nuevos estilos GM "Tapa modulo"

Mirar páginas 904-906 para aplicación
① Referencias acabadas en "D" envasadas - Referencia normal no envasada

 <p>18-5406 ROTOR Reemplaza: 3854261 Para: 3.0L Delco EST "Tapa modulo"</p>	 <p>18-5408 ROTOR Reemplaza: 3854311 Para: 4.3L V6 Delco EST "Tapa modulo"</p>	 <p>18-5411 ROTOR Reemplaza: 841243</p>	 <p>18-5413 ROTOR Reemplaza: 3854218 Para: 5.0L FI, FL, 5.8L FL, FI, FSI</p>	 <p>18-5419 ROTOR Reemplaza: 818525</p>
 <p>18-5425 ROTOR Reemplaza: 834975</p>	 <p>18-5428 ROTOR Reemplaza: 243903</p>	 <p>18-29322 KIT TAPA Y ROTOR Reemplaza: 3854217, 3854215 Para: distribuidores Ford HEI</p>	 <p>18-5248 TAPA DISTRIBUIDOR Reemplaza: 3854217 Para: 5.0FIPMDA, 5.0FIPMDM, 5.8FIPMDA, 5.8FIPMDM, 5.0FIPHUCE, 5.0FIPHUCCE, 5.0FIPHUCE, 5.0FIPHURCE, 5.0FIPHUSCE, 5.0FLPHUB, 5.0FLPHUC, 5.0FLPHUE, 5.0FLPHUR, 5.0FLPHUS, 5.8FIHU, 5.8FIP</p>	 <p>18-5301 KIT ENCENDIDO Reemplaza: Para: Tapa macho distribuidores v-8</p>
 <p>18-5302 KIT ENCENDIDO Reemplaza: Para: Tapa macho distribuidores v-8 flamethrower</p>	 <p>18-5352 TAPA DISTRIBUIDOR Reemplaza: 841070, 3853815</p>	 <p>18-5353 TAPA DISTRIBUIDOR Reemplaza: 841926</p>	 <p>18-5354 TAPA DISTRIBUIDOR Reemplaza: 3854548 Para: V-8 GM Delco EST "Modulo en tapa"</p>	 <p>18-5356 TAPA DISTRIBUIDOR Reemplaza: 243797 Bosch</p>
 <p>18-5357 TAPA DISTRIBUIDOR Reemplaza: 243632, 870690, 1243632</p>	 <p>18-5358 TAPA DISTRIBUIDOR Reemplaza: 841263 Bosch</p>	 <p>18-5361 TAPA DISTRIBUIDOR Reemplaza: 3854260 Para: 3.0L Delco EST "Tapa modulo"</p>	 <p>18-5362 TAPA DISTRIBUIDOR Reemplaza: 3854331 Para: 4.3L V6 Delco EST "Tapa modulo"</p>	 <p>18-5369 TAPA DISTRIBUIDOR Reemplaza: 835702 con junta 18-5399</p>
 <p>18-5375 TAPA DISTRIBUIDOR Reemplaza: 841244</p>	 <p>18-5393 TAPA DISTRIBUIDOR Reemplaza: 241669</p>	 <p>18-5473 TAPA DISTRIBUIDOR Tapa distribuidor negra con terminales macho para distribuidores flame thrower</p>	 <p>18-5474 TAPA DISTRIBUIDOR Tapa distribuidor roja con terminales macho para distribuidores flame thrower</p>	 <p>18-29417 TAPA DISTRIBUIDOR Reemplaza: Mallory 270B Para: Mallory 6 cilindro</p>

 <p>18-5243 TAPA DISTRIBUIDOR Reemplaza: 3859019 Para: Distribuidores Delco HVS V-6</p>	 <p>18-5244 TAPA DISTRIBUIDOR Reemplaza: 3858975 Para: Distribuidores Delco HVS V-8</p>	 <p>18-7492 BOBINA Reemplaza: 3854161 Para: Aplicaciones 1996</p>	 <p>18-7493 BOBINA Reemplaza: 3859078 Para: 8.1L 2001-2007</p>	 <p>18-5745 BOBINA ENCENDIDO Reemplaza: 3287677 Para: AQ171A, AQ171C 251A (1988-92)</p>
 <p>18-7648 BOBINA ENCENDIDO Reemplaza: 3861267 Para: 8.1Gi-A, 8.1Gi-B, 8.1Gi-BF, 8.1Gi-C, 8.1Gi-CF, 8.1Gi-D, 8.1Gi-DF, 8.1GSI-A, 8.1GXI-A, 8.1GXI-AF, 8.1GXI-B, 8.1GXI-BF, 8.1GXI-C</p>	 <p>18-5433 BOBINA ENCENDIDO Reemplaza: 835998 Usa resistencia externa</p>	 <p>18-5436 BOBINA ENCENDIDO 3.0 ohm Reemplaza: 35254 Usa resistencia externa</p>	 <p>18-5437 BOBINA ENCENDIDO Reemplaza: 3852217 Metalica - 12 Volt Usa resistencia externa (Para todas las aplicaciones) Para: Para colas 1990 ant. con punto de encendido</p>	 <p>18-5467 BOBINA ENCENDIDO Reemplaza: 21436799 Para: Motores equipados con distribuidor delco HVS con soporte extensible</p>
 <p>18-5443 BOBINA ENCENDIDO Reemplaza: 3854002 3.0L/4.3L/5.7L/7.4L</p>	 <p>18-5107-1 MODULO ENCENDIDO Reemplaza: 3854003</p>	 <p>18-5464 MODULO ENCENDIDO Para: Sierra 18-5481, 18-5482 y 18-5483 Billet alto rendimiento DISTRIBUIDOR ELECTRÓNICO (excepto HEI/EST)</p>	 <p>18-5108 SENSOR Reemplaza 3854001 Para: GM EST</p>	 <p>18-7757 SENSOR DE POSICIÓN Reemplaza: 3855296 Para: 1995-2001</p>
 <p>18-7642 SENSOR DELCO Reemplaza: 3863130 Para: 3.0, 4.3, 5.0, 5.7L modelos (2002-07)</p>	 <p>18-7643 SENSOR CIGÜEÑAL 3-Pasador Reemplaza: 3859082 Para: 8.1Gi-A, 8.1Gi-B, 8.1Gi-BF, 8.1Gi-C, 8.1Gi-CF, 8.1Gi-D, 8.1Gi-DF, 8.1GSI-A, 8.1GXI-A, 8.1GXI-AF, 8.1GXI-B, 8.1GXI-BF, 8.1GXI-C, 8.1Gi-E, 8.1Gi-EF, 8.1GXI-D, 8.1GXI-DF, 8.1OSi-A, 8.1OSi-AF, 8.1Gi-E, 8.1GXII-D (2001-07)</p>	 <p>18-7706 SENSOR POSICIÓN CIGÜEÑAL Reemplaza: 3858979 Para: modelos 4.3, 5.0, 5.7L</p>	 <p>18-7708 SENSOR POSICIÓN CIGÜEÑAL Reemplaza: 3808516 Para: Mayoría 8.1L</p>	

CARACTERÍSTICAS

- ★ Relleno con aceite para mejor refrigeración y gran durabilidad
- ★ Baja resistencia que produce una gran intensidad para un mejor encendido y economía de combustible
- ★ Mas hilos internos maximizan la potencia y la fiabilidad sobre el rango de las RPM
- ★ Se ajusta a los soportes existentes para una fácil instalación

 <p>18-5466 BOBINA ENCENDIDO ALTO RENDIMIENTO 1.5 ohm (filtro aceite), negro - 8 cilindro: Flame-Thrower 40,000 volt bobina. ★ Diseñado para uso con kit de encendido de con electrónica original ★ Puede ser usado con otros sistemas de encendido</p>	 <p>18-5469 BOBINA ENCENDIDO ALTO RENDIMIENTO 3.0 ohm (aceite filtro), negro - 4 & 6 cilindro: Flame-Thrower 40,000 volt bobina. ★ Diseñado para uso con kit de encendido de con electrónica original ★ Puede ser usado con otros sistemas de encendido</p>	 <p>18-5472 BOBINA ENCENDIDO ALTO RENDIMIENTO 0.6 ohm (filtro aceite), black - 4, 6, & 8 cilindro: Flame-Thrower 45,000 volt bobina. ★ Resistencia bobina 0.6 ohm diseñada para utilizar con kits de altas prestaciones. ★ Compatible con sistemas de descarga.</p>
---	--	---

Ref #	Descripción	Bobina recomendada	Resistencia Ohms	Ref #	Descripción	Bobina recomendada	Resistencia Ohms
18-5294	Kit conversión electrónica	18-5469	3.0	18-5286	Kit conversión electrónica altas prest.	18-5472	0.6
18-5295	Kit conversión electrónica	18-5469	3.0	18-5289	Kit conversión electrónica altas prest.	18-5472	0.6
18-5299	Kit conversión electrónica	18-5466	1.5	18-5483	Distribuidor Flame-Thrower	18-5472	0.6



FEATURES

- ★ **Ajuste del encendido**
- ★ **Larga vida**
- ★ **Máxima potencia y prestaciones**

Standard Rotation **CCW Rotation**

If flywheel rotates to the left & distributor rotor turns clockwise

If flywheel rotates to the right & distributor turns counter clockwise

Labels: Distributor, Flywheel

18-5483
DISTRIBUIDOR ELECTRÓNICO ALTAS PREST.
Para: Chevrolet Marine bloques grandes y pequeños (Altura cubierta standard)
Reemplaza kit tapa/rotor 18-5266

18-5498-2
DISTRIBUIDOR
Reemplaza: 9-26307; Mallory YLM624BV
Para GM V8, 482, 502, 540 CID (Excepto 348, 409 y bloque grande para cubierta alta)

18-5475
DISTRIBUIDOR
Para: 4 Cil GM con Delco EST encendido 18-5280

18-5476
DISTRIBUIDOR
Para: Motores GM V6 con encendido Delco EST HEI kit encendido 18-5278

18-5484-1
DISTRIBUIDOR ELECTRÓNICO (Último modelo HEI)
Reemplaza: 3857449
Para rotación convencional V8/LH 262-454 & 502 (Excepto 348/409 y bloques grandes)
• Diseñado como reemplazo de enchufe para distribuidores de combustible con sistemas de inyección GM-style Tune-Up Kit 18-5281

— CONTIENE —
Descripción Ref #
Tapa distribuidor 18-5354
Rotor 18-5405

18-5494-2
DISTRIBUIDOR ELECTRÓNICO
Reemplaza: Mallory YLM624AV
Rotación convencional
Para todos Chevrolet V8 incluye 482, 502, 540 CID (Excepto 348,409 & bloque grande para cubierta alta)

— CONTIENE —

Ref #	Descripción
18-5376	Tapa distribuidor
18-5488	Modulo
18-5404-1	Rotor

18-5480
KIT CONVERSIÓN ENCENDIDO
Para: GM SB & BB con altura de cubierta standard

— CONTIENE —

Ref #	Descripción
18-5472	Bobina
18-8803-2	Cableado
18-5483	Distribuidor

18-5477
DISTRIBUIDOR ELECTRÓNICO
Para: Motores Ford 302 V-8
Reemplaza Kit tapa/Rotor 18-5266



18-5478
DISTRIBUIDOR ELECTRÓNICO
Para: motores Chrysler LA series V-8
Reemplaza kit tapa/Rotor 18-5266



18-5479
DISTRIBUIDOR ELECTRÓNICO
Para: Motor GM V-8 -rotación reverso
Reemplaza kit tapa/Rotor 18-5266

Ignitor® II

ELECTRONIC IGNITION

CARACTERÍSTICAS

- ★ *Ajuste al pico motor.*
- ★ *Desarrolla de media, 4 veces más energía entre 3.000 y 5.000 RPM.*
- ★ *Larga vida.*
- ★ *usar con 18-5472 para un óptimo rendimiento.*



18-5240
KIT CONVERSIÓN ELECTRÓNICA ALTO RENDIMIENTO
Para: Distribuidores prestolite IDU-7801



18-5286
KIT CONVERSIÓN ELECTRÓNICA ALTO RENDIMIENTO
Para: 6 Cilindros distribuidores Delco



18-5288
KIT ELECTRÓNICO ALTO RENDIMIENTO
Para: Mayoría Distribuidores Prestolite V-8 con tapa fijada con clips



18-5289
KIT CONVERSIÓN ELECTRÓNICA ALTO RENDIMIENTO
Para: Mayoría de distribuidores Prestolite V-8 con tapa fijada con tornillos

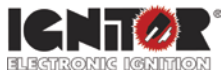

CARACTERÍSTICAS

- ★ *Reemplaza platinos y condensador par aun buen encendido.*
- ★ *Usa bobina, tapa y rotor standard.*
- ★ *Fácil de instalar, una pieza, 2-conexiones de cables.*
- ★ *Tolerancia de 1/4° en el encendido de 0 a 6000 RPM.*

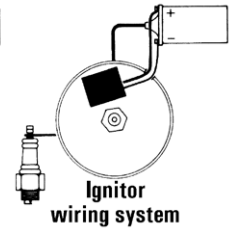
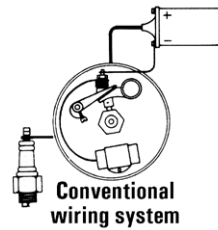

18-5239
KIT CONVERSIÓN ELECTRÓNICA
Para: Distribuidores Prestolite IDU-7801



18-5292
KIT CONVERSIÓN ELECTRÓNICA
Para: 4 Cilindro Volvo AQ Modelos con encendido Bosch (Dist # 0231178017)



18-5294
KIT CONVERSIÓN ELECTRÓNICA
Para: (6 Cil.) distribuidores Delco



18-5295
KIT CONVERSIÓN ELECTRÓNICA
Para: Mayoría 4 Cil. Prestolite distribuidores (excepto IBM7026) Para: Onan, Universal, Waukesha, Wisconsin



18-5299D
KIT CONVERSIÓN ELECTRÓNICA
Para: 8 (Cil.) AQ200A, B, AQ225A, B y Todos 8 Cil. con Prestolite Dist # IBM-7013A Usar con rotor 18-5403 style

Display Package

CABLES DE ENCENDIDO

Sierra MAGFORCE Cables de encendido electrónica protege todos tus dispositivos electrónicos y los controles electrónicos del motor de RFI y EMI, además de ofrecer la máxima cantidad de tensión. Ajuste exacto el diseño asegura una fácil instalación - servicio gratuito.

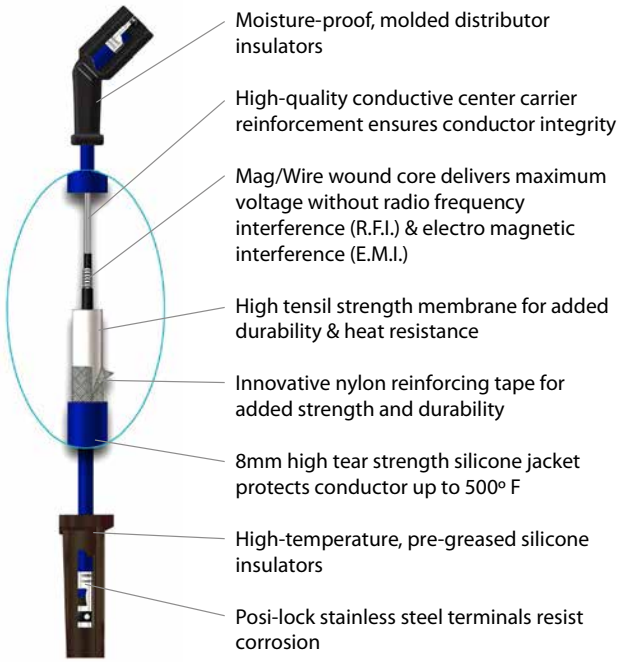

APLICACIONES CABLES ENCENDIDO VOLVO MARINE					
Modelo	Cil.	Distribuidor	Año inicio	Año final	enchufe cable
AQ115A, B	4	Volvo	1969	1975	18-28050
AQ120B	4	Volvo	1977	1980	18-8813-1
AQ125A, B	4	Volvo	1981	1985	18-8813-1
AQ130A, B, C, D	4	Volvo	1968	1977	18-28050
AQ131A, B, C, D	4	Volvo	1985	1989	18-8813-1
AQ140A	4	Volvo	1975	1979	18-8813-1
AQ145A, B	4	Volvo	1979	1985	18-8813-1
AQ151A, B, C	4	Volvo	1985	1989	18-8813-1
AQ175A	6	Volvo	1981	1985	18-8801-1
AQ190A	8	Volvo	1976	1977	18-8802-1
AQ200B	8	Mallory (tapa alta)	1974	1976	18-8802-1
AQ200B	8	Mallory (tapa plana)	1974	1976	18-8823-1
AQ200C	8	Mallory (tapa alta)	1976	1977	18-8802-1
AQ200C	8	Mallory (tapa alta)	1976	1977	18-8823-1
AQ205A	6	Volvo	1988	1989	18-8801-1
AQ211A	8	Volvo	1986	1989	18-8802-1
AQ225B	8	Mallory (tapa alta)	1974	1976	18-8802-1
AQ225B	8	Mallory (tapa plana)	1974	1976	18-8823-1

APLICACIONES CABLES ENCENDIDO VOLVO MARINE					
Modelo	Cil.	Distribuidor	Año inicio	Año final	enchufe cable
AQ231A, B	8	Volvo	1986	1989	18-8802-1
AQ240A	8	Volvo	1976	1977	18-8802-1
AQ255A	8	Mallory (Tapa plana)	1977	1978	18-8823-1
AQ255B	8	Mallory (tapa alta)	1978	1978	18-8802-1
AQ255B	8	Mallory (Tapa alta)	1978	1978	18-8823-1
AQ260A	8	Mallory (Tapa alta)	1979	1985	18-8802-1
AQ260A	8	Mallory (tapa plana)	1979	1985	18-8823-1
AQ260B	8	Mallory (tapa alta)	1985	1986	18-8802-1
AQ271A, B, C, D	8	Volvo	1986	1989	18-8802-1
AQ280A	8	Mallory (tapa alta)	1978	1979	18-8802-1
AQ280A	8	Mallory (tapa alta)	1978	1979	18-8823-1
AQ290A	8	Mallory (tapa alta)	1979	1985	18-8802-1
AQ290A	8	Mallory (Flat Cap)	1979	1985	18-8823-1
AQ311A, B	8	Volvo	1986	1989	18-8802-1
BB140A	4	Volvo	1975	1979	18-8813-1
BB145A	4	Volvo	1979	1985	18-8813-1
BB225A, AV, B, C	8	Volvo	1973	1977	18-8802-1
BB231A	8	Volvo	1987	1987	18-8802-1

APLICACIÓN CONTINUAN EN LA SIGUIENTE PÁGINA

APLICACIONES CABLES ENCENDIDO VOLVO MARINE					
Modelo	Cil.	Distribuidor	Año inicio	Año final	enchufe cable
BB260A, AV, B, C	8	Volvo	1978	1985	18-8802-1
BB261A	8	Volvo	1988	1989	18-8802-1
230A, B	4	Volvo	1989	1992	18-8813-1
250A, B	4	Volvo	1989	1992	18-8813-1
432A	6	Delco EST	1992	1993	18-8835-1
434A	6	Delco EST	1992	1993	18-8835-1
3.0GLM	4	Delco EST	1993	1994	18-8833-1
3.0GLM	4	Delco EST	2002	2004	18-8833-1
3.0GLP	4	Delco EST	2002	2010	18-8833-1
3.0GSM	4	Delco EST	1994	2002	18-8833-1
3.0GSP	4	Delco EST	1993	2002	18-8833-1
3.0GX1	4	Delco EST	2008	2009	18-8833-1
4.3GI	6	Delco EST	1994	2000	18-8835-1
4.3GL	6	Delco EST	1993	2010	18-8835-1
4.3GS	6	Delco EST	1993	1999	18-8835-1
4.3GX1	6	Delco HVS	2001	2015	18-8829-1
4.3GX1	6	Delco EST	2001	2002	18-8835-1
4.3GXIE	6	Delco HVS	2009	2015	18-8829-1
4.3SI	6	Delco HVS	2001	2009	18-8829-1
4.3SI-BF	6	Delco HVS	2001	2002	18-8829-1
5.0FI	8	Ford	1994	1996	18-8820-1
5.0FL	8	Prestolite	1994	1996	18-8802-1
5.0GI	8	Delco EST	1997	2000	18-8836-1
5.0GL	8	Prestolite	1997	2001	18-8802-1
5.0GL	8	Delco EST	2001	2006	18-8836-1
5.0GX1	8	Delco HVS	2001	2015	18-8828-1
5.0GX1-A	8	Delco EST	2001	2002	18-8836-1
5.0GXIC	8	Delco HVS	2007	2009	18-8828-1
5.0GXIE	8	Delco HVS	2007	2015	18-8828-1
5.0OSI	8	Delco HVS	2001	2009	18-8828-1
5.0OSIE	8	Delco HVS	2008	2009	18-8828-1
5.7GI	8	Delco EST	1993	1997	18-8836-1
5.7Gi	8	Delco HVS	2001	2015	18-8828-1
5.7GI	8	Delco EST	2004	2005	18-8836-1
5.7GiC	8	Delco HVS	2008	2009	18-8828-1
5.7GiCE	8	Delco HVS	2008	2009	18-8828-1
5.7GiE	8	Delco HVS	2007	2015	18-8828-1
5.7GIL	8	Delco HVS	2002	2009	18-8828-1
5.7GIL-A	8	Delco EST	2001	2001	18-8836-1
5.7GL	8	Prestolite	1993	1997	18-8802-1
5.7GL	8	Delco EST	1993	1997	18-8836-1
5.7GL	8	Delco EST	2001	2004	18-8836-1
5.7GL-A	8	Mallory	2001	2001	18-8802-1
5.7GSI	8	Delco EST	1996	2001	18-8836-1
5.7GSP	8	Prestolite	1996	2000	18-8802-1

APLICACIONES CABLES ENCENDIDO VOLVO MARINE					
Modelo	Cil.	Distribuidor	Año inicio	Año final	enchufe cable
5.7GX1	8	Delco HVS	2001	2015	18-8828-1
5.7GX1-A, B	8	Delco EST	2000	2002	18-8836-1
5.7GXIC	8	Delco HVS	2007	2008	18-8828-1
5.7GXICE	8	Delco HVS	2007	2010	18-8828-1
5.7GXIE	8	Delco HVS	2007	2015	18-8828-1
5.7GXIL	8	Delco HVS	2001	2008	18-8828-1
5.7GXIL-A, B	8	Delco EST	2000	2002	18-8836-1
5.7OSi	8	Delco HVS	2001	2009	18-8828-1
5.7OSIE	8	Delco HVS	2008	2009	18-8828-1
5.7OSXI	8	Delco HVS	2001	2009	18-8828-1
5.7OSXIE	8	Delco HVS	2008	2009	18-8828-1
5.8FI	8	Ford	1994	1996	18-8820-1
5.8FL	8	Prestolite	1994	1996	18-8803-1
5.8FSI	8	Prestolite	1994	1996	18-8803-1
7.4GI	8	Delco EST	1994	2000	18-8836-1
7.4GL	8	Prestolite	1993	1997	18-8802-1
7.4GLI	8	Prestolite	1993	1996	18-8802-1
7.4GLP	8	Prestolite	1993	1997	18-8802-1
7.4GLP	8	Prestolite	1994	1997	18-28051
7.4GLP	8	Delco EST	1995	1996	18-8836-1
7.4GSI	8	Delco EST	1994	2000	18-8836-1
8.1Gi-A	8	Distributorless	1999	2015	18-8838-1
8.1GiC	8	Distributorless	2007	2015	18-8838-1
8.1GiCE	8	Distributorless	2007	2015	18-8838-1
8.1GiE	8	Distributorless	2007	2015	18-8838-1
8.1GiL	8	Distributorless	2000	2008	18-8838-1
8.1GSi	8	Distributorless	2000	2001	18-8838-1
8.1GX1	8	Distributorless	2001	2015	18-8838-1
8.1GXIE	8	Distributorless	2007	2015	18-8838-1
8.1GXil	8	Distributorless	2001	2008	18-8838-1
8.1IPSC	8	Distributorless	2008	2015	18-8838-1
8.1OSI	8	Distributorless	2003	2009	18-8838-1
8.1OSiE	8	Distributorless	2008	2009	18-8838-1
8.2GLI	8	Prestolite	1993	1994	18-8803-1
8.2GLP	8	Prestolite	1993	1994	18-8803-1
8.2GSI	8	Delco EST	1995	2000	18-8836-1
DPX375	8	Distributorless	2000	2002	18-8838-1
DPX385	8	Delco EST	1996	2000	18-8836-1
DPX415	8	Delco EST	1996	2000	18-8836-1
DPX420	8	Distributorless	2000	2002	18-8838-1
V6-200	6	Delco HVS	2012	2015	18-8828-1
V6-225	6	Delco HVS	2012	2015	18-8828-1
V8-270	8	Delco HVS	2012	2015	18-8829-1
V8-300	8	Delco HVS	2012	2015	18-8829-1
V8-320	8	Delco HVS	2012	2015	18-8829-1



CABLES BATERÍA
Con cables soldados para
3/8" .

Ref No.	Tam	Color	Cal
BC88523	2'	rojo	4
BC88533	2'	negro	4
BC88543	4'	rojo	2
BC88553	4'	negro	2
BC88563	6'	rojo	2
BC88573	6'	negro	2
BC88583	8'	rojo	1
BC88593	8'	negro	1



18-5225
KIT CABLE BUJÍAS

Reemplaza: Mercury 84-99215A26,
84-813706A26

Kit incluye 25 pies de cable de 7mm Hypalon de alma de cobre y un amplio surtido de 3 terminales.

 <p>18-5226 CABLE ENCENDIDO Alma metálica 100' bobina 7mm Hypalon</p>	 <p>18-26810 GM HEI 4 TERMINAL PIGTAIL Para: GM HEI Distribuidores con 4 terminales</p>	 <p>18-26811 GM HEI 2 TERMINAL PIGTAIL Para: GM HEI Distribuidores con 2 terminales</p>	 <p>18-26812 CONECTOR BOBINA HEI</p>	 <p>18-26813 CONECTOR BOBINA HEI</p>
<p>PACK. DE 10</p>  <p>18-5224 18-5224-9① CABLE TERMINAL ENCENDIDO Reemplaza: Mercury 20121 OMC 510364</p>	<p>PACK. DE 10</p>  <p>18-5750 18-5750-9① TAPA BUJÍAS UNIVERSAL Suministrado completo con conector terminal Replaces: OMC 581027, 580339</p>	 <p>18-5752 TAPA BUJÍAS UNIVERSAL 8mm</p>	 <p>18-5657 TAPA BUJÍAS UNIVERSAL Reemplaza: 855798 Para: Mayoría motores Volvo gas & diesel</p>	

① Precio por pack

APLICACIÓN ENCENDIDO VOLVO PENTA

Modelo	Distribuidor	Kit cable bujías	Tapa distrib.	Rotor	bobina picado	ICM	Bobina encendido	Condensador	Puntos de contacto	Kit encendido
AQ100	BOSCH	-	18-5357	18-5428	N/D	N/D	18-5436	18-5342	18-5306	-
AQ110	BOSCH	-	18-5357	18-5428	N/D	N/D	18-5436	18-5342	18-5306	-
AQ115A	0231153010	18-28050	18-5357	18-5428	N/D	N/D	18-5436	-	18-5305	-
AQ115A	0231153012	18-28050	18-5356	18-5428	N/D	N/D	18-5436	-	18-5305	-
AQ115B	0231153010	18-28050	18-5357	18-5428	N/D	N/D	18-5436	-	18-5305	-
AQ115B	0231153012	18-28050	18-5356	18-5428	N/D	N/D	18-5436	-	18-5305	-
AQ120	BOSCH	-	18-5357	18-5428	N/D	N/D	18-5436	18-5342	18-5306	-
AQ120B	0231178017	18-8813-1	18-5358	18-5428	N/D	N/D	18-5436	18-5349	18-5305	18-5284
AQ120B	0231178016	18-8813-1	18-5356	18-5428	N/D	N/D	18-5436	18-5349	18-5305	18-5284
AQ120B	0231178018	18-8813-1	18-5356	18-5428	N/D	N/D	18-5436	18-5349	18-5305	18-5284
AQ125A	TODOS	18-8813-1	18-5358	18-5428	N/D	N/D	18-5436	18-5349	18-5305	18-5284
AQ125B	TODOS	18-8813-1	18-5358	18-5428	N/D	N/D	18-5436	18-5349	18-5305	18-5284
AQ130A	0231153010	18-28050	18-5357	18-5428	N/D	N/D	18-5436	-	18-5305	-
AQ130A	0231153012	18-28050	18-5356	18-5428	N/D	N/D	18-5436	-	18-5305	-
AQ130B	0231153010	18-28050	18-5357	18-5428	N/D	N/D	18-5436	-	18-5305	-
AQ130B	0231153012	18-28050	18-5356	18-5428	N/D	N/D	18-5436	-	18-5305	-
AQ130C	0231153010	18-28050	18-5357	18-5428	N/D	N/D	18-5436	-	18-5305	-
AQ130C	0231153012	18-28050	18-5356	18-5428	N/D	N/D	18-5436	-	18-5305	-
AQ130D	0231153010	18-28050	18-5357	18-5428	N/D	N/D	18-5436	-	18-5305	-
AQ130D	0231153012	18-28050	18-5356	18-5428	N/D	N/D	18-5436	-	18-5305	-
AQ131A	TODOS	18-8813-1	18-5358	18-5428	N/D	N/D	18-5436	-	18-5305	-
AQ131B	TODOS	18-8813-1	18-5358	18-5428	N/D	N/D	18-5436	-	18-5305	-
AQ131C	TODOS	18-8813-1	18-5358	18-5428	N/D	N/D	18-5436	-	18-5305	-
AQ131D	TODOS	18-8813-1	18-5358	18-5428	N/D	N/D	18-5436	-	18-5305	-
AQ140A	0231178017	18-8813-1	18-5358	18-5428	N/D	N/D	18-5436	18-5349	18-5305	18-5284
AQ140A	0231178016	18-8813-1	18-5356	18-5428	N/D	N/D	18-5436	18-5349	18-5305	18-5284
AQ140A	0231178018	18-8813-1	18-5356	18-5428	N/D	N/D	18-5436	18-5349	18-5305	18-5284
AQ145A	TODOS	18-8813-1	18-5358	18-5428	N/D	N/D	18-5436	18-5349	18-5305	18-5284
AQ145B	TODOS	18-8813-1	18-5358	18-5428	N/D	N/D	18-5436	18-5349	18-5305	18-5284
AQ151A	TODOS	18-8813-1	18-5358	18-5428	N/D	N/D	18-5436	18-5349	18-5305	18-5284
AQ151B	TODOS	18-8813-1	18-5358	18-5428	N/D	N/D	18-5436	18-5349	18-5305	18-5284
AQ151C	TODOS	18-8813-1	18-5358	18-5428	N/D	N/D	18-5436	18-5349	18-5305	18-5284

APLICACIONES CONTINUAN EN LA SIGUIENTE PAGINA

APLICACIÓN ENCENDIDO VOLVO PENTA (Cont.)

Modelo	Distribuidor	Kit cable bujías	Tapa distrib.	Rotor	bobina picado	ICM	Bobina encendido	Condensador	Puntos de contacto	Kit encendido
AQ165A	0231116054		18-5393	18-5428	N/D	N/D		-	-	-
AQ165A	0231116060		18-5393	18-5428	N/D	N/D		-	-	-
AQ165A	0231121008		18-5393	18-5428	N/D	N/D		-	18-5305	-
AQ165A	0231311002		18-5394	18-5428	N/D	N/D		-	18-5319	-
AQ170A	0231116054		-	18-5428	N/D	N/D		-	-	-
AQ170A	0231116060		-	18-5428	N/D	N/D		-	-	-
AQ170A	0231121008		-	18-5428	N/D	N/D		-	18-5305	-
AQ170A	0231311002		-	-	N/D	N/D		-	18-5319	-
AQ170B	0231116054		-	18-5428	N/D	N/D		-	-	-
AQ170B	0231116060		-	18-5428	N/D	N/D		-	-	-
AQ170B	0231121008		-	18-5428	N/D	N/D		-	18-5305	-
AQ170B	0231311002		-	-	N/D	N/D		-	18-5319	-
AQ170C	0231116054		18-5393	18-5428	N/D	N/D		-	-	-
AQ170C	0231121008		-	18-5428	N/D	N/D		-	18-5305	-
AQ171A	TODOS		-	-	N/D	N/D		N/D	N/D	-
AQ171C	TODOS		-	-	N/D	N/D		N/D	N/D	-
AQ175A	TODOS	18-8801-1	18-5369	18-5425	N/D	N/D	18-5433	18-5345	18-5303	18-5264
AQ190A	TODOS	18-8802-1	18-5369	18-5425	N/D	N/D		18-5345	18-5303	18-5264
AQ200B	MALLORY TAPA PLANA	18-8823-1	18-5375	18-5411	N/D	N/D		18-5338	18-5314	18-5256
AQ200B	MALLORY TAPA ALTA	18-8802-1	18-5352	18-5403	N/D	N/D		18-5345	18-5303	18-5260
AQ200C	MALLORY TAPA PLANA	18-8823-1	18-5375	18-5411	N/D	N/D	18-5433	18-5338	18-5314	18-5256
AQ200C	MALLORY TAPA ALTA	18-8802-1	18-5352	18-5403	N/D	N/D	18-5433	18-5345	18-5303	18-5260
AQ200D	S/N 20459 & INF		18-5369	18-5425	N/D	N/D	18-5433	18-5345	18-5303	18-5264
AQ200D	S/N 20460 & SUP		18-5352	18-5403	N/D	N/D	18-5433	18-5345	18-5303	18-5260
AQ200F	TODOS		18-5352	18-5403	N/D	N/D	18-5433	18-5345	18-5303	18-5260
AQ205A	TODOS	18-8801-1	18-5353	18-5403	N/D	N/D		-	-	-
AQ211A	TODOS	18-8802-1	18-5352	18-5403	N/D	N/D	18-5433	18-5345	18-5303	18-5260
AQ225B	MALLORY TAPA PLANA	18-8823-1	18-5375	18-5411	N/D	N/D		18-5338	18-5314	18-5256
AQ225B	MALLORY TAPA ALTA	18-8802-1	18-5352	18-5403	N/D	N/D		18-5345	18-5303	18-5260
AQ225C	TODOS		18-5375	18-5411	N/D	N/D	18-5433	18-5338	18-5314	18-5256
AQ225D	S/N 20459 & INF		18-5369	18-5425	N/D	N/D	18-5433	18-5345	18-5303	18-5264
AQ225D	S/N 20460 & SUP		18-5352	18-5403	N/D	N/D	18-5433	18-5345	18-5303	18-5260
AQ225E	TODOS		18-5352	18-5403	N/D	N/D	18-5433	18-5345	18-5303	18-5260
AQ225F	TODOS		18-5352	18-5403	N/D	N/D	18-5433	18-5345	18-5303	18-5260
AQ231A	TODOS	18-8802-1	18-5352	18-5403	N/D	N/D	18-5433	18-5345	18-5303	18-5260
AQ231B	TODOS	18-8802-1	18-5352	18-5403	N/D	N/D	18-5433	18-5345	18-5303	18-5260
AQ240A	TODOS	18-8802-1	18-5369	18-5403	N/D	N/D		18-5345	18-5303	18-5260
AQ255A	MALLORY TAPA PLANA	18-8823-1	18-5375	18-5411	N/D	N/D	18-5433	18-5338	18-5314	18-5256
AQ255B	MALLORY TAPA PLANA	18-8823-1	18-5375	18-5411	N/D	N/D	18-5433	18-5338	18-5314	18-5256
AQ255B	MALLORY TAPA ALTA	18-8802-1	18-5352	18-5403	N/D	N/D	18-5433	18-5345	18-5303	18-5260
AQ260A	MALLORY TAPA PLANA	18-8823-1	18-5375	18-5411	N/D	N/D	18-5433	18-5338	18-5314	18-5256
AQ260A	MALLORY TAPA ALTA	18-8802-1	18-5352	18-5403	N/D	N/D	18-5433	18-5345	18-5303	18-5260
AQ260B	MALLORY TAPA ALTA	18-8802-1	18-5352	18-5403	N/D	N/D	18-5433	18-5345	18-5303	18-5260
AQ271A	TODOS	18-8802-1	18-5352	18-5403	N/D	N/D	18-5433	-	-	-
AQ271B	TODOS	18-8802-1	18-5352	18-5403	N/D	N/D		-	-	-
AQ271C	TODOS	18-8802-1	18-5352	18-5403	N/D	N/D		-	-	-
AQ271D	TODOS	18-8802-1	18-5352	18-5403	N/D	N/D		-	-	-
AQ280A	MALLORY TAPA PLANA	18-8823-1	18-5375	18-5411	N/D	N/D	-	18-5338	18-5314	18-5256
AQ280A	MALLORY TAPA ALTA	18-8802-1	18-5352	18-5403	N/D	N/D	-	18-5345	18-5303	18-5260
AQ290A	MALLORY TAPA PLANA	18-8823-1	18-5375	18-5411	N/D	N/D	18-5433	18-5338	18-5314	18-5256
AQ290A	MALLORY TAPA ALTA	18-8802-1	18-5352	18-5403	N/D	N/D	18-5433	18-5345	18-5303	18-5260
AQ311A	TODOS	18-8802-1	18-5352	18-5403	N/D	N/D		-	-	-
AQ311B	TODOS	18-8802-1	18-5352	18-5403	N/D	N/D		-	-	-
AQ60F	BOSCH	-	18-5357	18-5428	N/D	N/D	18-5436	18-5342	18-5306	-

APLICACIONES CONTINUAN EN LA SIGUIENTE PAGINA

APLICACIÓN ENCENDIDO VOLVO PENTA (Cont.)

Modelo	Distribuidor	Kit cable bujías	Tapa distrib.	Rotor	bobina picado	ICM	Bobina encendido	Condensador	Puntos de contacto	Kit encendido
AQ90	BOSCH	-	18-5357	18-5428	N/D	N/D	18-5436	18-5342	18-5306	-
AQ95	BOSCH	-	18-5357	18-5428	N/D	N/D	18-5436	18-5342	18-5306	-
AQ95A	BOSCH	-	18-5357	18-5428	N/D	N/D	18-5436	18-5342	18-5306	-
BB100	BOSCH	-	18-5357	18-5428	N/D	N/D	18-5436	18-5342	18-5306	-
BB115A	0231153010	18-28050	18-5357	18-5428	N/D	N/D	18-5436	-	18-5305	-
BB115A	0231153012	18-28050	18-5356	18-5428	N/D	N/D	18-5436	-	18-5305	-
BB115B	0231153010	18-28050	18-5357	18-5428	N/D	N/D	18-5436	-	18-5305	-
BB115B	0231153012	18-28050	18-5356	18-5428	N/D	N/D	18-5436	-	18-5305	-
BB115C	0231153010	18-28050	18-5357	18-5428	N/D	N/D	18-5436	-	18-5305	-
BB115C	0231153012	18-28050	18-5356	18-5428	N/D	N/D	18-5436	-	18-5305	-
BB140A	0231178017	18-8813-1	18-5358	18-5428	N/D	N/D	18-5436	18-5349	18-5305	18-5284
BB140A	0231178016	18-8813-1	18-5356	18-5428	N/D	N/D	18-5436	18-5349	18-5305	18-5284
BB140A	0231178018	18-8813-1	18-5356	18-5428	N/D	N/D	18-5436	18-5349	18-5305	18-5284
BB145A	TODOS	18-8813-1	18-5358	18-5428	N/D	N/D	18-5436	18-5349	18-5305	18-5284
BB165A	0231116054		18-5393	18-5428	N/D	N/D		-	-	-
BB165A	0231116060		18-5393	18-5428	N/D	N/D		-	-	-
BB165A	0231121008		18-5393	18-5428	N/D	N/D		-	18-5305	-
BB165A	0231311002		18-5394	18-5428	N/D	N/D		-	18-5319	-
BB170A	0231116054		18-5393	18-5428	N/D	N/D		-	-	-
BB170A	0231116060		18-5393	18-5428	N/D	N/D		-	-	-
BB170A	0231121008		18-5393	18-5428	N/D	N/D		-	18-5305	-
BB170A	0231311002		18-5394	18-5428	N/D	N/D		-	18-5319	-
BB170B	0231116054		18-5393	18-5428	N/D	N/D		-	-	-
BB170B	0231116060		18-5393	18-5428	N/D	N/D		-	-	-
BB170B	0231121008		18-5393	18-5428	N/D	N/D		-	18-5305	-
BB170B	0231311002		18-5394	18-5428	N/D	N/D		-	18-5319	-
BB170C	0231116054		18-5393	18-5428	N/D	N/D		-	-	-
BB170C	0231116060		18-5393	18-5428	N/D	N/D		-	-	-
BB170C	0231121008		18-5393	18-5428	N/D	N/D		-	18-5305	-
BB170C	0231311002		18-5394	18-5428	N/D	N/D		-	18-5319	-
BB225A	TODOS	18-8802-1	18-5352	18-5403	N/D	N/D	18-5433	18-5345	18-5303	18-5260
BB225AV	TODOS	18-8802-1	18-5352	18-5403	N/D	N/D	18-5433	18-5345	18-5303	18-5260
BB225B	TODOS	18-8802-1	18-5352	18-5403	N/D	N/D	18-5433	18-5345	18-5303	18-5260
BB225C	TODOS	18-8802-1	18-5352	18-5403	N/D	N/D	18-5433	18-5345	18-5303	18-5260
BB231A	TODOS	18-8802-1	18-5352	18-5403	N/D	N/D	18-5433	18-5345	18-5303	18-5260
BB260A	TODOS	18-8802-1	18-5352	18-5403	N/D	N/D	18-5433	18-5345	18-5303	18-5260
BB260AV	TODOS	18-8802-1	18-5352	18-5403	N/D	N/D	18-5433	18-5345	18-5303	18-5260
BB260B	TODOS	18-8802-1	18-5352	18-5403	N/D	N/D	18-5433	18-5345	18-5303	18-5260
BB260C	TODOS	18-8802-1	18-5352	18-5403	N/D	N/D	18-5433	18-5345	18-5303	18-5260
BB261A	TODOS	18-8802-1	18-5352	18-5403	N/D	N/D	18-5433	18-5345	18-5303	18-5260
BB30	BOSCH	-	18-5357	18-5428	N/D	N/D	18-5436	18-5342	18-5306	-
MB10A	TODOS		-	18-5428	N/D	N/D	18-5436	-	18-5305	-
MB18	BOSCH	-	18-5357	18-5428	N/D	N/D	18-5436	18-5342	18-5306	-
MB18F	BOSCH	-	18-5357	18-5428	N/D	N/D	18-5436	18-5342	18-5306	-
MB20A	TODOS		18-5356	18-5428	N/D	N/D	18-5436	-	18-5305	-
MB20B	0231110043	-	18-5357	18-5428	N/D	N/D	18-5436	18-5342	18-5306	-
MB20B	0231178005		18-5356	18-5428	N/D	N/D	18-5436	-	18-5305	-
MB20C	0231110043	-	18-5357	18-5428	N/D	N/D	18-5436	18-5342	18-5306	-
MB20C	0231178005		18-5356	18-5428	N/D	N/D	18-5436	-	18-5305	-
230A	TODOS	18-8813-1	18-5358	18-5428	N/D	N/D	18-5436	18-5349	18-5305	18-5265
230B	TODOS	18-8813-1	18-5358	18-5428	N/D	N/D	18-5436	18-5349	18-5305	18-5265
250A	TODOS	18-8813-1	18-5358	18-5428	N/D	N/D	18-5436	18-5349	18-5305	18-5265
250B	TODOS	18-8813-1	18-5358	18-5428	N/D	N/D	18-5436	18-5349	18-5305	18-5265
251A	TODOS		-	-	N/D	N/D	-	N/D	N/D	N/D

APLICACIONES CONTINUÁN EN LA SIGUIENTE PÁGINA

APLICACIÓN ENCENDIDO VOLVO PENTA (Cont.)

Modelo	Distribuidor	Kit cable bujías	Tapa distrib.	Rotor	bobina picado	ICM	Bobina encendido	Condensador	Puntos de contacto	Kit encendido
430A	TODOS		18-5353	18-5403	-	N/D	-	N/D	N/D	N/D
430B	TODOS		18-5353	18-5403	-	N/D	-	N/D	N/D	N/D
431A	TODOS		18-5353	18-5403	-	N/D	-	N/D	N/D	N/D
431B	TODOS		18-5353	18-5403	-	N/D	-	N/D	N/D	N/D
432A	DELCO EST	18-8835-1	18-5362	18-5408	18-5108	18-5107-1	-	N/D	N/D	18-5278
434A	DELCO EST	18-8835-1	18-5362	18-5408	18-5108	18-5107-1	-	N/D	N/D	18-5278
500A	TODOS		18-5352	18-5403	-	N/D	-	N/D	N/D	N/D
500B	TODOS		18-5352	18-5403	-	N/D	-	N/D	N/D	N/D
501A	TODOS		18-5352	18-5403	-	N/D	-	N/D	N/D	N/D
501A/MS4	TODOS		18-5352	18-5403	-	N/D	-	N/D	N/D	N/D
501B	TODOS		18-5352	18-5403	-	N/D	-	N/D	N/D	N/D
570A	TODOS		18-5352	18-5403	-	N/D	-	N/D	N/D	N/D
571A	TODOS		18-5352	18-5403	-	N/D	-	N/D	N/D	N/D
572A	TODOS		18-5352	18-5403	-	N/D	-	N/D	N/D	N/D
740A	TODOS		18-5352	18-5403	-	N/D	-	N/D	N/D	N/D
740A/MS5	TODOS		18-5352	18-5403	-	N/D	-	N/D	N/D	N/D
740B	TODOS		18-5352	18-5403	-	N/D	-	N/D	N/D	N/D
3.0GL	DELCO EST	18-8841-1	18-5361	18-5406	18-5108	18-5107-1	18-5443	N/D	N/D	18-5280
3.0GS	DELCO EST	18-8841-1	18-5361	18-5406	18-5108	18-5107-1	18-5443	N/D	N/D	18-5280
3.0GX	DELCO EST	18-8841-1	18-5361	18-5406	18-5108	18-5117	18-5465	N/D	N/D	18-5280
4.3Gi	DELCO HVS	18-8829-1	18-5243	18-5245	18-7642	18-5117	18-5467	N/D	N/D	18-5246
4.3Gi	DELCO EST	18-8835-1	18-5362	18-5408	18-5108	18-5107-1	18-7648	N/D	N/D	18-5278
4.3GL	DELCO EST	18-8835-1	18-5362	18-5408	18-5108	18-5107-1	18-7648	N/D	N/D	18-5278
4.3GS	DELCO EST	18-8835-1	18-5362	18-5408	18-5108	18-5107-1	18-7648	N/D	N/D	18-5278
4.3GX	DELCO EST	18-8835-1	18-5362	18-5408	18-5108	18-5107-1	18-7648	N/D	N/D	18-5278
4.3GX	DELCO HVS	18-8829-1	18-5243	18-5245	18-7642	18-5117	18-5467	N/D	N/D	18-5246
4.3Si	DELCO HVS	18-8829-1	18-5243	18-5245	18-7642	18-5117	18-5467	N/D	N/D	18-5246
5.0Fi	FORD	18-8820-1	18-5248	18-5413	-	N/D	18-7492	N/D	N/D	N/D
5.0FL	PRESTOLITE	18-8802-1	18-5352	18-5403	-	N/D	18-5437	N/D	N/D	N/D
5.0GIC	DELCO HVS	18-8828-1	18-5244	18-5245	18-7642	18-5117	18-5467	N/D	N/D	18-5247
5.0GI	DELCO EST	18-8836-1	18-5354	18-5405	18-5108	18-5107-1	18-7648	N/D	N/D	18-5281
5.0GL	PRESTOLITE	18-8802-1	18-5352	18-5403	-	N/D	18-5437	N/D	N/D	N/D
5.0GL	DELCO EST	18-8836-1	18-5354	18-5405	18-5108	18-5107-1	18-5443	N/D	N/D	18-5281
5.0GX	DELCO EST	18-8836-1	18-5354	18-5405	18-5108	18-5107-1	18-7648	N/D	N/D	18-5281
5.0GX	DELCO HVS	18-8828-1	18-5244	18-5245	18-7642	18-5117	18-5467	N/D	N/D	18-5247
5.0GXIE	DELCO HVS	18-8828-1	18-5244	18-5245	18-7642	18-5117	18-5467	N/D	N/D	18-5247
5.0OSIE	DELCO HVS	18-8828-1	18-5244	18-5245	18-7642	18-5117	18-5467	N/D	N/D	18-5247
5.0OSi	DELCO HVS	18-8828-1	18-5244	18-5245	18-7642	18-5117	18-5467	N/D	N/D	18-5247
5.7Gi	DELCO EST	18-8836-1	18-5354	18-5405	18-5108	18-5107-1	18-7648	N/D	N/D	18-5281
5.7GIC	DELCO HVS	18-8828-1	18-5244	18-5245	18-7642	18-5117	18-5467	N/D	N/D	18-5247
5.7GICE	DELCO HVS	18-8828-1	18-5244	18-5245	18-7642	18-5117	18-5467	N/D	N/D	18-5247
5.7GIE	DELCO HVS	18-8828-1	18-5244	18-5245	18-7642	18-5117	18-5467	N/D	N/D	18-5247
5.7Gi	DELCO HVS	18-8828-1	18-5244	18-5245	18-7642	18-5117	18-5467	N/D	N/D	18-5247
5.7Gi	DELCO EST	18-8836-1	18-5354	18-5405	18-5108	18-5107-1	18-5443	N/D	N/D	18-5281
5.7GL	MALLORY	18-8802-1	18-5352	18-5403	-	-	-	N/D	N/D	N/D
5.7GL	DELCO EST	18-8836-1	18-5354	18-5405	18-5108	18-5107-1	18-5443	N/D	N/D	18-5281
5.7GL	PRESTOLITE	18-8802-1	18-5352	18-5403	-	N/D	18-5437	N/D	N/D	N/D
5.7GSi	DELCO EST	18-8836-1	18-5354	18-5405	18-5108	18-5107-1	18-5443	N/D	N/D	18-5281
5.7GSii	DELCO EST	18-8836-1	18-5354	18-5405	18-5108	18-5107-1	18-5443	N/D	N/D	18-5281
5.7GSP	PRESTOLITE	18-8802-1	18-5352	18-5403	-	N/D	18-5437	N/D	N/D	N/D
5.7GX	DELCO EST	18-8836-1	18-5354	18-5405	18-5108	18-5107-1	18-7648	N/D	N/D	18-5281
5.7GXICE	DELCO HVS	18-8828-1	18-5244	18-5245	18-7642	18-5117	18-5467	N/D	N/D	18-5247
5.7GXIC	DELCO HVS	18-8828-1	18-5244	18-5245	18-7642	18-5117	18-5467	N/D	N/D	18-5247
5.7GXIE	DELCO HVS	18-8828-1	18-5244	18-5245	18-7642	18-5117	18-5467	N/D	N/D	18-5247

APLICACIÓN CONTINUAN EN LA SIGUIENTE PÁGINA

APLICACIÓN ENCENDIDO VOLVO PENTA (Cont.)

Modelo	Distribuidor	Kit cable bujías	Tapa distrib.	Rotor	bobina picado	ICM	Bobina encendido	Condensador	Puntos de contacto	Kit encendido
5.7GXl	DELCO HVS	18-8828-1	18-5244	18-5245	18-7642	18-5117	18-5467	N/D	N/D	18-5247
5.7GXii	DELCO HVS	18-8828-1	18-5244	18-5245	18-7642	18-5117	18-5467	N/D	N/D	18-5247
5.7GXii	DELCO EST	18-8836-1	18-5354	18-5405	18-5108	18-5107-1	18-5443	N/D	N/D	18-5281
5.70Si	DELCO HVS	18-8828-1	18-5244	18-5245	18-7642	18-5117	18-5467	N/D	N/D	18-5247
5.70SXl	DELCO HVS	18-8828-1	18-5244	18-5245	18-7642	18-5117	18-5467	N/D	N/D	18-5247
5.8Fi	FORD	18-8820-1	18-5248	18-5413	-	N/D	18-7492	N/D	N/D	N/D
5.8FL	PRESTOLITE	18-8803-1	18-5352	18-5403	-	N/D	18-5437	N/D	N/D	N/D
5.8FSi	PRESTOLITE	18-8803-1	18-5352	18-5403	-	N/D	18-5437	N/D	N/D	N/D
7.4Gi	DELCO EST	18-8836-1	18-5354	18-5405	18-5108	18-5107-1	18-5443	N/D	N/D	18-5281
7.4GL	PRESTOLITE	18-8802-1	18-5352	18-5403	-	N/D	18-5437	N/D	N/D	N/D
7.4GL	DELCO EST	18-8836-1	18-5354	18-5405	18-5108	18-5107-1	18-5443	N/D	N/D	18-5281
7.4GSi	DELCO EST	18-8836-1	18-5354	18-5405	18-5108	18-5107-1	18-5443	N/D	N/D	18-5281
8.1Gi	DELCO	18-8838-1	N/D	N/D	N/D	N/D	18-7493	N/D	N/D	N/D
8.1Gi-A	DELCO	18-8838-1	N/D	N/D	N/D	N/D	18-7648	N/D	N/D	N/D
8.1Gi-B	DELCO	18-8838-1	N/D	N/D	N/D	N/D	18-7648	N/D	N/D	N/D
8.1Gi-BF	DELCO	18-8838-1	N/D	N/D	N/D	N/D	18-7648	N/D	N/D	N/D
8.1Gi-C	DELCO	18-8838-1	N/D	N/D	N/D	N/D	18-7493	N/D	N/D	N/D
8.1GiC-400	DELCO	18-8838-1	N/D	N/D	N/D	N/D	18-7493	N/D	N/D	N/D
8.1GiCE	DELCO	18-8838-1	N/D	N/D	N/D	N/D	18-7493	N/D	N/D	N/D
8.1GiE	DELCO	18-8838-1	N/D	N/D	N/D	N/D	18-7493	N/D	N/D	N/D
8.1Gii-A	DELCO	18-8838-1	N/D	N/D	N/D	N/D	18-7648	N/D	N/D	N/D
8.1Gii-B	DELCO	18-8838-1	N/D	N/D	N/D	N/D	18-7648	N/D	N/D	N/D
8.1Gii	DELCO	18-8838-1	N/D	N/D	N/D	N/D	18-7493	N/D	N/D	N/D
8.1GSI-A	DELCO	18-8838-1	N/D	N/D	N/D	N/D	18-7648	N/D	N/D	N/D
8.1GXl	DELCO	18-8838-1	N/D	N/D	N/D	N/D	18-7493	N/D	N/D	N/D
8.1GXii	DELCO	18-8838-1	N/D	N/D	N/D	N/D	18-7493	N/D	N/D	N/D
8.1GXl-A	DELCO	18-8838-1	N/D	N/D	N/D	N/D	18-7648	N/D	N/D	N/D
8.1GXl-AF	DELCO	18-8838-1	N/D	N/D	N/D	N/D	18-7648	N/D	N/D	N/D
8.1GXii-A	DELCO	18-8838-1	N/D	N/D	N/D	N/D	18-7648	N/D	N/D	N/D
8.1IPS	DELCO	18-8838-1	N/D	N/D	N/D	N/D	18-7493	N/D	N/D	N/D
8.10Si	DELCO	18-8838-1	N/D	N/D	N/D	N/D	18-7493	N/D	N/D	N/D
8.2GL	PRESTOLITE	18-8803-1	18-5352	18-5403	-	N/D	18-5437	N/D	N/D	N/D
8.2GSi	DELCO EST	18-8836-1	18-5354	18-5405	18-5108	18-5107-1	18-5443	N/D	N/D	18-5281
DPX375	DELCO	18-8838-1	N/D	N/D	N/D	N/D	18-7648	N/D	N/D	N/D
DPX375-CF	DELCO	18-8838-1	N/D	N/D	N/D	N/D	18-7493	N/D	N/D	N/D
DPX385	DELCO EST	18-8836-1	18-5354	18-5405	18-5108	18-5107-1	18-5443	N/D	N/D	18-5281
DPX415	DELCO EST	18-8836-1	18-5354	18-5405	18-5108	18-5107-1	18-5443	N/D	N/D	18-5281
DPX420	DELCO	18-8838-1	N/D	N/D	N/D	N/D	18-7648	N/D	N/D	N/D
DPX420-CF	DELCO	18-8838-1	N/D	N/D	N/D	N/D	18-7493	N/D	N/D	N/D
V6-200	DELCO HVS	18-8829-1	18-5243	18-5245	18-7642	18-5117	18-5467	N/D	N/D	18-5246
V6-225	DELCO HVS	18-8829-1	18-5243	18-5245	18-7642	18-5117	18-5467	N/D	N/D	18-5246
V8-225	DELCO HVS	18-8828-1	18-5244	18-5245	18-7642	18-5117	18-5467	N/D	N/D	18-5247
V8-270	DELCO HVS	18-8828-1	18-5244	18-5245	18-7642	18-5117	18-5467	N/D	N/D	18-5247
V8-300	DELCO HVS	18-8828-1	18-5244	18-5245	18-7642	18-5117	18-5467	N/D	N/D	18-5247
V8-320	DELCO HVS	18-8828-1	18-5244	18-5245	18-7642	18-5117	18-5467	N/A	N/A	18-5247
V8-350	N/D	18-8838-1	N/D	N/D	N/D	N/D	-	N/D	N/D	N/D
V8-380	N/A	18-8838-1	N/A	N/A	N/A	N/A	-	N/A	N/A	N/A
V8-430	N/A	18-8838-1	N/A	N/A	N/A	N/A	-	N/A	N/A	N/A

APLICACIONES CONINÚAN EN LA SIGUIENTE PÁGINA

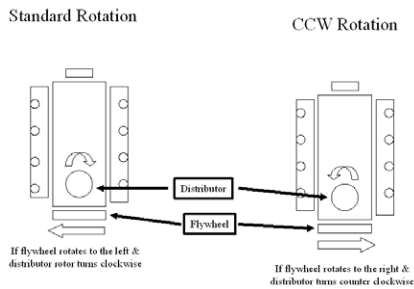

18-5923
MOTOR ARRANQUE
PMGR, Ford



18-5927
MOTOR ARRANQUE
PMGR, Ford



18-5911
MOTOR DE ARRANQUE
(Heavy-Duty) rotación como las agujas del reloj
Para motores GM, montaje inferior, tornillos paralelos y rotación standard.
Reemplaza: 834893, 855326
Reemplaza solenoide: 18-5837
SAEJ1171



18-5903
MOTOR ARRANQUE
Reemplaza: 841066-4
Rotación como las agujas del reloj
Montaje inferior, dos tornillos, motores
FORD rotación standard.
Reemplaza solenoide: 18-5801



18-5906
MOTOR DE ARRANQUE MANUFACTURADO
Reemplaza: 840808, 872241
• Intraborda
• Arranque reducción de marcha
• Magnético permanente, 12 Volt
• Rotación standard
• Piñón alojamiento aluminio con 2 roscas en agujero de montaje
Para : Motores Volvo Penta 4 Cilindro y 6 Cilindro Gas



18-5913
MOTOR DE ARRANQUE
Reemplaza: 3856004, 3860764, 3587625, 3853982, 3854751, 3885317 (sentido reloj)
2 tornillos 12V - 11 dientes tornillos desplazados
Para: Último modelo GM 14" volante
Reemplaza solenoide: 18-6287
SAEJ1171
1.7 KW



18-5919
MOTOR ARRANQUE
Reemplaza: 3856003
Permanente magnético I/O arranque
Para: Motores Chevy con 12 3/4" volante tornillos paralelos
Reemplaza solenoide: 18-6287
SAEJ1171
Para: 3.0 GS
1.7 KW



18-5920
MOTOR ARRANQUE
Reemplaza: 3854190
Sentido agujas del reloj/Rotación standard
Arranque magnético permanente
Reemplaza solenoide: 18-6291
Para: Motores 5.0 & 5.8 litros Ford



18-6275
MOTOR ARRANQUE
Reemplaza: 3857747, 3860566
• Intraborda
• Reducción magnética permanente
• 2 tornillos largos
• Rotación sentido agujas del reloj
• Usar con último Modelo 3.0L motores con 14" volante
Reemplaza solenoide: 18-5811
Para : Volvo Penta, Mercruiser, Marine Power



18-6834
MOTOR ARRANQUE
Reemplaza: Motores GM Universal
Usar con todos motores GM con volante 14 1/4" o 12 3/4"



18-6835
MOTOR ARRANQUE
Reemplaza: Motores GM Universal
Usado en motores GM con volante de 14 1/4" o 12 3/4"



18-6839
MOTOR ARRANQUE
Reemplaza: 1357199, -7, 3523301, -4, 5003564, -1
Para: 240,740,760,780,940 series 2.3L



18-6872
MOTOR DE ARRANQUE
(12 Volt)
Reemplaza: 233991, 240501, 837924, 842775, 843511, 847306-8, 881681
Para: 12V; Modelos TAMD, MD, AQD



18-6956
MOTOR DE ARRANQUE
Reemplaza: 3803227, -2, 834625-6, 841378-3, 841380, 841762, 63, 65, 66,



18-6958
MOTOR DE ARRANQUE
(24 Volt)
Reemplaza: 847308-4, 870998, 881682
Para: Modelos 24V; MD, TMD, TAMD



18-59710
ALTERNADOR
Reemplaza: 820652, 822454, 827303, 847651, 849561, 849602
Para: 24V; AQ Series gas y diesel
24V sistema



18-5882
ALTERNADOR
Reemplaza: 3884950
75A, 12V, Serpentin
3.0L, 4.3L, 5.0L, 5.7L, 8.1L (2007 - Actual)



18-5957
ALTERNADOR
Reemplaza: 3860769
(3-cable) (68 AMP)
Reemplaza Mando, Motorola y Original Equipamiento Delco.
Usa mismas conexiones eléctricas y método de montaje.
Equipado con ventilador y polea.
SAEJ1171



18-59700
ALTERNADOR
Reemplaza: 3803227, -2, 834625-6, 841378-3, 841380, 841762, 63, 65, 66,



18-5979
ALTERNADOR
Reemplaza: 3860082, Mando AC165622, Lester 12391
65 amp, 3.0GSM-A/B/C, 3.0GSP-A/B/C, 3.0GLM-A/B, 3.0GLP-A/B, 4.3GX1-A/B/BF/C.CF.D.DF, 4.3OSI-B/BF/C/CF/D/DF, 5.0GX1-A



18-6261
ALTERNADOR
Reemplaza: 3856600-6, 3857561
Mando para último Modelo Volvo Penta, 12 Volt, 65 Amp, Regulador interno, Single Polea estrias



18-5959
ALTERNADOR
Reemplaza: 826495, 834609, 834963, 841762, 841765, 841766.
Valeo A13N1M, 2M, 147M, 148M
14V/50 AMP: AQ120-AQ145, AQ200D-AD290-TMD40-MD21-8070-MD5C, MD18-7D-MD30-TMD30-TAM30, MD18-MD2B-MD2BHY-MD3B-MD21A, MD32A-AQD32A/270D (Mot V8S), MD5-MD7-MD11-MD17-B21-B22 Mot. TMD40), Series 2002-2003-R,V,S.



18-5939
ALTERNADOR
 Reemplaza: 872235, 3803260, 873770
 Valeo: A13N234, 2541451
 14V/60 AMP: AQ115, AQ120B, AQ125, AQ130, AQ140, AQ145, AQ165, AQ170, AQ200, AQ225, AQ256, AQ260, AQ280, AQ290, BB115, BB145, MB20; Aplicación motor: AQD2B, AQD21A, AQD21B, AQD27, AQD29, AQD32A, MD11C, MD11D, MD17C, MD17D, MD2B, MD2010A, MD2010B, MD2030A, MD2030B, MD2040A, MD2040B, MD21A, MD21B, MD27, MD29, MD3B, MD32A, MD6A, MD6B, MD7, TAM71A, TAM71B, TAM72A, TAMD7WI-A.



18-5943
ALTERNADOR
 Reemplaza: 872926, 3803227
 Valeo: A13N259, 541663
 14V/50 AMP: 431, 500, 501, 570, 740DP, 740/MSS, AQ131, AQ145B, AQ175, AQ200, AQ205, AQ211, AQ225, AQ260, AQ271, AQ290, AQ311, BB165, BB170, BB225, BB231, BB260, BB261; Aplicación motor: 2001, 2002, 2003, 2003T, AD31A, AQAD30A, AQAD31A, AQAD40A, AQAD41, AQAD41A, AQD40A, AQD41, AQD41A, KAD42A, KAMD42A, MD30A, MS31A, MD40A, MD7B, TAMD40A, TAMD41A, TAMD41B, TAMD41D, TAMD70E, TMD30A, TMD31A, TMD40A, TMD41A.



18-6845
ALTERNADOR
 Reemplaza: 3862613, 3862665, 3884950
 Para: Motores 3.0GLM, 3.0GLP



18-6846
ALTERNADOR
 Reemplaza: Volvo Penta 1502272, 3803270-2, 5001677, 845940, 72021, 872022, 872757, 873635, 873757, 873757-9, 873771,



18-6847
ALTERNADOR
 Reemplaza: 3862613, 2655301,
 Para: 2000-07 3.0GLP, GSP, GSM, 4.3GXi, 5.0GXi, Si, 5.7Gi, GXi, Osi, Sxi



18-6975
ALTERNADOR (Universal)
 Para: Alternador 160A, montaje universal basado en Delco CS1300, correa y serpiente de 6 estrías i polea incluida.



18-6848
ALTERNADOR
 Reemplaza: Volvo 3862612, 2656299, Valeo A0002655299
 Para: 2000 y on Volvo Penta Models con 4.3, 5.0, and 5.7 GM engines



18-6953
ALTERNADOR
 Reemplaza: Volvo
 Para: Modelos Diesel D3



18-6955
ALTERNADOR
 Reemplaza: Caterpillar 3001117, 10-258, Prestolite 110-258, 110-258A, Volvo 849748-9
 Para: Modelo cilindro Volvo Diesel 8

APLICACIÓN ALTERNADOR/ARRANQUE

MOTORES GASOLINA

Modelo	Motor	Año	Arranque	Alternador	Modelo	Motor	Año	Arranque	Alternador
AQ115			18-5918	N/D	AQ145			18-5918	18-5959
AQ120B			18-5918 ①	N/D	AQ145A	4 cil	1979-1985	18-5918 ③	18-5959
AQ120B			18-5906	N/D	AQ145A	4 cil	1979-1985	18-5906 ⑤	18-5959
AQ125A			18-5918 ①	18-5959	AQ145B	4 cil	1979-1985	18-5906 ⑤	18-5959
AQ125A	4 cil	1981-1985	18-5906 ②	18-5959	AQ151A	4 cil	1985-1989	18-5906	18-5959
AQ125B	4 cil	1981-1985	18-5906 ②	18-5959	AQ151B	4 cil	1985-1989	18-5906	18-5959
AQ130			18-5918	N/D	AQ151C	4 cil	1985-1989	18-5906	18-5959
AQ131A	4 cil	1985-1989	18-5906	18-5959	AQ165			18-5918	N/D
AQ131B	4 cil	1985-1989	18-5906	18-5959	AQ170			18-5918	N/D
AQ131C	4 cil	1985-1989	18-5906	18-5959	AQ171A	4 cil	1986-1994	18-5906	18-5959 ⑥
AQ131D	4 cil	1985-1989	18-5906	18-5959	AQ171C	4 cil	1986-1994	18-5906	18-5959 ⑥
AQ140A			18-5918 ③	18-5959	AQ175A			18-5911 ⑤	N/D
AQ140A			18-5906 ②	18-5959	AQ190A			18-5903	N/D

① Anterior SN 7679/013489 ② AQ125A desde S/N 7679/013489 ③ Anterior SN 7705/001557 ⑤ AQ145A & BB145A desde SN 7705/001557
 ⑥ 18-5959 14V/50AMP ⑦ Montaje de las roscas de los tornillos en el soporte ⑧ 18-5939 14V 50 AMP

Modelo	Motor	Año	Arranque	Alternador	Modelo	Motor	Año	Arranque	Alternador
AQ200B			18-5911	18-5959	BB145			18-5918	N/D
AQ200C			18-5911	18-5959	BB145A	4 cil	1979-1985	18-5918 ③	18-5959
AQ200D			18-5911	18-5959	BB145A			18-5906 ⑤	N/D
AQ200F			18-5911	18-5959	BB165			18-5918	N/D
AQ205A			18-5911	N/D	BB170			18-5918	N/D
AQ211A			18-5911	N/D	BB225A			18-5911	18-5959
AQ225A			18-5911	18-5959	BB225B			18-5911	18-5959
AQ225B			18-5911	18-5959	BB225C			18-5911	18-5959
AQ225C			18-5911	18-5959	BB260A			18-5911	18-5959
AQ225D			18-5911	18-5959	BB260B			18-5911	18-5959
AQ225E			18-5911	18-5959	BB260C			18-5911	18-5959
AQ225F			18-5911	18-5959	230			18-5906	18-5943
AQ231A			18-5911	N/D	250			18-5906	18-5943 ⑦ 18-5939 ⑧
AQ231B			18-5911	N/D	251A			18-5906	N/D
AQ240A			18-5903	N/D	430			18-5911	18-5943 ⑦
AQ255A			18-5911	N/D	431			18-5911	18-5943 ⑦
AQ255B			18-5911	N/D	432			18-5911	18-5943 ⑦
AQ260A			18-5911	18-5959	434			N/A	N/D ⑦ 18-5939 ⑧
AQ260B			18-5911	18-5959	500-570			18-5911	18-5943 ⑦ 18-5939 ⑧
AQ271A			18-5911	N/D	571A			18-5911	N/D N/D
AQ271B			18-5911	N/D	572			18-5911	18-5943 18-5939 ⑧
AQ271C			18-5911	N/D	740B			18-5911	18-5943 18-5939 ⑧
AQ271D			18-5911	N/D	3.0L			18-5919	N/D
AQ280			18-5911	N/D	4.3L			18-5913	N/D
AQ290A			18-5911	18-5959	5.0L (GM)	V-8	1994-2007	18-5913	N/D
AQ311A			18-5911	N/D	5.7L (GM)	V-8	1994-2007	18-5913	N/D
AQ311B			18-5911	N/D	7.4L (GM)	V-8	1994-2007	18-5913	N/D
BB115			18-5918	N/D	8.2L (GM)	V-8	1994-2007	18-5913	N/D
BB140A			18-5918 ③	18-5959	5.0L (FORD)	V-8	1994	18-5920	N/D
BB140A			18-5906	N/D	5.8L (FORD)	V-8	1994	18-5920	N/D

① Inf SN 7679/013489

② AQ125A a partir de S/N 7679/013489

③ Inf SN 7705/001557

⑤ AQ145A & BB145A a partir de SN 7705/001557

⑥ 18-5959 14V/50AMP

⑦ Tornillos montaje en el soporte

⑧ 18-5939 14V 50 AMP



18-6291

SOLENOIDE

Reemplaza: 3854194-2, OMC 3854194
Para: Ford motor de arranque último
Último modelo 5.0L, 5.8L,
OMC y Volvo Penta



18-5806

SOLENOIDE ARRANQUE

Reemplaza: 834520
BOSCH 0331-302-050, 0331-302-081,
0331-302-085, 0331-302-581, 0331-302-585
Para motores con tapa de aluminio.
Terminal eje solenoide 13/32" de largo.



18-5811

SOLENOIDE ARRANQUE

Reemplaza: 3850216, 3859054
Para: Serie arranque PG 260, GM V6 & V8 (1983-Sup)



18-5837

SOLENOIDE

Reemplaza: 3853869, 3853998
Para: 3.0 ; GL, GS, 4.3L GL, GS, 5.7L GL, GI,
7.4L GL, 8.2L GL



18-9802

LUZ PUESTA APUNTO

Hasta de 10,000 RPM's



18-69550

DISYUNTOR

Reemplaza: 3854164
Para: Aplicaciones motores gasolinaVolvo Multiple



18-6271
RELÉ
Reemplaza: 870670, 6643474, 876038, 241812
12 Volt, 30 Amp



18-6268
RELÉ
Reemplaza: 841177, 872272
12 Volt, 30 Amp



18-6266
RELÉ
Reemplaza: 876040, 872300
12 Volt, 30 Amp/20 Amp

① **18-5705D**



18-5705
RELÉ POWER TRIM
Reemplaza: 876039
5 Terminal
Para: AQ 175, 200, 225D, 260, 290A

18-5700
RELÉ TRIM



Reemplaza:
3858081, 3858809
Para: (1998 SX-M-MAC, MDA, MLT), 3.0GLP-D, 4.3GL-E, 4.3GL-EF, 4.3GXl-F, 4.3GXl-FF, 4.3OSi-F, 4.3OSi-FF, 5.0GL-F, 5.0GL-FF, 5.0GXl-F, 5.0GXl-FF, 5.0Si-F, 5.0Si-FF, 5.7Gi-F/FF, 5.7GXl-G/GF, 5.7OSi-E/EF, 5.7OXl-E/EF, 5.7GIl-F, 5.7GXl-G, 8.1Gi-G/GF, 8.1GXl-F/FF, 8.1OSi-C/CF, 8.1GIl-G, 8.1GXl-F, DPH-A, DPH-B, DPR-A, DPH-B, EF drives, SX-M TSKs 1998-05, SX-M, DP-SM, (WT drives, PJX-C, PJX-S SX-M, -MACLT, -MDA, -MDB, -MHP, -MTD, DP-E, DP-S, -S1, -S2, DP-SM, -SM)XDP-B



18-5704
RELÉ POWER TRIM
Reemplaza: 876037
20 Amps Resis.
15 Amps Induct.
Tiro único 5 Terminal
Para: AQ270, 280

PACK. DE 5



18-6951
18-6951-9②
FUSIBLE POWER TILT (30 Amp)
Reemplaza: 851120

18-6770
BOMBA TILT/TRIM
Reemplaza: 854346
Oildyne



Para: Transmisión Version SX con 2.5" tornillos centrales y finas roscas
Motor 18-6817

18-6806
BOMBA TRIM
Reemplaza: 3587079, 3857489, 3860879
Para: SX - Último Modelo con rosca gruesa
Motor 18-6804



18-6822
BOMBA TRIM
Reemplaza: Volvo Penta 852928, 820545, OMC 172543, 382715
Motor 18-6838

18-6804
MOTOR TRIM



Reemplaza: 3861575
Para: transmisiones SX - Última Versión / 2.3" tornillos centrales con rosca gruesa

18-6817
MOTOR TRIM
Reemplaza: 854525-3, 3858071

Para: Último modelo Volvo Penta
Para: SX - primera Version / rosca fina & 2.5" tornillos centrales



18-6838
TRIM MOTOR
Reemplaza: 3586765, 852928, 872449, 873051
Para: transmisiones DP, DPX
Reemplaza Bomba 18-6822



18-6881
MOTOR CON BOMBA TRIM
Reemplaza: Volvo 852928, 872449, 873051,
Para: Transmisiones DP, DPX
Motor 18-6838
Bomba 18-6822



18-6823
CABLEADO
Reemplaza: Universal
Convierte 3-cables Tilt y Trim a 2-cables

① Referencias acabadas en "D" envasadas - Referencia normal no envasada

② Precio por pack

18-6274

MOTOR TILT/TRIM

Reemplaza: 852928, 3857265
 Reemplaza : Prestolite HYK4001
 Incluye cuerpo válvula hidráulica



18-6758

MOTOR TILT/TRIM

Reemplaza: 850834
 Electrolux KP5024/120



18-6779

MOTOR TRIM

Reemplaza: 986280, 3853945
 Para: PJX, SX, DPS, DP, DPX, 3.0L GS,
 GL, 4.3L GL, GS, GI, 5.0L FL, FI, 5.7L
 GL, GI, 5.8L FL, FI, FSI



18-6790

MOTOR TILT

Reemplaza: 839430,
 Electrolux KS3448/290
 Para: Modelos antiguos Volvo



18-6791

MOTOR TILT

Reemplaza: 850046, 853520
 Para: Modelos antiguos Volvo



18-6792

MOTOR TILT

Reemplaza: 897720, 854329
 Para: Modelos antiguos Volvo



18-7641

CARBURADOR

(Remanufacturado)

Reemplaza: 841047-4, 841313-0, 3856393
 AQ225B,C,D,E,F; 225A,B; AQ260A,B; 290A; BB225A,AV,
 BB225B,C; 260A,AV,B,C; 501A, 501A/MS4A; 570/MS4A
 Usar kit recambio 18-7095



18-79993

CARBURADOR

(Remanufacturado)

Para: Solex 44 PAI for AQ115-170



18-79998

CARBURADOR

(Remanufacturado)

Reemplaza: R80316
 Para: 3.0L GL, GS



18-80005

CARBURADOR

(Remanufacturado)

Reemplaza: 17059059
 Para: AQ175, 200, 225, 290



18-80006

CARBURADOR

(Remanufacturado)

Reemplaza: R80382
 Para: 5.0, 5.8L, Fi, FL, SX con 2bbl Holley



18-80007

CARBURADOR

(Remanufacturado)

Reemplaza: R80383
 Para: 5.0, 5.8L, Fi, FL, SX con 4bbl Holley



18-80008

CARBURADOR

(Remanufacturado)

Reemplaza: R7044289
 Para: 7.4L con 4 bbl Rochester



18-80009

CARBURADOR

(Remanufacturado)

Reemplaza: R80378
 Para: 7.4L Gi, GL, Gsi & 8.2L GL





18-7000
KIT CARBURADOR
 Reemplaza: 841836-0, 841292
 SOLEX ESQUEMA INFERIOR
 (856471 + 856472 = 18-7000)



18-7001
KIT CARBURADOR
 Reemplaza: 841293-4
 SOLEX ESQUEMA LATERAL



18-7008
KIT CARBURADOR



18-7040
KIT CARBURADOR
 Contiene agujas y asientos



18-7072
KIT CARBURADOR
 Reemplaza: 855889



18-7085
KIT CARBURADOR
 Reemplaza: 875407



18-7086
KIT CARBURADOR
 Reemplaza: 841994



18-7095
KIT CARBURADOR
 Reemplaza: 834985-4



18-7237
KIT CARBURADOR

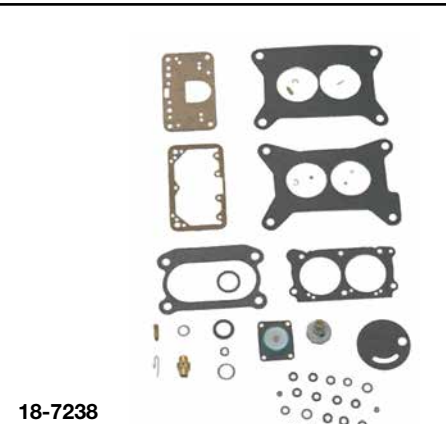

18-7238
KIT CARBURADOR
 Reemplaza: 3854020
 Para: 4.3L GL, GS, 5.0L GL, 5.7L GL

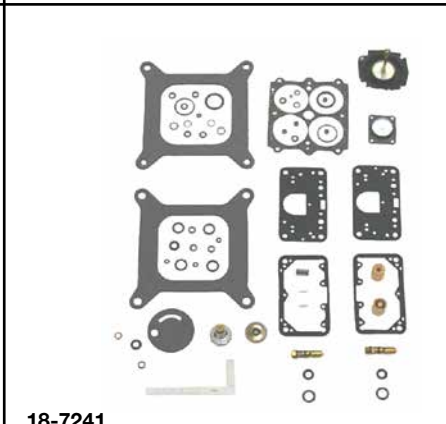

18-7241
KIT CARBURADOR
 Reemplaza: 3855017
 Para: 7.4L GL, 8.2L GL



18-7242
KIT CARBURADOR
 Reemplaza: 3854105

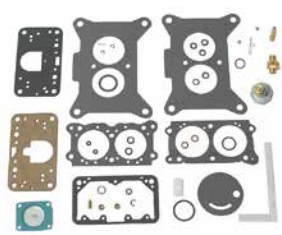

18-7244
KIT CARBURADOR
Reemplaza: 3854106



18-7245
KIT CARBURADOR
Reemplaza: 3854107



18-7246
KIT CARBURADOR
Reemplaza: 3854116
Para: 3.0L GLM, GLP, GSM, GSP, GS, GL

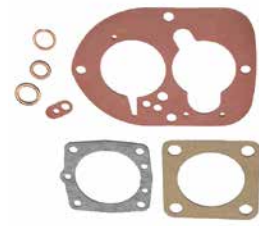

18-7099
KIT JUNTA CARBURADOR
Reemplaza: 824803, 856470



18-7200
FLOTADOR
Reemplaza: 841634-9
(RESISTENTE AL ALCOHOL)
Latón



18-7201
FLOTADOR
(RESISTENTE AL ALCOHOL)
Latón



18-7202
FLOTADOR
(RESISTENTE AL ALCOHOL)
Latón



18-36905
FLOTADOR
Reemplaza: 3854018
Para: 3.0L GLM, GLP con 2 bbl Holley Carb

KIT APLICACIÓN KIT CARBURADOR/FLOTADOR/JUNTA CARBURADOR

Modelo	Cil.	Mfg Cod	Carb Model	Carburador #	Kit Carb ①	Flotador	Kit junta carb
AQ115A,B,125A,B,130C,D, AQ131A,B,C,D,145A,B AQ151A,B,C,171A,C BB115B,C,145A	4	—	—	SOLEX 44 PA1	18-7000	—	18-7099
AQ120B,140A,BB140A	4	—	—	SOLEX 44 PHN-3	18-7001	—	—
AQ80	4	—	—	ZENITH 34VN	18-7008	—	—
AQ95,95A,100,105A,110, 115 W/109", (1780cc) Instalación Dual Carb.	4	ZS-1	150CD	150CD-SE (C1865F,R, C304D,F,R)	18-7085	—	—
AQ120, AQ130A,B,BB115A,w. 121" (1986cc) Instalación Dual Carb.	4	ZS-1	175CD	175CD-2S, (C3098F,R, C3200 F,R,C,3231 F,R)	18-7085	—	—
3.0L GL,GS	4	H-2	2300	R-80316A,R-80316-1A	18-7246	—	—
AQ170A,B,C,BB170A,B,C	6	—	—	SOLEX 44 PA1	18-7000	—	18-7099
AQ165A,BB165A (3 instalación Carb.)	6	ZS-1	175CD	175CD-2S, (C3201F,M, R,C 3232F,M,R)	18-7085	—	—
AQ175A	6	R-2	2GE	17059059	18-7086	18-7200	—
4.3L GL,GS	6	H-2	2300	R-80312A,R-80312-1A	18-7238	—	—
4.3L GL,GS	6	H-4	4160	R-80403A,R-80403-1A	18-7237	—	—
AQ200D,F and 500A	8	R-2	2GE	17057133, 17059059	18-7086	18-7200	—
AQ225B,C,D,E,F,255A,B, AQ260A,B,290A,BB225A,AV, BB225B,C,260A,AV,B,C	8	R-4	4ME	17059283,296, 298	18-7095	18-7201	—
501A,501A/MS4A,570/MS4A	8	R-4	4MC, 4MV	7044288,7044289, 1705,628717,057,290	18-7072	18-7201	—
305" (5.0L),307" (5.0L),350" (5.7),	8	R-4	4MC, 4MV	7044288,7044289, 1705,628717,057,290	18-7072	18-7201	—
5.0L, 5.8L (Fi, FL,SX) (Ford)	8	H-2	2300	R-80382A,R-80382-1A	18-7244	—	—
5.0L, 5.8L (Fi, FL) (Ford)	8	H-4	4150	R-80383A,R-80383-1A	18-7245	—	—
740A/MS5A	8	H-4	4011	R84026AA	18-7040	—	—
454" (7.4L)	8	R-4	4MC, 4MV	7044288,7044289, 1705,628717,057,290	18-7072	18-7201	—
7.4L GL	8	H-4	4150	R-80378A,R-80378-1A	18-7242	—	—
8.2L GL	8	H-4	4150	R-80378A,R-80378-1A	18-7242	—	—

① No incluye medidor

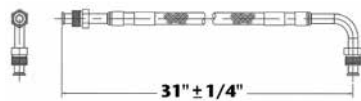

18-8114
LÍNEA DE COMBUSTIBLE

Conexión de la bomba de combustible al carburador.
Reemplaza tubo de 3/8" X 31" PTFE con terminales macho de 5/8"-18 y 5/8"-18 y 90°. SAE J1527 tipo A1



18-8115
LÍNEA DE COMBUSTIBLE

Conexión de la bomba de combustible al carburador.
Reemplaza tubo de 3/8" X 25" PTFE con terminales macho de 5/8"-18 y 5/8"-18 90°. SAE J1527 tipo A1



18-7326
BOMBA COMBUSTIBLE ELÉCTRICO
 Reemplaza: 3850809,
 3858261, 3854620, 3857986



18-7330
BOMBA COMBUSTIBLE ELÉCTRICO
 Reemplaza: 3857650, 3855958



18-7331
BOMBA COMBUSTIBLE ELÉCTRICO
 Reemplaza: 3850810,
 3857985, 3858714

APLICACIÓN BOMBA COMBUSTIBLE ELÉCTRICO

Año	Motor	Aplicación	OE #	#'s Ref.OEM antiguas	Ref #
1994-99	262/4.3L (HU-WT)	Bomba alta presión	3857650		18-7330
1994-99	262/4.3L GL/GS (All)	Carburador- Baja presión	3858261	3850809	18-7326
1994-99	262/4.3L GI (HU-WT)	W.Elec. bomba - Baja presión	3858261	3850809	18-7326
1994-99	454/7.4L & 502/8.2L (HU-WT)	Sistema baja presión	3858714	3850810, 3857985	18-7331
1993-99	350/5.7L, 454/7.4L, & 502/8.2L	Motores con MPI - Alta presión	3857650		18-7330
1996-99	454/7.4L & 502/8.2L (HU-WT)	Motores con MPI - Alta presión	3857650		18-7330
1994-99	5.0L hasta 5.8L	Bomba comb. eléctrica baja presión	3858261	3850809	18-7326
1994-99	454/7.4L & 502/8.2L (HU-WT)	Motores GM Mark V . - baja presión	3858714	3850810, 3857985	18-7331
1992-93	454/7.4L	Motores GM Mark V - baja presión	3858714	3850810, 3857985	18-7331



18-7268
BOMBA COMBUSTIBLE
 Reemplaza: 3855276
 Para: Motor 5.7L Litro
 Doble diafragma requiere la mirilla



18-7281
BOMBA COMBUSTIBLE
 Reemplaza: 826493
 Para: GM (V-8) 305, 350
 (Incluye junta)



18-7286
BOMBA COMBUSTIBLE
 Reemplaza: 841161
 Para: Bomba acero XP
 AQ120B (spec# 867465), AQ125A/B, AQ131A/B/C/D,
 AQ140A (spec# 867464), BB140A, AQ145A, BB145A,
 AQ151A/B/C, AQ171A/C, AQ230A/B, AQ250A/B, AQ251A



18-35442
BOMBA COMBUSTIBLE
 Reemplaza: 859428
 Para: Último motores Volvo 2000 Series



18-7229
ANTIDFLAGRANTE
 Reemplaza: 3854026
 Para: 3.0L GS, GL, 4.3L GL, GS, GSI, 5.0L
 FL, FI, 5.7L GL, GI, 5.8L FL, FI, FSI



- DISEÑO UNIVERSAL -

SOPORTES SEPARADOR COMBUSTIBLE/AGUA

Tipo soporte	Ref #	Tipo soporte	Ref #
1/4" acero inox	18-7777	1/4" Aluminio	18-7853-1
3/8" acero inox	18-7776	3/8" Aluminio	18-7775

KIT SEPARADOR COMBUSTIBLE/AGUA**KITS DE FILTROS DE 21 MICRONES PARA MOTORES DE CARBURACIÓN**

Kit Tipo	Ref #	Capacidad de filtrado	Contenido
1/4" Aluminio (Filtro corto)	18-7848-1	21	1 - 18-7844 filtro & 1 18-7853-1 soporte 2 - 18-4256 1/4" Tapones
1/4" Aluminio Bonus Pack Contiene filtro de repuesto	18-7848-2	21	2 - 18-7844 filtro & 1 18-7853-1 soporte 2 - 18-4256 1/4" Tapones
1/4" Aluminio (Filtro alto)	18-7852-1	21	1 - 18-7845 filtro & 1 18-7853-1 soporte 2 - 18-4256 1/4" Tapones
1/4" Aluminio Bonus Pack Contiene filtro separador	18-7852-2	21	2 - 18-7845 filtro & 1 18-7853-1 Soporte 2 - 18-4256 1/4" Tapones
3/8" Aluminio (Filtro alto)	18-7775-1	21	1 - 18-7845 filtro & 1 18-7775 Soporte 2 - 18-4264 3/8" Tapones
1/4" Acero inox (Filtro alto)	18-7777-1	21	1 - 18-7845 filtro & 1 18-7777 Soporte 2 - 18-4256 1/4" Tapones
3/8" Acero inox (Filtro alto)	18-7776-1	21	1 - 18-7845 filtro & 1 18-7776 Soporte 2 - 18-4264 3/8" Tapones

**KITS DE FILTROS DE 10 MICRONES PARA MOTORES DE INYECCIÓN**

Kit tipo	Ref #	Capacidad de filtrado	Contenido
1/4" Aluminio (Filtro corto)	18-7983-1	10	1 - 18-7944 filtro & 1 18-7853-1 soporte 2 - 18-4256 1/4" Tapones
1/4" Aluminio Bonus Pack Contiene filtro separador	18-7983-2	10	2 - 18-7944 filtro & 1 18-7853-1 soporte 2 - 18-4256 1/4" Tapones
1/4" Aluminio (Filtro alto)	18-7982-1	10	1 - 18-7945 filtro & 1 18-7853-1 soporte 2 - 18-4256 1/4" Tapones
1/4" Aluminio Bonus Pack Contiene filtro separador	18-7982-2	10	2 - 18-7945 filtro & 1 18-7853-1 soporte 2 - 18-4256 1/4" Tapones
1/4" Aluminio (Filtro alta capacidad)	18-7966-1	10	1 - 18-7866 filtro & 1 18-7853-1 soporte 2 - 18-4256 1/4" Tapones
3/8" Aluminio (Filtro alto)	18-7986-1	10	1 - 18-7945 filtro & 1 18-7775 soporte 2 - 18-4264 3/8" Tapones
1/4" Acero inox (Filtro alto)	18-7984-1	10	1 - 18-7945 filtro & 1 18-7777 Soporte 2 - 18-4256 1/4" Tapones
3/8" Acero inox (Filtro alto)	18-7985-1	10	1 - 18-7945 filtro & 1 18-7776 Soporte 2 - 18-4264 3/8" Tapones



KITS FILTROS 10 MICRONES CON VASO DECANTADOR

El vaso transparente Sierra AquaVue™ y la cazoleta metálica permiten drenar el agua, alargan la vida útil del filtro.
Use el vaso transparente AquaVue™ para instalaciones de fueraborda y en la cubierta.

Kit Tipo	Ref #	Capacidad de filtrado	Contenido
1/4" Aluminio con cazoleta metálica	18-7951	10	1 - 18-7919 filtro & 1 18-7853-1 soporte 1 - 18-7924 cazoleta metálica 2 - 18-4256 1/4" tapones
1/4" Acero inox con cazoleta metálica	18-7938	10	1 - 18-7919 filtro & 1 18-7777 soporte 1 - 18-7924 cazoleta metálica 2 - 18-4256 1/4" tapones

KITS SOPORTES Y SEPARADORES TIPO VOLVO

18-7778
SOPORTE DE ALUMINIO
SOPORTE DE RECAMBIO
Reemplaza: 3850861



KIT SEPARADOR Y SOPORTE- PARA APLICACIONES EN FUERABORDAS Y AGUA DULCE

18-7774
SOPORTE ALUMINIO



18-7965-1
KIT SEPARADOR COMPACTO
10 MICRON
Contiene:
1 - 18-7774 soporte
1 - 18-7865 filtro



FILTRO DE RECAMBIO



DISEÑO UNIVERSAL

FILTROS DE RECAMBIO 10 MICRONES			FILTROS DE RECAMBIO 21 MICRONES		
Ref #	Descripción	Reemplaza	Ref #	Descripción	Reemplaza
18-7944	corto - 3.875"		18-7844	corto - 3.875"	
18-7945	Largo - 4.35"		18-7845	Largo - 4.35"	
18-7866	Alta capacidad - 6"				
18-7865	Compacto 10 Micrones				
FILTROS DE RECAMBIO PARA VOLVO					
FILTRO RECAMBIO 10 MICRONES			FILTRO RECAMBIO 21 MICRONES		
18-7946	Rosca OMC		18-7846	Rosca OMC	
18-7989	Volvo SX/EFI Cobra EFI	Volvo 3851218-2, 3852413, 3862228	18-7789	Volvo SX/EFI Cobra EFI	Volvo 3851218-2, 3852413



RECAMBIOS DE FILTROS Y KITS CON CAZOLETA DE 10 MICRONES

FILTRO RECAMBIO			CAZOLETAS DE RECAMBIO	
Ref #	Descripción	Reemplaza	Ref #	Descripción
18-7919	Filtro	Racor S3213	18-7924	Cazoleta metálica
18-7920	Filtro	Racor S3214		
18-7947	Filtro Para - 120RRAC01	Racor S3240	FILTRO & CAZOLETA	
18-7948	Filtro Para - 320RRAC01	Racor S3227	Ref #	Descripción
18-7949	Filtro Para - 660RRAC02	Racor S3232	18-7929	Filtro & Cazoleta metálica Contiene: 18-7919 filtro, 18-7924 caz.

**18-8125
FILTRO COMBUSTIBLE DIESEL**

Reemplaza: 3583443
 D4-180i-B, D4-180i-C, D4-210A-A, D4-210A-B, D4-210i-A, D4-210i-B, D4-225A-B, D4-225A-C, D4-225i-B, D4-225i-C, D4-260A-A, D4-260A-B, D4-260A-C, D4-260D-B, D4-260D-C, D4-260i-A, D4-260i-B, D4-260i-C, D4-300A-A, D4-300A-C, D4-300D-A, D4-300D-C, D4-300i-A, D4-300i-C, D6-280A-A, D6-280A-B, D6-280i-A, D6-280i-B, D6-310A-A, D6-310A-B, D6-310D-A, D6-310D-B, D6-310i-A, D6-310i-B, D6-330A-B, D6-330A-C, D6-330D-B, D6-330D-C, D6-330i-B, D6-330i-C, D6-350A-A, D6-350A-B, D6-370A-B, D6-370A-C, D6-370D-A, D6-370D-B, D6-370D-C, D6-370i-A, D6-370i-B, D6-370i-C, D6-435D-A, D6-435D-C, D6-435i-A, D6-435i-C



**18-8126
FILTRO COMBUSTIBLE DIESEL**

Reemplaza: 861477
 D1-13 A, D1-13 B, D1-20 A, D1-20 B, D1-30 A, D1-30 B, D2-40 A, D2-40 B, D2-55 A, D2-55 B, D2-55 C, D2-55 D, D2-55 E, D2-55F, D2-75 A, D2-75 B, D2-75 C, D2-75F, MD2010A, MD2010B, MD2020A, MD2020B, MD2030A, MD2030B, MD2040A, MD2040B



**18-7858
FILTRO COMBUSTIBLE**

Reemplaza: 858201
 Para tipo CAV
 AQ120B, 125A, B, 131A, 140A, 145A,B, 151, BB, 140, 145A



**18-7862
ELEMENTO FILTRANTE COMBUSTIBLE**

Reemplaza: 841162
 (Incluye junta)



**18-8149
FILTRO SEPARADOR AGUA/COMB. DE ALTA CAPACIDAD**

Reemplaza Volvo 3847644
 Para mayoría de aplicaciones con bomba combeléctrica. (pueden darse problemas de altura cuando se use la ref 18-7778, Volvo 3850861)



**18-7942
FILTRO COMBUSTIBLE**

Reemplaza: 466987, 3825133
 Para: MD100A, TMD100A, MD100B, MD120A, TMD120A, TAMD120A, MD120B, TMD120B, TAMD120B, MD70B, TMD70B, TAMD70B, THAMD70B, AQAD70B, MD70C, TMD70C, TAMD70C, AQD70C, TAMD60A, TAMD60B, TAMD60C, D5/D7 MARINE GENSET, D5A-T, D5A-TA, D7A-T, D7A-TA, D7C-TA, D63 MARINE, D71/73 MARINE, KAD32P, TAMD42WJ, KAD43P/44P/300, KAMD43P/44P/300, TAMD103A, TAMD61A, TAMD62A, TAMD71A, TAMD72A, TAMD72P, TAMD72WJ, TAMD74, TAMD75 MARINE, TMD102A, TAMD102A, TAMD102D, TMD122A, TAMD122A, TAMD122P, TMD31L, TAMD31P/L/M/S, AD31P/L, TMD41L, TAMD41P/L/M/H



**18-7709
FILTRO COMBUSTIBLE**

Reemplaza: 3840335
 Para: KAD42P-A, KAMD42P-1, KAD44P-B, KAD44P-C, KAMD44P-A, KAMD44P-B, KAMD44P-C, TAMD42WJ-A, KAD43P-A, KAMD43P-A, KAT44P-C, KAD300-A, KAMD300-A, MD6A, MD6B, MD7A, MD7B, D41L-A, TAMD41H-B, TMD41L-A, AD41L-A, AD41P-A, TAMD41H-A, TAMD41P-A, MD22A, MD22A-A, MD22L-A, TMD22A, TMD22-A, D3-110i-A, D3-130A-A, D3-130i-A, D3-160A-A, D3-160i-A, D3-110i-B, D3-110i-C, D3-130A-B, D3-130i-B, D3-130A-C, D3-130i-C, D3-160A-B, D3-160i-B, D30160A-B, D3-160A-C, D3-160i-C, D3-190A-B, D3-190i-B, D3-190A-C, D3-190i-C, KKAD42A, KAMD42A, AD41D, D41D, TAMD41D, TMD41D, MD22L-B, MD22P-B, TMD22-B, TMD22P-C, TAMD22P-B



**18-7859
FILTRO COMBUSTIBLE**

Reemplaza: 835576
 Para: AQ175, 200, 226, 266, 290, BB200, 225, 260



**18-8124
FILTRO COMBUSTIBLE**

Reemplaza: 829913
 Para: 2001, 2001B, 2002, 2002B, 2003, 2003B/T/TB, AQD2B, MD11C/D, MD17C/D, MD1B, MD2B, MD3B, MD5A/B/C, MD7/B



**18-7792
FILTRO COMBUSTIBLE**

Reemplaza: 3855104
 Para: Volvo 3.0L (1994-99), OMC 3.0L (1995-98)





18-7964
KIT FILTRO TRANSMISIÓN
 Para: Mercruiser V-8 Intraborda con transmisión hurth



18-7717
ELEMENTO FILTRANTE
 Para: Carburadores Rochester 2 bbl & 4 bbl



18-79007
FILTRO DE AIRE
 Reemplaza: 3825038
 Fits: TAM63L-1, TAM63P-A



18-7689
COMBUSTIBLE INYECTOR
 Reemplaza: 3855182
 Para: 5.7GLPMDA, 5.7GIPMDA, 5.7GIPMDACE, 5.7GLIMDA, 5.7GIIMDA, 4.3GLPHUB, 4.3GSPHUB, 4.3GSPHUS, 4.3GIPHUSCE, 5.7GIPHUS, 4.3GLPNCA, 4.3GLPNCB, 4.3GLPNCS, 4.3GSJNCC, 4.3GSJNCS, 4.3GSPNCA, 4.3GSPNCB, 4.3GSPNCM, 4.3GSPNCS, 4.3GIPNCACE, 4.3GIPNCBCE, 4.3, 5.7GLPNCS, 5.7GIPNCACE, 5.7GIPNCBCE, 5.7GIPNCMCE, 5.7GIPNCBCE, 5.7GIINCCCE, 5.7GIINCSCE, 4.3GLPLKD, 4.3GLPLKE, 4.3GSPDK, 4.3GSPDKCE, 4.3GIPLKE, 4.3GSJLKD, 5.7GLPLKA, 5.7GLPLKD, 5.7GLPLKE, 5.7GLPLKR, 5.7GSPDK, 5.7GSPDKCE, 5.7GLPLKCE, 5.7GIPLKCE, 5.7GSICPLKD, 5.7GSICPLK, 4.3GLPBYC, 4.3GSPBYC, 4.3GIPBYCCE, 4.3GSJBYA, 4.3GIJBYA (1994-07)



18-7685
TBI INYECTOR
 Reemplaza: 3858941
 Para: 4.3GXi-A, 4.3GLPWTC, 4.3GLPWTR, 4.3GSP-WTC, 4.3GSPWTR, 4.3GIPWTC, 4.3GIPWTR, 4.3GI-JWTR, 4.3GSJWTR, 4.3GLPEFS, 4.3GIPEFS



18-7702
SENSOR DE TEMPERATURA
 Reemplaza: 3854527
 Para: 5.0L Gxi-A(2001-02), 5.7L GiL-A (2001), 5.7L Gi-A(2000-01), 5.7L GSiL-A (2000-01), 5.7L Gxi-A(00-01), 5.7L XiL-A (00-01), 5.7L Gxi-B(01-02), Many 7.4L (1994-00), mayoría 8.1L (2005-Actual)



18-7601
SENSOR DE TEMPERATURA AIRE
 Reemplaza: 3854158
 Para: 5.0 Fi/5.8 Fi (1994-96) & 5.0 FL/5.8 FL/5.8 FSi (1995-96)



18-7513
SENSOR DE TEMPERATURA
 Reemplaza: 3862500



18-7647
TRANSMISOR DE TEMPERATURA
 Reemplaza: 872066
 Para: 4.3GL-A, 4.3GL-B, 4.3GL-C, 4.3GL-D, 5.7GL-A, 5.7GL-B, 5.7GL-C, 5.7GL-D, 5.7GL-E, 5.0GL-A, 5.0GL-B, 5.0GL-C, 5.0GL-D, 5.0GL-E, 3.0GLP-A, 3.0GLP-B, 3.0GLM-A, 3.0GLM-B, 3.0GSP-A, 3.0GSP-B, 3.0GSP-C, 3.0GSM-A, 3.0GSM-B, 3.0GSM-C, 3.0GLM-C, 3.0GLP-C, 3.0GLP-D, 4.3GL-E, 4.3GL-EF, 5.0GL-F, 5.0GL-FF, 3.0GLP-E, 4.3GL-G, 4.3GL-GF, 4.3GL-J, 4.3GL-JF, 5.0GL-H, 5.0GL-HF, 3.0GLP-J, 3.0GLP-N, 5.0GL-J, 5.0GL-JF (1998-2007)



18-5897
TRANSMISOR DE TEMPERATURA
 Reemplaza: 3853787
 Para: 5.0L FL, FI, 5.8L FL, FI, FSi



18-5894
INT.LUZ PRESIÓN ACEITE
 Reemplaza: 3852215



18-7700
SENSOR POSICIÓN ACELERADOR
 Reemplaza: 3857487
 Para: modelos 4.3, 5.0, 5.7, 8.1, 8.2L



18-5899
TRANSMISOR PRESIÓN ACEITE
 Reemplaza: 3857532
 Para: 230, 250, 3.0L GLM, GLP, GSM, GSP, 4.3L GL, GXI, OSI, 5.0L GL, GXI, OSI, 5.7L GL, GI, GXI, GIL, GXIL, OSI, OSXI, 8.1L GI, GXI, OSI, GIL



18-7704
IAC MOTOR
 Reemplaza: 3855194
 Modelo: modelos 4.3, 5.0, 5.7, 7.4L



18-7705
IAC MOTOR
 Reemplaza: 3843751
 Para: 4.3GXIE-M



18-7684
SENSOR DE PICADO
 Reemplaza: 3850396
 Para: modelos 4.3, 5.0, 5.7, 7.4L (1994-2007)



18-7677
SENSOR DE GOLPE
 Reemplaza: 3850357
 Para: modelos 4.3, 5.0, 5.7L (2002-07)



18-7703
SENSOR DE GOLPE
 Reemplaza: 3854512
 Para: 7.4, 8.2L (1999-2001)



18-7679
SENSOR DE GOLPE
 Reemplaza: 3854905
 Para: 4.3L (1994-2002), 5.0L Gxi-A (2001-02), 5.7L GiL-A(2001), 5.7Gi-A, 5.7GXi-A, 5.7GXi-B, 5.7GiL-A, 5.7GSiL-A, 5.7GXii-A, 5.7GXii-B(2000-03), 5.7GLPNCS, 5.7GIPNCACE, 5.7GIPNCBCE, 5.7GIPNCMCE, 5.7GIPNCBCE, 5.7GIINCCCE, 5.7GIINCSCE(1995-96)



18-33800
PCV VÁLVULA
 Reemplaza: 3856884
 Para: 4.3L EFI



18-7888
REC.TAPÓN Y JUNTA DRENAJE
Reemplaza: 826648, 862293
Para CAV Filtro

PACK DE 10



ABRAZADERAS

Ref #	Rango	Tamaño
18-8200 ①	.360 - .406	2
18-8201 ①	.410 - .468	4
18-8202 ①	.475 - .536	6
18-8020 ①	.538 - .608	8
18-8021 ①	.597 - .665	10
18-8034 ①	.670 - .780	12
18-8203 ①	.750 - .875	14
18-8204 ①	.875 - .975	19



18-3506
BOMBA DE CIRCULACIÓN
Reemplaza: 21124846



18-3575
BOMBA DE CIRCULACIÓN
Reemplaza: 3854017
Para: Motores 3.0L 4 cil.
Usar junta 18-0327 (incluida)
(Bi-Direccional)



18-3577-1
BOMBA AGUA CIRCULACIÓN
Reemplaza: 3855991, 856609
Para: GM Bloque pequeño V8
Usar junta 18-0903 (incluida)
(Bi-Direccional)



18-3584
BOMBA AGUA CIRCULACIÓN
Reemplaza: 3853796
Para Ford 5.0 y 5.8
Usar junta 18-0147 (incluida)
(Bi-Direccional)



18-3599-1
BOMBA AGUA CIRCULACIÓN
Reemplaza: 3853850, 835390, 856364
Para motores GM V-6 & bloque pequeño V-8
Usar junta 18-0981 (incluida)



18-3586
BOMBA AGUA
Reemplaza: 841640
(Eje de leva montada)
Para: 431A, 500A/B, 501A, 570A, 571A, AQ180, AQ200, AQ200B/C/D/F, AQ250A, AQ211A, AQ225, AQ231A/B, AQ260, AQ255B, AQ260A, AQ271A/B/C/D/, AQ280A, AQ290A



18-0368
KIT JUNTAS DE BOMBA DE CIRCULACIÓN AGUA
Para: B21, B23, AQ120B, AQ125A, AQ140A, BB140A, AQ145A, BB145A



18-2779
MANGUITO DE ESCAPE
Reemplaza: 3852696
D.I. 4" x
Para: 4.3L GL, GS, Gi, GXI, OSI, 5.0L FI, GL, FL, GXI, OSI, 5.7L GL, Gi, GIL, OSI, GXI, OSXI, 5.8L FL, FI, FSI, 7.4L GL, Gi, 8.1L Gi, GXI, OSI, 8.2L GL



18-2780-1
MANGUITO
Reemplaza: 3852741, 3863450
D.I. 4" x
Para: 3.0L GL, GS, Gi, GLM, GLP, GSM, GSP, GS, 4.3L GL, GS, Gi, GXI, OSI, 5.0L FL, FI, GL, GXI, OSI, 5.7L GL, Gi, GXI, OSI, OSXI, GIL, GXIL, 5.8L FL, FI, FSI, 7.4L GL, Gi, GSI, 8.2L GSI



18-2781
MANGUITO ESCAPE
Reemplaza: 3852742
D.I. 4" x
For: 5.0L FL, GL, GXI, OSI, 5.7L GL, Gi, GXI, GIL, GXIL, OSI, OSXI, 5.8L FL, FSI, 7.4L GL, Gi, GSI, 8.1L, 8.2L GL, GSI



18-3106
ACOPLAMIENTO BOMBA AGUA
Reemplaza: 806256, 831009
AQ90, 95, 100, 110, 120A, 115, 130, MB3B, 17C, D



18-3175
ACOPLAMIENTO BOMBA AGUA
Reemplaza: 858467
Para: D31, D32, D41, D42, D43, D44, D300, AD31A, AD31B, AD31D, AD31L-A, AD31P-A, AD31XD, AQAD31A, MD31A, TAMD31A, TAMD31B, TAMD31D, TAMD31L-A, TAMD31M-A, TAMD31P-A, TMD31A, TMD31B, TMD31D, TMDL-A, KAD32P-A, AD41A, AD41B, AD41D, AD41L-A, AD41P-A, AQAD41A, D41A, D41B, D41D, D41L-A, TAMD41A, TAMD41B, TAMD41D, TAMD41H-A, TAMD41L-A, TAMD41M-A, TAMD41P-A, TMD41A, TMD41B, TMD41D, TMD41L-A, KAD42A, KAD42B, KAD42P-A, TAMD42B, TAMD42WJ-A, KAD43P-A, KAMD43P-A, KAD44P-A, KAD44P-B, KAD44P-C, KAMD44P-A, KAMD44P-B, KAMD44P-C, KAD300A, KAMD300A

① Este producto en precio por pieza. Para pedir envasado añadir 9 a la referencia



18-3274
CHAVETA IMPULSOR
Reemplaza: 808007
MD21B, AQD21B, 230A/SP-A/MT, 230A, 230B, 250A, 250B, AQ125B, AQ145B, AQ131A, AQ151, AQ151A, AQ151B, AQ151C, AQ171, AQ171A, AQ171C, 251A



18-3275
KIT IMPULSOR
Volvo 877066
Para: TAMD74A, A-A, A-B (2000-2005); TAMD74C-A, C-B (2000-2005); TAMD74L-A, B (1999-2005); TAMD74P-A, P-B (1998-2005); TAMD75P-A (1998-2005); TAMD71B (1989-2000); TAMD73P-A (1997-1998); TAMD73WJ-A (1997-1999).



18-3504
KIT IMPULSOR
Volvo 3588475
Para: D4-180I-B, D4-180I-C, D4-180I-D, D4-210A-A, D4-210A-B, D4-210I-A, D4-210I-B, D4-225A-B, D4-225A-C, D4-225A-D, D4-225I-B, D4-225I-C, D4-225I-D, D4-260A-A, D4-260A-B, D4-260A-C, D4-260A-D, D4-260D-B, D4-260D-C, D4-260D-D, D4-260I-A, D4-260I-B, D4-260I-C, D4-260I-D, D4-300A-A, D4-300A-C, D4-300A-D, D4-300D-A, D4-300D-C, D4-300D-D, D4-300I-A, D4-300I-C, D4-300I-D



18-3276-1
KIT IMPULSOR
Reemplaza: 3862567, 21213660
Para: Volvo (1999 y posteriores)



18-3277
KIT IMPULSOR
Reemplaza: 3862281, Yanmar 192470-42530, 192470-42532
Para: Volvo (1998 y anteriores), Johnson Pump 09-812B-1



18-3047
KIT IMPULSOR
Reemplaza: 835874
Sherwood 10615K,
Jabsco 18948-0001
12 PALAS



18-3060
IMPULSOR
Reemplaza: 835512, 3854286
Sherwood 9959,
Jabsco 18838-0001
Oberdorfer 132-0317
OMC 3854286
Neopreno, 12 PALAS



18-3046
IMPULSOR
Reemplaza: 3854286

① 18-3046D 



18-3061
IMPULSOR
Reemplaza: 835874,
Sherwood 0615K,
Jabsco 18948-0001
Neopreno
12 PALAS
Para: Motores con GM V-COREA



18-30778
IMPULSOR
Reemplaza: 21213664
Para: Motores Gas GM 2005 & Sup



18-3075
KIT IMPULSOR
Reemplaza: 875575, Jabsco 2877-0001, 4568-0001, Johnson 09-801B, Oberdorfer B6620
12 palas
Neopreno

① 18-3075D 



18-3076
KIT IMPULSOR
Reemplaza: 875583, 833995
Jabsco 22405-0001
Bomba Johnson 09-45589, 09-808B
6 Palas, Neopreno



18-3077 (Neopreno) **18-3038** (Nitrilo)
KIT BOMBA AGUA
Reemplaza: 877061-2, 3841697
Para: AQ 30, 31, 40, 41 AQD 19, 27, 29, 32, KAD/KAMD 42A, B, P, MD, 19, 27, 29, 32, TAMD 60A, B, C



18-3078 (Neopreno) **18-3037** (Nitrilo)
KIT BOMBA AGUA
Reemplaza: 875736, 875660, 2430184
Jabsco 836-0003,
Johnson Pump 09-1029B-9
Para: AQ, AD 40 A, B, TAMD 40 A, B, TAMD 61-62 A, 71-72A



18-3287
KIT IMPULSOR
Reemplaza: 876120
Para: 431A, BB231A, 570A, 571A, 572A, 740A, 740B, AQ200D, AQ205A, AQ225D, AQ255B, AQ260A, AQ260B, AQ271A, AQ271B, AQ271C, AQ271D, AQ280A, AQ290A, AQ311A, AQ311B, BB225A, BB225AV, BB225B, BB260A, BB260AV, BB261A



18-3079
KIT IMPULSOR
Reemplaza: 875807-0, 3586498
bomba Johnson 09-806B Sherwood 9979K
6 palas
Neopreno
Jabsco 4528-0001
Anchura lateral 3/4" Dia. 1 9/16"



18-3080
(Neopreno)

KIT BOMBA AGUA

Volvo 875808, 3593659
Jabsco 673-0001

Bomba Johnson 09-1026B-1

Para: AQ 60, 80, 90, 95, 100, 105, 110, 115, 120A, 130, B 16, BB 25, 30, 70, 100, MB 18, 20, MD 3B, 17C, D, ND2010B, 2020B, 2030B, 2040BC

18-3036
(Nitrilo)

Jabsco 673-0003

Johnson Pump 09-1026B-9

① **18-3081D**

Display Package



18-3081

KIT IMPULSOR

Reemplaza: 875811-2,

3858256, 3862281

OMC 3858256

Bomba Johnson 09-1027B

Neopreno

12 Estrias 12 Palas

Jabsco 1210-0001



18-3089

KIT BOMBA AGUA

Reemplaza: 09-45825

Bomba Johnson

Para bomba 18-3587

18-30777

KIT IMPULSOR

Reemplaza: 3841697

Para: D70CHC, D70CRC, TD70CHC, TD70 CRC, KAD42P-A, KAD42, KAMD42, KAMD42P-A, DPX, HS1A, DP-D1, DP-E, DP-G, KAD32P, TAMD42WJ-A, KAD43P, KAMD43P, KAD44P, KAMD44P, KAD300, KAMD300, MD100A, TMD100A, MD100B, MD120, TMD120A, TMD120AK, TAMD120A, TAMD120AK, TMD120B, TAMD120B, TAMD120B-CC, TAMD60A, TAMD60B, TMD31L, TAMD31P/L/M/S, AD31P/L, TMD41L, TAMD41P/L/M/H, TAMD60C, MD70B, MD70BK, TMD70B, THAMD70B, TAMD70B, AQD70BL, AQD70B, MD70C, TMD70C, TAMD70C, THAMD70C, AQD70C, TAMD70D, AQD70D, TAMD70E, AD30A, AQAD30A, MD30A, TAMD30A, TMD30A, AD30, AQAD30, MD30, TAMD30, TMD30, MD40, TMD40, AQD40, TAMD40, AQAD40, TMD41, D41A, TAMD41, AQAD41A, AD41A, AD41B, 290A, DP-A, DP-B, DP-1A, DP-B1, SP-A, SP-A1, TMD121C, TAMD121C, TAMD121D, TAMD122C, TAMD122D, MD31A, TMD31B, TAMD31B, AD31B, TMD41B, D41B, TAMD41B, AD31B, TMD41B, D41B, TAMD41B, AD41B, KAD42A, KAMD42A, DP-D, MS5B, AD31D, AD31XD, TAMD31D, TMD31D, AD41D, D41D, TAMD41D, TMD41D, DP-D1, DP-E, DP-S, DPX, SP-C1, HS1A, KAD42B, KAMD42B, TAMD42B.



18-3205

KIT REPARACIÓN

Reemplaza: 875574

AQ120B, 125A, B, 131A, 140A, 145A, B, 151A, B



18-3208

KIT REPARACIÓN BOMBA AGUA

Reemplaza: 875584

MD5A, B, C, MD6B, MD7A, B, MD11C, D



18-3209

KIT REPARACIÓN BOMBA AGUA

Reemplaza: 875383

AQ165A, 170A, B, C, MD21A (S/N MD103387 & SUP), MD21B



18-3261

KIT REPARACIÓN BOMBA AGUA

Reemplaza: 875769

Para: D40, AD40B, AQAD40A, AQAD40B, TAMD40A, TAMD40B



18-3262

KIT REPARACIÓN BOMBA AGUA

Reemplaza: 875759

Para bombas de agua salada: Para: D30, D31, D32, D40, D41, D42, D43, D44, AD30A, AQAD30A, TAMD30A, TMD30A, AD31A, AD31B, AD31D, AD31XD, AQAD31A, MD31A, TAMD31A, TAMD31B, TAMD31D, TMD31A, TMD31B, TMD31D, KAD32P-A, AQD40A, MD40A, TMD40A, TMD40B, TMD40C, AD41A, AD41B, AD41D, AQAD41A, D41A, D41B, D41D, TAMD41A, TAMD41B, TAMD41D, TMD41A, TMD41B, TMD41D, KAD42A, KAD42B, KAD42P-A, KAMD42A, KAMD42B, KAMD42P-A, TAMD42B, TAMD42WJ-A, KAD43P-A, KAMD43P-A, KAD44P-A, KAMD44P-A



18-3263

KIT REPARACIÓN BOMBA AGUA

Reemplaza: 875698

Para bombas agua salada: Para: B18, B20, D3, D17, AQ60F, AQ90, AQ95A, AQ110, AQ120, BB30, BB100, MB18, AQ105A, AQ115A, AQ115B, AQ130A, AQ130B, AQ130C, AQ130D, BB115, BB115B, BB115C, MB20A, MB20B, MB20C, MD3B, MD17C, MD17D,

DIÁMETRO MANGUITO ÚNICO

 <p>18-70021 MANGUITO 3/4" DI</p> <p>4 3/4"</p>	 <p>18-70704 MANGUITO 1 1/4" DI</p> <p>5"</p>	
 <p>18-70924 MANGUITO 1 3/4" DI</p> <p>5"</p>	 <p>18-71218 MANGUITO 1" DI</p> <p>12 1/2"</p>	 <p>18-71337 MANGUITO 1 3/4" DI</p> <p>12 3/4"</p>

MANGUITO RECTO

 <p>18-75100 MANGUITO Recto 48" 1" DI</p>	 <p>18-75125 MANGUITO Recto 48" 1 1/4" DI</p>
---	---

CORREAS

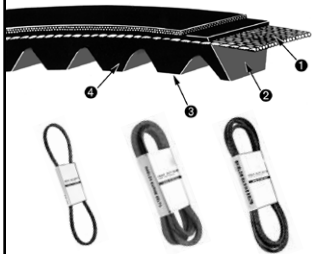

- 1** Cordón sintético de alta resistencia, Garantizan un comportamiento uniforme.
- 2** Compuesto especial de goma que asegura una suave transferencia de las fuerzas a la cuerda.
- 3** Dientes especialmente diseñados para mejorar la flexibilidad y mantener al mismo tiempo de resistencia. La forma geométrica de los dientes previenen de las rozaduras.
- 4** Los bordes de goma mantienen un contacto suave con las poleas de manera que la transferencia de energía sea efectiva.

TAMAÑO CORREA LISTADA POR REFERENCIA

Ref #	Longitud Efectiva (Pulg.)	Anchura (Pulg.)	Ref #	Longitud Efectiva (Pulg.)	Anchura (Pulg.)	Ref #	Longitud efectiva (Pulg.)	Anchura (Pulg.)
18-15290	29	29/64	18-15405	40 1/2	29/64	18-15460	46	29/64
18-15300	30	29/64	18-15410	41	29/64	18-15470	47	29/64
18-15325	32 1/2	29/64	18-15415	41 1/2	29/64	18-15480	48	29/64
18-15345	34 1/2	29/64	18-15430	43	29/64	18-15495	49 1/2	29/64
18-15370	37	29/64	18-15435	43 1/2	29/64	18-15500	50	29/64
18-15380	38	29/64	18-15440	44	29/64	18-15520	52	29/64
18-15390	39	29/64	18-15450	45	29/64	18-15550	55	29/64
18-15400	40	29/64	18-15455	45 1/2	29/64			

CRUCE DE REFERENCIAS DE LAS CORREAS

Ref #	Volvo #	Ref #	Volvo #	Volvo #	Ref#	Volvo #	Ref #
18-15325	958303	18-15460	829207	829207	18-15460	985357	18-15415
18-15390	958310	18-15460	950818	841821	18-15430	958498	18-4046
18-15405	958311	18-15495	958320	950813	18-15410	966694-2	18-4044
18-15410	950813	18-15500	952141	950818	18-15460	966857	18-4046
18-15415	985357	18-4046	958498	952141	18-15500		
18-4044	966694-2	18-4046	966857	958303	18-15325		
18-15430	841821			958310	18-15390		
18-15435	958314			958311	18-15405		
18-15435	966382			958314	18-15435		
18-15450	3858462			958320	18-15495		
18-15455	3852464			966382	18-15435		

CRUCE DE REFERENCIAS DE LOS MANGUITOS

Ref #	Volvo #	Ref #	Volvo #	Volvo #	Ref #	Volvo #	Ref #
18-70704	838513	18-75125	826423	826423	18-75125	845792	18-75125
18-70704	856306	18-75125	845792	838513	18-70704	856306	18-70704

Fits GM Small Block V8 305-350 cu. in. Models AQ & BB 200, 205, 211, 231, 225, 260, 271, 290, 311, 500, 501, 570, 571 & 572

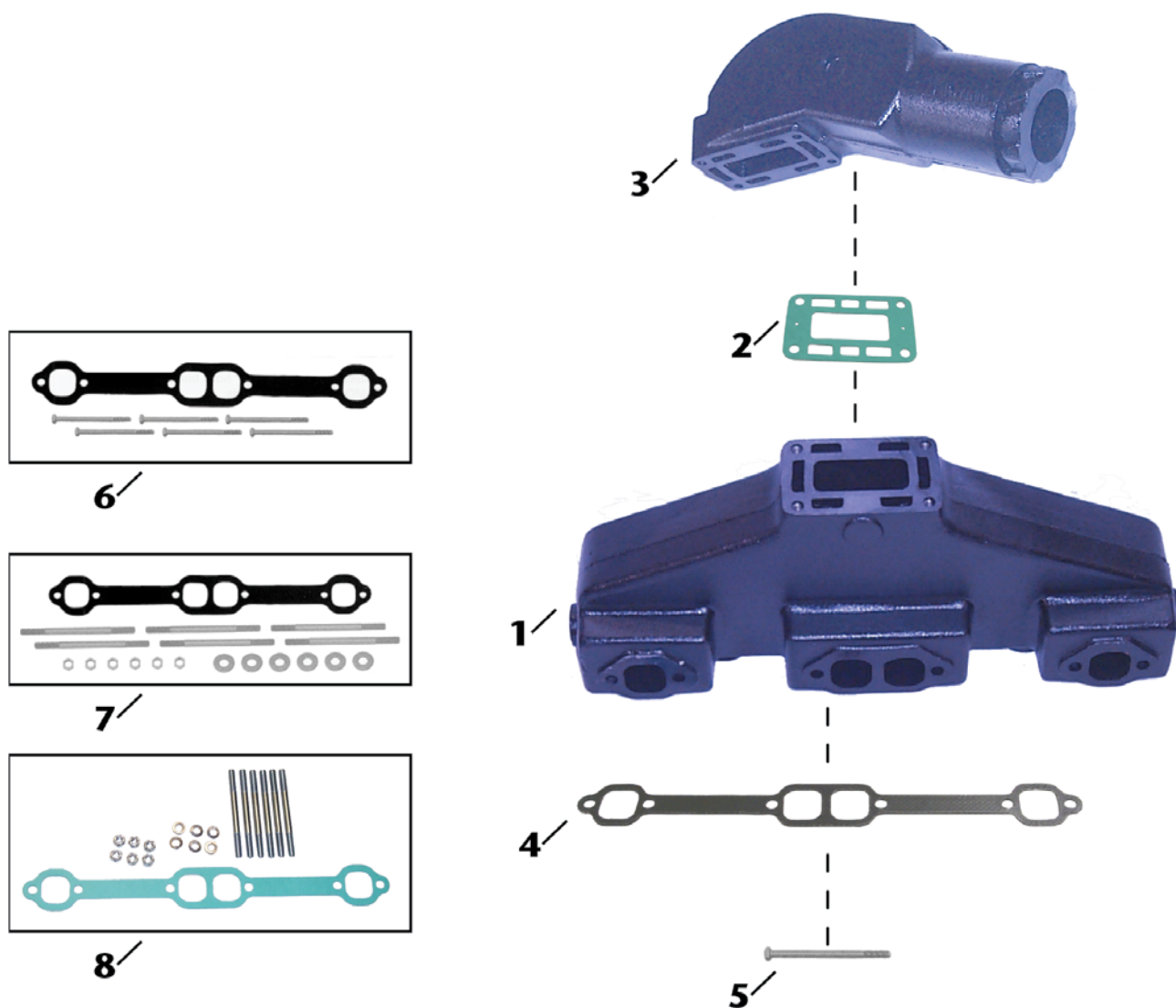

Ref	Descripción	OE No.	Aplicación
1	18-1931-1 COLECTOR ESCAPE	835804-6	GM Bloque pequeño (V8) 305-350 cu.in. Modelo AQ & BB 200, 205, 231, 225, 260, 271, 290, 311, 500, 501, 570, 571, & 572. Usar con Junta colector: 18-2949; Kit montaje: 18-8511.
2	18-2971-1 JUNTA CODO ESCAPE	856039-3	Usar con colector: 18-1931-1; Elbow: 18-1935-1
3	18-1935-1 CODO ESCAPE	855384-4	Usar con colector: 18-1931-1; Elbow Gasket: 18-2971-1.
4	18-2949 JUNTA COLECTOR ESCAPE	N/D	Usar con colector: 18-1931-1; kit de montaje 18-851.
5	NSI TORNILLO MONTAJE	N/D	Incluido en 18-8511 kit montaje.
6	18-8511 KIT MONTAJE	N/D	Usar con colector: 18-1931-1.
7	18-8502 KIT MONTAJE	N/D	Usar con colector: 18-1931-1. Incluye tornillos montaje.
8	18-8502 KIT MONTAJE	N/D	Usar con colector: 18-1931-1. Incluye tornillos montaje.

Fits GM V6 (1993 & Before) AQ 175, 205, 430A/B, 431, 434

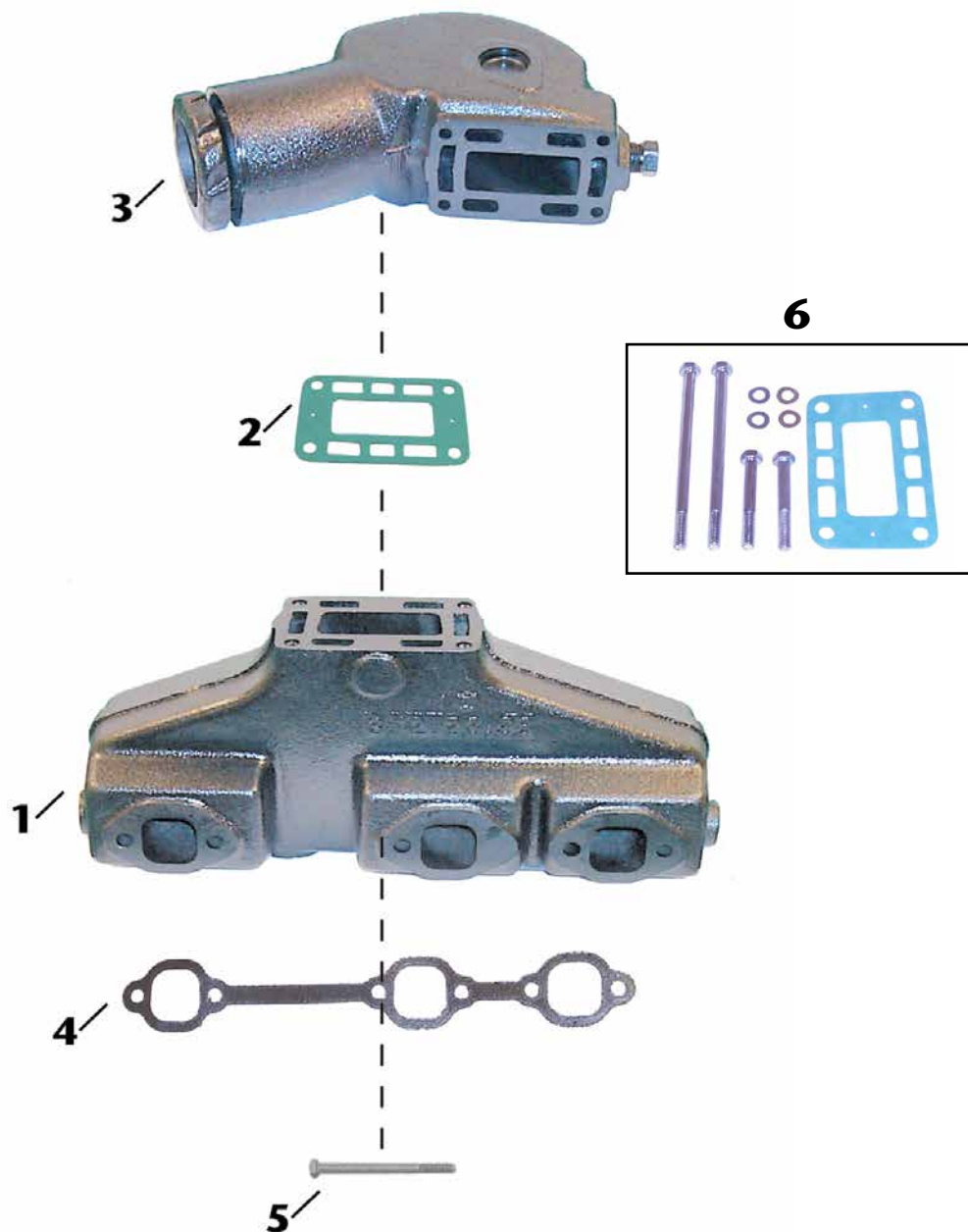

Ref	Descripción	OE No.	Aplicación	
1	18-1932	COLECTOR DE ESCAPE	856894-1	GM (V6) (1993 & anterior) Modelo AQ 175, 205, 430 A/B, 432, 434. Usar con junta colector escape 18-2909.
2	18-2971-1	JUNTA CODO ESCAPE	856039-3	Usar con colector: 18-1932; codo: 18-1936.
3	18-1936	CODO ESCAPE	857037-6	Usar con colector: 18-1932; junta codo: 18-2971-1
4	18-2909	JUNTA COLECTOR	N/D	Usar con colector: 18-1932.
5	NSS	TORNILLO MONTAJE	N/D	Usar para fijar 18-2909 a 18-1932.
6	18-19360	KIT TORNILLO	N/D	Usar con codo 18-1936

COLECTORES DE ESCAPE SIERRA ESTÁN PINTADOS, EMPAQUETADOS Y A PRUEBA DE FUGAS



18-1848
COLECTOR
Reemplaza: 3857656, 3847499
Para: Volvo 4.3L V-6



18-1898
COLECTOR
Babor & Estribor
Reemplaza: Barr CHVA-1-84, Marine Power 0991-110
Para 454 cu.in. GM bloque grande motores V8
Usar con:
Usar con: Junta colector escape: 18-0418



18-1930-2
COLECTOR DE ESCAPE
Reemplaza: 855387, 834438-4
Para: Volvo AQ120B, 125A, 140A, 145A, BB140A, 145A
Suministrado con pack de montaje
Usar con:
Junta colector escape: 18-2991-1
Kit montaje: 18-8539



18-1931-1
COLECTOR DE ESCAPE
Babor & Estribor
Reemplaza: 835804, 856883
Para: Volvo AQ200D, 200F, 225D, 225E, 225F, 255B, 260A, 271A, 280A, 290A, 311A, AQ500, 570: BB225, 225AV, 225B, 260A, 260AV, 260B, 260C
Suministrado con pack de montaje
Usar con:
Kit montaje: 18-8511



18-1986-1
COLECTOR DE ESCAPE
Babor & Estribor
Reemplaza: 3852374-2, 3857723, 3847501
Para: 5.0L & 5.7L GM (Nuevo estilo)
Usar con:
Junta colector escape: 18-2949
Kit montaje: 18-8502



18-1932
COLECTOR ESCAPE
Babor & Estribor
Reemplaza: 856894
Para: 4.3L Para: AQ175, AQ430, AQ431A, AQ431B, AQ432, AQ434
Usar con:
Junta colector escape: 18-2909



18-1997-1
COLECTOR
Babor & Estribor
Reemplaza: Barr CHV-1-83
Colector para codo central
Para: GM 283, 305, 307 and 350 CID engines
Usar con:
Juego juntas colector escape: 18-0604



18-1936
CODO ESCAPE
Reemplaza: 857037
Para: 4.3L Para: AQ175, AQ430, AQ431A, AQ431B, AQ432, AQ434
Usar con:
Junta codo escape: 18-2971-1
Kit montaje: 18-19360



18-1999
CODO
 Reemplaza: Barr 20-0082
 Viene con 18-4364 kit codo escape (abierto)
 Para montaje cerrado use 18-8535
 Reemplaza: Barr 20-0082-P
 Usar con:
 Colector: 18-1997-1
 Junta codo: 18-2854-1 abierto o 18-0476-1 cerrado



18-1935-1
CODO ESCAPE
 Reemplaza: 855384-4, 856891
 Usar con:
 Colector: 18-1931-1
 Junta codo escape: 18-2971-1
 Kit montaje: 18-8510



18-1909-1
CODO ESCAPE
 Reemplaza: OMC 913784, 3855270, 3850456, Volvo 3855270-9, 3863061
 OMC codo, 4" Salida 7°
 Para mayoría GM & Ford colector codo centrado.
 Usar con:
 Colector: 18-1986-1 & 18-1848
 Junta codo: 18-0943-2 abierto
 Kit montaje: 18-8507 abierto



18-1939
CODO ESCAPE
 Para usar con manguera escape 3 1/2" D.I.
 Reemplaza: Barr 20-0100, Marine Power 0992-593 Barr, Indmar, y Marine Power Ford bloque pequeño V8 302-351cu.in., GM bloque pequeño V8 305-350cu.in., GM bloque grande V8 454cu.in. Usar con:
 Colector: 18-1997-1, 18-1998-1
 Junta codo escape: 18-2854-1 18-0476-1 cerrado
 Kit montaje: 18-4364 abierto o 18-8535 cerrado



18-1907
CODO ESCAPE
 Para usar con manguera escape 3" D.I.
 Reemplaza: Barr 20-0102, Indmar 53-2009, 53-2018 Barr y Indmar Ford bloque pequeño V8 302-351cu.in.
 Usar con:
 Colector: 18-1997-1, 18-1998-1
 Junta codo escape: 18-2854-1 abierto o 18-0476-1 cerrado
 Kit montaje: 18-4364 abierto o 18-8535 cerrado



18-1991
ADAPTADOR CODO ESCAPE
 Para usar con manguera escape 3" D.I.
 Usar con:
 Prolongador de altura colector: 18-1999 30°



18-1992-1
ADAPTADOR CODO ESCAPE
 Para manguera escape 3" D.I.
 (Como utilizado en el kit de conversion 18-1987)
 80°



18-4007
CODO ESCAPE
 Reemplaza: 845261
 Para: D30, D40, AD30A, AQAD30, TAMD30A, TMD30A, AD40B, AQAD40A, AQAD40B, AQD40A, TAMD40A, TAMD40B, TMD40A, TMD40B, TMD40C



18-1949
ESPACIADOR COLECTOR ESCAPE
 Barr, Indmar y Marine Power Ford bloque pequeño V8 302-351cu.in., GM bloque pequeño V8 305-350cu.in., GM bloque grande V8 454cu.in.
 Usar con:
 Colector: 18-1998-1, 18-1997-1, 18-1898



18-4364 (Abierto)
KIT CODO ESCAPE
 Reemplaza: Barr 20-0082-P
 Usar con:
 Codo escape: 18-1999, 18-1907, 18-1939



18-8502
KIT MONTAJE COLECTOR ESCAPE
 OMC GM bloque pequeño V8 305-350cu. in. (1979-89) OMC/Volvo GM Bloque pequeño 305-350cu.in.
 Usar con:
 Colector: 18-1931-1,18-1902, 18-1903 & 18-1986-1



18-8507
KIT MONTAJE CODO ESCAPE
 OMC/Volvo GM Bloque pequeño V8 305-350 cu.in.
 Usar con:
 Codo escape: 18-1909-1



18-8510
KIT MONTAJE CODO ESCAPE
 Volvo GM bloque pequeño V8 305-350 cu.in.
 (Modelos: AQ y BB200, 205, 211, 231, 225, 260, 271, 290, 311, 500, 501, 570, 571, 572)
 Usar con:
 Codo escape: 18-1935-1



18-8511
KIT MONTAJE COLECTOR ESCAPE
 Volvo GM bloque pequeño V8 305-350 cu.in. (Modelos: AQ y BB200, 205, 211, 231, 225, 260, 271, 290, 311, 500, 501, 570, 571, 572)
 Usar con:
 Colector 18-1931-1

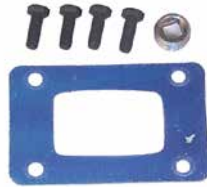

18-8535 (Cerrado)
KIT MONTAJE CODO ESCAPE
 Barr, Indmar y Marine Power Ford bloque pequeño V8 302-351cu.in., GM bloque pequeño V8 305-350cu.in., GM bloque grande V8 454cu.in.
 Usar con:
 Codo: 18-1939, 18-1999, y 18-1907



18-8536
KIT MONTAJE CODO ESCAPE
 Barr, Indmar y Marine Power GM bloque pequeño V8 305-350cu.in.
 Usar con:
 Colector: 18-1997-1



18-8538
KIT MONTAJE COLECTOR ESCAPE
 Barr y Indmar Ford bloque pequeño V8 302-351cu.in.
 Usar con:
 Colector: 18-1998-1



18-8539
KIT MONTAJE COLECTOR ESCAPE
 Volvo 4 Cilindro B20 2.3 y 2.5L (Modelos: AQ 120, 125, 131, 140, 145, and 151. BB140, 145, 230, y 250) Volvo 4 Cilindro B20 2.3 y 2.5L (Modelos: AQ 120, 125, 131, 140, 145, y 151. BB140, 145, 230, y 250)
 Usar con:
 Colector: 18-1930-2



18-19360
KIT MONTAJE
 Usar con:
 Codo escape: 18-1936

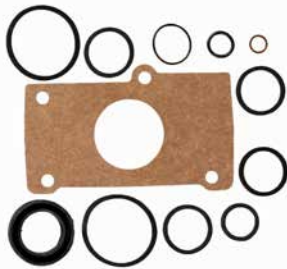

18-0146
JUEGO DE JUNTAS
 Para: B21, B23, AQ120B, AQ125A, AQ140A, BB140A, AQ125B, AQ145A, AQ145B, BB145A

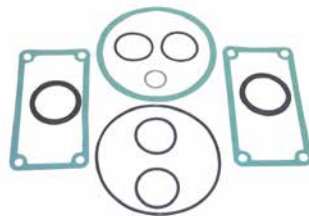

18-0337
JUEGO DE JUNTAS
 Para: AD40B, AQAD40A, AQAD40B, TAMD40A, TAMD40B, TMD40B, TMD40C

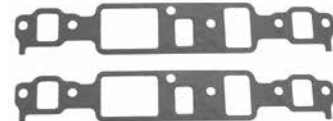

18-4408
JUEGO JUNTAS COLECTOR ADMISIÓN
 Reemplaza: 3850379
 Para: 4.3L GL, GS, GI



18-0476-1 (Cerrado)
JUNTA CODO ESCAPE
 Reemplaza: Barr 01-0105 Indmar & Marine Power Ford bloque pequeño V8 302-351cu.in.
 Usar con:
 Junta codo escape: 18-1939, 18-1999 & 18-1907



Pack de 2
18-2854-1 (abierto)
18-2854-9①
JUNTA CODO ESCAPE
 Reemplaza: Barr 01-0107
 Usar con:
 Colector: 18-1999, 18-1939, 18-1907



Pack. de 2
18-2875-1
18-2875-1-9①
JUNTA CODO ESCAPE
 Reemplaza: 3850495
 Para: 3.0L GS, GL, GLM, GLP, GSM, GSP

Pack. de 2



18-2902-1
18-2902-9①
JUNTA COLECTOR
Reemplaza: 3852468
Para: 5.0L GL, GXI, OSI, 5.7L GL, GI, GXI, GIL, GXIL, OSI, GXIL, OSXI

Pack. de 2



18-2949
18-2949-9①
JUNTA COLECTOR ESCAPE
Reemplaza:
Barr CHV-47-000
Usar con:
Colector: 18-1986-1,
18-1997-1 and 18-1931-1
AQ200, 225, 260, 271, 290, 311



18-2971-1
JUNTA COLECTOR ESCAPE
Reemplaza: 835908-5, 856039-3
Usar con:
Codo escape: 18-1935-1

Pack. de 4



18-2991-1
18-2991-9①
JUNTA COLECTOR ESCAPE
Reemplaza: 855967, 855383
Usar con:
Colector escape: 18-1930-2
AQ200, 225, 260, 271, 290, 311



18-4461
CONECTOR MANGUITO
3/4" - 14 NPT x 1" Manguera
Latón resistenten a la corrosión



TAPONES

Ref #	Diámetro rosca
18-4256	1/4"
18-4257	1/4"
18-4258	3/4"
18-4263	1/8" - 27 NPT
18-4264	3/8" - 18 NPT

TAPÓNES DRENAJE

Ref #	Reemplaza:
18-4216	807036
18-4217	82744
18-4218	82745
18-4218D②	
18-4219	829592
18-4697	
18-4699	
18-3223-9 ③	

Pack de 12 (18-4218)
para mayoría de colectores originales OEM













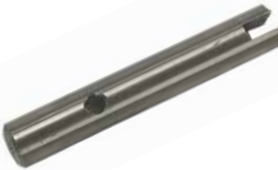





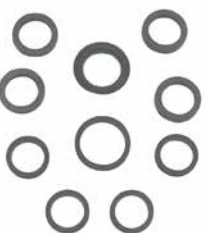

APLICACIÓN TAPÓN DRENAJE

Modelo	Tamaño rosca	Localización	Tapón
MD1A,B,2A,B,3B,5A,B,MD6A	10 x 1	Bloque cil	18-4216
AQ90,95,100,105,110,115,120,130,140A,145A,B, 151A,B,170,171A,MB18,20,BB30,100,MD19,21,32	1/8" NPT	Bloque cil	18-4217
AQ90,95,100,110,115,120,125A,B,130,131A,140A,145A,B, 151A,B,171A,MB18,MB20,BB30,100,AQD40,AQAD40,TMD40	1/4" NPT	Bloque cil	18-4218
MD5C,11C,D,17C,D	1/8" NPT	Bloque cil	18-4219
B18, B20, B21, B23, B25, B30, D31,	1/4" NPT	Refrig. aceite	18-4699
D40, 2001, 2002, 2003 V6, B23, B25, D30, D31, D40, D41	1/4" NPT	Refrig.aceite	18-4697

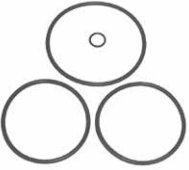
① Precio por pack
② Referencias acabadas en "D" envasadas - Referencia normal no envasada
③ Este producto es precio por pieza. Para pedir precio por pack, Añadir -9 a la referencia

Modelo	Colector Escape	Codo Escape	Kits montaje Colector	Kits codo escape	Junta Colector	Junta codo
230	18-1930-2	-	18-8539	-	18-2991-1	-
250	18-1930-2	-	18-8539	-	18-2991-1	-
AQ120B	18-1930-2	-	18-8539	-	18-2991-1	-
AQ125A	18-1930-2	-	18-8539	-	18-2991-1	-
AQ131A,B,C,D	18-1930-2	-	18-8539	-	18-2991-1	-
AQ140A	18-1930-2	-	18-8539	-	18-2991-1	-
AQ145A,B	18-1930-2	-	18-8539	-	18-2991-1	-
AQ151A,B,C	18-1930-2	-	18-8539	-	18-2991-1	-
AQ200C,D/280	18-1931-1	18-1935-1	18-8511⑤/18-8502⑥	18-8510	18-2949	18-2971-1
AQ200D,F	18-1931-1	18-1935-1	18-8511⑤/18-8502⑥	18-8510	18-2949	18-2971-1
AQ225C,D/280	18-1931-1	18-1935-1	18-8511⑤/18-8502⑥	18-8510	18-2949	18-2971-1
AQ225D,E,F	18-1931-1	18-1935-1	18-8511⑤/18-8502⑥	18-8510	18-2949	18-2971-1
AQ255A,B/280	18-1931-1	18-1935-1	18-8511⑤/18-8502⑥	18-8510	18-2949	18-2971-1
AQ260A,B	18-1931-1	18-1935-1	18-8511⑤/18-8502⑥	18-8510	18-2949	18-2971-1
AQ290A	18-1931-1	18-1935-1	18-8511⑤/18-8502⑥	18-8510	18-2949	18-2971-1
AQ430	18-1932	18-1936	-	-	18-2909	18-2971-1
AQ431	18-1932	18-1936	-	-	18-2909	18-2971-1
AQ432	18-1932	18-1936	-	-	18-2909	18-2971-1
AQ434	18-1932	18-1936	-	-	18-2909	18-2971-1
BB140A	18-1930-2	-	18-8539	-	18-2991-1	-
BB145A	18-1930-2	-	18-8539	-	18-2991-1	-
BB225A,B,C	18-1931-1	18-1935-1	18-8511⑤/18-8502⑥	18-8510	18-2949	18-2971-1
BB260A,B,C	18-1931-1	18-1935-1	18-8511⑤/18-8502⑥	18-8510	18-2949	18-2971-1
500B	-	18-1936	-	-	18-2909	18-2971-1
501B	-	18-1936	-	-	18-2909	18-2971-1
570	18-1931-1	18-1935-1	-	-	18-2909	18-2971-1
572	-	18-1936	-	-	18-2909	18-2971-1
740B	-	18-1936	-	-	18-2909	18-2971-1
LK 4.3L	-	18-1936	-	-	18-2909	18-2971-1
LK 5.7L	18-1986-1	18-1909-1	18-8502	18-4364⑦/18-8535⑧	18-2949	18-2854-1⑦/18-0476-1⑧
HU 5.7 Gi	18-1986-1	18-1909-1	18-8502	18-4364⑦/18-8535⑧	18-2949	18-2854-1⑦/18-0476-1⑧
MD 5.7GL / 5.7Gi	18-1986-1	18-1909-1	18-8502	18-4364⑦/18-8535⑧	18-2949	18-2854-1⑦/18-0476-1⑧
NC5.7 GL / 5.7Gi	18-1986-1	18-1909-1	18-8502	18-4364⑦/18-8535⑧	18-2949	18-2854-1⑦/18-0476-1⑧

⑤ Configuración Volvo Match (Tornillos en el Kit) ⑦ Junta abierta
⑥ Configuración OMC Match (Tuercas en el Kit) ⑧ Junta cerrada

<p>Pack de 5</p>  <p>18-4236 18-4236-9① ARANDELA Reemplaza: 941907</p>	 <p>18-4150 EJE BOMBA AGUA Reemplaza: 812994 Para bomba sin cojinete a bolas AQ90, 95, 100, 105, 110, 115, 120, 130, MD3B, 17C</p>	 <p>18-2774 MANGUITO Reemplaza: 875847 AQ290, AQ290DP Incluye (2) 18-7306 abrazaderas</p>	 <p>18-2775 MANGUITO Reemplaza: 875822 AQDRIVE UNITS 200, 250, 270, 270T, 275, 280, 280T, 280PT, DP UNIT: 280 Incluye (2) 18-7306 abrazaderas</p>
 <p>18-2776 MANGUITO Reemplaza: 832831 AQ270T, 280T Incluye (2) 18-7306 abrazaderas</p>	 <p>18-0163 JUEGO JUNTAS PIPETA REFRIGERACIÓN Para: B30, AQ165A, AQ170A, AQ170B, AQ170C, BB165A, BB170A, BB170B, BB170C</p>	 <p>18-0376 JUEGO JUNTAS PIPETA REFRIGERACIÓN Para: D6, D7, MD6A, MD6B, MD7A, MD7B</p>	 <p>18-0377 JUEGO JUNTAS PIPETA REFRIGERACIÓN Para: B21, B23, AQ120B, AQ125A, AQ140A, BB140A, AQ125B, AQ145A, AQ145B, BB145A</p>
 <p>18-0590 JUEGO JUNTAS PIPETA REFRIGERACIÓN Para: B20, AQ125A, AQ115B, AQ130A, AQ130B, AQ130C, AQ130D, BB115A, BB115B, BB115C</p>	 <p>18-0648 JUEGO JUNTAS PIPETA REFRIGERACIÓN Para: D11, D17, MD11C, MD11D, MD17C, MD17D</p>	 <p>18-3889 JUEGO JUNTAS PIPETA REFRIGERACIÓN Para: B23, B25, 230A, 230B, AQ131A, AQ131B, AQ131C, AQ131D, 250A, 250B, 251A, AQ151A, AQ151B, AQ151C, AQ171A, AQ171C</p>	 <p>18-0606 JUEGO JUNTAS PIPETA REFRIGERACIÓN Para: B18, B20, AQ60F, AQ90, AQ95, AQ95A, AQ110, AQ120, BB30, BB100, MB18, AQ105A, MB20A, MB20B, MB20C</p>
 <p>18-0907 JUEGO JUNTAS DRENAJE ACEITE Para tapón aceite: Para: 200, 250, 270, 270T, 275, 275A</p>	 <p>18-3890 JUEGO JUNTAS REFRIGERACIÓN Para: B20, B21, B23, B25, B30, AQ115A, AQ115B, AQ130A, AQ130B, AQ130C, AQ130D, BB115A, BB115B, BB115C, MB20A, MB20B, MB20C, AQ120B, AQ125A, AQ140A, BB140A, 230A, 230B, AQ145A, AQ145B, BB145A, 250A, 250B, 251A, AQ151A, AQ151B, AQ151C, AQ171A, AQ17C, AQ165A, AQ170A, AQ170B, AQ170C, BB165A, BB170A, BB170B, BB170C</p>	 <p>18-2777 JUEGO JUNTAS REFRIGERACIÓN Reemplaza: 854031 *AQ120B, *AQ125A, B, AQ130A, B, D, *AQ130C, *AQ131A, AQ140A, AQ145A, *AQ165A, *AQ170A, B, C, *AQ175A, AQ200D, AQ225D, *AQ225E, AQ260A, AQ260B, AQ290A, *AQAD31A. AQD40A, AQD21A, AQAD40A * Modelos con Power Trim</p>	 <p>18-2778 ALOJ. TERMOSTATO Reemplaza: 832846 AQ140A, AQ145A, AQ165A, AQ170A, *AQ175D, AQ200D, AQ225D, AQ260A, AQ290A, *AQ280L, AQAD30A, AQAD40A, B *Modelos con Power Trim</p>
 <p>18-3557 TERMOSTATO Reemplaza: 21148403 143°</p>	 <p>18-3558 TERMOSTATO Reemplaza: 3853799 160°</p>	 <p>18-3654 KIT TERMOSTATO (60°C) Reemplaza: 875779 140°</p>	 <p>18-3539 KIT TERMOSTATO Sistema refrigeración cerrado (Incluye aro sellador) Reemplaza: 3831426 160°</p>

① Precio por pack



18-3538
KIT TERMOSTATO
 (Incluye aro sellador)
 Reemplaza: 3831424

① **18-3676D** 



18-3676
KIT TERMOSTATO
 Reemplaza: 3853983
140°
 — **Contiene** —

Ref #	OE#	Descripción
18-7170	3852071	Aro
18-0398	835417	Junta
—	3853983	Termostato

① **18-3670D** 



18-3670
KIT TERMOSTATO
160°
 — **CONTIENE** —

Ref #	O.E.#	Desc.
18-3558	3853799	Termostato
18-2858	3852127	Junta tapa aloj. termostato
18-0929	3852120	Junta termostato

① **18-3677D** 



18-3677
KIT TERMOSTATO
 Reemplaza: 3856961
160°
 — **Contiene** —

Ref #	OE#	Descripción
18-7170	3852071	Aro tórico
18-0398	835417	Junta
—	3856961	Termostato



18-3656
KIT TERMOSTATO
140°
 Reemplazo: 876097, 875781





18-3658
KIT TERMOSTATO
165°
 Reemplaza: 875784, 877349



18-3659
KIT TERMOSTATO
160°
 Reemplaza: 875785



18-3660
KIT TERMOSTATO
170°
 Reemplaza: 875787, 3831425



18-3662
KIT TERMOSTATO
145°
 Reemplaza: 875794, 876305



18-3663
KIT TERMOSTATO
130°
 Reemplaza: 875791



18-3664
KIT TERMOSTATO
165°
 Reemplaza: 875795



18-3665
KIT TERMOSTATO
140°
 Reemplaza: 875796

① **18-3666D** 



18-3666
KIT TERMOSTATO
(82°C)
 Reemplaza: 875580
180°



18-3615
TERMOSTATO - AGUA
 Reemplaza: 3587597
150°



18-3617
KIT TERMOSTATO



18-3620
KIT TERMOSTATO
180°



18-3621
KIT TERMOSTATO
160°



18-3626
KIT TERMOSTATO
145°



18-3618
KIT TERMOSTATO REFR.
AGUA
150°



18-3619
KIT TERMOSTATO-REFR.
AGUA DULCE
150°

SISTEMA DE REFRIGERACIÓN AGUA (ABIERTO)- EL AGUA (RIO, LAGO, MAR) CORRE A TRAVÉS DEL BLOQUE CILINDROS

Modelo	Version	Identificador	Año modelo	Termostato	Retén	Junta	Termostato y Kit retén	Kit Completo y junta de sellado
AQ90			1962-1964	NSS	18-2933		18-3656	
AQ95			1964-1968	NSS	18-2933		18-3656	
AQ100			1961-1963	NSS	18-2933		18-3656	
AQ130	A, B, C, D		1968-1977	NSS	18-2933		18-3656	
AQ115	A, B		1969-1975	NSS	18-2933		18-3656	
AQ140	A		1975-1979	NSS	18-2933	18-7181	18-3666	18-3620
AQ120	B		1977-1980	NSS	18-2933	18-7181	18-3666	18-3620
AQ145	A, B		1979-1985	NSS	18-2933	18-7181	18-3666	18-3620
AQ125	A, B		1981-1985	NSS	18-2933	18-7181	18-3666	18-3620
AQ131	A, B, C, D		1985-1989	NSS	18-2933	18-7181	18-3666	18-3620
230	A, B		1989-1993	NSS	18-2933	18-7181	18-3666	18-3620
AQ151	A, B, C		1985-1989	NSS	18-2933	18-7181	18-3666	18-3620
AQ171	A, C		1986-1989	NSS	18-2933	18-7181	18-3666	18-3620
250	A, B		1986-1993	NSS	18-2933	18-7181	18-3666	18-3620
251	A		1989-1992	NSS	18-2933	18-7181	18-3666	18-3620
3.0 GL, GS		MD,HU,NC	1993-1996	18-3558	18-0929	18-2858		18-3670
3.0 GL, GL, GSP, GLP, GLM		LK,BY,WT,EF	1996-2000	18-3558	NSS	18-0164		18-3621
3.0 GLP, GLM, GSP, GSM	A, B, C, D, E, J		2000-Actual	18-3558	NSS	18-0164		18-3621
3.0 GXi, 3.0GXiC	J		2009-Actual	18-3557	NSS	18-0164		18-3626
AQ175			1981-1985	18-3551	18-2933	18-0398		18-3662
AQ205	A		1988-1989	18-3551	18-2933	18-0398		18-3662
431	A, B		1989-1991	18-3551	18-2933	18-0398		18-3662
430	A, B		1990-1991	18-3551	18-2933	18-0398		18-3662
432	A		1992-1993	18-3551	18-2933	18-0398		18-3662
434	A		1992-1993	18-3551	18-2933	18-0398		18-3662
4.3 (Todos modelos)		MD,HU,NC,LK, BY,WT,EF	1993-2000	NSS	18-7170	18-2917		18-3677
4.3 (Todos modelos)	A, B		2001-2002	NSS	18-7170	18-2917		18-3677
4.3 (Todos modelos)	C, D, E, F, G, J		2002-Actual	NSS	NSS	18-2917	18-3615	18-3618
AQ190	A		1976-1977	18-3551		18-0398		18-3662
AQ200	B,C		1974-1976	18-3551		18-0398		18-3662
AQ225	B, C		1974-1976	18-3551		18-0398		18-3662
AQ200	D, F		1977-1986	18-3551		18-0398		18-3662
AQ225			1977-1986	18-3551	18-2933	18-0398		18-3662
AQ211	A		1986-1989	18-3551	18-2933	18-0398		18-3662
AQ231			1986-1989	18-3551	18-2933	18-0398		18-3662
500			1989-1993	18-3551	18-2933	18-0398		18-3662
501			1989-1993	18-3551	18-2933	18-0398		18-3662
5.0 FiP, FLP		MD,HU,NC	1993-1996	NSS	18-7170	18-2917		18-3677
5.0 GiP, GLP		BY,WT,EF	1997-2000	NSS	18-7170	18-2917		18-3677
5.0 GL, GXi, OSi	A, B		2001-2003	NSS	18-7170	18-2917		18-3677
5.0 (Todos modelos)	C, D, E, F, G, H, J, K		2002-Actual	NSS	NSS	18-2917	18-3615	18-3618
AQ271	A, B		1986	18-3551	18-2933	18-0398		18-3662
AQ260	A, B		1979-1985	18-3551	18-2933	18-0398		18-3662
AQ311	A		1986-1987	18-3551	18-2933	18-0398		18-3662
AQ271	C		1986-1989	18-3551	18-2933	18-0398		18-3662
AQ255	A, B		1977-1978			18-0398		
571	A		1989-1992	18-3551	18-2933	18-0398		18-3662
5.7 (Todos modelos)		MD, HU, NC, LK, BY, WT, EF	1993-2000	NSS	18-7170	18-2917		18-3677
5.7 (todos modelos excepto OSi)	A, B, C			2001-2003	NSS	18-7170	18-2917	18-3677
5.7 OSi, OSXi	B, C		2001-2003	NSS	NSS	18-2917	18-3615	18-3618
5.7 (Todos modelos)	D, E, F, G, H, J, K		2002-Current	NSS	NSS	18-2917	18-3615	18-3618
5.8 (Todos modelos)		HU, NC	1993-1996	NSS	18-7170	18-2917		18-3677
740	A, B		1991-1993	18-3551	18-2933	18-0398		18-3662
7.4 (Todos modelos)		MD, HU, NC, LK, BY, WT, EF	1993-2000	NSS	18-7170	18-2917		18-3676
8.1 (Todos modelos)			2000-Actual	NSS	18-7170	NSS		18-3617
8.2 (Todos modelos)		MD, HU, NC, LK, BY, WT, EF	1993-2000	NSS	18-7170	18-2917		18-3676

SISTEMA DE REFRIGERACIÓN AGUA DULCE (CERRADO) - MOTOR EQUIPADO CON DEPÓSITO ANTI-CONGELACIÓN

4.3, 5.0, 5.7 (Todos modelos)			1993 - Actual	NSS	18-2933	18-2917	18-3539	18-3619
5.8 (Todos modelos)			1993 - 1996	NSS	18-2933	18-2917	18-3539	18-3619
7.4 (Todos modelos)			1991 - 2000	NSS	18-2933	18-2917	18-3539	18-3619
8.1 (Todos modelos)			2000-Actual	NSS	18-2933	18-2917	18-3539	18-3619
8.2 (Todos modelos)			1993 - 2000	NSS	18-2933	18-2917	18-3539	18-3619



**18-1476
KIT ARBOL DE LEVAS**

Para: AQ165A, AQ170A, AQ170B, AQ170C, BB165A, BB170A, BB170B, BB170C



**18-1477
KIT ARBOL DE LEVAS**

Para: B18, B20, AQ60F, AQ90, AQ95, AQ110, AQ120, BB30, BB100, MB18, AQ105, AQ115A, AQ115B, AQ130A, AQ130B, AQ130C, AQ130D, BB115A, BB115B, BB115C, MB20A, MB20B, MB20C



**18-1478
ARBOL LEVAS**

Reemplaza: 1218674

Para: B18, B20, AQ60F, AQ90, AQ95, AQ95A, AQ110, AQ120, BB30, BB100, MB18, AQ105A, AQ115A, AQ115B, AQ130A, AQ130B, AQ130C, AQ130D, BB115A, BB115B, BB115C, MB20A, MB20B, MB20C



**18-1479
ARBOL DE LEVAS**

Reemplaza: 461511

Para: B30, AQ165A, AQ170A, AQ170B, AQ170C, BB165A, BB170A, BB170B, BB170C



VÁLVULA

Ref #	Tipo	O.E. #	Aplicación
18-4464	Escape	829620	D1, D2, D3, 3AA, D17, AQD2B, MD1B, MD2B, MD3B, MD11C, MD11D, MD17C, MD17D
18-4469	Escape	1542389	D40, AD40B, AQAD40A, AQAD40B, AQD40A, MD40A, TAMD40A, TAMD40B, TMD40A, TMD40B, TMD40C
18-4470	Escape	419735	B20, B30, AQ105A, AQ115A, AQ115B, AQ130A, AQ130B, AQ130C, AQ130D, BB115A, BB115B, BB115C, MB20A, MB20B, MB20C
18-4471	Escape	838638	D31, D32, D41, D42, D43, AD31L-A, AD31P-A, TAMD31L-A, TAMD31M-A, TAMD31P-A, TMD31L-A, KAD32PA, AD41L-A, AD41P-A, D41L-A, TAMD41H-A, TAMDS41L-A, TAMD41P-A, TMD41A, TMD41L-A, KAD42A, KAD42P-A, KAMD42A, KAMD42B, KAMD42P-A, TAMD42B, TAMD42WJ-A, KAD43P-A, KAMD43P-A
18-4463	Admis.	833188	D1, D2, D3, 3AA, D17, AQD2B, MD1B, MD2B, MD3B, MD11C, MD11D, MD17C, MD17D
18-4466	Admis.	838637	D31, D32, D41, D42, D43, AD31L-A, AD31P-A, TAMD31L-A, TAMD31M-A, TAMD31P-A, TMD31L-A, KAD32PA, AD41L-A, AD41P-A, D41L-A, TAMD41H-A, TAMDS41L-A, TAMD41P-A, TMD41A, TMD41L-A, KAD42A, KAD42P-A, KAMD42A, KAMD42B, KAMD42P-A, TAMD42B, TAMD42WJ-A, KAD43P-A, KAMD43P-A
18-4467	Admis.	1542472	D40, AD40B, AQAD40A, AQAD40B, AQD40A, MD40A, TAMD40A, TAMD40B, TMD40A, TMD40B, TMD40C
18-4468	Admis.	419734	B20, B30, AQ105A, AQ115A, AQ115B, AQ130A, AQ130B, AQ130C, AQ130D, BB115A, BB115B, BB115C, MB20A, MB20B, MB20C



**18-4465
VÁLVULA
GUÍA**

Reemplaza: 3582609

Para escape, 230, 250, AQ115, BB115, MB20, AQ130, AQ165, BB165, AQ170, BB170, AQD21A, MD21A, AQ120B, AQ125A, AQ140A, BB140A, AQ125B, AQ131A, AQ131B, AQ131C, AQ131D, AQ145A, BB145A, AQ145B, AQ151A, AQ151B, AQ151C, MB10



**18-4472
ELEV.
VÁLVULA**

Reemplaza: 1218630

Para: B18, B20, B30, AQ120, AQ90, AQ95, AQ110, AQ120, BB30, BB100, MB18, AQ105A, AQ115A, AQ115B, AQ130A, AQ130B, AQ130C, AQ130D, BB115A, BB115B, BB115C, MB20A, MB20B, MB20C, AQ165A, AQ170A, AQ170C, BB165A, BB170A, BB170B, BB170C



**18-4473
VÁLVULA GUÍA**

Reemplaza: 419653, 3582561

Para: AQ115, BB115, MB20, AQ130, AQ165, AQ170, BB170, AQD21A, MD21A, KAMD42A, KA-D42A, KAMD42P, KAD42P, MD11, MD17, MD1B, MD2B, MD3B, MD30, TMD30, TAMD30, AQAD30, MD31A, TMD31B, TAMD40, AQAD40, TAMD42B, KAMD42B, KAD42B, TMD31D, TAMD31D, AD31XD, TMD41B, TAMD41B, D41B, TMD41D, TAMD41D, D41D, AD41D



**18-4474
VÁLVULA
GUÍA**

Reemplaza: 419652, 3582606

Para admisión: Para: 230, 250, AQ115, BB115, MB20, AQ130, AQ165, BB165, AQ170, BB170, AQD21A, MD21A, AQ120B, AQ125A, AQ140A, BB140A, AQ125B, AQ131A, AQ131B, AQ131C, AQ131D, AQ145A, BB145A, AQ145B, AQ151A, AQ151B, AQ151C, MB10



**18-4029
CORREA DISTRIBUCIÓN**

Reemplaza: 463377

AQ120B, 125A,B, 131A,B,C,D 140, 145, 151A,B,C, 230, 250, BB140A, 145A,B 4 Cil.



**18-4044
CORREA**

Reemplaza: 834548, 966694-2

Generador: AQ120B, 125A, 140A, 145A, 165, 170A, B, C

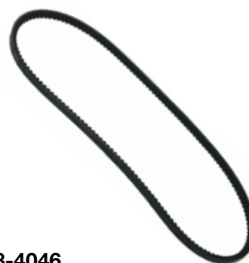

**18-4046
CORREA**

Reemplaza: 958498, 966857

Generador: AQ175A, 200A, B, C, D, 225A,B, 260A, B, 280A, 290A
Bomba agua AQ210
V-6, V-8



**18-8964
POLEA BOMBA DIRECCIÓN**

Reemplaza: 3853804

Para: Mayoría aplicaciones Volvo stern-drive



TAPONES EXPANSIÓN

Ref #	Env	O.E. #	Medida
18-4200 ① ②	5	477024	35MM (1.375")
18-4201 ① ②	5	192212	45MM (1.770")
18-4245 ②	5	463902	42MM (1.655")
18-4246 ②	5	463903-5	35MM (1.375")
18-4247 ②	5	463904	45MM (1.770")

① Acero inox.
② Este precio es precio por pieza. Para pedir envasado añadir 9 a la referencia.



**18-2367
TUERCA CABEZA CILINDRO**
Reemplaza: 943414
Para cabeza cilindro: Para: D1, D2, D3, D11, D17, MD1B, AQD2B, MD2B, MD11C, MD11D, MD3B, MD17C, MD17D

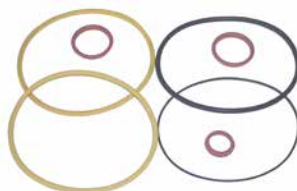

**18-2793
KIT RETENES**
Reemplaza: 875550
Para cilindros en línea: Para: D11, D17, MD11C, MD11D, MD17C, MD17D:
NOTA: Modelo MD11 requiere dos
18-2793 y Modelo MD17 requiere tres
18-2793



**18-1727
SILENTBLOCK**
Reemplaza: 803762
Acoplador de eje propulsor:
Para: B18, B20, B30, MB10, 2001, 2002, 2003, 2010, 2020, 2030, 2040, D1, D2, D3, D5, D6, D7, D11, D17, D21, D22, D29, D32, BB30, BB100, BB115, BB165, BB170, MB10A, MB18, MB20, MD1, MD2, MD3, MD5, MD6, MD7, MD11, MD17, MD21, MD22, MD29, MD32



**18-4005
SILENTBLOCK**
Reemplaza: 833950
Para: D5, D6, D7, D11, D17, MB10, MB10A, MD5A, MD5B, MD5C, MD6A, MD6B, MD7A, MD7B, MD11C, MD11D, MD17C, MD17D



**18-57702
FILTRO**
Reemplaza: 876069
Para: Volvo MD30A, TMD30A, TAMD30A, MD31A, TMD31A, TAMD31A, MD40A, TMD40A, TMD40B, TAMD40A, TAMD40B, TMD41A, TAMD41A



**18-7907
FILTRO AIRE**
Reemplaza: 858488
Para: D31, D41, D42, AD31A, AD31B, AD31D, AD31L-A, AD31P-A, AD31XD, AQAD31A, MD31A, TAMD31A, TAMD31B, TAMD31D, TAMD31L-A, TAMD31M-A, TAMD31P-A, TMD31A, TMD31B, TMD31D, TMD31L-A, AD41A, AD41B, AD41D, AD41L-A, AD41P-A, AQAD41A, D41A, D41B, D41D, D41L-A, TAMD41A, TAMD41B, TAMD41D, TAMD41H-A, TAMD41L-A, TAMD41M-A, TAMD41P-A, TMD41A, TMD41B, TMD41D, TMD41L-A, TAMD42B, TAMD42WJ-A



**18-7908
FILTRO AIRE**
Reemplaza: 3582358
Para: D31, D41, AD31A, AD31B, AD31D, AD31L-A, AD31P-A, AD31XD, AQAD31A, TAMD31A, TAMD31B, TAMD31D, TAMD31L-A, TAMD31M-A, TAMD31P-A, TMD31A, TMD31B, TMD31D, TMD31L-A, AD41D, AD41L-A, AD41P-A, AQAD41A, AQD41A, D41A, D41B, D41D, D41L-A, TAMD41A, TAMD41B, TAMD41D, TAMD41H-A, TAMD41L-A, TAMD41M-A, TAMD41P-A, TMD41A, TMD41B, TMD41D, TMD41L-A, TMD41D, TMD41L-A



**18-7890
FILTRO AIRE**
Reemplaza:
463505, 876185
MD30, MD40, KAD42A, KAMD42A
Diesel



**18-0035
FILTRO ACEITE DIESEL, FLUJO COMPLETO**
Reemplaza: 3582732
Para: D4-180i-B, D4-180i-C, D4-210A-A, D4-210A-B, D4-210i-A, D4-210i-B, D4-225A-B, D4-225A-C, D4-225i-B, D4-225i-C, D4-260A-A, D4-260A-B, D4-260A-C, D4-260D-B, D4-260D-C, D4-260i-A, D4-260i-B, D4-260i-C, D4-300A-A, D4-300A-C, D4-300D-A, D4-300D-C, D4-300i-A, D4-300i-C, D6-280A-A, D6-280A-B, D6-280i-A, D6-280i-B, D6-310A-A, D6-310A-B, D6-310D-A, D6-310D-B, D6-310i-A, D6-310i-B, D6-330A-B, D6-330A-C, D6-330D-B, D6-330D-C, D6-330i-B, D6-330i-C, D6-350A-A, D6-350A-B, D6-370A-B, D6-370A-C, D6-370D-A, D6-370D-B, D6-370D-C, D6-370i-A, D6-370i-B, D6-370i-C, D6-435D-A, D6-435D-C, D6-435i-A, D6-435i-C



**18-0036
FILTRO ACEITE DIESEL**
Reemplaza: 3582733
Para: D4-180i-B, D4-180i-C, D4-210A-A, D4-210A-B, D4-210i-A, D4-210i-B, D4-225A-B, D4-225A-C, D4-225i-B, D4-225i-C, D4-260A-A, D4-260A-B, D4-260A-C, D4-260D-B, D4-260D-C, D4-260i-A, D4-260i-B, D4-260i-C, D4-300A-A, D4-300A-C, D4-300D-A, D4-300D-C, D4-300i-A, D4-300i-C, D6-280A-A, D6-280A-B, D6-280i-A, D6-280i-B, D6-310A-A, D6-310A-B, D6-310D-A, D6-310D-B, D6-310i-A, D6-310i-B, D6-330A-B, D6-330A-C, D6-330D-B, D6-330D-C, D6-330i-B, D6-330i-C, D6-350A-A, D6-350A-B, D6-370A-B, D6-370A-C, D6-370D-A, D6-370D-B, D6-370D-C, D6-370i-A, D6-370i-B, D6-370i-C, D6-435D-A, D6-435D-C, D6-435i-A, D6-435i-C



FILTROS ACEITE

Ref #	O.E. #	Aplicación
18-8003	8692305	—
18-7824-1	835440	Filtro corto GM
18-7876	3850559	Filtro largo GM
18-7878-1	430143, 1266286, 3517857	Filtro corto Ford
18-7879-1	841750	V-6 GM

FILTRO ACEITE DIESEL		
Ref #	O.E. #	Aplicación
18-0032	847741	—
18-0033	478436	—
18-0034	477556	—
18-7880	466634	TAMD100, TMD102, TMD121, TMD122, TAMD122 & TAMD162
18-7884	834337	—
18-7974	3827069	—



**18-7974
FILTRO ACEITE**
Reemplaza: 3827069
Rosca: 18mm x 1.5
Para: Diesel Modelos AQD21A-B, AQD32A, MD21A/B, MD32A, TAMD61A, TAMD62A, TAMD63L-A, TAMD63P-A, TAMD71A/B, TAMD72A, TAMD73P-A, TAMD73WJ-A, TAMD74A-A, TAMD74A-B, TAMD74C-A, TAMD74C-B, TAMD74P-B, TAMD75P-A

CULATAS

Todas las culatas son nuevas y montadas con válvulas de acero inoxidable, asientos de válvula de acero templado, muelles de válvula, semi-conos, y retenes.

Todas las culatas GM utilizan esparragos de alto rendimiento en lugar de los originales.



18-4485

CULATA

Para: 5.7L V-8 GM (1987-95) con 12 pernos en el colector admisión- (4 tornillos colector entrada a 23 grados), tapa válvulas en el centro



18-4486

CULATA

Para: 5.7L V-8 GM Vortec (1996-Sup) con 8 pernos en el colector de admisión, Para tapa de válvula con tornillos en el dentro



18-4486HP

CULATA

Para: Vortec GM bloque pequeño 5.7L alto rendimiento
Completamente ensamblada con carreras y camaras de combustión revisadas. Añade 30hp. de potencia sin modificaciones

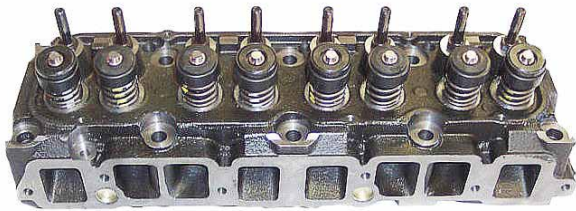

18-4489

CULATA

Para: 2.5L/3.0L GM (1968-95) (no para modelos MerCruiser LX) (1968-95)



18-4491

CULATA

Reemplaza 4.3L Vortec V-6 (1996-sup) 8 tornillos en el colector de admisión, tapa válvula montaje central.



18-4501

CULATA

Para: 5.0L Vortec



18-4501HP

CULATA

Para: Vortec GM bloque pequeño 5.0L
Completamente ensamblada con carreras y camaras de combustión revisadas. Añade 30 hp de potencia sin modificaciones.





18-1400
LEVA HIDRÁLICA
 Reemplaza: 3856127
 GM 4.3L/V-6 último/5.0L/5.7L



18-1401
LEVA HIDRÁLICA
 Reemplaza: 3853847, 985316
 Ford 302/351
 Ford 5.0L & 5.8L



18-1402
LEVA HIDRÁLICA
 Reemplaza: 3854033, 502036
 GM 2.5L/120
 Para: Volvo 3.0L/181 CID GM 3.0L, 4.3L, 5.0L & 5.7L

**TODOS LOS PISTONES
 SE SUMINISTRAN COMPLETOS CON ARO Y PASADOR.**



PISTONES	
STD	OMC / VOLVO #
18-4161	3853340, 914816
18-4173	*14077948
18-4173	3911020
0.02	
18-4160	3853477, 915236
0.03	
18-4164	*14077949, 3911023
* OMC Referencias GM Número	

AROS	
STD	OMC / VOLVO #
18-3937	*14089025
18-3937	328506
18-3937	3853960
18-3937	914555
18-3937	3853268
18-3937	985083, 986336
-	328536
18-3944	370409

AROS	
0.02	
18-3939	3854252
18-3939	914556
0.03	
18-3938	*14089026
18-3938	328516
18-3938	914557

APLICACIÓN PISTON / ARO

VOLVO	PISTONES			AROS			Cant. motor.		
	Modelo	Número serie	Std.	.020	.030	Std.		.020	Per .030
GM									
2.5L/153 CID			18-4180	18-4183	-	18-3942	-	-	4
3.0L/181 CID			18-4161	18-4160	18-4191	18-3937	18-3939	18-3938	4
4.3L/V-6			18-4173	18-4188	18-4164	18-3937	18-3939	18-3938	6
5.0L/305 CID			-	-	18-4178	18-3944	-	-	8
5.7L/350 CID			18-4173	18-4188	18-4164	18-3937	18-3939	18-3938	8
7.4L/454 CID			18-4171	18-4189	18-4172	18-3940	-	-	8
FORD									
5.0L/302 CID			-	-	-	18-3937	18-3939	18-3938	8



COJINETE BIELA

Ref #	Medida
18-1308	Std.
18-1309	.010
18-1327	Std.
18-1332	.020
18-1333	.010
18-1334	Std.
18-1337	.010
18-1341	.020

Se venden individualmente,
1 por biela.



COJINETE CIGÜEÑAL

Ref #	Por motor	Medida
18-1300	②	Std.
18-1311	②	Std.
18-1315	②	Std.
18-1316	②	.010
18-1317	②	Std.

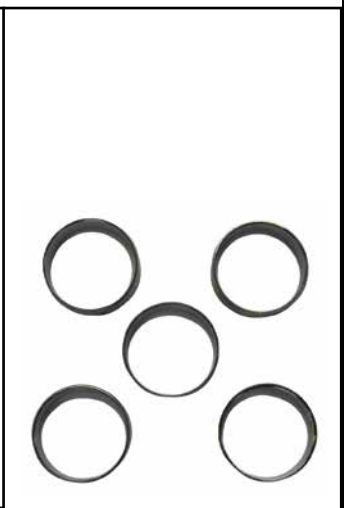

COJINETE LEVA

Ref #	Por motor.
18-1339	1 ②

APLICACIÓN COJINETE

Modelo	COJINETE BIELA			COJINETE BIELA			COJINETE LEVA
	Std.	.010	.020	Std.	.010	.020	

VOLVO

GM

3.0L/181 CID	18-1308	18-1309	18-1341	18-1317	18-1316	-	18-1339
4.3L/V-6	18-1327	18-1337	-	18-1311	-	-	-
5.0L/305 CID	18-1308	18-1309	18-1341	18-1300	-	-	-
5.7L/350 CID	18-1308	18-1309	18-1341	18-1300	-	-	-
7.4L/454 CID	18-1334	18-1333	18-1332	18-1315	-	-	-

FORD

5.0L/302 CID	-	-	-	-	-	-	-
--------------	---	---	---	---	---	---	---

**18-0518
RETÉN VÁLVULA**
Reemplaza: 3854956,
914323, 3853132
Para: mayoría de 4 y 6 cil. GM (Primeros)
y 305-350 CID GM

PACK. DE 8

**18-4024
18-4024-9①
RETÉN VÁLVULA**
Reemplaza:
3853226, 914445
Para: Chevy 4.3L/5.0L/5.7L

**18-4031
RETÉN VÁLVULA**
Reemplaza: 1306630
AQ120B, 125A, B, 131A, 140A, 145A, B,
151A, B, MD1B, 2B, 3B, 5A, 2001, 2002, 2003,
MD5B, C, 11C, D, 17C, D, 30, 31, 40, 41

**18-1234
RETÉN CIGÜEÑAL**
Reemplaza: 3853528
Para: 7.4L, GL, G, GSI: 8.2L, GL
18-0519
Reemplaza: 3852657, 912957
4.3L/3.0L/5.0L 5.7L

RETENES CIGÜEÑAL
18-0528
Reemplaza:
3852805

18-1211

RETÉN CIGÜEÑAL
18-1213
Reemplaza:
3853341

① Precio por pack

② Juego motor completo

APLICACIÓN RETÉN VOLVO

Modelo motor	2 retén principal del cigüeñal Conv. Rotación (LH)	Retén tapa Distribución
GM		
3.0L/181 CID	18-1211 ②	18-1213
4.3L/V-6	18-1211 ②	18-1213
5.0L/305 CID	18-1211 ①	18-1213
5.7L/350 CID	18-1211 ①	18-1213
7.4L/454 CID	③	18-1233
FORD		
5.0L/302 CID	18-0528	18-1230
5.8L/351 CID	—	18-1230

① Cigüeñal largo motores GM ② Para retenes de una sola pieza (LH) usar 18-0519 ③ Para retenes de una sola pieza (LH) usar PAR 18-1234

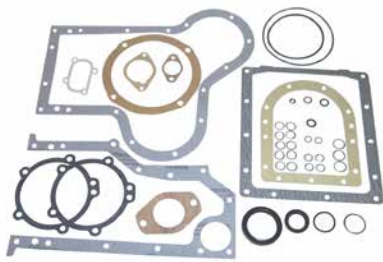

18-0252
JUEGO JUNTAS CONVERSIÓN
Reemplaza: 876314
Para: D6, D7, MD6A, MD6B, MD7A, MD7B

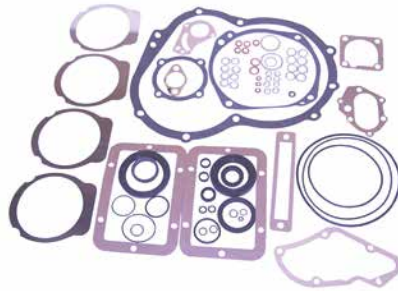

18-0489
JUEGO JUNTAS CONVERSIÓN
Reemplaza: 876384
Para: D11, MD11C, MD11D

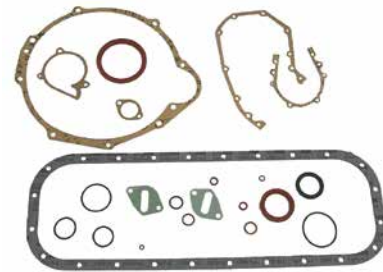

18-2814
JUEGO JUNTAS BLOQUE CORTO
Reemplaza: 876306
(6 CIL.)

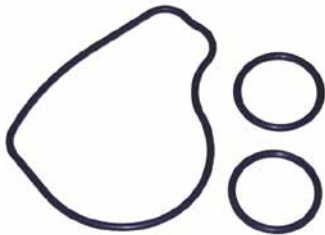

18-2699
JUEGO DE JUNTAS
Para: Colas SX y DP-SM hasta 2006

Ref #	Descripción	O.E. #	Cant.
18-7153	Aro tórico	911851	2
18-2996	Junta	911823	1



18-2596
KIT JUNTAS CULATA
Reemplaza: 875422
Para: D1, D2, D1A, MD1A, D2A, MD2, MD2A:
NOTA: Modelo MD2A requiere dos 18-2596

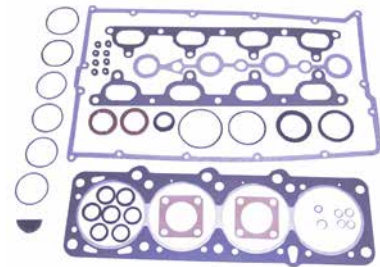

18-3870
KIT JUNTAS CULATA
Reemplaza: 876303
Para: B25, 251A, AQ171A, AQ171C

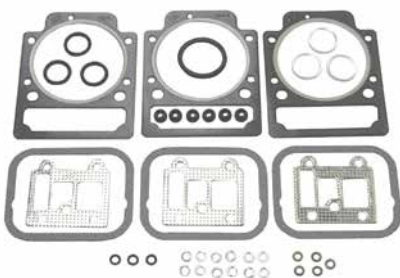

18-4341
KIT JUNTAS CULATA
Reemplaza: 876380
Para: D17, MD17C, MD17D



18-4342
KIT JUNTAS CULATA
Reemplaza: 876376
Para: D11, MD11C, MD11D



18-2813
KIT JUNTAS CULATA
Reemplaza: 876302
(4 CIL.)

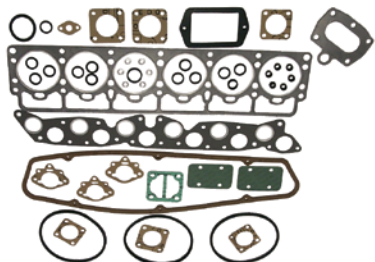

18-2816
KIT JUNTAS CULATA
 Reemplaza: 876337
 (6 CIL.)

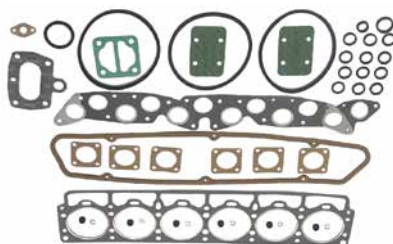

18-2817
KIT JUNTAS CULATA
 Reemplaza: 876359
 (6 CIL.)



18-2818
KIT JUNTAS CARTER
 Reemplaza: 876433
 (4 CIL.)



18-2980
KIT JUNTAS CULATA
 Reemplaza: 875401 (antiguo), 876356
 (4 CIL.)



18-2982
KIT JUNTAS CULATA
 Reemplaza: 875569 (antiguo), 876358
 (4 CIL.)



18-2983
KIT JUNTAS CARTER
 Reemplaza: 875400 (antiguo), 876342
 (4 CIL.)



18-2998
KIT JUNTAS CULATA
 Reemplaza: 876300
 (4 CIL.)



18-0410
KIT JUNTAS COLECTOR ADMISIÓN
 Reemplaza: 3853912, 3853913, 3854406
 Para: Volvo 5.0L FL, FI, 5.8L FL, FI, FSI



18-0868
KIT JUNTAS COLECTOR ADMISIÓN
 Reemplaza: 3854269



18-1238
KIT JUNTAS ADMISIÓN
 Reemplaza: 3850379, 912979
 Para: Volvo 4.3GL/GS 1994-96, 4.3Gi 1995-97



18-0498
JUNTA CULATA
 Reemplaza: 3580309
 Para: MD2030A, MD2030B



18-2811
JUNTA CULATA
 Reemplaza: 461618
 (6 CIL.)















18-2946
JUNTA CULATA
 Reemplaza: 3853336, 908611
 Para: motor GM 181 (3.0L) CID .

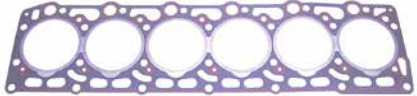

18-2965
JUNTA CULATA
 Reemplaza: 419310, 419763-8
 (4 CIL.)









































18-2966
JUNTA CULATA
 Reemplaza: 462623
 (4 CIL.)

 <p>18-2968 JUNTA CULATA Reemplaza: 1378645 (4 CIL.)</p>	 <p>18-2970 JUNTA CULATA Reemplaza: 1378646 (4 CIL.)</p>	 <p>18-3834 JUNTA CULATA Reemplaza: 833453</p>	
 <p>18-3842 JUNTA CULATA Reemplaza: 833274 Para:D1,D2, MD1A, MD2A</p>	 <p>18-3843 JUNTA CULATA Reemplaza: 859155 Para:D40, AD40B, AQAD40A, AQAD40B, AQD40A, MD40A, TAMD40A, TAMD40B, TMD40B, TMD40C</p>	 <p>18-3867 JUNTA CULATA Reemplaza: 859647 Para:MD22A, MD22L-A, MD22L-B, MD22P-B, TAMD22P-B, TMD22A, TMD22B</p>	
 <p>18-3868 JUNTA CULATA Reemplaza: 3583786 Para:D41, D42, D43, D44, AD41A, AD41B, AD41D, AD41L-A, AD41P-A, AQAD41A, D41A, D41B, D41D, D41L-A, TAMD41A, TAMD41B, TAMD41D, TAMD41H-A, TAMD41L-A, TAMD41M-A, TAMD41P-A, TMD41A, TMD41B, TMD41D, TMD41LA, KAD42A, KAD42B, KAD42P-A, KAMD42A, KAMD42B, KAMD42P-A, TAMD42B, TAMD42WJ-A, KAD43P-A, KAMD43P-A, KAD44P-A, KAD44P-B, KAD44P-C, KAMD44P-A, KAMD44P-B, KAMD44P-C</p>		 <p>18-3873 JUNTA CULATA Reemplaza: 3853587 Para:7.4L GL, GI, GSI, 8.2L GL</p>	 <p>18-3869 JUNTA CULATA Reemplaza: 3584202 Para:MD2040A, MD2040B</p>
 <p>18-3876 JUNTA CULATA Reemplaza: 841207-4, 856474-2 Para: GM 305 (motor 5.0L)/350 (5.7L) CID.</p>	 <p>18-3879 JUNTA CULATA Reemplaza: 3854299, 912227, 914930 Para: motor GM 262 (4.3L) CID.</p>	 <p>18-3883 JUNTA CULATA Reemplaza: 3853732 Para: motor Ford 302 (5.0L) 351 (5.8L) CID.</p>	 <p>18-3887 JUNTA CULATA Reemplaza: 3853511 Para: Volvo 7.4L</p>

APLICACIONES KIT JUNTA CULATA/KIT JUNTAS/JUNTA CULATA

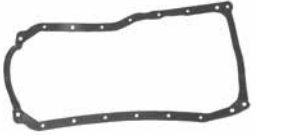
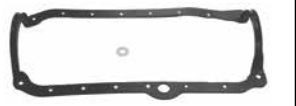
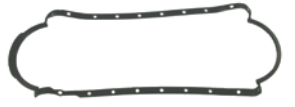
Modelo	Kit junta culata	Kit junta	Junta Culata	Modelo	Kit Junta culata	Kit Junta	Junta Culata	Modelo	Kit junta culata	Kit Junta	Junta Culata
AQ60	—	18-2983	—	AQ140A	18-2998	18-2818	18-2968	BB115C	—	—	18-2966
AQ90	—	18-2983	—	AQ145A	—	18-2818	18-2970	BB140A	18-2998	18-2818	18-2968
AQ95	—	18-2983	—	AQ145B	18-2813	—	18-2970	BB145A	18-2999	18-2818	—
AQ100	—	18-2983	—	AQ151A,B,C	18-2813	—	18-2970	BB165	—	18-2814	—
AQ105	—	18-2983	—	AQ165	—	18-2814	—	BB170C	18-2817	18-2814	18-2811
AQ110	—	18-2983	—	AQ170A	—	18-2814	—	BB30	—	18-2983	—
AQ115	—	18-2983	—	AQ170B	18-2816	18-2814	—	MB18	—	18-2983	—
AQ115A	18-2980	—	18-2965	AQ170C	18-2817	18-2814	18-2811	MB20	—	18-2983	—
AQ115B,C	—	18-2982	18-2966	AQD2B	18-2985	—	18-3833	MB20A	18-2981	—	—
AQ120A	—	18-2983	—	B20 (0.8MM)	—	—	18-2965	MB20B	18-2980	—	18-2965
AQ120B	18-2998	18-2818	18-2968	B20 (1.2MM)	—	—	18-2966	MB20C	18-2982	—	18-2966
AQ125A	18-2998	18-2818	18-2968	B21	—	—	18-2968	MD11C,D	—	—	18-3834
AQ125B	18-2813	—	18-2970	B23	—	—	18-2970	MD17C,D	—	—	18-3834
AQ130	—	18-2983	—	B30 (0.8MM)	—	—	—	MD1B	—	—	—
AQ130A	18-2980	—	18-2965	B30 (1.2MM)	—	—	18-2811	MD2B	18-2985	—	—
AQ130B	—	—	—	BB30	—	18-2983	—	MD3B	—	—	—
AQ130C	18-2980	—	18-2965	BB100	—	18-2983	—	230A,B	18-2813	—	—
AQ130D	18-2982	—	18-2966	BB115A,B	—	—	—	250A,B	18-2813	—	—
AQ131A,B,C,D	18-2813	—	18-2970								















<p>Pack. de 2</p>  <p>18-0876 18-0876-9① JUNTA BOMBA COMBUSTIBLE Para GM 4.3L, 5.0L & 5.7L Reemplaza: 3852113</p>	<p>Pack. de 2</p>  <p>18-0889 18-0889-9① JUNTA BOMBA COMBUSTIBLE Para GM 4.3L, 5.0L & 5.7L Reemplaza: 3852095</p>	<p>Pack. de 2</p>  <p>18-2989 18-2989-9① JUNTA MONTAJE CARBURADOR Reemplaza: 824677 AQ115, 125A, B, 130C, D, 131A, 145A, B, 151A, B, 170, 171A</p>	<p>Pack. de 2</p>  <p>18-0398 18-0398-9① JUNTA TERMSOTATO Reemplaza: 835417</p>
<p>Pack. de 2</p>  <p>18-2933 18-2933-9① JUNTA TERMOSTATO Reemplaza: 416033, 1317466 Usar con mayoría termostato Volvo (Excepto AQ175, V-8, MD1A)</p>	<p>Pack. de 2</p>  <p>18-2858 18-2858-9① JUNTA ALOJAMIENTO TAPA TERMOSTATO Reemplaza: 3852127 Para: 3.0L GS, GL, GLM, GLP, GSM, GSP</p>	<p>Pack. de 2</p>  <p>18-0164 18-0164-9① JUNTA ALOJAMIENTO TER- MOSTATO Reemplaza: 3852096 Para: 3.0L GS, GL</p>	<p>Pack. de 2</p>  <p>18-0929 18-0929-9① JUNTA TERMOSTATO Para: 3.0L GS, GL</p>
 <p>18-0183-1 JUNTA COLECTOR ESCAPE Reemplaza: 3853742, 3852455</p>	 <p>18-0680 JUNTA COLECTOR ESCAPE Reemplaza: 3853256</p>	 <p>18-0418 JUNTA COLECTOR ESCAPE Reemplaza: 3852472 Para: Volvo 7.4L GL, GI, GSI, 8.2L GL, GI, GSI</p>	<p>Pack. de 2</p>  <p>18-2909 18-2909-9① JUNTA COLECTOR ESCAPE Reemplaza: 856116, 3853412 Para: Volvo 4.3GL, GS, GI, GXI, OSI</p>
 <p>18-2971-1 JUNTA COLECTOR ESCAPE Reemplaza: 856039, 835908 AQ200, 225, 260, 271, 290, 311</p>	 <p>18-2925 JUNTA COLECTOR ESCAPE Reemplaza: 461092 (antiguo), 1378913 AQ165, 170B, BB165, 170 6 Cil.</p>	 <p>18-2922 JUNTA COLECTOR ESCAPE Reemplaza: 418870 (antiguo), 1378911 AQ90, 95, 100, 105, 110, 115, 120, 120A, 130, BB30, 100, 115, MB18, 20 4Cil.</p>	 <p>18-2815 JUNTA TAPA VÁLVULAS Reemplaza: 3852692 Para: 3.0L</p>
 <p>18-1231 JUNTA ADMISIÓN Reemplaza: 3854095 Para: Volvo 7.4L GL, GI, GSI, 8.2L GL</p>	<p>Pack. de 2</p>  <p>18-2995 18-2995-9① JUNTA INTERCAMBIADOR CALOR Reemplaza: 856037 AQ120B, 125A, B, 140A, 145A,B</p>	 <p>18-2928 JUNTA COLECTOR ESCAPE Reemplaza: 824633, 856044 AQ105, 115, 130, BB115, MB20 4 Cil.</p>	 <p>18-2930 JUNTA COLECTOR ESCAPE Reemplaza: 1266796 (antiguo), 1378879 AQ125A, B, 145A, B, 131A, 151A, B, 120B, 140A</p>

<p>Pack. de 2</p>  <p>18-2949 18-2949-9^① JUNTA COLECTOR ESCAPE Reemplaza: 835966, 856034 AQ200, 225, 260, 271, 290, 311 V-8</p>	<p>Pack. de 4</p>  <p>18-2991-1 18-2991-9^① JUNTA COLECTOR ESCAPE Reemplaza: 855967, 855383 AQ120B, 125A, B, 131, 140, 145, 151, B21, B23</p>	 <p>18-0311 JUNTA TAPA VÁLVULA Reemplaza: 3854942 Para: 4.3 Litro 262 CID</p>	 <p>18-0664 JUNTA TAPA VÁLVULA Reemplaza: 3852687 Para: GM 305/350, 5.0 & 5.7L</p>
 <p>18-0347 JUNTA TAPA VÁLVULA Reemplaza: 3852693 Para: GM 153 & 181 CID (2.5L & 3.0L)</p>	 <p>18-0352 JUNTA TAPA VÁLVULA Reemplaza: 3852818 Para: Ford 302/351 CID (5.0L & 5.8L)</p>	 <p>18-2923 JUNTA TAPA VÁLVULA Reemplaza: 419678 AQ105, 115, 120, 130, BB115, MB20 4 Cil.</p>	 <p>18-2924 JUNTA TAPA VÁLVULA Reemplaza: 430039 AQ165, 170, BB165, 170 6 Cil.</p>
 <p>18-2927 JUNTA TAPA VÁLVULA Reemplaza: 463999 (antigua), 1378909 AQ120B, 125A, 140A, 145A, BB140, 145A 4Cil.</p>	 <p>18-2972 JUNTA TAPA VÁLVULA Reemplaza: 1378870 AQ125B, 145B, 131A, 151A, B</p>	 <p>18-2926 JUNTA CARTER Reemplaza: 463587 (antigua), 1378864 AQ90, 95, 100, 105, 110, 115, 120, 120B, 125A, B, 130, 131A, 140A, 145A, B, 151A, B, 171A</p>	 <p>18-0307 JUNTA CARTER Reemplaza: 861250 Para: D30, D31, D32, AD300A, AQAD30A, MD30A, TAMD30A, TMD30A, AD31A, AD31B, AD31D, AD31L-A, AD31P-A, AD31XD, AQAD31A, MD31A, TAMD31A, TAMD31B, TAMD31D, TAMD31L-A, TAM- D31M-A, TAMD31P-A, TMD31A, TMD31B, TMD31D, TMD31L-A, KAD32P-A</p>
 <p>18-0310 JUNTA CARTER Reemplaza: 861251 Para: D40, D41, D42, D43, D44, D300, AD40A, AQAD40A, AQAD40B, AQD40A, MD40A, TAMD40A, TAMD40B, TMD40A, TMD40B, TMD40C, AD41A, AD41B, AD41D, AD41L-A, AD41P-A, AQAD41A, D41A, D41B, D41D, D41L-A, TAMD41A, TAMD41B, TAMD41D, TAMD41H-A, TAMD41L-A, TAMD41M-A, TAMD41P-A, TMD41A, TMD41B, TMD41D, TMD41L-A, KAD42A, KAD42B, KAD42P-A, KAMD42A, KAMD42B, KAMD42P-A, TAMD42B, TAMD42WJ-A, KAD43P-A, KAMD43P-A, KAD44P-A, KAD44P-B, KAD44P-C, KAMD44P-C, KAMD44P-B, KAMD44P-C, KAD300, KAMD300A</p>	 <p>18-1237 JUNTA CARTER Reemplaza: 3856138 Para: GM 5.7L</p>	 <p>18-1239 JUNTA CARTER Reemplaza: 3853343 Para: Volvo 3.0L</p>	 <p>18-0405 JUNTA CARTER Reemplaza: 3852655 Para: Volvo 4.3L</p>
 <p>18-1232 JUNTA CARTER Reemplaza: 3853510 Para: Volvo 7.4L GL, GI, GSI, 8.2L GL</p>	 <p>18-0903 JUNTA BOMBA AGUA Reemplaza: 3853361 454 CID</p>	 <p>18-0327 JUNTA BOMBA AGUA Reemplaza: 3853342 4 & 6 Cil.</p>	<p>Pack. de 2</p>  <p>18-0891 18-0891-9^① JUNTA BOMBA AGUA Reemplaza: 3852477 Para: GM 4.3L, 5.0L & 5.8L</p>

① Precio por pack

<p>Pack. de 2</p>  <p>18-0893 18-0893-9① JUNTA BOMBA AGUA Reemplaza: 3850595 GM 4.3L, 5.0L & 5.7L</p>	 <p>18-0147 JUNTA BOMBA AGUA Para Ford V-8 Reemplaza: 3852824</p>	<p>Pack. de 2</p>  <p>18-2979-9① JUNTA BOMBA AGUA Reemplaza: 1378906 AQ120B, 125A, 140A, 145A</p>	
 <p>18-0468 JUNTA TAPA DISTRIBUCIÓN Reemplaza: 3852654, 3853512 GM 4.3L, 5.0L & 5.7L</p>	<p>PKG. OF 2</p>  <p>18-0887 18-0887-9① JUNTA TAPA DISTRIBUCIÓN Reemplaza: 3852691 4 & 6 Cil.</p>	 <p>18-25250 ARO SELLADO Reemplaza: 3863085 Para: Volvo SX-A/DPS-A (2007 & sup)</p>	 <p>18-25251 ARO SELLADO Reemplaza: 853868 Para: Volvo SX hasta 2006</p>
<p>Pack. de 2</p>  <p>18-2519 18-2519-9① ARO SELLANTE Reemplaza: 831622 Para pipeta refrigeración agua 120B, 125A, B, 131A, 140A, 145A, B, 151A, B, 171A</p>	<p>Pack. de 5</p>  <p>18-2525 18-2525-9① ARO SELLANTE Reemplaza: 430018 Bomba circulación culata AQ165A, 170A, B, C</p>	<p>Pack. de 5</p>  <p>18-2526 18-2526-9① ARO SELLANTE Reemplaza: 430172 Bomba circulación culata AQ165A, 170A, B, C</p>	<p>Pack. de 5</p>  <p>18-2527 18-2527-9① ARO SELLANTE Reemplaza: 831617 Para pipeta refrigeración agua AQ165A, 170A, B, C, MD21A (S/N MD-103387 & UP), MD21B</p>
<p>Pack. de 5</p>  <p>18-2528 18-2528-9① ARO SOPORTE Reemplaza: 831891 AQ120B, 125A, B, 140A, 145A, B</p>	<p>Pack. de 5</p>  <p>18-2529 18-2529-9① ARO SELLADO Reemplaza: 831892 AQ120B, 125A, B, 140A, 145A, B</p>	 <p>18-4259 ARANDELA Reemplaza: 804261</p>	<p>Pack. de 5</p>  <p>18-2530 18-2530-9① ARO SELLANTE Reemplaza: 1336255, 3547991 Bomba circulación culata AQ120B, 125A, B, 131A, 140A, 145A, B, 151A, B, 171A</p>
<p>Pack. de 2</p>  <p>18-2934 18-2934-9① RETÉN GOMA Reemplaza: 829714 AQ90, 95, 100, 105, 110, 115, 120, 130, MD5A, B, C, 7A, B, 11D, MD2001, 2002, 2003T</p>	<p>Pack. de 2</p>  <p>18-2935 18-2935-9① RETÉN GOMA Reemplaza: 418411 AQ90, 95, 100, 105, 110, 115, 120, 130, MB18, 20, BB30, 100, MD11C, D, 17C, D, MD2001, 2002, 2003, 2003T</p>	<p>Pack. de 2</p>  <p>18-2936 18-2936-9① RETÉN GOMA Reemplaza: 418445 AQ90, 95, 100, 105, 110, 115, 120, 130, MB18, 20, BB30, 100, MD11C, D, 17C, D, 2001, 2002, 2003, 2003T</p>	<p>Pack. de 2</p>  <p>18-2937 18-2937-9① RETÉN GOMA Reemplaza: 418412 AQ90, 95, 100, 110, 120B, 125A, B, 131A, 140A, 145A, B, 151A, B, 165A, 170, 171A, MD21A, B</p>

① Precio por pack

<p>Pack. de 5</p>  <p>18-2994 18-2994-9① RETÉN GOMA Reemplaza: 430020 AQ120B, 125A, B, 131A, 140A, 145A, B, 151A, B, 171A</p>	<p>Pack. de 5</p>  <p>18-2996 18-2996-9① RETÉN Reemplaza: 3852560 3.0L GL, GS, 4.3L GL, GS, GI, 5.0L FL, FI, 5.7L GL, GI, 5.8L FL, FI, FSI</p>	<p>Pack. de 2</p>  <p>18-0322 18-0322-9① JUNTA Reemplaza: 3852656 GM 5.0L & 5.7L</p>
<p>Pack de 2</p>  <p>18-2929 18-2929-9① JUNTA PLATINA Reemplaza: 856028 AQ105, 115, 130, BB115, MB20</p>	<p>Pack de 2</p>  <p>18-2939 18-2939-9① RETÉN GOMA Reemplaza: 814356 AQ200, 250, 270, 275, 280, 290</p>	<p>Pack de 2</p>  <p>18-0874 18-0874-9① JUNTA DISTRIBUIDOR Para GM V6 & V8 Reemplaza: 3852109</p>
<p>Pack. de 2</p>  <p>18-0943-2 18-0943-1-9① JUNTA CODO ESCAPE Reemplaza: 3850496 Aplicaciones último Modelo Volvo</p>	<p>Pack. de 2</p>  <p>18-2990 18-2990-9① JUNTA ALOJAMIENTO Reemplaza: 832669 AQ270, 275, 280, 290</p>	 <p>18-2199 ESPACIADOR Reemplaza: 832675 AQ270, 275, 280, 290</p>
 <p>18-2945 18-29451-9① (Pack. de 50) JUNTA TORNILLO DRENAJE Para: usar con tornillo 18-2944 drain screw</p>	 <p>18-2432 LATIGUILLO POWER HIDRÁULICO DELANTERO Reemplaza: 873228 Para: DP, DPX</p>	 <p>18-2433 LATIGUILLO HIDRÁULICO DELANTERO Reemplaza: 873229 Para: DP, DPX</p>
 <p>18-21751 DAMPER Reemplaza: 3853962-3 Reemplaza: 2.5L (1986), 3.0L (1986-90), 4.3L, 5.0L, 5.7L (1986) KW & KWB solo sufixo, 7.4L (1990-98), 8.2L (1992-93,1998)</p>	 <p>18-21752-1 DAMPER Reemplaza: 3858437-1 Para: 4.3L (1986-Actual), 5.0L (1986-88, 1998-Actual), 5.7 (1986-92,1994, 1996-Actual)</p>	 <p>18-21753 DAMPER Reemplaza: 985727, 3853862-5 Para: motores Ford 5.0L & 5.8L (1989-96)</p>

① Precio por pack



18-6456
POLEA
Reemplaza: 855507
Para: 251A, AQ171A, AQ171C



18-9096
BLOQUEADOR COLAS
Volvo 3847547
Para: Volvo SX-A, DPS-A (2007-Sup)



Display Package

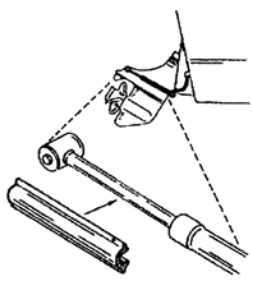

18-9098
BLOQUEADOR COLAS
Reemplaza: 174448
Juego de 2
Para todos los modelos SX hasta 2006



18-2772-1
KIT RETÉN TRANSOM
Para: SX transm

— CONTIENE —

Ref #	Descripción	O.E. #	Cant.
18-2100	Cojinete	3853807	1
18-2765	Fuelle	3854127	1
18-1074	Fuelle	3850426-2	1
18-2996	Retén	3852560, 911823	1
18-710-64-2	Abrazadera	853012-3	1



ABRAZADERA ACERO INOX

Ref #	Tamaño	O.E. #
18-7300 ① ②	50MM	—
18-7306 ① ②	38MM	853548
118-710-48-2	—	3852604
18-710-64-2	122MM	853012



18-2744
KIT FUELLE TRANSMISIÓN
Reemplaza: 875826, 876294
(con arista)
AQ200, 250, 270, 270T, 275, 280, 280T,
PT, 290 DP UNIT: 280, 290



18-2755
KIT FUELLE TRANSMISIÓN
Reemplaza: 875827
SAIL DRIVE: 100S, AQ DRIVE: 100, 100B



18-2757
KIT FUELLE DE ESCAPE
Con válvula
Reemplaza: 875828, 876633
AQ175, 280, 280DP, T, PT, AQD40,
AQAD40, V-8



18-2758
KIT FUELLE DE ESCAPE
Reemplaza: 875848, 876631
AQ200, 250, 270, 275, 280, 280DP,
290, 290DP



18-1074
FUELLE ESCAPE
Reemplaza: 3850426
Para: SX Drives incluye 302, 432,
434, 502, 572, 584, 744 (1994-98)
Usar 18-710-48-2 Clamp



18-2765
FUELLE TRANSMISIÓN
Reemplaza: 3854127
Para: DP-S, SX



18-2766
MANGUITO ESCAPE
Reemplaza: 834751
(D.I. 95MM, Long 160 MM)
V-8

① Este precio es por pieza. Para pedir precio por pack, añadir 9 a la referencia.
② Precio por pack



**18-6523
KIT MUELLES**
For reverse tilt lock: Fits: AQ250, 270, 275, 275A, 280, 280DP, 280L, 285A, 290, 290A, 290DP, SP-A, SP-A/MT, SP-A1, SP-A2, DP-A, DP-A1, DP-A2, DP-B, DP-B1



**18-0184
ARO DE GOMA**
Reemplaza: 804190
Para abrazaderas: Para:230A/SP-A/MT, 250A/SP-A/MT, 500A, 501A, 571A, 740A, AQ100, AQ105, AQ110, AQ115A, AQ110B, AQ120A, AQ120B, AQ125A/B, AQ130A/B, AQ131A/D, AQ175A, AQ190A, AQ200A/C/D/F, AQ210A, AQ211A, AQ225A/B/C/D/E/F, AQ231A/B, AQ240A, AQ255A/B, AQ260A/B, AQ271A/B/C/D, AQ280A, AQ290A, AQ311A/B, AQ60F, AQ80, AQ90, AQ95, AQD19, AQD29/A, AQD32A



**18-8368
ARO DE GOMA**
Reemplaza: 813967
Para abrazaderas: 230A/SP-A/SP, A1, 230B, 250A/B, 251A, 430A/B, 431A/B, 432A, 434A, 500B, 501B, 570A, 572A, 740B, AD31A/B/D/XD, AD40B, AD41A/B/D, AQ100, AQ105, AQ110, AQ115A/B, AQ130A/B, AQ131B/C, AQ140A, AQ145A/B, AQ151A/B/C, AQ171A/C, AQ205A, AQ60F, AQ90, AQ95, AQAD30A, AQAD31A, AQAD40A/B, AQAD41A, AQD19, AQD21A/B, AQD40A, D41A/B/D, KAD32, KAD42A/B/P, KAD43P, KAD44P, KAMD42A, TAMD41A



**CRUCETA CARDAN
(Estilo Rockwell)**

Ref #	O.E. #	Aplicación
18-2104	897707, 853255	AQ200,250,270, 280,290 (Rockwell)
18-2174	3850812	3.0L GS, GL, 4.3L GL, GS, GI, 5.0L GL, GI, 5.7L GL, GI, 5.8L FL, FI, FSI



**18-6406
CRUCETA**
Reemplaza: 3860232
GKN nueva estilo con clip externo.



**18-2100
COJINETE CARDAN**
Reemplaza: 3853807
Para: OMC/Volvo- 3.0L, 4.3L, 5.0L, 5.7L, 7.4L (1994-1998), 5.8L (1994-1996), 8.2L(1998)



**18-2146
PARTE SUPERIOR CARDAN**
Reemplaza: 3850815



**18-2339
CARDAN COMPLETA**
Reemplaza: 3852384



**18-2337
PARTE INFERIOR CARDAN**
Reemplaza: 3850814
Para: 3.0L GS, GL, 4.3L GS, GL, GI, 5.0L FL, FI, 5.7L GL, GI, 5.8L FL, FI, FSI



**18-2128
HORQUILLA CARDAN**
Reemplaza: 3850813, 912213

Modelo	Cardan Completa #	O.E. Cardan Completa #	sup. Cardan #	O.E. Sup Cardan #	Short Yoke #	O.E.Short Yoke #	Doble Cardan #	O.E. Doble Cardan #
SX, DP-SM	18-2339	3852384	18-2146	3850815	18-2337	3850814	18-2128	3850813



**18-4204
CASQUILLO PLÁSTICO**
Reemplaza: 826341, 876278
AQ200, 250, 270, 275, 280, 280DP,290DP,
NO para 270T, 280T, AND 290



**18-2366
CASQUILLO INF**
Reemplaza: 876279
290, 290A, 290DP, SP-A, SP-A1 & SP-A2



**18-4205
CASQUILLO PLÁSTICO**
Reemplaza: 832820
A270T, 280T



**18-4206
TAPA COLAS**
Reemplaza: 832570
AQ200, 250, 270, 275, 280, 290



**FISH LINE
PROTECTOR ESPACIADOR**

Part #	O.E. #	Application
18-4208	839423	AQ280, 290
18-4209	839534	AQ250, 270, 275
18-4234	832965	AQ110S, 200



**18-4210
CONO HÉLICE**
Reemplaza: 850785, 854045
AQ200, 250, 270, 270T, 275, 280, 280T, 280PT, 290



**18-4211
ARANDELA PLÁSTICO**
Reemplaza: 850888



**18-3730
TUERCA MONTAJE**
Reemplaza: 3852648-9
Para: Colas SX

 <p>18-4212 TORNILLO CONO HÉLICE Reemplaza: 850889 (5/16" - 18 rosca)</p>	 <p>18-4213 ESPACIADOR Reemplaza: 851261, 854047 AQ275, 280, 290</p>	 <p>18-4214 ARANDELA CIERRE Reemplaza: 897367 AQ: 200, 250, 270, 270T (TID UTF) 275, 280, 280T, 280PT (TID UTF)</p>	 <p>18-4215 TORNILLO TAPA DE COLA Reemplaza: 941816 (1/4" — 20)</p>											
 <p>18-2153 PASADOR PIVOTE Reemplaza: 814301 AQ200, 250, 270, 275, 280</p>	 <p>18-2454 TAPÓN DRENAJE 3/8" - 16 rosca Reemplaza: 3854539 Para: Volvo SX drives Usar aro 18-7145</p>	<p>② 18-3733D </p>  <p>18-3733 KIT MONTAJE HÉLICE Para: SX Cobra — Contiene —</p> <table border="1"> <thead> <tr> <th>Ref #</th> <th>Descripción</th> <th>Cant.</th> </tr> </thead> <tbody> <tr> <td>18-4194</td> <td>Espaciador</td> <td>1</td> </tr> <tr> <td>18-3708-1</td> <td>tuerca & ret.</td> <td>1</td> </tr> <tr> <td>18-3741</td> <td>Pasador</td> <td>1</td> </tr> </tbody> </table>	Ref #	Descripción	Cant.	18-4194	Espaciador	1	18-3708-1	tuerca & ret.	1	18-3741	Pasador	1
Ref #	Descripción	Cant.												
18-4194	Espaciador	1												
18-3708-1	tuerca & ret.	1												
18-3741	Pasador	1												
 <p>18-4194 ESPACIADOR CAJA ENGRANAJE Reemplaza: 3852350 Para: Caja engr. inferior modelos SX-M (1994)</p>	 <p>18-3708-1 TUERCA HÉLICE Reemplaza: 3850984</p>	<p>Pack. de 10</p>  <p>18-3744 18-3744-9^① PASADOR Reemplaza: 3852255 Para: XDP, MDSSL, MD22P, TMD22, TMD22P, TAMD22P, PJX, SX, DPS, DP, 3.0L GS, GL, 4.3L GL, GS, GI, 5.0L FL, FI, 5.7L GL, GI, 5.8L FL, FI, FSI</p>	<p>Pack. de 3</p>  <p>18-3745 18-3745-9^① PASADOR Reemplaza: 17253-6</p>											
<p>Pack. de 5</p>  <p>18-4238 18-4238-9^① TORNILLO CIERRE Para tapa cola 18-4206 Reemplaza: 943218 AQ200, 250, 270, 275, 280, 290</p>	 <p>18-4239 PALOMILLA CIERRE Para tapa cola 18-4206 Reemplaza: 897873 AQ200, 250, 270, 275, 280, 290</p>	<p>Pack. de 5</p>  <p>18-4241 18-4241-9^① PASADOR Reemplaza: 951924 AQ200, 250, 270, 275, 280, 290</p>	 <p>18-1501 BOLA Reemplaza: 3852023 Para: 3.0L GS, GL, 4.3L GL, GS, GI, 5.0L FL, FI, 5.7L GL, GI, 5.8L FL, FI, FSI</p>											
<p>Pack. de 5</p>  <p>18-3722 18-3722-9^① TUERCAS APRIETE ACERO INOX Reemplaza: 3852005 Para: PJX, SX, DPS, DP, DPX, 3.0L GL, GS, 4.3L GL, GS, GI, 5.0L FL, FI, 5.7L GL, GI, 5.8L FL, FI, FSI, 7.4L GL, GI, GSI, 8.2L GL</p>	 <p>18-0549 TAPÓN 1" Reemplaza: 3852476 Para: 4.3L GL, GS, GI, GSI, 5.0L FL, FI, 5.7L GL, GI, 5.8L FL, FI, FSI, 7.4L GL, GI, GSI, 8.3L GI, GSI, GXI, 8.2L GL, GSI</p>	 <p>18-2138 COJINETE PIVOTE Reemplaza: 3852544 Para: 3.0L GS, GL, 4.3L GL, GS, GI, 5.0L FL, FI, 5.7L GL, GI, 5.8L FL, FI, FSI</p>												

① Precio por pack

② Referencias acabadas en "D" are Display Packaged - Referencias normales no envasadas

El Zinc es solo para aplicaciones de agua salada.
 Magnesio solo para aplicaciones agua dulce.
 Aluminio es tanto para agua dulce como para agua salada



③ 18-6123Z
ANODO
 Reemplaza: 873395
 Transom



③ 18-6124Z
ANODO
 Reemplaza: 872793
 Brazo dirección DPS



① 18-6125A
 ② 18-6125M
 ③ 18-6125Z
PLATINA TRANSOM
 Reemplaza:
 3586461 (Aluminio)
 3855610 (Magnesio)
 3854130 (Zinc)



① 18-6126A
 ② 18-6126M
 ③ 18-6126Z
ANODO TRANSOM
 (con tornillo)
 Reemplaza:
 3888816 (Aluminio)
 3888818 (Magnesio)
 3888817 (Zinc)
 SX-A, DPS-A, DPS-A Oxi



① 18-6127A
 ② 18-6127M
 ③ 18-6127Z
ANODO TRANSOM
 (con tornillo)
 Reemplaza:
 3888813 (Aluminio)
 3888815 (Magnesio)
 3888814 (Zinc)
 SX-A, DPS-A, DPS-A Oxi



③ 009347
 ① 18-6000A
 ② 18-6104
ANODO
 Reemplaza: 832598,
 873179
 Para 200, 250, 250C, 250D, 270,
 270B, 270C, 270D, 275, 280,
 280C, 280D, 280DP, 280L, 280PT



③ 025851
ANODO
 Reemplaza: 838929
 AQ200 (For shield), MD19, 21,
 27, 29, 32, 2003, AQ30, 31, 40, 41
 Para refrigeración



③ 009346
 ① 18-6004A
 ② 18-6105
ANODO
 Reemplaza: 852835,
 873178
 Para 290, 290A, 290ADP, 290B



③ 009350
ANODO
 Reemplaza: 875805
 AQ250, 270, 270T, 275



③ 009351
 ① 18-6009A
ANODO
 Reemplaza: 875815



③ 025840
 ① 18-6028A
 ② 18-6102
ANODO
 Reemplaza: 3855411, 984513
 (18-6028), 3863193 (18-6028A),
 3855412 (18-6102)
 Para usar con caja engranajes: 2.3L (1987-90),
 2.6L/ 3.5L/4.6L (1989), 3.0L/4.3L/5.0L/5.8L
 (1987-93), 5.7L (1987-92), 7.4L (1987-88)



③ 009352
 ① 18-6010A
 ② 18-6106
ANODO
 Reemplaza: 875821
 280DP, 290DP



18-6130
ANODO
Reemplaza: Volvo
Para: Colas Volvo IPS



18-6131
ANODO
Reemplaza: Volvo
Para: Colas Volvo IPS



18-6128A
KIT ANODO
Reemplaza: Volvo
Para: Colas Volvo SX-A & DPS



18-6128M
KIT ANODO
Reemplaza: Volvo
Para: Colas Volvo SX-A & DPS



18-6128Z
KIT ANODO
Reemplaza: Volvo
Para: Colas Volvo SX-A & DPS



18-6129A
KIT ANODO
Reemplaza: Volvo
Para: Colas Volvo DPH



18-6129M
KIT ANODO
Reemplaza: Volvo
Para: Colas Volvo DPH



18-6129Z
KIT ANODO
Reemplaza: Volvo
Para: Colas Volvo DPH



18-1076
FUELLE
Reemplaza: Volvo 3888916
Para: Colas Volvo SX-A & DPS-A



③ **18-6021**
TAPÓN ANODO
Reemplaza: 838928
AQ30, 31, 40, 41, MD10, 21,
27, 29, 32, 2003



18-2598
KIT RETÉN ALOJAMIENTO ENGRANAJE
Reemplaza: 3855275
Para: Volvo SX hasta 2006



18-2586
KIT RETÉN UNIDAD SUPERIOR
Reemplaza: 3850594
Para: Volvo SX hasta 2006

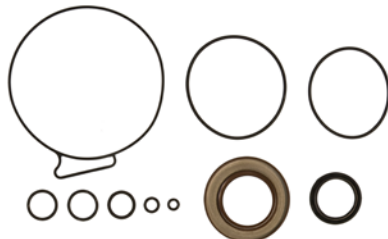

18-2726
KIT RETÉN UNIDAD SUPERIOR
Reemplaza: 3888917
Para: Volvo SX-A/DPS-A (2007& Sup)

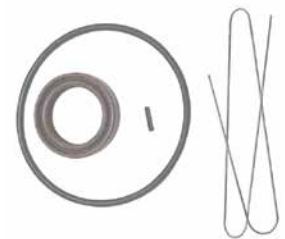

18-3893
KIT JUNTAS CAMBIO
Para: 275A, 280, 280DP, 280T, 285A, 290, 290A, 290DP, SP-A, SP-A/MT,
SP-A1, SP-A2, SP-C, SP-C1, DP-A, DP-A1, DP-A2, DP-B, DP-B1, DP-C,
DP-C1, DP-D, DP-D1, DP-E, DP-G, DPX, DPX-S, XDP-B

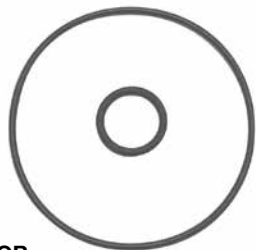

18-2597

KIT RETÉN UNIDAD SUPERIOR

Para alojamiento intermedio: Para: 200, 250, 270, 270T, 275, 275A, 280, 280DP, 280T, 285A, 290, 290A, 290DP, SP-A, SP-A/MT, SP-A1, SP-A2, SP-C, SP-C1, DP-A, CP-A1, DP-B, DP-B1, DP-C, DP-C1, DP-D, DP-D1, DP-E, DP-G, DPX, DPX-S, DPX-S1



18-3888

KIT RETÉN UNIDAD INFERIOR

Para alojamiento intermedio: Para:200, 250, 270, 270T, 275, 275A, 280, 280DP, 280T, 285A, 290, 290A, 290DP, SP-A, SP-A/MT, SP-A1, SP-A2, SP-C, SP-C1, DP-A, CP-A1, DP-B, DP-B1, DP-C, DP-C1, DP-D



18-8357

KIT DE RETENES COMPLETO

Reemplaza: 875741
Para: 280DP/290DP

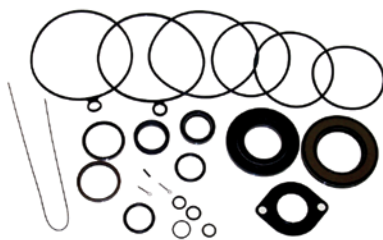

18-8361

KIT RETÉN SUPERIOR

Reemplaza: 576266-8
Para: AQ200-AQ290

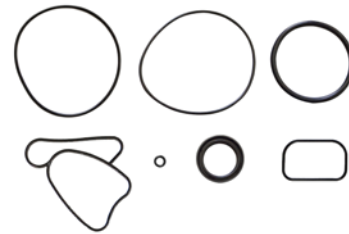

18-2583

KIT RETÉN UNIDAD INFERIOR

Reemplaza: 3888821
Para: Colas SX-A (2007 y SUP)



18-2584

KIT RETÉN UNIDAD INF

Reemplaza: 3888822
Para: Colas DPS-A (2007 y SUP)

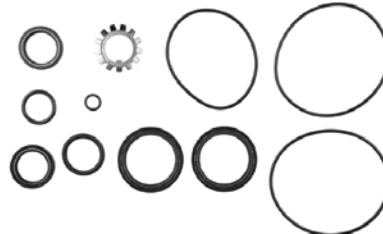

18-8358

KIT RETENES INFERIOR

Reemplaza: 876267
Para: 280DP/290DP



18-8359

KIT RETENES ENGRANAJE SUPERIOR

Reemplaza: 876268
Para: AQ200-AQ290



18-2791

KIT RETENES ENGRANAJE INFERIOR

Reemplaza: 3850597

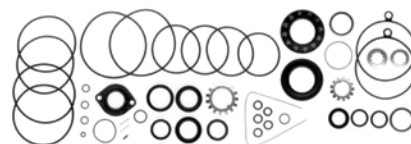

18-2625

KIT JUNTA COLAS

Reemplaza: 875192
AQ200, 250, 270, 275, 280, 290



18-32882

RETÉN TUBO AGUA

Reemplaza: 3852315



RETENES ACEITE

Ref #	O.E. #	Dimensiones (mm)		
		D.I.	D.E.	ancho
18-0558	851407	44	58.33	7
18-2039	804695	13	25.4	6
18-2040	853670	45	75	8
18-2041	897426	33	45.25	7
18-2043	958838	25	35	7
18-2044	833996	12	24	7
18-2045	827247	16	28	7
18-2046	946242	35	55	10
18-2047	958860	35	62	7
18-2057	181620	34	42	4

ARO TÓRICO

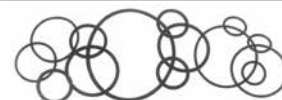

Dimensiones (mm)					Dimensiones (mm)				
Ref #	Pack.	O.E. #	D.I.	ancho	Ref #	Pack.	O.E. #	D.I.	ancho
18-7122		925095	—	—	18-7182①	5	925092	55	3
18-7154		949656	—	—	18-7183①	5	925093	69.5	3
18-7102①	5	3852073	.430	.065	18-7184①	5	925256	79	3
18-7116		3852045	.360	.10	18-7186①	5	925259	102	3
18-7135		3852089	.750	.135	18-7187①	5	925261	106	3
18-7141①	5	3852165	.180	.065	18-7188①	5	955983	9.1	1.6
18-7143①	5	3852169	1.310	.100	18-7190①	5	925065	34	3
18-7149①	5	955989	1.5	1.5	18-7192①	5	955995	25.1	1.6
18-7162①	5	3852044	2.025	.135	18-7193①	5	955974	10.3	2.4
18-7168①	5	3852033	.370	.065	18-7194①	5	956000	37.1	1.6
18-7178①	5	125017	23.5	3.5	18-7406①	5	3852523	.250	.065
18-7180①	5	925055	11.3	2.4	18-7407①	5	3852531	4.125	.135
18-7181①	5	925091, 975672	50.5	3					

① Este producto es precio por pieza. Para pedir envasado añada 9 a la referencia. Referencia normal no envasada.



VOLVO



BUJÍAS VOLVO

POTENCIA HP	NGK STD.	Ref. PRONAUTIC	POTENCIA HP	CHAMPION	Ref. PRONAUTIC
SERIES AQ			SERIES AQ		
145A, B	BP7ES	050821	120 (B21)	RN7YC	050979
130, A, B, C, D	BP7HS	050822	125A,B, 145	RN7YC	050979
131, A, B, C, D, 140A	BP7ES	050821	130, A, B, C, D	RL82YC	050952
150, A, B	XR5	050606	131, A, B,C ,D	RN7YC	050979
151A, B, C	BP7ES	050821	140, A, 145A,B	RN7YC	050979
165A, 170, A, B, C	BP7HS	050822	151 A,B,C	RN7YC	050979
171A, C	BP6ES	050819	165 A	RL82YC	050952
175, 175A	YR5	050709	170, A, B, C	RL82YC	050952
180	XR5	050606	171 A, C	RN9YC	050948
190	YR5	050709	175, 175A	RV15YC4	050928
200, A, B, C, D, F	UR5	050607	180	RJ12YC	050980
210A DESDE from 177315	UR6	050608	190 FORD, 190A FORD	RV15YC4	050928
211/DP, 211A	YR5	050709	200, A, B, C, D, F, 205A	RV15YC4	050928
225, A, B, C, D	UR6	050608	210A DESDE from 177315	RV9YC	050930
225E,F	YR5	050709	211A, 211/DP,231D/P, 271D/P	RV15YC4	050928
230A, B, 250A, B	BPR6ES	050826	255, A, C	RV15YC4	050928
231/DP, 231A,B	YR5	050709	255D, 305 CID, 225E,F	RV15YC4	050928
240A, 255B	UR6	050608	230A/B, 250A/B	RN7YC	050979
260, A, B	BR6FS	050831	231A, B, 240A FORD, 255B, 280A	RV15YC4	050928
271/DP	YR5	050709	260A, B, 271A, B, C, D, 290, A,	RV15YC4	050928
271A, B, C, D	BR6FS	050831	311, A, B, 430, 531, 500A, 501A	RV15YC4	050928
280A	UR6	050608	570A, 571A, 572, 740A	RV15YC4	050928
290A, 290B, 311A, 311B	BR6FS	050831	SERIES B/BB		
430, 500A, 501A, 531, 570A	BR6FS	050831	18A, 18C, 30B	RL82C	050924
571A, 572, 740A	BR6FS	050831	100, A	RL86C	050925
SERIES DPX			115A, B, 165A	RL82YC	050952
5.7L DPX 375	TR55	050877	140	RN9YC	050948
7.4L DPX 385 GSi EFI	BR6FS	050831	145, A	RN7YC	050979
8.1L DPX 420	TR55	050877	SERIES OCEAN		
8.2L DPX 415 GSi EFI	BR6FS	050831	GM V-6, 2002 4.3L OSi-XDP	RS12YC	050949
SERIES DUOPROP			GM V-8, 2002 5.0L OSi-XDP	RS12YC	050949
4.3L Gi EFI (.460 Rch.)	BPR6FS	050700	GM V-8, 2002 5.7L OSi-XDP	RS12YC	050949
4.3L Gi EFI (.708 Rch.)	BPR6EFS	050857	GM V-8, 2002 5.7L OSXi-XDP	RS12YC	050949
4.3L GL 2 bbl, GS 4	BPR6EFS	050857	PJX Water Jet		



VOLVO



POTENCIA HP	NGK STD.	Ref. PRONAUTIC	POTENCIA HP	CHAMPION	Ref. PRONAUTIC
5.0L Fi EFI	TR5	050708	4.3L Gi, GS	RS12YC	050949
5.0L FL 2 bbl	UR4	050878	SERIES SX Cobra		
5.0L Gi, GL Gen 1+	BPR6EFS	050857	3.0L GS	RS12YC	050949
5.7L Gi EFI	BPR6FS	050700	4.3L GIPNCA	RV15YC4	050928
5.7L GL 2 bbl	BR6FS	050831	4.3LGIPNCS	RS12YC	050949
5.7L GLi EFI	BPR6FS	050700	5.0L FL	RV15YC4	050928
5.7L GS 4 bbl	BR6FS	050831	5.0L Fi, Gi Gen 1+, GL Gen 1+	RS12YC	050949
5.7L GS, GSi Gen 1+	BPR6EFS	050857	5.7L Gi, GL, GLi, GS	RV15YC4	050928
5.7L GXi	TR55	050877	5.7L GS Gen 1+, GSi Gen 1+	RS12YC	050949
5.8L FL 4 bbl	UR4	050878	SERIES B/BB CONT.		
5.7L FSi EFI HO	BPR6EFS	050857	225, A, B, C, 231A	RV15YC4	050928
7.4L Gi EFI, Gi L29	BPR6EFS	050857	260, A, B, C, 261	RV15YC4	050928
7.4L GL 4 bbl	BR6FS	050831	SERIES C		
7.4L GSi EFI	BR6FS	050831	C5, C10, C23	RD16	051027
8.1L Gi/Gsi	TR4	050879	SERIES DPX		
8.1L GXi	TR55	050877	7.4L DPX 385	RV15YC4	050928
8.2L GSi EFI	BR6FS	050831	8.2L DPX 415	RV15YC4	050928
PJX Water Jet			SERIES DUOPROP		
4.3L Gi EFI	BPR6EFS	050857	4.3L GIPNCA	RV15YC4	050928
4.3L GS 4 bbl	BPR6EFS	050857	4.3L GIPNCS	RS12YC	050949
SX Cobra Grande			5.0L FL	RV15YC4	050928
3.0L GS 2 bbl	BPR6EFS	050857	5.0L Fi, 5.0L GL Gen 1+	RS12YC	050949
4.3L Gi EFI (.460 Rch.)	BPR6FS	050700	5.0L Gi GEN 1+	RS12YC	050949
4.3L Gi EFI (.708 Rch.)	BPR6EFS	050857	5.7L Gi, GL, GLi, GS	RV15YC4	050928
4.3L GL 2 bbl	BPR6EFS	050857	5.7L GS Gen 1+, GSi Gen 1+	RS12YC	050949
4.3L GS 4 bbl	BPR6EFS	050857	5.8L FL	RV15YC4	050928
5.0L Fi EFI	TR5	050708	5.8L FSi	RS9YC	050955
5.0L FL 2 bbl	UR4	050878	7.4L Gi, GL	RV15YC4	050928
5.0L Gi Gen 1+	BPR6EFS	050857	7.4L Gi L29	RS12YC	050949
5.0L GL Gen 1+	BPR6EFS	050857	7.4L GSi, 8.2L GSi	RV15YC4	050928
5.7L Gi EFI	BPR6FS	050700	SERIES ALTA CILINDRADA		
5.7L GL 2 bbl	BR6FS	050831	8.2L DPX 500, DPX 525	V63C	050946
5.7L GLi EFI	BPR6FS	050700	8.2L DPX 600	V63C	050946
5.7L GS 4 bbl	BR6FS	050831	SERIES M		
5.7L GS Gen 1+	BPR6EFS	050857	MB36A, MB36B	RJ12YC	050980



VOLVO



POTENCIA HP	NGK STD.	Ref. PRONAUTIC	POTENCIA HP	CHAMPION	Ref. PRONAUTIC
5.7L GSi Gen 1+	BPR6EFS	050857	MB250S	P8Y	050964
5.7L GXi	TR55	050877	PZ-200	RV15YC4	050928
5.8L FL 4 bbl	UR4	050878	AQ60F, BB30F, MB18F	L90C	051028
5.8L FSi EFI HO	BPR6EFS	050857	SERIES SX Cobra CONT.		
7.4L Gi EFI	BPR6FS	050700	5.8L FL	RV15YC4	050928
7.4L Gi L29	BPR6EFS	050857	5.8L Fi, FSi	RS9YC	050955
7.4L GL 4 bbl	BR6FS	050831	7.4L GL, Gi	RV15YC4	050928
SERIES OCEAN			7.4L Gi L29	RS12YC	050949
4.3L OSi-XPD	TR5	050708	SERIES INTRABORDA Inboard		
5.0L OSi-XPD	TR5	050708	2002, 5.7L Gi	RV15YC4	050928
5.7L OSi-XPD	TR5	050708	2002, 5, 5.7L GSi, GXi	RS12YC	050949
5.7L OOXi-XPD	TR5	050708	5.8L FL/HS1	RV15YC4	050928
			5.8L FSi/HS1	RS9YC	050955
			7.4L GL, Gi/HS1	RV15YC4	050928
			7.4L Gi L29 STANDARD	RS12YC	050949
			7.4L Gi L29 PLATINUM	RS12PYP	050978
			2002, 8.1L Gi/GSi	RS15LYC	051029

TURBOS PARA MOTORES VOLVO

MODELO MOTOR	REFERENCIA ORIGINAL	REFERENCIA PRONAUTIC	JUNTA
KAD 32 P	3581528	VOL6016	VOL3582676
KAD SERIES	3802082	VOL6094	VOL3582676
KAD 300, TAMD 41, KAMD 43/52	838679	VOL6497	VOL3582676
KAD 44	838695	VOL6496	VOL3582676
MD 40, TMD40, TAMD40, AQD40	3802033	VOL6492	VOL3582676
PERKINS	4667705008 S	VOL6770	VOL3582676
KAD 300	3583006	VOL7200	VOL3582676

TURBOS VOLVO







Lubricante TK-1

101265

Penetra y disuelve el óxido permitiendo el desmontaje de las partes mecánicas y tornillería.

Expele la humedad y protege la oxidación de las partes eléctricas facilitando los contactos. No ataca las materias plásticas y barnices. No contiene silicona. Envase de 400ml.

Lubricante TK-2

101267

Reduce el mantenimiento, su acción de protección se mantiene durante 1 año. Protege los motores y los equipos mecánicos que trabajan en ambientes marinos o corrosivos. No ataca la goma, las pinturas y las materias plásticas.

Lubricante TK-3

101268

Lubricante especial con altas prestaciones, que se prestan de manera especialmente óptima al mantenimiento y protección de partes mecánicas en movimiento continuo, operando en condiciones ambientales difíciles. Lubrica en seco, creando un film protector de elevada durabilidad y resistencia a la acción mecánica que preserva las partes tratadas de la corrosión. Ideal para el ambiente marino, gracias a su total adhesividad e hidropelencia. Envase de 40ml.

Lubricante Synt

101269

Lubricante de síntesis. Excelente viscosidad a altas temperaturas. Puede operar en condiciones extremas de temperatura y fricción. Bajo índice de congelación y alta protección contra la corrosión. Especialmente indicado para cambios, engranajes cadenas de transmisión y otros equipos mecánicos que trabajen en duras condiciones. Temperatura de trabajo -15°+250°. Envase de 400ml.



Aceite Engranajes

Aceite de altísima calidad muy apto para el engrase de las cajas de transmisión de fuerabordas y colas intra/fuerabordas.

Contiene aditivos antioxidantes para guardar invariables las características del aceite en los periodos de inactividad. Aditivo antidesgaste y presión extrema para reducir el desgaste de las partes metálicas en contacto. Supera las especificaciones OMC 1632.

101275

Envase tubo de 250ml.

101276

Envase bidón de 25lts.



Grasa

Grasa Premium Marine formulada específicamente para aplicaciones marinas.

189200

Fórmula Premium de litio para óptima protección a la corrosión en aplicaciones en agua dulce y salada. Ideal para cojinetes de remolques, cardanes y pivotes de colas. Tubo de 283,5gr.

18-97101

Cartucho de 397gr.



02456900



1895503



Aceite Invernaje

Protege las partes internas del motor de la oxidación y de la corrosión. Especialmente diseñado para la protección estacional de los motores intraborda y fueraborda. Ideal para motores de 2 y 4 tiempos. Proporciona una protección química con una película sobre la superficie sin dejar residuos grasos.

02456900

Envase de 340gr.

1895503

Envase 3,8lts

189502



189503



Aceite Motor 2 tiempos

Aceite "Blue" Premium TC-W3 lubricante de altas prestaciones. Ideal para sistemas de inyección o pre-mezcla, óptimo quemado para la combustión sin humos. Deslizante más rápido, combustión más limpia. Reduce significativamente la toxicidad en el mar, comparado con otros aceites fueraborda del mercado. Máxima lubricación. Reduce la fricción de aros, la formación de depósitos de carbónilla y bloqueo de válvulas de escape. Ideal para fuerabordas actuales de altas potencias que necesitan las máximas prestaciones.

Sintético para motores BRP E-Tech / Universal.

189502

Envase de 946ml.

189503

Envase de 3,78lts.

1895402

Sintético. Envase de 946ml.

1895403

Sintético. Envase de 3,78lts.

189422



189423



Aceite Motor Fueraborda 4 Tiempos

Aceite 10W-30 para motores fueraborda de 4 tiempos. Formulado con una base Premium y con aditivos altamente refinados. Especialmente formulado para los motores marinos de 4 tiempos Mercury, Yamaha, Johnson-Evinrude, Suzuki y Honda. Reduce la fricción. Protección máxima frente la corrosión. La baja temperatura del fluido ofrece mejor arranque en frío. Mantiene el motor limpio y mejora su eficiencia. **Cumple las normativas API SJ, CF-2, CH4.**

189422

Envase de 946ml. Mercury 92-802833Q1

189423

Envase de 3,78lts. Mercury 92-802835Q1

1896902

Envase de 946ml. Sintético.

1896903

Envase de 3,78lts. Sintético.

1895536

Envase de 61lts.



Lubricante Power Trim&Tilt 189750

Formulado para operar a altas Presiones. Aditivos antiespuma aseguran un fluido uniforme. Diseñado para aplicaciones sujetas a cambios de temperatura.



Aceite Motor Intraborda 4 Tiempos

Aceite 25W-40 para motores Intraborda 4 tiempos. Formulario para dar una excelente lubricación y protección contra la corrosión. Este producto está desarrollado para el ambiente marino y es el adecuado para motores de 4 tiempos standard. Los beneficios para su motor son una reducción del desgaste de sus componentes internos, protección frente la corrosión, pistones más limpios. Baja temperatura de operación. Recomendado para motores mercruiser, OMC y Volvo Penta. **Cumple las normativas API SJ, CF-2, CH4.**

189402

Envase de 946ml. Mercruiser 92-802837Q1

189404

Envase de 4,7lts. Mercruiser 92-857389-A1

1894402

Sintético. Envase de 946ml. Mercruiser 92-883724K01

1894404

Sintético. Envase de 4,7lts. Mercruiser 92-883725K01

1895532



Aceite de Motor Diésel 15W-40

Primer aceite diésel ofrecido por Sierra. Con las siguientes especificaciones de fabricación: Volvo VDS-3; Cummins CES200078, CES20077, CES200776; Detroit Diésel DDC93D124; Cat ECF-2, ECF-1; Global DHD-1. Mayor cantidad de detergente para combatir hollín y depósitos de carbón. Certificada por APC CL-4 + Rating. **Se ajusta a las normas más exigentes de gasóleo en la industria marítima.**

1895532

1 lt.

1895533

3,8lt.

1895535

18,9lts

1895536

61 lt.

1895537

208lts.

189600



189602



189605



Aceite Colas “Premium”

Lubricante Premium para colas recomendado para todas las aplicaciones marinas en general que requieran lubricante clase GL-5. Ideal para reemplazar todas las antiguas aplicaciones de hypoid 90. Formulado para usar en aplicaciones standard, reduce la fricción y protege los engranajes, cojinetes y otros componentes.

Reemplaza: Mercury (Quicksilver). Premium Blend. OMC (system Matched). Hi-Vis lubricant. Yamaha (Yamalube). LUB-GEAR-11-04

189600

Envase de 283,5gr

189602

Envase de 946ml.

189605

Envase de 18,95lts.

189650



189652



189655



Aceite Sintético Colas

Lubricante sintético para colas que reduce la fricción incrementado las prestaciones y protegiendo los engranajes, cojinetes y otros componentes. Recomendado para uso en condiciones de operación de altas prestaciones, en colas de fueraborda e intrabordas.

Reemplaza: Mercury (Quicksilver). OMC (system Matched). Hi-Performance Blend. Hi-Vis lubricant. Yamaha (Yamalube). LUB-GEAR-11-04

189650

Envase de 283,5gr

189652

Envase de 946ml.

189655

Envase de 18,95 lts.

189528



Aceite 25W-40

Semi-sintético para motores MERCURY VERADO.

189528

Envase de 1 lt.

189523

Envase de 4 lts. Mercury 92-858084 K01.

189526

Envase de 61 lts.

189443

189448



Aceite 25W-40

Sintético para motores fueraborda.

189443

Envase de 4 lts. Mercury 92-883723K01.

189448

Envase de 946ml . Mercury 92-883722K01.

189513

189512



Aceite 10W-40

Semi-sintético para motores SUZUKI.

189512

Envase de 946ml. Suzuki 990C0-10W40-1 QT.

189513

Envase de 3,78 lts. Suzuki 990C0-10W40-1 GL.

189516

Envase de 61 lts.

189517

Envase de 208 lts.



1894104

1894102



Aceite SAE 30

Sintético para motores intraborda diesel y gasolina.

1894102

Envase de 946ml. Volvo 3842343.

1894104

Envase de 4,7 lts. Volvo 3842344.

1896802



Aceite de engranajes

Sintético formulado para reducir el desgaste.

1896802

Envase de 946 ml. Volvo 1141679

1896805

Envase de 19 lts. Volvo 114681.

Manguera de Combustible

Tubo de goma para el transporte de carburante (diésel o gasolina). Conforme según normativa ISO 7840: 2004 A1 CE. Temperatura de -30 °C a 100°C. Resistente a la abrasión de los agente marinos.

Ø	Ref. Tramo	Ref. Granel
6mm	1360001 -10mts	136000 -40mts
8mm	1360011 -10mts	136001 -40mts
10mm	1360021 -10mts	136002 -40mts
12mm	1360031 -10mts	136003 -20mts
16mm	1360041 -10mts	136004 -40mts
19mm	1360051 -10mts	136005 -20mts
25mm	1360061 -10mts	136016 -20mts
30mm	1360071 -10mts	136017 -20mts
32mm	1360081 -10mts	136018 -20mts
35mm	1360091 -10mts	136019 -20mts
38mm	1360201 -10mts	136020 -20mts
40mm	1360211 -10mts	136021 -20mts
45mm	1360221 -10mts	136022 -20mts
51mm	1360231 -10mts	136023 -20mts
60mm	1360241 -10mts	136024 -30mts

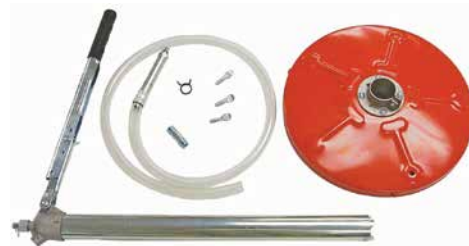

Bomba de Aceite

189788

Bomba para utilizar en fuerabordas e intrafuerabordas. Diseñado para utilizar en envases Ref. 189605 y Ref. 189655 y Bidones.



Bomba de Aceite

189781

Bomba de aceite. Incluye terminales de aceite con línea de llenado flexible. Adaptable para utilizar en envases Ref. 189600 y Ref. 189652.

Indicador digital

112413

Funcionamiento a 12V/24V.



Manguera para Fuerabordas

Tubo de goma para motores fueraborda. Funcionamiento con gasolina sin plomo y diésel. Alta flexibilidad. Temperatura de -35°C a +90°C. ISO R-1307

Ø	Ref. Tramo	Ref. Bobina
6mm	1360141 -25mts	136014 -50mts
8mm	1360151 -25mts	136015 -50mts
10mm	1361161 -25mts	136116 -50mts

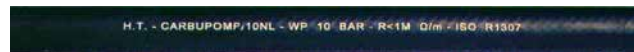

Manguera para Fuerabordas

Manguera de PVC para el trasvase de carburantes y alimentación de motores fueraborda. ISO R-1307

Ø	Ref. Tramo	Ref. Granel
7mm	1360831 -25mts	136083 -50mts
8mm	1360841 -25mts	136084 -50mts





Línea de Combustible Universal

Kit de bomba de combustible y manguera PVC de Ø 8x13mm, sin conectores.

112356

Longitud: 2mts.

112358

Longitud: 3mts.



Kit bomba de combustible y manguera Sirflex de 7x12mm, sin conectores.

112351

Longitud: 2mts.

112355

Longitud 3mts.



Kit bomba combustible y manguera Sirflex de Ø 9x14mm, sin conectores.

112364

Longitud: 2mts.

112365

Longitud: 3mts.



Bomba de Succión

112350

Bomba de combustible Sirflex, resistente a gasolina sin plomo. Para mangueras de 8mm.



Línea de Combustible Mercury/Yamaha

112357

Kit bomba combustible y manguera reforzada de PVC de Ø 8x13mm. Con 1 conector macho Mercury +1 conector hembra Yamaha. Longitud 2mts.



Línea de Combustible Yamaha

112363

Kit bomba de combustible y manguera reforzada de PVC de Ø 8x13mm. Con 1 conector hembra Yamaha. Longitud: 2mts.

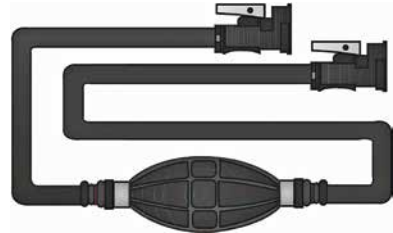

112361

Kit bomba de combustible y manguera reforzada de PVC de Ø 8x13mm. Con 2 conectores hembra Yamaha. Longitud 2mts.



Bomba de Succión

112352

Bomba "HI:TECH" adaptada para motores fueraborda de cualquier potencia. Permite un flujo de más de 100lt., Por hora. "HI.TECH" es una bomba de calidad superior que mantiene la misma flexibilidad en temperaturas de -20°C a 60°C. Se adapta a carburante sin plomo, gasolina normal, súper y diésel. Para mangueras de 8/10mm.

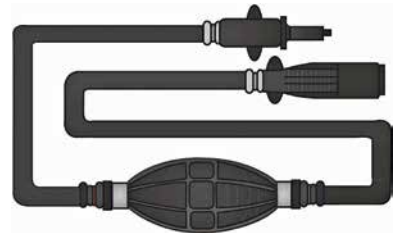

Línea de Combustible Mercury

112359

Kit bomba combustible y manguera reforzada de PVC de Ø 8x13mm. Con 1 conector macho Mercury +1 conector hembra Mercury. Longitud: 2 mts.

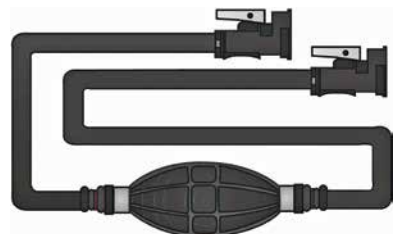

112370

Kit bomba combustible y manguera de PVC de Ø 8x13mm, con 2 conectores hembra Mercury. Longitud: 2mts.

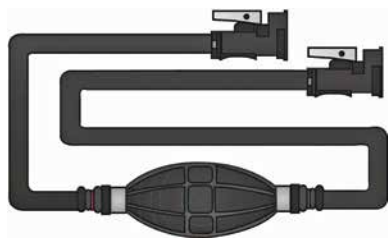

Línea de Combustible OMC

112360

Kit bomba combustible y manguera reforzada de PVC de Ø 8x13mm. Con 2 conectores hembra OMC. Longitud: 2mts.

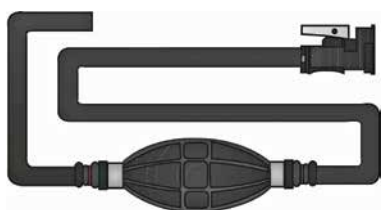

112362

Kit bomba combustible y manguera reforzada de PVC de Ø 8x13mm. Con 1 conector hembra OMC. Longitud: 2mts.



188009

Línea de combustible para motores Jonhson/Evinrude, compuesta de bomba y manguera 8mm. Con 2 conectores Ref. 188056. Longitud: 2mts.



188017

Línea de combustible para motores Yamaha,Mercury/ Mariner, compuesta de bomba y manguera 9mm. Con 2 conectores Ref. 188076.



188027

Línea de combustible para motores Nissan/Tohatsu, compuesta de bomba y 8mm. Con 2 conectores hembra Ref. 188079 + Ref. 188088. Longitud: 2 mts.



Bomba de Succión

112352

Bomba "HI:TECH" adaptada para motores fueraborda de cualquier potencia. Permite un flujo de más de 100lt. Por hora. "HI.TECH" es una bomba de calidad superior que mantiene la misma flexibilidad en temperaturas de -20°C a 60°C. Se adapta a carburante sin plomo, gasolina normal, súper y diésel. Para mangueras de 8/10mm.



Líneas de Combustible Sierra

188013

Conjunto manguera de combustible tipo Premium, compuesto por bomba de máxima calidad y manguera 8mm. De goma Silverado 2000. Se mantiene flexible aún en bajas temperaturas, abrazaderas de acero inoxidable. Sin conectores. Longitud: 2mts.



188010

Línea de combustible para motores Mercury/Mariner, compuesta de bomba y manguera 8mm. Con 2 conectores Ref. 188069 +Ref. 188070. Mercury, uno macho y otro hembra. Longitud: 2mts.



188018

Línea de combustible para motores Suzuki, Nissan/ Tohatsu, compuesta de bomba y manguera 8mm. Con 2 conectores hembra Ref. 188079.



Bomba de Succión Sierra

188004

Bomba de combustible para manguera de 8mm. Resistente a los rayos UV.



Bomba de Succión

112350

Bomba de combustible Sirflex, resistente a gasolina sin plomo. Para mangueras de 8mm.



Abrazaderas para Línea de Combustible Sierra.

188020

Abrazaderas para manguera de 8mm.

188021

Abrazaderas para manguera de 9mm.



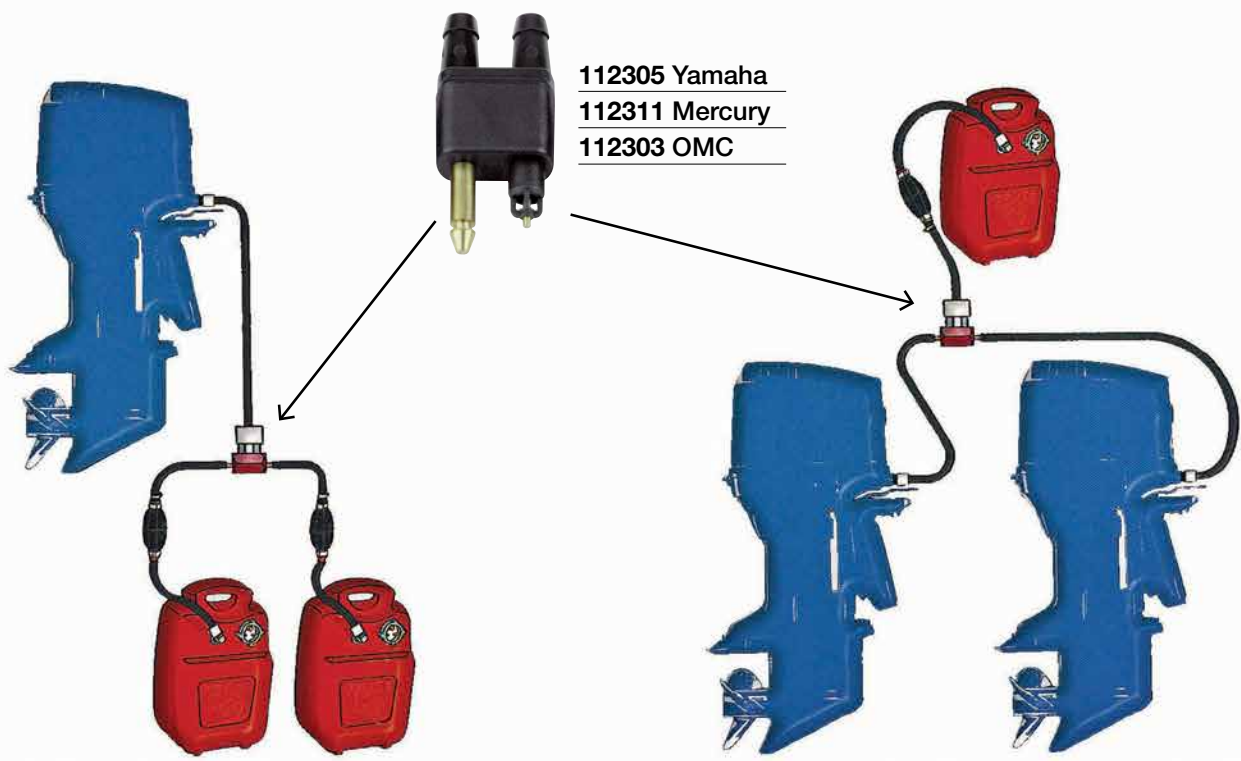
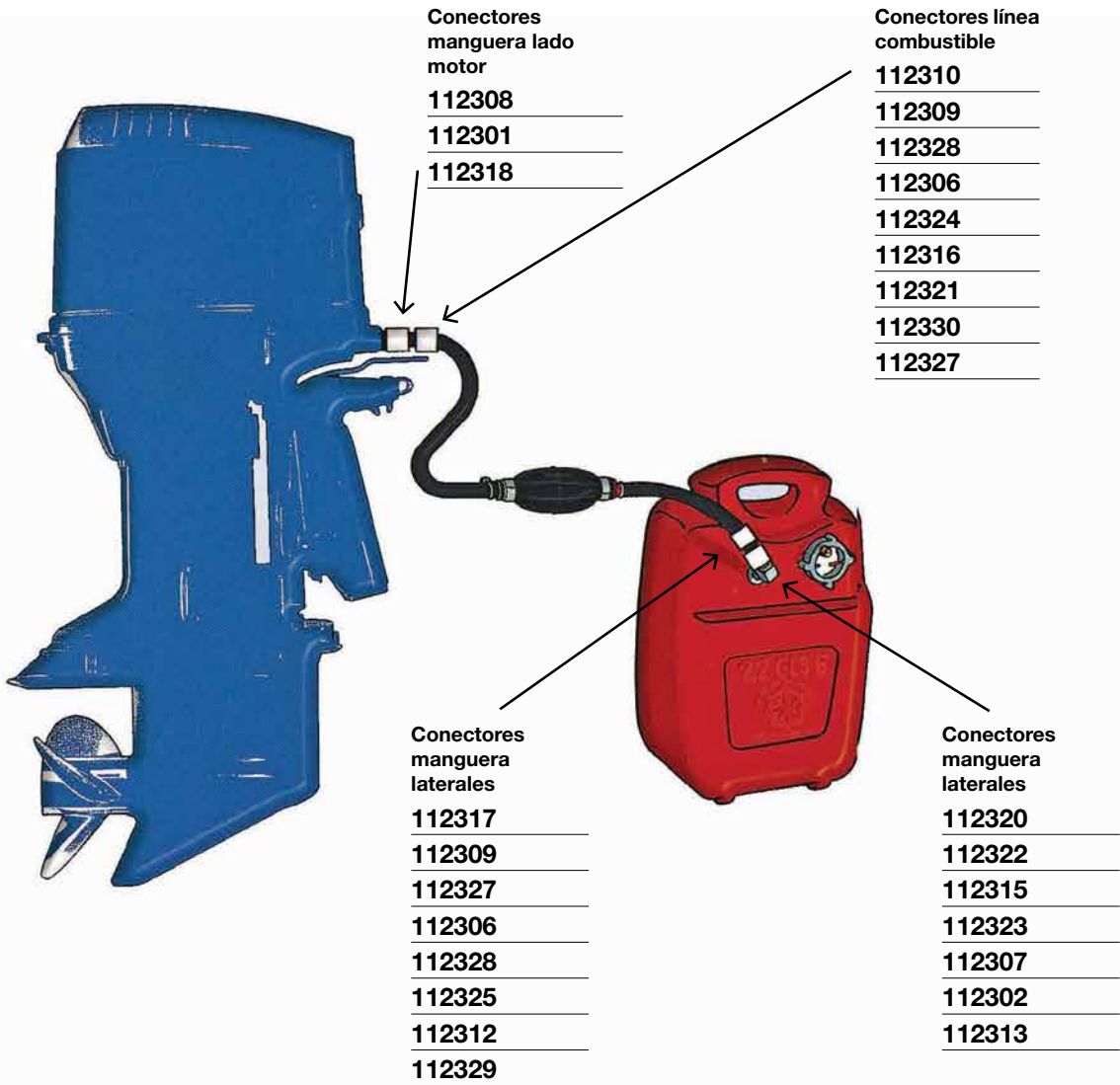

Todos los conectores se adaptan a las mangueras de diámetro interior 7mm., 8mm. y 9mm.

Conector Macho

112326

Conector macho OMC, para manguera combustible universal.



Conector Macho

112301

Conector macho OMC con válvula motor.



Conector Depósito

112307

Conector macho roscado OMC, para depósito.



Conector Hembra

112331

Conector Hembra HONDA desde el 2004.



Conector Hembra

112309

Conector hembra OMC, lado motor y depósito.



Conector Hembra

112328

Conector hembra. YAMAHA/MARINER/MERCURY para manguera motor, también depósito YAMAHA.



Conector Hembra

112327

Conector hembra OMC para manguera motor y depósito.



Conector Doble

112305

Conector macho YAMAHA, con válvula, doble salida universal para utilizar con 2 motores o 2 depósitos con una sola línea de combustible.



Conector depósito

112302

Conector macho roscado YAMAHA, para depósito.



Conector Macho

112308

Conector macho YAMAHA/MARINER/MERCURY.



Conector Doble

112303

Conector macho OMC, con válvula, doble salida universal para utilizar con 2 motores o 2 depósitos con una sola línea de combustible.



Conector Hembra

112306

Conector hembra YAMAHA/MARINER/MERCURY para línea de combustible lado motor y lado depósito.



Todos los conectores se adaptan a las mangueras de diámetro interior 7mm., 8mm. y 9mm.

Conector Hembra

112330

Conector hembra HONDA lado motor.



Conector Depósito

112313

Conector macho roscado MERCURY para depósito.



Conector Doble

112311

Conector macho MERCURY, con válvula, doble salida universal para utilizar con 2 motores o 2 depósitos con una sola línea de combustible.



Conector Macho

112314

Conector macho MERCURY para manguera combustible universal.



Conector Hembra

112310

Conector hembra MERCURY/MARINER lado motor.



Conector Hembra

112312

Conector hembra MERCURY/MARINER lado depósito.



Conector Macho

112317

Conector macho MERCURY/MARINER para manguera lado depósito.



Conector Hembra

112316

Conector hembra MERCURY para manguera lado motor tipo antiguo.



Conector Hembra

112315

Conector hembra roscado MERCURY para depósito.



Conector Hembra

112324

Conector hembra SUZUKI/CHRYSLER/FORCE para manguera lado motor.



Conector Hembra

112329

Conector hembra lado depósito MERCURY/MARINER.



Conector Depósito

112323

Conector macho SUZUKI/CHRYSLER/FORCE para depósito.



Conector Depósito

112322

Conector macho HONDA/SUZUKI/
TOHATSU/NISSAN para depósito.



Codo Manguera

188067

Fabricado en latón. Rosca 1/4" NPT
de 90° para manguera de 9mm.
(3/8").



Conector Macho

112318

Conector macho TOHATSU/NISSAN
para motor.



Conector Hembra

112321

Conector hembra TOHATSU/NISSAN
para manguera lado motor.



Conector Hembra

112319

Conector hembra SUZUKI lado
motor.



Conector Hembra

112320

Kit macho/hembra NISSAN para
depósito.



Codo Depósito

188063

Para motores Johnson/Evinrude.
Rosca 1/4" NPT.



Conector Hembra

112325

Conector hembra HONDA/SUZUKI
TOHATSU/NISSAN para manguera
lado depósito.



Conector Manguera

188088

Para motores Nissan/Tohatsu. Para
mangueras de 9mm. (3/8").



Conector Manguera

188056

Para motores Johnson/Evinrude.
Para mangueras de 8mm. (5/16").

188092

Para mangueras de 9mm. (3/8").





Conector Motor

188089

Para Motores Nissan/Tohatsu. Rosca métrica. Para mangueras de 9mm. (3/8").



Conector Macho

188070

Para motores Mercury/Mariner. Para manguera de 5/16" (8mm)

188084

Para mangueras de 9mm. (3/8").



Conector Macho

188078

Para motores Suzuki/Nissan/Tohatsu. Rosca 1/4" NPT.



Conector Depósito Hembra

188068

Para motores Mercury/Mariner. Para mangueras de 9mm. (3/8").

188082

Para mangueras de 6mm. (1/4").



Conector Hembra

188062

Para motores Suzuki/Chrysler. Para mangueras de 9mm. (3/8").



Conector Hembra

188079

Para motores Suzuki/Nissan/Tohatsu. Lado depósito. Para mangueras de 9mm. (3/8").



Conector Depósito

188087

Para motores Suzuki. Rosca métrica.

1880409

Para mangueras de 6mm. (1/4").



Conector Macho

188071

Conector pequeño para motores Suzuki/Chrysler/Force. Rosca 1/4" NPT.



Conector Depósito

188077

Para motores Mercury/Mariner/Yamaha. Para mangueras de 9mm. (3/8").



Conector Depósito

188090

Para motores Suzuki. Rosca 1/4" NPT



Conector Manguera

Para motores Mercury/Mariner/
Yamaha.

188075

Para manguera de 1/4" (6mm)

188085

Para manguera de 5/16" (8mm)

188076

Para manguera de 3/8" (9mm)



Conector de Combustible

1880404

Para motores Suzuki. Se ajusta a DF25-
DF 140 Hp. Para mangueras de 9mm.
(3/8").



Conector Hembra

188069

Para motores Mercury/Mariner. Para
manguera de 5/16" (8mm)



Conector de Combustible

1880402

Para motores Mercury/Mariner. 1/4"
NPT.

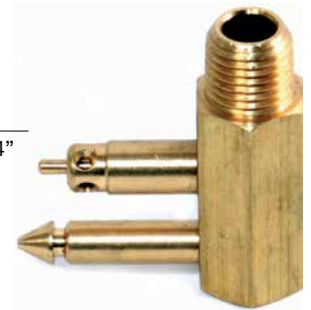

Conector de Combustible

1880400

Para motores Honda. Salida macho
1/4" latón. Conecta con Ref.
1880401



Conector de Combustible

1880408

Para motores Honda. Salida hembra de
8mm (5/16"). Con cierre rectangular. Se
ajusta a motores de último modelo.

1880403

Para mangueras de 9mm. (3/8").



Conector de Combustible

1880401

Para motores Honda. Salida hembra.
Manguera de 3/8". Conecta con Ref.
1880400.



Conector de Combustible

1880405

Para motores Suzuki. Salida hembra,
manguera de 3/8".



Filtros Combustible

112401

Elimina la introducción de elementos sólidos en el carburador. Fabricado en plástico transparente para inspección para motores de gasolina desde 2000cc. Hasta 3500cc.



112405

Elimina la introducción de elementos sólidos en el carburador. Fabricado en plástico transparente para inspección. Filtro 90° para motores de gasolina hasta 2000cc.



112406

Filtro recto para motores diésel de 2000cc. Hasta 3500cc. Fabricado en plástico transparente para su inspección.



112400

Elimina la introducción de elementos sólidos en el carburador. Fabricado en plástico transparente para inspección. Filtro recto para motores de gasolina hasta 2000cc.



112404

Filtro recto para motores diésel para más de 3500cc. Fabricado en plástico transparente para su inspección.



112402

Filtro recto para motores diésel hasta 2000cc. Fabricado en plástico transparente para su inspección.



112403

Filtro 90° para motores diésel hasta 2000cc. Fabricado en plástico transparente para su inspección.



112397

Filtro recto para motores diésel hasta 1500cc. Fabricado en plástico transparente para su inspección.



Filtros Separadores de Agua

Filtración 10 micras

508516

Mercury. Cabezal de aluminio



508518

Yamaha. Cabezal de aluminio



508517

Cabezal de aluminio



508519

Mercury. Cabezal de aluminio



Abrazaderas Inoxidables Norma

Abrazaderas a tornillo sin fin. Fleje ancho anticortante de 12mm (excepto Ref. 016734, y Ref. 016735 con eje de 9mm). Tornillo inox. Con cabeza hexagonal ranurada de 7mm. Fabricados, totalmente, en **Acero inoxidable AISI 316. W5.**



Referencia	Ø	Referencia	Ø
016734	8-16mm	016740	50-70mm
016735	12-20mm	016741	60-80mm
016736	20-32mm	016742	70-90mm
016750	25-35mm	016743	90-110mm
016737	24-40mm	016744	110-130mm
016738	35-50mm	016745	140-160mm
016739	40-60mm		

Otras medidas superiores, bajo demanda.

Filtros separadores de Agua Separ

Los separadores Separ aumentan la duración entre cambios de filtros, pudiendo considerarse aumentada la vida de éstos en tres o cuatro veces. Menor desgaste de bomba y del sistema de inyección. Óptima combustión del gasoil, redundando en una perfecta anticontaminación. Inferior consumo de gasoil. Menos costes de mantenimiento con una mas espaciada paralización para reparaciones. Funcionan sobre la base de un sistema de tres fases, filtrando todas las partículas sólidas y las impurezas líquidas que sean más pesadas que el propio gasoil, las cuales podrían causar problemas en el motor.

Como trabaja el separador de agua:

- **Primer cuerpo:** Separación de partículas sólidas hasta 30 micras y de las impurezas líquidas del carburante por medio de una acción centrífuga del propio separador.
- **Segundo cuerpo:** Captación de partículas muy pequeñas de hasta 15 micras. Estas diminutas partículas, en suspensión van con el gasoil y entran separador por su parte superior, quedan atrapadas en la superficie de entrada de la turbina. Las mayores y más pesadas fracciones van gradualmente siendo depositadas en el fondo del vaso transparente.
- **Tercer cuerpo:** Filtración de las mas pequeñas impurezas que el gasoil pueda contener a través del elemento filtrante incorporado al separador eliminado hasta las 2 micras, significando un porcentaje del 96%. La acción combinada de los tres cuerpos nos dan una separación del agua de un 100% de acuerdo a las normas **DIN 51777.**

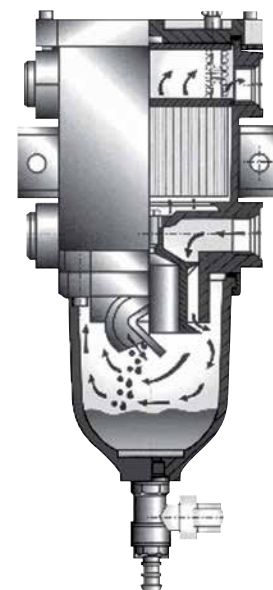

017020

Para motores caudal máximo 2 lts./min., hasta 100cv.

017021

Para motores caudal máximo 4lts./min., hasta 100cv.

017022

Para motores caudal máximo 6lts./min., hasta 100cv.

017023

Para motores caudal máximo 12lts./min., hasta 100cv.

Elementos filtrantes	
Referencia	Ref. Separ
017001	Separ-20
017002	Separ-50
017003	Separ-90
017004	Separ-100

Intercambios filtros Separ con filtros Rácord		
Referencia	Ref. Separ	Ref. Rácord
017020	KWA 20	200 FG
017021	KWA 50	500 FG
017022	KWA 90	900 FG
017023	KWA 100	1000 FG

Intercambios elementos filtrantes Separ con Racors		
Referencia	Ref. Separ	Ref. Rácord
017001	Separ-20	2000 TM
017002	Separ-50	2010 TM
017003	Separ-90	2040 TM
017004	Separ-00	2020 TM

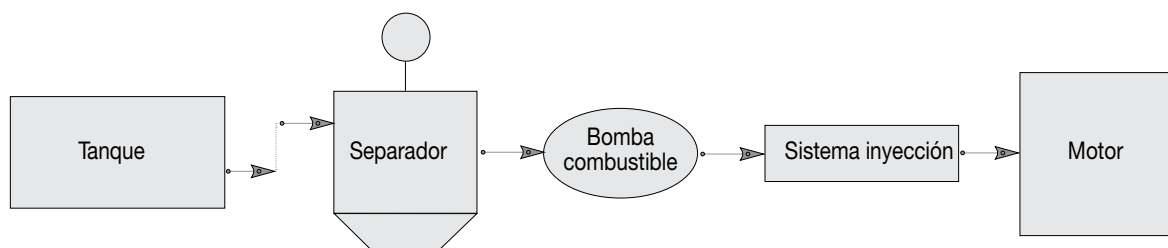

Bujías Champion



- Las bujías Champion cubre el 90% de aplicaciones del mercado con tan solo 10 referencias, tanto para intraborda como fuerabordas.
- Llevan un aislador patentado de alúmina, endurecido con circonio para alcanzar una dureza casi tan alta como el diamante. Las cinco nervaduras incrementan la rigidez en un 35%, previene contra el "flashover" y aseguran una mejor sujeción del capuchón de la bujía.
- El tipo de supresor de interferencias inductivo asegura la máxima energía de encendido entre los electrodos de la bujía y el tiempo de tensión más corto. Todo ello sin reducir la duración del arco. Garantiza la no interferencia del sistema de encendido ni con los componentes electrónicos del motor ni con los equipos de navegación.
- Cuerpo metálico con triple protección que proporciona la máxima resistencia a la corrosión y actúa facilitando el desmontaje de las bujías después de un prolongado tiempo de servicio. Rosca de precisión conforme a todos los estándares ISO y SAE según las especificaciones de todos los fabricantes de motores, para facilitar la instalación y desmontaje de las bujías.
- Ensamblaje con doble sellado.
- Electrodo central de masa con núcleo de cobre.



Artículo Proveedor	Referencia	Artículo Proveedor	Referencia	Artículo Proveedor	Referencia
CJ6	050947	QC8WEP	050977	RL82C	050924
CJ7Y	050956	QL16V	050911	RL82YC	050952
CJ8	050950	QL6VC	050912	RL82YCC	050941
J4C	050901	QL76V	050913	RL86C	050925
J6C	050902	QL77JC4	050914	RL87YC	050963
J8C	050903	QL78C	050915	RN11YC4	050970
L20V	050904	QL78V	050916	RN2C	050959
L6VC	050934	QL78YC	050917	RN3C	050960
L76V	050905	QL78YC6	050962	RN5C	050951
L77JC4	050906	QL82C	050966	RN7YC	050979
L78C	050907	QL82YC	050918	RN9LCC	050942
L78V	050908	QL86C	050919	RN9YC	050948
L78YC	050933	QL87YC	050920	RN9YCC	050944
L78YC6	050923	QN53VS	050921	RS12PYP	050978
L82C	050937	QN86	050922	RS12YC	050949
L82YC	050909	R15YC4	050982	RS14YC6	050972
L86C	050910	RA8HC	050957	RS9YC	050955
L86CC	050953	RC10ECC	050961	RV12C6	050926
L87YC	050938	RC10YCC	050965	RV12YC	050927
N2C	050939	RC12ECC	050967	RV15YC4	050928
N3C	050940	RC15YC4	050981	RV8C	050929
N6YC	050936	RC7PYCBX/012	050975	RV91MC	050973
N9YC	050969	RC9YC	050943	RV9YC	050930
P10Y	050958	RF10C	050935	UL18V	050931
P8Y	050964	RJ12YC	050980	UL77V	050932
QC10WEP	050976	RJ8C	050945	V63C	050946
QC12PEP	050974	RL78C	050954	V63CST/003	050971

Bujías NGK

- Las bujías NGK tienen un electrodo central con el núcleo de cobre insertado profundamente en la punta, para disipar rápidamente grandes cantidades de calor.
- Esta característica hace que esta bujía sea de un “rango térmico ultralimpio”, que resiste tanto el calentamiento como la suciedad.
- Incorpora un aislador producido con cerámica de alúmina de alta pureza de tecnología punta, resistiendo a los choques térmicos (calentamiento, y enfriamiento bruscos).
- Su sólida construcción, garantiza una excelente hermeticidad al gas.
- La punta del electrodo está fabricada con una aleación especial de níquel que asegura su durabilidad.



Artículo Proveedor	Referencia	Artículo Proveedor	Referencia	Artículo Proveedor	Referencia
AB6	050800	BPR6FS	050700	DCPR6E	050859
B5ES	050801	BPR6HS	050827	DCPR7E	050894
B5HS	050802	BPR7ES	050828	DCPR8E	050873
B6ES	050803	BPR7HS	050829	DPR5EA-9	050896
B6HS	050804	BPR7HS-10	050843	DPR6EA9	050865
B7ES	050805	BPR8ES	050861	DPR6EB-9	050887
B7HS	050806	BPZ8HN-10	050870	DPR8EA-9	050848
B7HS-10	050807	BPZ8HS-10	050842	DR5HS	050852
B8ES	050808	BPZ8HS-15	050863	DR6HS	050851
B8HS	050809	BR4HS	050830	DR7EA	050824
B8HS-10	050810	BR5HS	050892	DR8EA	050868
B9ES	050811	BR6EF	050706	DR8ES	050849
B9HS	050812	BR6ES	050705	DR8HS	050834
B9HS-10	050813	BR6FIX	050711	DR9EA	050858
BKR6E	050823	BR6FS	050831	IMR9D9H	050891
BKR7EKU	050899	BPR2ES	050707	IZFR5G	050876
BM6A	050814	BR6HS-10	050880	IZFR6F11	050875
BM6F	050815	BR7ES	050847	LFR4E	050895
BM7A	050816	BR7HS	050853	LFR5A-11	050862
BM7F	050817	BR7HS-10	050832	LFR6A-11	050881
BMR4A	050841	BR8ES	050833	PMR9B	050701
BP5ES	050818	BR8ES-11	050882	PZFR5F-11	050846
BP5HS	050855	BR8HS	050854	PZFR6H	050886
BP6ES	050819	BR8HS-10	050835	TR4	050879
BP6HS	050820	BR9ES	050836	TR5	050708
BP7EFS	050856	BR9HS-10	050837	TR55	050877
BP7ES	050821	BU8H	050838	TR55IX	050888
BP7HS	050822	BUHW	050839	TR6IX	050710
BP8H-N-10	050871	BUHW-2	050840	UR4	050878
BP8HS-15	050869	BZ7HS-10	050885	YR5	050709
BPMR7A	050850	CR5EH-9	050890	YR5IX	050712
BPR4ES-11	050864	CR5HS	050883	ZFR4F11	050872
BPR5ES	050825	CR6HS	050845	ZFR5E	050867
BPR5HS	050874	CR6HSA	050889	ZFR7E	050866
BPR6EFS	050857	CR8 EH-9	050860	ZFR7F	050702
BPR6ES	050826	CR9EB	050884		



HÉLICES BAEKSAN

Baeksan fabrica miles de hélices desde el año 1984. Nuestras helices de altas prestaciones fabricadas con los mejores materiales aseguran una larga vida y una navegación tranquila y sin sobresaltos.

Sus palas compensadas ofrecen una reducción significativa de la vibraciones.

Cojinete de goma insertado en el nucleo en versión fija o nucleo intercambiable.

Mano de pintura de alto grosor para evitar la corrosión.

En caso de no conocer la referencia original de la hélice a reemplazar siga los siguientes pasos:

- 1-Comprueba el rango de Revoluciones por minuto (RPM) del fabricante del motor en el manual.
- 2-Comprueba las RPM maximas del motor leyendo el panel para determinar el paso y velocidad optimo.
- 3-Si las RPM maximas exceden el rango recomendado, disminuye las RPM utilizando un paso superior.
- 4-Si las RPM son mas bajas que el rango recomendado, aumenta las RPM utilizando un paso inferior.

Si no localiza la hélice que necesita contacte con nuestro departamento técnico.

MERCUISER

Tipo	Colas	Referencia	Descripción	Ref. Original	Palas	Núcleo
E	<ul style="list-style-type: none"> • Caja de engranajes 4 3/4" • Para colas Mercruiser Alpha One y Bravo One Escape a través del núcleo, 15 estrias	62U1501613	16 x 13	48-78114a45	3	Intercambiable 62BHME
		62U150151415	15 1/4 x 15	48-78116A45	3	
		62U1501616	16 x16	48-16440A45	3	
		62U1351517	15x17	48-832828A45	3	
		62U150141219	14 1/2 x 19	48-832830A45	3	
		62U150141421	14 1/4 x 21	48-832832A45	3	
		62U1501423	14 x 23	48-832834A45	3	
		624U1501516	15 x 16	48-834850A45	4	
		624U1501516	14 1/2 X 18	48-834852A45	4	
F	Para colas Bravo 2 Escape a través del núcleo	62M300183417	18 3/4 x 17 LH	48-18613A40	3	Fijo
		62M300183417	18 3/4 x 17 RH	48-18615A40	3	
		62M300181419	18 1/4 x 19 LH	48-18615A40	3	
		62M300181419	18 1/4 x 19 RH	48-18614A40	3	
		62M300173421	17 3/4 x 21 LH	48-18617A40	3	
		62M300173421	17 3/4 x 21 RH	48-18616A40	3	
		62M300171223	17 1/2 x 23 LH	48-18619A40	3	
		62M300171223	17 1/2 x 23 RH	48-18618A40	3	

O.M.C

Tipo	Colas	Referencia	Descripción	Ref. Original	Palas	Núcleo
D	Modelo 400 <ul style="list-style-type: none"> • 2.3 L (120 hp) hasta 1991 • 2.5 L (120 hp) hasta 1978-1984 Cobra <ul style="list-style-type: none"> • 2.3 L (128 hp) 1988-1991 • 2.5 L (120 hp) 1985-1987 • 3.0 L (140 hp) 1985-1987 Escape a través del núcleo 13 estrias	62J701413	14 x 13	391668	3	Fijo
		62J70133415	13 3/4 x 15	391198	3	
		62J70131417	13 1/4 x 17	763463	3	
		62J701417	14 x 17	176214	3	
		62J70131419	13 1/4 x 19	763464	3	
E	Modelo 800 Cobra-King Cobra <ul style="list-style-type: none"> • 3.0L-8.2L(no colas SX)1990-1993 • Cobra 5.8L 1990-1993 • Sea Drive 2.0-4.0L Todos los años Escape a través del núcleo 15 estrias	62J150151213	15 1/2 x 13	763453	3	Fijo
		62J150151215	15 1/2 x 15	391535	3	
		62J1501517	15x17	391200	3	Intercambiable 62BHJE
		62U150151415	15 1/4 x 15	48-78116A45	3	
		62U1351517	15 x 17	48-832828A45	3	
		62U150141219	14 1/2 x 19	48-832830A45	3	
		62U150141421	14 1/4 x 21	48-832832A45	3	
		62U1501423	14x23	48-832834A45	3	
		624U1501516	15x 16	48-834850A45	4	
		624U150141218	14 1/2 x 18	48-834852A45	4	
624U1501420	14 x 20	48-834854A45	4			

YAMAHA

Tipo	Colas	Referencia	Descripción	Ref. Original	Palas	Núcleo
Y5	4-6 hp <ul style="list-style-type: none"> • 4 hp (2 tiempos)1986-1999 • F4hp (4 tiempos)1999-Posteriores • 5 hp (2 tiempos)1995-2002 • F6hp (4 tiempos.1 cil.) 2011-Posteriores Escape no a través del núcleo, 9 estrias	62Y57127	7 1/2 x7	6E0-45943-01-EL	3	Fijo
		62Y57128	7 1/2 x 8	6E0-45941-01-EL	3	
Y8	6-9 hp <ul style="list-style-type: none"> • 6 hp (2 tiempos) 1986-2000 • F6hp (4 tiempos.1 cil.)2001-2010 • 8 hp (2 tiempos)1986-2009 • F8hp (4 tiempos)2001-Posteriores • F9.9 hp (4 tiempos)2008-Posteriores Escape a través del núcleo, 7 estrias	62Y812812	8 1/2 x 8 1/2	6G1-45941-00-00	3	Fijo

YAMAHA

Tipo	Colas	Referencia	Descripción	Ref. Original	Palas	Núcleo
A	9.9 - 20 hp • 9.9hp (2 tiempos)1984-2009 • F9.9hp (4 tiempos)2000-2007 • 15hp (2 tiempos) 1984-2009 • F15hp (4 tiempos) 1998-Posteriores • F15C 2007-Posteriores • F20hp (4 tiempos) 2007-Posteriores. Escape a través del núcleo,8 estrias	62Y159148	9 1/4 x 8	683-45947-00-EL	3	Fijo
		62Y159149	9 1/4 x 9	683-45945-00-EL	3	
		62Y15914934	9 1/4 x 9 3/4	683-45952-00-EL	3	
		62Y159141012	9 1/4 x 10 1/2	683-45943-00-EL	3	
		62Y1591412	9 1/4 x 12	63V-45941-10 - EL	3	
B	20-30 hp • 20 hp 1996-1997 • 25 hp 1980-Posteriores • F25hp (4 tiempos) 1998-2006 • 30 hp 1983-200 Escape a través del núcleo,10 estrias	62Y309789	9 7/8 x 9	664-45941-01-EL	3	Fijo
		62Y309781012	9 7/8 x 10 1/2	664-45945-00-EL	3	
		62Y309781114	9 7/8 x 11 1/4	664-45947-01-EL	3	
		62Y3097812	9 7/8 x 12	664-45954-01- EL	3	
		62Y13097813	9 7/8 x 13	664-45949-02-EL	3	
		62Y3097814	9 7/8 x 14	664-45952-00-EL	3	
C	25-60 hp • T25hp 2010-Posteriores • F30 hp (4 tiempos)2001-2005 • 40 hp 1984-Posteriores • F40 hp (4 tiempos) 1999-Posteriores • 48 hp 1995-2000 • 50 hp (no T50) 1984- Posteriores • F50 hp (4 tiempos)1995-Posteriores • 55 hp 1976-1995 • 60 hp 1976-1991 • F60 hp (4 tiempos)1999-Posteriores Escape a través del núcleo,13 estrias	62Y4012149	12 1/4 x 9	663-45956-01- EL	3	Fijo
		62Y40113410	11 3/4 x 10	663-45954-01- EL	3	
		62Y40115811	11 5/8 x 11	663-45947-02- EL	3	
		62Y40105812	10 5/8 x 12	6H5-45945-00- EL	3	
		62Y401138x12	11 3/8 x 12	663-45952-02-EL	3	
		62Y40103813	10 3/8 x 13	6H5- 45945-00 - EL	3	
		62Y40111813	11 1/8 x 13	663-45945-02-EL	3	
		62Y40101414	10 1/4 x 14	6H5-45958-00-EL	3	
		62Y40111414	11 1/4 x 14	663-45958-01-EL	3	
		62Y401115	11x 15	69W-45943-00-EL	3	
		62U4012149	14 1/4 x 9		3	Intercambiable 62BHYC
		62U40113410	11 3/4 x 10		3	
		62U40115811	11 5/8 x 11		3	
		62U40113812	11 3/8 x 12		3	
		62U40111813	11 1/8 X 13		3	
		62U40111414	11 1/4 x 14		3	
		62U40105812	10 5/8 x 12		4	
		62U40103813	10 3/8 x 13		4	
		62U40101814	10 1/8 x 14		4	
		62U40101815	10 1/8 X 15		4	
E40G, EK40G		62PY40113410	11 3/4 x 10	676-45945-62-EL	3	Fijo
		62PY40111211	11 1/2x 11	676-45941-62-EL	3	
D	50-130hp • T50hp 1996-Posteriores • T60hp 2003-Posteriores • 60hp 1992-Posteriores • 70hp 1984-Posteriores • F70hp(4 tiempos)2003-Posteriores • 75hp 1994-Posteriores • 80hp 1997 • F80hp(4 tiempos)1999-2002 • 85hp 1991-1997 • 90hp 1984-Posteriores • F90hp(4 tiempos)1999-Posteriores • F100hp(4 tiempos)1999-2002 • 115hp 1984-Posteriores • F115hp(4 tiempos)2000-Posteriores • 130hp 1984-2003 Escape a través del núcleo,15 estrias *Usar núcleo intercambiable 62BHYD en los mot. 50-100 hp *Usar núcleo intercambiable 62BHYE en los mot. 115-130 hp	62Y60135813	13 5/8 x 13	6E5-45949-00 - EL	3	Fijo
		62Y60131215	13 1/2 x 15	6E5- 45947-00- EL	3	
		62Y85131417	13 1/4 x 17	6E5-45945-01-EL	3	
		62Y851319	13 x 19	6E5-45941-00-EL	3	
		62Y85125821	12 5/8 x 21	6E5-45943-00- EL	3	
		62U601410	14 x 10	48- 854342A45	3	
		62U901411	14 x 11	48-77338A45	3	intercambiable 62BHYD o 62BHYE
		62U901413	14 x 13	48-77340A45	3	
		62U60133415	13 3/4 x 15	48-77342A45	3	
		62U90131417	13 1/4 x 17	48-77344A45	3	
		62U901319	13 x 19	48-77346A45	3	
		62U90123421	12 3/4 x 21	48-77348A45	3	
		62U90137811	13 7/8 x 11	8M8026560	4	
		62490137813	13 7/8 X 13	8M8026570	4	
		624U90133815	13 3/8 x 15	8M8026580	4	
		624U901317	13x 17	8M8026590	4	
		624U90121219	12 1/2 x 19	8M8026600	4	

YAMAHA

Tipo	Colas	Referencia	Descripción	Ref. Original	Palas	Núcleo
E	150-300HP • 150hp 1986-Posteriores • 150hp(4 tiempos)2004-Posteriores • 175hp 1984-Posteriores • 200hp 1984-Posteriores • 200hp(VMAX)2001 • 220hp(Special)1984-1985 • 225hp(Excel)1987-1988 • 225hp 1986-Posteriores • 250hp 1990-Posteriores • 250hp(VMAX)2001 • F200hp(4 tiempos)2002-Posteriores • F225hp(4 tiempos)2002-Posteriores • 300hp 2003-Posteriores • 300hp HPDI 2004-Posteriores Escape a través del núcleo,15 estrias No utilizar 150-300hp 4 tiempos y SHO	62Y150151415	15 1/4 x 15	6G5-45941-01-98	3	Núcleo Fijo
		62Y150141217	14 1/2 x 17	6G5-45947-01-98	3	
		62Y1501419	14 x 19	6G5-45945-01-98	3	
		62Y150133421	13 3/4 x 21	6G5-45943-01-98	3	
		62Y150131823	13 1/2 x 23	6G5-45949-00-98	3	
		62U1501613	16 x 13	48-78114A45	3	Núcleo intercambiable 62BHYE
		62U150151415	15 1/4 x 15	48-78116A45	3	
		62U1501616	16 x 16	48-16440A45	3	
		62U1351517	15 x 17	48-832828A45	3	
		62U150141219	14 1/2 x 19	48-832830A45	3	
		62U150141421	14 1/4 x 21	48-832832A45	3	
		62U1501423	14 x 23	48-832834A45	3	
		624U1501516	15 x 16	48-834850445	4	
		624U150141218	14 1/2 x 18	48-834852A45	4	
		624U1501420	14 x 20	48-8348584A45	4	

MERCURY / MARINER

Tipo	Colas	Referencia	Descripción	Ref. Original	Palas	Núcleo
M5	4-6 hp • 4 hp 1987-Posteriores • 5 hp (2 tiempos) 1987-Posteriores • 6 hp (4 tiempos) 1999-Posteriores Escape a través del núcleo,12 estrias	62M57788	7 7/8 x 8	48-812950A02	3	Fijo
A	6-15 hp • 6,8,9.9hp (2 tiempos)1986-Posteriores • 8,9.9hp (4 tiempos) 1995-2004 • 10 hp 1995-Posteriores • 15 hp (2-4 tiempos)1989-Posteriores • No motores Bigfoot Escape a través del núcleo,8 estrias	62M159147	9 1/4 x 7	48-828152A12	3	Fijo
		62M1598	9 x 8	48-828154A12	3	
		62M1599	9 x 9	48-828156A12	3	
B	9.9-25 hp • 9.9hp (Bigfoot,4 tiempos)1999-2005 • 18hp Mercury 1980-1985 • 20hp (2 tiempos) Mercury 1986-2002 • 25hp (2 tiempos) Mercury 1980-2005 • 25hp (2 tiempos) Mariner 1985-Posteriores • 25hp (Sea Pro,Marathon)Todos los años Escape a través del núcleo,10 estrias	62M25103811	10 3/8 x 11	48-19638A40	3	Fijo
		62M25103813	10 3/8 x 13	48-19640A40	3	

En caso de no identificar la hélice que necesite,
 contacte con el departamento de recambios:
recambios@pronautic.net

MERCURY / MARINER

C	25-70 hp <ul style="list-style-type: none"> Modelos 402,500,700, 1977-1984 25hp (Bigfoot 4 tiempos)1999-2005 30hp (2-4 tiempos) 1994-2005 35hp 1984-1989 40hp(2-4 tiempos,no bigfoot)1997-Post. 45hp 1986-1989 48hp(Mariner)Todos los años 50hp(2-4 tiempos,no Bigfoot)1977-Post. 55hp 1995-Posteriores 60hp(2 tiempos) 1978-Posteriores 60hp(4 tiempos,no Bigfoot)2001-Post. 70hp hasta 1983 Escape a través del núcleo,13 estrias	62M5512149	12 1/4 x 9	48-87818A10	3	Fijo
		62M55121012	12 x 10 1/2	48-42740A10	3	
		62M55111410	11 1/4 x 10	48-73132A40	3	
		62M55107811	10 7/8 x 11	48-85623A40	3	
		62M40105812	10 5/8 x 12	48-73134A40	3	
		62M40103813	10 3/8 x 13	48-73136A40	3	
		62M40101213	10 1/2 x 13	48- 816704A40	3	
		62M40101414	10 1/4 x 14	48-73138A40	3	
		62M40103814	10 3/8 x 14	48-816706A40	3	
		62M40101815	10 1/8 x 15	48-73140A45	3	
		62U4012149	12 1/4 x 9		3	Intercambiable 62BHMC
		62U40113410	11 3/4 x 10		3	
		62U40115811	11 5/8 x 11		3	
		62U40113812	11 3/8 x 12		3	
		62U40111813	11 1/8 x 13		3	
		62U40111414	11 1/4 x 14		3	
		62U40105812	10 5/8 x 12		4	
		62U40103813	10 3/8 x 13		4	
		62U40101814	10 1/8 x 14		4	
		62U40101815	10 1/8 x 15		4	

Tipo	Colas	Referencia	Descripción	Ref. Original	Palas	Núcleo
------	-------	------------	-------------	---------------	-------	--------

D	40-140hp <ul style="list-style-type: none"> 40-50hp(4 tiempos,Bigfoot)Todos años 70hp 1987-1989 75hp(2-4 tiempos)1984-Posteriores 40-50hp(4 tiempos,Bigfoot)Todos años 60hp(4 tiempos,Bigfoot)1995-Posteriores 80hp 1978-1989 90hp (2-4 tiempos)1978-Posteriores 100hp 1988-Posteriores 115hp 1978-Posteriores 115hp(4 tiempos)2001-Posteriores 125hp 1994-Posteriores 140hp 1978-1981 650(4 cilindros)1961-1970 650(2 cilindros)hasta 1971 800,850(6 cilindros)hasta 1972 800,850(4 cilindros)1972-1977 900-1500 hasta 1977 Escape a través del núcleo, 15 estrias	62U601410	14x 10	48-854342A45	3	Intercambiable 62BHMD
		62U901411	14x11	48-77338A45	3	
		62U901413	14x 13	48-77340A45	3	
		62U60133415	13 3/4 x 15	48-77342A45	3	
		62U90131417	13 1/4 x 17	48- 77344A45	3	
		62U901319	13 x 19	48- 77346A45	3	
		62U90123421	12 3/4 x 21	48-77348A45	3	
		624U90137811	13 7/8 x 11	8M8026560	4	
		624U90137813	13 7/8 x 13	8M8026570	4	
		624U90133815	13 3/8 x 15	8M8026580	4	
		624U901317	13 x 17	8M8026590	4	
		624U90121219	12 1/2 x 19	8M8026600	4	

E	90-275 hp <ul style="list-style-type: none"> 90-115hp 2014-Posteriores 135hp 1987-Posteriores 150hp 1978-Posteriores 175-225hp 1978-Posteriores 250hp 1994-Posteriores 275hp 1990-1994 Para colas Mercruiser: Alpha I,Bravo I caja engr. 3/4" Escape a través del núcleo,15 estrias	62U1501613	16 x 13	48-78114A45	3	Intercambiable 62BHME
		62U150151415	15 1/4 x 15	48- 78116A45	3	
		62U1501616	16 x 16	48- 16440A45	3	
		62U1501517	15 x 17	48- 832828A45	3	
		62U150141219	14 1/2 x 19	48- 832830A45	3	
		62U150141421	14 1/4 x 21	48- 832832A45	3	
		62U1501423	14 x 23	48-832834A45	3	
		624U1501516	15 x 16	48- 834850A45	4	
		624U150141218	14 1/2 x 18	48- 834852A45	4	
		624U1501420	14 x 20	48- 834854A45	4	

SUZUKI

Tipo	Colas	Referencia	Descripción	Ref. Original	Palas	Núcleo
A	8-20 hp • DF 8A(4 tiempos) 2011-Posteriores • DT 9.9 1983-1987 • DF 9.9(4 tiempos)1996-Posteriores • DF 9.9A/9.9B(4 tiempos)2010-Posteriores • DT15 1983-1988 • DT15C 1989-1997 • DT15 (4 tiempos) 1996-Posteriores • DF 15A/20A(4 tiempos) 2013-Posteriores Escape a través del núcleo,10 estrias	62S159149	9 1/4 x 9	58100-94J00-019	3	Fijo
		62S1591410	9 1/4 x 10	58100-93733-019	3	
		62S1591411	9 1/4 x 11	58100-93743-019	3	
		62S1591412	9 1/4 x 12		3	
		62S15F9149	9 1/4 x 9	58100-89L20-019	3	
		62S15F91410	9 1/4 x 10	58100-89L30-019	3	
		62S15F91411	9 1/4 x 11	58100-89L40-019	3	
		62S15F91412	9 1/4 x 12	58100-89L50-019	3	
B	20-30 hp • DT20 1987-1988 • DT25 1987-1988 • DT25C 1989-2000 • DF25 (4 tiempos)2000-Posteriores • DF25R 2010-Posteriores • DF25A 2014-Posteriores • DT30,30C 1987-1997 • DF 30 (4 tiempos)2000-2007 • DF 30A 2014-Posteriores • Para motores Johnson/Evinrude: • 25hp (4 tiempos)2004-Posteriores • 30hp (4 tiempos)2004-Posteriores Escape a través del núcleo,10 estrias	62S3010149	10 1/4 x 9	58100-96371-019	3	Fijo
		62S30101410	10 1/4 x 10	58100-96410-019	3	
		62S30101411	10 1/4 x 11	58100-96420-019	3	
		62S30101412	10 1/4 x 12	58100-96430-019	3	
		62S30101413	10 1/4 x 13	58100-96440-019	3	
		62S30101414	10 1/4 x 14	58100-95D00-019	3	
		62S30101415	10 1/4 x 15	58100-96460-019	3	

SUZUKI

Tipo	Colas	Referencia	Descripción	Ref. Original	Palas	Núcleo
C	35-65hp • DT35C 1987-1989 • DT40 1983-1998 • DF40, 40A(4 tiempos)1999-Posteriores • DT50, 50M 1983-1984 • DF50, 50A(4 tiempos,no 50AV)2010-Post. • DT55 1985-1997 • DT60 1983-1984 • DF60A (4 tiempos,no 60AV)2010-Post. • DT65 1985-1997 • Para motores Johnson/Evinrude: • 40hp (4 tiempos) 1999-Posteriores • 50hp (4 tiempos) 1999-Posteriores Escape a través del núcleo,13 estrias	62S40111211	11 1/2 x 11	58100-95222- 019	3	Fijo
		62S40111212	11 1/2 x 12	58100-95393-019	3	
		62S40111213	11 1/2 x 13	58100-9413-019	3	
		62S40111214	11 1/2 x 14	58100-95353-019	3	
		62S40111415	11 1/4 x 15	58100-95363-019	3	
		62S40111816	11 1/8 x 16	58100-88L71-019	3	
		Intercambiable 62BHSJC	62S401117	11 x 17	58100-88L81-019	3
			62U4012149	12 1/4 x 9		3
			62U40113410	11 3/4 x 10		3
			62U40115811	11 5/8 x 11		3
			62U40113812	11 3/8 x 12		3
			62U40111813	11 1/8 x 13		3
			62U40111414	11 1/4 x 14		3
			624U40105812	10 5/8 x 12		4
			624U40103813	10 3/8 x 13		4
624U40101814	10 1/8 x 14		4			
62AU40101815	10 1/8 x 15		4			
D	60-140 hp • DF60 (4 tiempos)1998-2009 • DF70 (4 tiempos)1998-2008 • DT75 1983-1997 • DT85 1979-2000 • DT90 1989-1997 • DT100 1989-2000 • DT115 1981-2001 • DT140 1981-2001 Escape a través del núcleo,13 estrias	62S60131215	13 1/2 x 15	58100-94500-019	3	Fijo
		62S60131417	13 1/4 x 17	58100-94512-019	3	

SUZUKI

E	50-140 hp - 4 tiempos • DF 50AV (4 tiempos)2015-Posteriores • DF 60AV (4 tiempos)2015-Posteriores • DF 70A (4 tiempos)2009-Posteriores • DF 80A (4 tiempos)2009-Posteriores • DF90 (4 tiempos) 2001-2008 • DF90A (4 tiempos) 2009-Posteriores • DF100 (4 tiempos)2009- Posteriores • DF115 (4 tiempos) 2001-2012 • DF115A (4 tiempos)2013-Posteriores • DF140(4 tiempos) 2002-2012 • DF140A (4 tiempos) 2013-Posteriores Escape a través del núcleo,15 estrias	62S901415	14 x 15	58100-90J41-019	3	Fijo
		62S901417	14 x 17	58100-90J01- 019	3	
		62S901418	14 x 18		3	
		62S901419	14 x 19	58100-90J11-019	3	
		62S901421	14 x 21	58100-90J21- 019	3	

TOHATSU / NISSAN

Tipo	Colas	Referencia	Descripción	Ref. Original	Palas	Núcleo
T8	8-9.8 hp • 8hp (2 tiempos)Todos los años • 8hp MFS8 (4 tiempos)Todos los años • 8hp NSF8 (4 tiempos)Todos los años • 9.8hp (2 tiempos)Todos los años • 9.8hp MFS9.8(4 tiempos)Todos los años • 9.8hp NSF9.8(4 tiempos)Todos los años • Para motores Mercury: • 8hp (4 tiempos)2005-Posteriores Escape a través del núcleo,12 estrias	62T88127	8 1/2 x 7	3B2-64513-0	3	Fijo
		62T88128	8 1/8 x 8	3B2B64515-1	3	
A	9.9-18hp • 9.9hp 1984-Posteriores • 9.9hp (4 tiempos)2000-Posteriores • 12hp 1985-1988 • 15hp (4 tiempos)2000-Posteriores • 15,18hp 1985-Posteriores • 18hp (4 tiempos)2001-Posteriores • Escape a través del núcleo, 14 estrias	62T159148	9 1/4 x 8	3BAB64516-0	3	Fijo
		62T159149	9 1/4 x 9	3B4B64518-0	3	
		62T15914934	9 1/4 x 9 3/4		3	
		62T1591410	9 1/4 x 10	362-64108-0	3	
		62T159141012	9 1/4 x 10 1/2	3BAB64521-0	3	
		62T1591412	9 1/4 x 12		3	
B	25-30hp • 25hp 1986-Posteriores • 30hp 1985-Posteriores • Para motores Mercury: • 25hp (4 tiempos)2006-Posteriores • 30hp (4 tiempos)2006-Posteriores • Escape a través del núcleo,10 estrias	62T309789	9 7/8 x 9	3R0B64518-0	3	Fijo
		62T3097810	9 7/8 x 10	3R0B64521-0	3	
		62T3097811	9 7/8 x 11	3R0B64523-0	3	
		62T3097812	9 7/8 x 12	3R0B64525-0	3	
		62T3097813	9 7/8 x 13	3R0B64527-0	3	
		62T309781414	9 7/8 x 14 1/4	349B64529-1	3	

En caso de no identificar la hélice que necesite,
 contacte con el departamento de recambios:
recambios@pronautic.net

TOHATSU / NISSAN

C	35-50 hp • 35hp (solo 35B)hasta 1984 • 40hp 1984-Posteriores • MFS40 2015-Posteriores • 50hp 1992-Posteriores • MFS50 2015-Posteriores • BFT60 2014-Posteriores	62T4012149	12 1/4 x 9	3T5B64518-0	3	Fijo
		62T40113410	11 3/4 x 10		3	
		62T40115811	11 5/8 x 11	3T5B64523-0	3	
		62T40113812	11 3/8 x 12	3T5B64525-0	3	
		62T40111813	11 1/8 x 13	3T5B64527	3	
		62T40111414	11 1/4 x 14	3T5B64529-0	3	
		62T401115	11 x 15	3T5B64532-0	3	
		62U4012149	12 1/4 x 9		3	
	Escape a través del núcleo, 13 estrias	62U40113410	11 3/4 x 10		3	Intercambiable 62BHTC
		62U40115811	11 5/8 x 11		3	
		62U40113812	11 3/8 X 12		3	
		62U40111813	11 1/8 x 13		3	
		62U40111414	11 1/4 X 14		3	
		624U40105812	10 5/8 x 12		4	
		624U40103813	10 3/8 x 13		4	
		624U40101814	10 1/8 x 14		4	
50-70hp • 50hp (solo 50C)1987-1991 • 55hp 1981-1988 • 60A-60B 1986-1999 • 70A-70B 1981-1995 Escape a través del núcleo,13 estrias	62U48121213	12 1/2 x 13		3	Intercambiable 62BHTC48	
	62U48121415	12 1/4 x 15		3		
D	60-140hp • 60C(Caja engranajes grande)hasta 1999 • 70C(Caja engranajes grande)Todos los años • 90hp 1987-2001 • 115hp 1992-Posteriores • 120hp 1988-2003 • 140hp 1988-2003 • Se adaptan a los nuevos modelos de motor • Tohatsu D Escape a través del núcleo,15 estrias	62T90135813	13 5/8 x 13	3N4B64527-1	3	Fijo
		62T90131215	13 1/2 x 15	3N4B64532-1	3	
		62T90131417	13 1/4 x 17	3N4B64536-1	3	
		62T901319	13 x 19	3N4B64541-1	3	
		62T90125821	12 5/8 x 21	3N4B64545-1	3	Intercambiable 62BHTD
		62U601410	14 x 10	48-854342A45	3	
		62U901411	14 x 11	48-77338A45	3	
		62U901413	14 x 13	48-77340A45	3	
		62U60133415	13 3/4 x 15	48-77342A45	3	
		62U90131417	13 1/4 x 17	48-77344A45	3	
		62U901319	13 x 19	48-77344A45	3	
		62U90123421	12 3/4 x 21	48-77348A45	3	
		624U90137811	13 7/8 x 11	8M8026560	4	
		624U90137813	13 7/8 x 13	8M8026570	4	
		624U90133815	13 3/8 x 15	8M8026580	4	
		624U901317	13 x 17	8M8026590	4	
4U90121219	12 1/2 x 19	8M8026600	4			

HONDA

Tipo	Colas	Referencia	Descripción	Ref. Original	Palas	Núcleo
A	8-15 hp • BF8 2000-Posteriores • BF9.9 1988-Posteriores • BF15 Todos años Escape a través del núcleo,8 estrias	62H159148	9 1/4 x 8	58130-ZV4-008AH	3	Fijo
		62H159149	9 1/4 x 9	58130-ZV4-009AH	3	
		62H15914934	9 1/4 x 9 3/4		3	
		62H159141012	9 1/4 x 10 1/2	58130-ZVA- 010AH	3	
		62H1591412	9 1/4 x 12		3	
B	25-30 hp • BF25 todos los años • BF30 Todos los años Escape a través del núcleo,10 estrias	62H309789	9 7/8 x 9	58130-ZV7-009AH	3	Fijo
		62H3097810	9 7/8 x 10	58130-ZV7-010AH	3	
		62H3097811	9 7/8 x 11	58130-ZV7-011AH	3	
		62H3097812	9 7/8 x 12	58130-ZV7-012AH	3	
		62H3097813	9 7/8 x 13	58130-ZV7-013AH	3	
		62H309781414	9 7/8 x 14 1/4		3	

HONDA

C	35-50 hp • BF35 1991-1994 • BF40 1995-Posteriores • BF45 1991-1994 • BF50/50A 1995-Posteriores • BF60/60A 2010-Posteriores Escape a través del núcleo,13 estrias	62H4012149	12 1/4 x 9	58130-ZV5-009AH	3	Fijo
		62H40113410	11 3/4 x 10		3	
		62H40115811	11 5/8 x 11	58130-ZV5-011AH	3	
		62H40113812	11 3/8 x 12	58130-ZV5-012AH	3	
		62H40111813	11 1/8 x 13	58130-ZV5-013AH	3	
		62H40111414	11 1/4 x 14	58130-ZV5-014AH	3	
		62H401115	11 x 15	58130-ZV5-015AH	3	
		62U4012149	12 1/4 x 9		3	Intercambiable 62BHHC
		62U40113410	11 3/4 x 10		3	
		62U40115811	11 5/8 x 11		3	
		62U40113812	11 3/8 x 12		3	
		62U40111813	11 1/8 x 13		3	
		62U40111414	11 1/4 X 14		3	
		62U40105812	10 5/8 x 12		4	
		62U40103813	10 3/8 x 13		4	
62U40101814	10 1/8 x 14		4			
62U40101815	10 1/8 x 15		4			
D	75-130hp • BFP60 2009-Posteriores • BF75 1995-Posteriores • BF90 1995-Posteriores • BF115 1998-Posteriores • BF130 1998-Posteriores Escape a través del núcleo,15 estrias Para 75-90 hp 1995-1998 usar kit 62BHMD Para 75-90 hp 1999-Posteriores y 115-130hp 1998-posteriores usar kit 62BHHD	62U601410	14 x 10	48-854342A45	3	Intercambiable 62BHHD
		62U901411	14 x 11	48-77338A45	3	
		62U901413	14 x 13	48-77340A45	3	
		62U60133415	13 3/4 x 15	48-77342A45	3	
		62U90131417	13 1/4 x 17	48-77344A45	3	
		62U901319	13 x 19	48-77346A45	3	
		62U90123421	12 3/4 x 21	48-77348A45	3	
		62U90137811	13 7/8 x 11	8M8026560	4	
		62U90137813	13 7/8 x 13	8M8026570	4	
		62U90133815	13 3/8 x 15	8M8026580	4	
		62U901317	13 x 17	8M8026590	4	
62U90131319	12 1/2 x 19	8M8026600	4			
E	135-225hp • BF135-BF150 2004-Posteriores • BF200-BF225(4 tiempos)2002-Posteriores Escape a través del núcleo,15 estrias	62U1501613	16 x 13	48-78114A45	3	Intercambiable 62BHHE
		62U150151415	15 1/4 x 15	48-78116A45	3	
		62U1501616	16 x 16	48-16440A45	3	
		62U1351517	15 x 17	48-832828A45	3	
		62U150141219	14 1/2 x 19	48-832830A45	3	
		62U150141421	14 1/4 x 21	48-832832A45	3	
		62U1501423	14 x 23	48-832834A45	3	
		62U1501516	15 x 16	48-834850A45	4	
		62U150141218	14 1/2 X 18	48-834852A45	4	
62U1501420	14 x 20	48-834854A45	4			

EVINRUDE / JOHNSON / O.M.C

Tipo	Colas	Referencia	Descripción	Ref. Original	Palas	Núcleo
A	9.9-15 hp • 9.9-15hp 1974-Posteriores • 8-9,9-15hp(4 tiempos)1995-Posteriores Escape a través del núcleo, 13 estrias	62J1591210	9 1/2 x 10	778772	3	Fijo
B	20-35 hp • 20hp(2 cilindros) 1984-1997 • 25hp(2-3 cilindros)1984-Posteriores • 25hp(comercial)1993-Posteriores • 30hp(2 cilindros)1984-Posteriores • 35hp(2-3 cilindros)1973-Posteriores Escape a través del núcleo,14 estrias	62J251013	10 x 13	778863	3	Fijo
		62J251015	10 x 15	763486	3	

EVINRUDE / JOHNSON / O.M.C

C	40-50hp • 40hp(4 tiempos)1999-2005 • 50hp(4 tiempos)1999-2005 Escape a través del núcleo,13 estrias	62U4012149	12 1/4 x 9		3	Intercambiable 62BHSJC
		62U40113410	11 3/4 x 10		3	
		62U40115811	11 5/8 x 11		3	
		62U40113812	11 3/8 x 12		3	
		62U40111813	11 1/8 13		3	
		62U40111414	11 1/4 x 14		3	
		624U40105812	10 5/8 x 12		4	
		624U40103813	10 3/8 x 13		4	
		624U40101814	10 1/8 x 14		4	
		624U40101815	10 1/8 x 15		4	
D	40-75 hp • 40hp(2 cilindros)1984-Posteriores • 48hp 1987-1996 • 50hp 1975-Posteriores • 60hp(2 cilindros)1980-1985 • 75hp(3 cilindros)1975-1985 Escape a través del núcleo,13 estrias	62J48121213	12 1/2 x 13	763461	3	Fijo
		62J48121415	12 1/4 x 15	778774	3	
		62U48121213	12 1/2 x 13		3	Intercambiable 62BHJC48
		62U48121415	12 1/4 x 15		3	
D	40-140hp • Motores de 2 tiempos:40hp(E-Tec)2004-Post. • 45hp (2 cilindros comercial)1986-Posteriores • 50hp (E-Tec)2004-Posteriores • 50hp (2 cilindros comercial)1977-1979 • 50hp (2 cilindros)1971-1974 • 50hp (3 cilindros)1994-Posteriores • 55hp (2 cilindros comercial)1980-Posteriores • 55hp (3 cilindros) 1968-1969 • 60hp (3 cilindros)1970-71,1986-Posteriores • 60hp (E-Tec)2004-Posteriores • 65hp (3 cil.comercial)1984-Posteriores • 65hp (3 cilindros)1972-1973 • 70hp (3 cilindros)1974-Posteriores • 75hp (3 cilindros)1975-1984 • 75hp (E-Tec)2004-Posteriores • 85hp 1969-1980,1991-1995,88hp 1981-96 • 90hp 1981-Post., 90hp (E-Tec) 2004-Post. • 100hp 1979-80, 1988-93,110hp 1986-89 • 112hp 1994-96,115hp 1973-Post. • 115hp(E-Tec)2004-Post.,120hp 1986-94, • 125hp 1971-72,130hp (E- Tec)2004-Post. • 135hp 1973-76,140hp 1977-1994 • Motores de 4 tiempos: 60hp 1998-Post., • 70hp 1998-Post.,90hp 2003-Post., • 115hp 2003-Post.,140hp 2003-Post. • Colas: Modelo 400:2.3L(120hp)hasta 1991 • 2.5L (120hp)1978-1984,3.0L (140hp) hasta 1989 • Cobra: 2.3L (128hp)1988-1991, • 2.5L (120hp)1985-1987,3.0L (140hp)1985-1987 Escape a través del núcleo,13 estrias	62J701413	14 x 13	391668	3	Fijo
		62J70133415	13 3/4 x 15	391198	3	
		62J70131417	13 1/4 x 17	763463	3	
		62J701417	14 x 17	176214	3	
		62J70131419	13 1/4 x 19	763464	3	

En caso de no identificar la hélice que necesite,
 contacte con el departamento de recambios:
recambios@pronautic.net

EVINRUDE / JOHNSON / O.M.C

Tipo	Colas	Referencia	Descripción	Ref. Original	Palas	Núcleo		
E	90-300hp • Motores de 2 tiempos: 90hp 1995-Post., • 90hp (E-Tec extra grande) 2004-Post., • 100hp (comercial) 1984-Post., 115hp 1995-Post. • 120-140hp 1985,130hp 1995-Post., 140hp 1989-94 • 150hp (comercial) 1993-Post., 150hp 1978-Post., • 155hp (comercial) 1978-Posteriores, 175hp 1977-Post. • 185hp 1984-85,200hp 1976-Post., 225hp 1986-Post., • 235hp 1978-85,250hp 1991-Post., 275hp 1986-88, • 300hp 1986-95,2.6L 1984-85,3.6L 1986-87 • Colas: Cobra-King Cobra: 3.0L,8.2L(no SX)1990-93 • Cobra 5.8L 1990-1993, Sea Drive 2.0-4.0L Todos años Escape a través del núcleo, 15 estrias	62J150151213	15 1/2 x 13	763453	3	Fijo		
		62J150151215	15 1/2 x 15	391535	3			
		62J1501517	15 x 17	391200	3			
				62U150151415	15 1/4 x 15	48-78116A45	3	Intercambiable 62BHJE
				62U1351517	15 x 17	48-832828A45	3	
				62U150141219	14 1/2 x 19	48-832830A45	3	
				62U150141421	14 1/4 x 21	48-832832A45	3	
				62U1501423	14 x 23	48-832834A45	3	
				624U1501516	15 x 16	48-834850A45	4	
				624U150141218	14 1/2 x 18	48-834852A45	4	
				624U1501420	14 x 20	48-834854A45	4	

VOLVO















Hélices DuoProp. Se suministran por parejas. Fabricadas de aluminio.

Modelo	Ref. Original	Referencia	Contenido
A-3	854766	6924279	Hélice frontal de 3 palas y posterior de 4 palas
A-4	854767	6924270	
A-5	854768	6924271	
A-6	854769	6924272	
A-7	854770	6924273	
A-9		6924280	
B-3	854816	704013	Hélice frontal y posterior de 3 palas
B-4	854817	6924283	
B-5	854818	6924275	
B-6	854819	6924276	
B-7	854820	6924277	
B-9		6924284	

HÉLICES PARA TRANSMISIONES SX

Aplicación	Referencia	Diametro x paso	Referencia original	Palas	Nucleo	
• 3.0L 1994-Posteriores • 4.3L 1994-Posteriores • 5.0L 1994-Posteriores • 5.7L 1994-Posteriores • 5.8L 1994-1997 • 7.4L 1997-Posteriores • 8.2L 1997 Escape a través del núcleo, 19 estrias	62SX151213	15 1/2 x 13	3840720	3	Fijo	
	62SX151215	15 1/2 x 15	3817466	3		
	62SX1517	15 x 17	3817467	3		
		62U150151415	15 1/4 x 15	48-78116A45	3	Intercambiable 62BHSX
		62U1351517	15 x 17	48-832828A45	3	
		62U150141219	14 1/2 x 19	48-832830A45	3	
		62U150141221	14 1/2 x 21	48-832832A45	3	
		62U1501423	14 x 23	48-832834A45	3	
		624U1501516	15 x 16	48-834850A45	4	
		624U150141218	14 1/2 x 18	48-834852A45	4	
		624U1501420	14 x 20	48-834854A45	4	

TIPOS DE NÚCLEOS INTERCAMBIABLES

Tipo	Modelo	Contenido	Tipo	Modelo	Contenido	
C	62BHYC / YAMAHA		D	62BHYD / YAMAHA		
	62BHMC / MERCURY			62BHMD / MERCURY		
	62BHSJC / SUZUKI-EVINRUDE-JOHNSON			62BHHD / HONDA		
	62BHTC / TOHATSU			62BHTD / TOHATSU		
	62BHHC / HONDA			E	62BHYE / YAMAHA	
	62BHJC48 / JOHNSON				62BHME / MERCURY	
	62BHTC48 / TOHATSU				62BHHE / HONDA	
	SX	62BHSX / SX DRIVE				62BHJE / EVINRUDE (JOHNSON)

62BHMD y 62BHME son lo mismo.



HERRAMIENTA PARA EL DIAGNOSIS DE MOTORES

MOTO DE AGUA, FUERABORDA E INTRABORDA EN UNA ÚNICA HERRAMIENTA DE DIAGNOSIS MULTIMARCA.

- Intuitiva y rápida.
- Conexión inalámbrica bluetooth.

DIAGNOSIS AVANZADA

- Lectura y borrado de errores.
- Autodetección de sistemas.
- Calibraciones motor, frenos, suspensión, trimado.
- Parametrizaciones.
- Memorización de llaves.

SISTEMAS

- Motor.
- Control de timón.
- Control de colas.
- Tren de propulsión.
- Frenos y marcha atrás.
- Instrumentación

INFORMACIÓN TÉCNICA

- Localización de conectores.
- Esquemas eléctricos.
- Datos técnicos del sistema.
- Datos de mantenimiento

ACTUALIZACIONES PERIÓDICAS

- Nuevos modelos, sistemas, información técnica y esquemas.
- Acceso directo a actualizaciones a través del software de diagnosis.

GRP (Garage Resource Planning)

- Software de gestión de taller.
- Gestión de clientes y reparaciones.
- Histórico.
- Creación de informes

SERVICIOS

- Asistencia técnica.
- Atención al cliente.
- Formación.



COBERTURA JALTEST MARINE:

MOTO DE AGUA:	INTRABORDA:
KAWASAKI	CATERPILLAR
SEADOO (BRP)	CRUSADER
YAMAHA	CUMMINS
<i>Próximamente...</i>	MAN
HSR-BENELLI,	MERCURY
HONDA	MERCUISER
FUERABORDA:	MERCURY RACING
EVINRUDE	MTU
HONDA	PCM
JOHNSON	SEADOO (BRP)
MARINER	VM MOTORI
MERCURY	VOLKSWAGEN
MERCURY RACING	VOLVO PENTA
NISSAN	YANMAR
SELVA	<i>Próximamente...</i>
SUZUKI	CUMMINS
TOHATSU	MERCUISER DIESEL.
YAMAHA	WEBER



Máquina Diagnosis Multimarca "JALTEST" FULL		<i>Este equipo no incorpora los cables: kit multipuntas, cummins, Carterpillar, Mtu y Man,</i>	
149001	STARTER KIT	149062	PRECIO CABLES KIT INTRABORDA
Incluye interface link, usb cable, maleta, cable alimentación, cable adaptador multipuntas, multipuntas tipo 1,2, 3,4,7		149008	Cable Mercury 4 Pins
149026	PRECIO ACTIVACIÓN SOFTWARE FULL MARINE	149009	Cable Mercury 10 Pins (mefi 1-4)
<i>Este equipo no incorpora los cables: kit multipuntas, cummins, Carterpillar, Mtu y Man,</i>		149010	Cable Volvo Penta Diesel
149007	PRECIO BOAT KIT CABLES	149013	Cable Volvo Penta EGC 6 Pins
149019	Cable Yamaha	149014	Cable Yanmar 3 pins
149008	Cable Mercury 4 Pins	149016	Cable Mercury 2 Pins
149009	Cable Mercury 10 Pins (MEFI 1-4)	149050	Cable DTS Mercury/Mercruiser
149010	Cable Volvo Penta Diesel	149051	Cable Volvo Penta KAD/KAMD/TAMD
149011	Cable Honda/ Tohatsu	149061	RENOVACION LICENCIA DE USO ANUAL KIT INTRABORDA
149012	Cable Evinrude	149049	PC JALTEST TOUGHBOOK
149013	Cable Volvo Penta EGC 6 Pins	149000	SOPORTE TÉCNICO
149014	Cable Yammar 3 Pins	Máquina Diagnosis Multimarca "JALTEST" FUERABORDA	
149015	Cable Suzuki 8 pins	149001	STARTER KIT
149016	Cable Mercury 2 Pins	Incluye interface link, usb cable, maleta, cable alimentación, cable adaptador multipuntas, multipuntas tipo 1,2, 3,4,7	
149017	Cable Suzuki 4 Pins	149057	ACTIVACION SOFTWARE KIT FUERABORDA
149050	Cable DTS Mercury/Mercruiser	<i>Este equipo no incorpora los cables: kit multipuntas, cummins, Carterpillar, Mtu y Man,</i>	
149051	Cable Volvo Penta KAD/KAMD/TAMD	149053	PRECIO CABLES KIT FUERABORDA
149018	KIT CABLES MOTOS DE AGUA SIN YAMAHA	149019	Cable Yamaha
149020	Cable BRP Seadoo (incluye Adap. Programador Llave)	149008	Cable Mercury 4 Pins
149021	Cable Kawasaki 4 Pins	149011	Cable Honda/ Tohatsu
149022	Cable Kawasaki 6 Pins Alimentacion	149012	Cable Evinrude
149023	Cable BRP Seadoo Programador Llaves	149015	Cable Suzuki 8 pins
149024	Adaptador Yamaha Programador Mandos	149016	Cable Mercury 2 Pins
149025	Adaptador Kawasaki Programador Llaves	149017	Cable Suzuki 4 Pins
149028	PRECIO RENOVACIÓN LICENCIA ANUAL FULL MARINE	149050	Cable DTS Mercury/Mercruiser
149049	PC JALTEST TOUGHBOOK	149058	RENOVACION LICENCIA DE USO ANUAL KIT FUERABORDA
149000	SOPORTE TÉCNICO	149049	PC JALTEST TOUGHBOOK
Máquina Diagnosis Multimarca "JALTEST" BARCOS		149000	SOPORTE TÉCNICO
149001	STARTER KIT	Máquina Diagnosis Multimarca "JALTEST" MOTOS DE AGUA	
Incluye interface link, usb cable, maleta, cable alimentación, cable adaptador multipuntas, multipuntas tipo 1,2, 3,4,7		149001	STARTER KIT
149032	ACTIVACION SOFTWARE KIT BARCOS	Incluye interface link, usb cable, maleta, cable alimentación, cable adaptador multipuntas, multipuntas tipo 1,2, 3,4,7	
<i>Este equipo no incorpora los cables: kit multipuntas, cummins, Carterpillar, Mtu y Man,</i>		149035	ACTIVACION SOFTWARE KIT JET SKI
149007	PRECIO BOAT KIT CABLES	<i>Este equipo no incorpora los cables: kit multipuntas, cummins, Carterpillar, Mtu y Man,</i>	
149019	Cable Yamaha	149065	PRECIO JET SKI CABLES
149008	Cable Mercury 4 Pins	149019	Cable Yamaha
149009	Cable Mercury 10 Pins (MEFI 1-4)	149020	Cable BRP Seadoo (incluye Adap. Programador Llave)
149010	Cable Volvo Penta Diesel	149021	Cable Kawasaki 4 Pins
149011	Cable Honda/ Tohatsu	149022	Cable Kawasaki 6 Pins Alimentacion
149012	Cable Evinrude	149023	Cable BRP Seadoo Programador Llaves
149013	Cable Volvo Penta EGC 6 Pins	149024	Adaptador Yamaha Programador Mandos
149014	Cable Yammar 3 Pins	149025	Adaptador Kawasaki Programador Llaves
149015	Cable Suzuki 8 pins	149037	RENOVACION LICENCIA DE USO ANUAL JET SKI
149016	Cable Mercury 2 Pins	149049	PC JALTEST TOUGHBOOK
149017	Cable Suzuki 4 Pins	149000	SOPORTE TÉCNICO
149050	Cable DTS Mercury/Mercruiser	Cables adicionales	
149051	Cable Volvo Penta KAD/KAMD/TAMD	149029	Cable Cummins
149034	RENOVACION LICENCIA DE USO ANUAL BARCOS	149030	Cable Caterpillar
149049	PC JALTEST TOUGHBOOK	149054	Cable MTU
149000	SOPORTE TÉCNICO	149055	Cable MAN
Máquina Diagnosis Multimarca "JALTEST" INTRABORDA		149031	Cable OBD VW HYUNDAI
149001	STARTER KIT		
Incluye interface link, usb cable, maleta, cable alimentación, cable adaptador multipuntas, multipuntas tipo 1,2, 3,4,7			
149059	ACTIVACION SOFTWARE KIT INTRABORDA		

GLM		GLM		GLM		GLM	
GLM N°.	Sierra N°.	GLM N°.	Sierra N°.	GLM N°.	Sierra N°.	GLM N°.	Sierra N°.
1056	18-7315	12103	18-3391	12733	18-6027	13440	18-3670
1070	18-7314	12104	18-3390	12736	18-6025	13450	18-3669
1073	18-7307	12105	18-3211	12737	18-6095	13520	18-3678
1100	18-7316	12106	18-3210	12738	18-6026	13530	18-1993
10561	18-3290	12107	18-3215	12739	18-6115	13540	18-3531
10562	18-3566	12108	18-3201	12740	18-6012	13550	18-3532
11013	18-2408	12110	18-3317	12741	18-6029	13950	18-8112
11020	18-2409	12120	18-3320	12743	18-6113	13984	18-4461
11030	18-2286	12130	18-3321	12744	18-6097	13990	18-4224
11040	18-2130	12140	18-3314	12745	18-6034	13991	18-4227
11050	18-2348	12150	18-3316	12750	18-6013	13992	18-4226
11051	18-2398	12170	18-3322	12760	18-3121	13993	18-4218
11052	18-2399	12180	18-3323	12770	18-6020	14010	18-4500
11055	18-1502	12190	18-3386	12772	18-6019	14020	18-4505
11060	18-2202	12200	18-3219	12773	18-6101	14030	18-4515
11061	18-2236	12202	18-3220	12774	18-6028	14040	18-4520
11071	18-3293	12210	18-3378	12775	18-6103	14060	18-4535
11091	18-2406	12211	18-3380	12776	18-6024	14110	18-4510
11100	18-2410	12221	18-3385	12780	18-6000	14115	18-4010
11110	18-2167	12243	18-3994	12781	18-6023	14120	18-4545
11120	18-2180	12244	18-3388	12782	18-6004	14125	18-4011
11130	18-2179	12246	18-3387	12784	18-6005	14130	18-4525
11131	18-2324	12250	18-3207	12787	18-6009	14135	18-4012
11140	18-2261	12251	18-3400	12788	18-6010	14140	18-4560
11150	18-2166	12260	18-3252	12789	18-6001	14145	18-4013
11151	18-2239	12270	18-3239	12810	18-3114	14155	18-4014
11155	18-2166	12280	18-3517	12812	18-3358	14160	18-4575
11163	18-2181	12290	18-3217	12813	18-3179	14165	18-4015
11190	18-3719	12305	18-3149-1	12817	18-3113	14190	18-4090
11200	18-6350	12310	18-3417	12820	18-3109	14210	18-3918
11210	18-2201	12320	18-3420	12821	18-3226	14220	18-3919
11215	18-2256	12330	18-3421	12822	18-3197	14230	18-3920
11216	18-2358	12341	18-2354	12824	18-3151	14240	18-3921
11220	18-2203	12350	18-3416	12825	18-3222	14250	18-3922
11225	18-2257	12352	18-3445	12826	18-2722	14260	18-3923
11226	18-2364	12360	18-3419	12829	18-3221	14270	18-3924
11230	18-2204	12370	18-3414	12830	18-3110	14275	18-3927
11235	18-2258	12380	18-3422	12836	18-2728	14280	18-3925
11236	18-2365	12390	18-3119	12840	18-3106	14315	18-4600
11238	18-6353	12391	18-3145	12860	18-3115	14320	18-4555
11240	18-2205	12395	18-3405	12880	18-3346	14330	18-4565
11245	18-2259	12400	18-3129	12881	18-6070	14410	18-4635
11246	18-2363	12405	18-3206	12883	18-6112	14430	18-4637
11300	18-2200	12410	18-3116	12884	18-6091	14440	18-4636
11312	18-2407	12415	18-3571	12885	18-6090	14470	18-4626
11380	18-2299	12416	18-3572	12886	18-6036	14480	18-4627
11381	18-2298	12420	18-3118	12887	18-6032	14490	18-4628
11405	18-2191	12430	18-3130	12888	18-6098	14600	18-4055
11406	18-1702	12440	18-3363	12889	18-6033	14610	18-4056
11410	18-1158	12450	18-3336	12920	18-2707	14640	18-4059
11416	18-1708	12460	18-3180	12930	18-2715	14650	18-4060
11420	18-1157	12470	18-3367	13010	18-3553	14660	18-4623
11430	18-1356	12500	18-3122	13020	18-3550	14670	18-4624
11500	18-2171	12501	18-3350	13030	18-3551	14680	18-4625
11510	18-2173	12502	18-3351	13040	18-3555	14910	18-3979
11520	18-2172	12510	18-3117	13050	18-3552	14920	18-3980
11610	18-5967	12520	18-3107	13060	18-3554	14930	18-3981
11620	18-2372	12540	18-3139	13070	18-3558	14940	18-3982
11800	18-8210	12550	18-3127	13080	18-3557	14950	18-3983
11810	18-8211	12560	18-3126	13100	18-3649	14960	18-3984
12000	18-3315-2	12590	18-3141	13101	18-3647	15100	18-3575
12010	18-3507	12610	18-3178	13120	18-3549	15201	18-3583
12020	18-3423	12620	18-3343	13124	18-3569	15201	18-3599
12030	18-3424	12630	18-3359	13150	18-3561	15301	18-3574
12041	18-3151	12670	18-6011	13170	18-3500	15400	18-3584
12042	18-3214	12675	18-6068	13200	18-3556	15500	18-3581
12043	18-3154	12680	18-6014	13220	18-1977-1	15600	18-3582
12050	18-3327	12690	18-6249	13230	18-1994	15700	18-3578
12060	18-3383	12700	18-6015-9	13270	18-3673	16100	18-4035
12061	18-3401	12702	18-6093	13280	18-3674	16120	18-4036
12070	18-3382	12703	18-6067	13350	18-3672	16150	18-4037
12071	18-3381	12703	18-6114	13370	18-3650	16180	18-1186
12082	18-3216	12704	18-6089	13380	18-3646	16200	18-1194
12084	18-3237	12704	18-6092	13380	18-3651	16210	18-4038
12085	18-3309	12710	18-6016	13381	18-3662	16220	18-1374
12088	18-3150	12711	18-6080	13390	18-3668	16230	18-1376
12091	18-3212-1	12712	18-6094	13400	18-3652	16240	18-1375
12100	18-3324	12713	18-6066	13410	18-3671	16300	18-1366
12101	18-3393	12730	18-6017	13420	18-3667	16310	18-1371
12102	18-3392	12731	18-6018	13430	18-3653	16320	18-1367

*Para localizar el número de página, consulte el índice / referencia de la página 750 a 781

GLM		GLM		GLM		GLM	
GLM N°.	Sierra N°.	GLM N°.	Sierra N°.	GLM N°.	Sierra N°.	GLM N°.	Sierra N°.
16330	18-1365	21511	18-1179	22120	18-3742	22750	18-1112
16340	18-1370	21512	18-1129	22130	18-3743	22760	18-1113
16350	18-1363	21520	18-1160	22140	18-3744	22770	18-1114
16360	18-1364	21540	18-1161	22150	18-3705	22780	18-1115
16370	18-1368	21541	18-1170	22160	18-3706	22800	18-1352
16400	18-4039	21542	18-1172	22170	18-3707	22810	18-1353
16420	18-1195	21543	18-1171	22185	18-3708-1	22820	18-1361
16470	18-1347	21560	18-1142	22190	18-4231	22830	18-1378
16520	18-1196	21570	18-1164	22191	18-4274	22840	18-1359
17000	18-2402	21580	18-1143	22200	18-3715	22850	18-1360
18000	18-2401	21584	18-1193	22220	18-4223	22860	18-1350
18100	18-2443	21590	18-1159	22230	18-4222	22870	18-1351
19100	18-2450	21591	18-1173	22240	18-4230	22880	18-1357
19200	18-2451	21592	18-1130	22250	18-4228	22890	18-1354
19300	18-2452	21593	18-1197	22252	18-4194	22900	18-1355
19310	18-3729	21600	18-1150	22260	18-4232	22910	18-1358
19350	18-3728	21610	18-1117	22280	18-0550	22920	18-1372
19400	18-2453	21620	18-1155	22290	18-0549	22930	18-1373
21010	18-2154	21622	18-1346	22300	18-2377	22940	18-1369
21015	18-2353	21623	18-1345	22317	18-4244	22960	18-1118
21020	18-2155	21625	18-1398	22320	18-3153	22980	18-1121
21030	18-2150	21630	18-1162	22321	18-4276	22990	18-1122
21031	18-2320	21641	18-0193	22322	18-4277	23010	18-2778
21032	18-0647	21642	18-0195	22323	18-3133	23011	18-2777
21033	18-0655	21643	18-0194	22325	18-3365	23020	18-2939
21040	18-2193	21644	18-0198	22330	18-3725	23030	18-2199
21060	18-2164	21645	18-0200	22340	18-3717	23040	18-4210
21070	18-2165	21646	18-0199	22350	18-3716	23050	18-4213
21080	18-2141	21647	18-0196	22360	18-3369	23060	18-4214
21090	18-2163	21648	18-0197	22370	18-3135	23070	18-4211
21100	18-2151	21649	18-0201	22380	18-3136	23080	18-2153
21110	18-3750	21710	18-2157	22388	18-0653	23090	18-4204
21111	18-3768	21711	18-2145	22390	18-0190	23100	18-4206
21120	18-3751	21715	18-2245-1	22391	18-3233	23110	18-2194
21130	18-2152	21725	18-4236	22407	18-9219	23140	18-2342
21131	18-2357	21731	18-2375	22408	18-2279	23141	18-3759
21136	18-4295	21731	18-23751-9	22409	18-2277	23150	18-4208
21140	18-2161	21731	18-2378	22410	18-2185	23160	18-4209
21160	18-3720	21731	18-23781-9	22411	18-2184	23200	18-2346
21161	18-2344	21740	18-3245	22412	18-2183	23203	18-7296
21170	18-3721	21740	18-6245	22413	18-2186	23210	18-2294
21180	18-3722	21750	18-2170	22414	18-2187	23220	18-2285
21190	18-3723	21770	18-4289	22416	18-2252	23230	18-4215
21210	18-3200	21771	18-2345	22417	18-2251	23240	18-4212
21220	18-3204	21780	18-2160	22420	18-2244	23260	18-2283
21230	18-3700	21790	18-7321	22420	18-2241-9	23261	18-2282
21231	18-3737	21791	18-7311	22420	18-2387	23270	18-2293
21240	18-3704	21800	18-4267	22420	18-23871-9	23280	18-2292
21241	18-3726	21811	18-2140	22421	18-2288	23300	18-2295
21242	18-3703	21820	18-1156	22430	18-2361	23510	18-2231
21245	18-0654	21830	18-1166	22433	18-2326	23580	18-2230
21250	18-3701	21840	18-1153	22435	18-2327	23590	18-2229
21251	18-3782	21850	18-2101	22436	18-2330	23710	18-3931
21260	18-3702	21860	18-1154	22440	18-3229	23800	18-4122
21261	18-3781	21870	18-3199	22445	18-8551	23810	18-4121
21290	18-4233	21880	18-3198	22490	18-2243	23810	18-4294
21300	18-4220	21885	18-1500	22491	18-1501	23820	18-4112
21321	18-8348	21887	18-8111	22500	18-4040	23830	18-4111
21330	18-7426	21890	18-3232	22520	18-1600	23840	18-4102
21350	18-4221	21892	18-4258	22540	18-1602	23850	18-4101
21360	18-3714	21893	18-4263	22560	18-1601	23910	18-4107
21370	18-2462	21894	18-4264	22612	18-2217	23930	18-4127
21380	18-2463	21896	18-4265	22616	18-2290	23940	18-4123
21419	18-3749	21900	18-2100	22620	18-2217	23950	18-4113
21420	18-2169	21910	18-2461	22625	18-2216	23960	18-4103
21421	18-2322	21930	18-2148	22630	18-2221	24010	18-4120
21423	18-3236	21951	18-8205	22631	18-2218	24020	18-4110
21424	18-2395	21960	18-8206	22633	18-2220	24030	18-4100
21425	18-2464	21961	18-8212	22661	18-2310	24040	18-4124
21430	18-2149	21962	18-2771	22662	18-2309	24050	18-4065
21432	18-3754	21980	18-2142	22663	18-2308	24060	18-4114
21433	18-2303	22010	18-2176	22670	18-2210	24080	18-4104
21440	18-2600	22020	18-2177	22671	18-2207	24090	18-4067
21450	18-2603	22030	18-4251	22672	18-2208	24100	18-4066
21451	18-2190	22031	18-4273	22673	18-2209	24110	18-4125
21453	18-2604	22040	18-2156	22681	18-2289	24112	18-4115
21460	18-2159	22050	18-2178	22683	18-2287	24130	18-4105
21480	18-2396	22090	18-2380	22700	18-1362	24140	18-4068
21481	18-2397	22100	18-3740	22710	18-1377	24210	18-3904
21510	18-1165	22110	18-3741	22720	18-1099	24240	18-3910

GLM		GLM		GLM		GLM	
GLM N°.	Sierra N°.	GLM N°.	Sierra N°.	GLM N°.	Sierra N°.	GLM N°.	Sierra N°.
24250	18-3975	28180	18-1152	30900	18-0133	31740	18-0434
24260	18-3911	28190	18-1151	30920	18-0928	31750	18-0158
24280	18-3912	28300	18-3231	30930	18-2512	31770	18-0903
24290	18-3974	28310	18-2125	30940	18-0932	31780	18-0942
24300	18-3905	28315	18-2146	30960	18-0101	31790	18-0137
24310	18-3913	28317	18-2337	30970	18-0866	31810	18-2804
24330	18-3915	28318	18-2339	30980	18-0372	31820	18-0685
24410	18-4106	28325	18-2338	30990	18-0103	31830	18-0389
24430	18-3933	28330	18-3712	31000	18-0938	31840	18-2843
24430	18-4126	28340	18-6400	31010	18-2914	31850	18-0365
24570	18-3907	28350	18-3752	31020	18-2915	31860	18-2800
24590	18-3908	28360	18-3713	31030	18-2801	31870	18-0369
24830	18-7826	28370	18-0577	31040	18-2826	31880	18-0151
24840	18-7859	28380	18-2296	31050	18-2919	31890	18-2507
24841	18-7869	28390	18-4296	31060	18-2823	31900	18-0147
24880	18-7860	28400	18-2381	31070	18-2824	31900	18-0747
24900	18-7861	28402	18-2382	31080	18-2825	31910	18-0105
24910	18-7862	30010	18-2340	31090	18-2827	31920	18-2805
24930	18-7846	30020	18-0681	31100	18-0872	31930	18-2836
24940	18-7845	30030	18-2316	31100	18-2949	31940	18-0934
24941	18-7844	30050	18-0123	31101	18-2902	31950	18-2837
24950	18-7852-1	30060	18-0870	31105	18-8536	31960	18-0371
24951	18-7848-1	30090	18-2564	31110	18-2829	31970	18-0373
24970	18-7854	30100	18-0328	31120	18-2847	31980	18-0139
24980	18-7855	30120	18-0329	31130	18-2820	31990	18-0936
25000	18-7853-1	30160	18-0895	31141	18-2743	32000	18-2561
25110	18-8207	30170	18-0333	31150	18-0894	32010	18-2500
25115	18-2404	30180	18-0334	31160	18-2840	32030	18-5399
25120	18-8208	30190	18-1209	31170	18-29451-9	32040	18-0422
25125	18-2405	30220	18-0672	31171	18-42481-9	32050	18-2839
25135	18-2369	30230	18-0893	31180	18-2948	32070	18-0946
26030	18-2119	30240	18-0897	31190	18-2841	32080	18-2849
26040	18-2105	30260	18-2810	31200	18-2828	32090	18-2504
26050	18-2106	30270	18-2809	31210	18-2560	32100	18-2555
26060	18-2107	30290	18-2563	31220	18-2558	32110	18-0385
26070	18-2108	30290	18-2566	31230	18-2559	32120	18-2803
26080	18-2109	30300	18-4380	31260	18-2568	32130	18-0357
26090	18-2120	30320	18-2565	31270	18-2569	32140	18-0360
26100	18-2103	30330	18-0344	31280	18-2570	32150	18-2502
26110	18-2112	30350	18-0464	31300	18-2571	32160	18-0667
26120	18-2113	30351	18-1238	31310	18-2567	32170	18-2909
26130	18-2110	30353	18-0428	31330	18-4261	32175	18-8533
26140	18-2111	30353	18-2845	31340	18-0164	32180	18-0994
26170	18-2123	30354	18-0322	31350	18-0327	32190	18-2575
26180	18-2124	30357	18-0664	31360	18-0889	32200	18-2910
26190	18-2114	30359	18-0311	31370	18-0874	32210	18-0347
26200	18-2134	30360	18-0887	31380	18-0891	32220	18-0320
26200	18-2137	30363	18-0740	31390	18-0332	32280	18-2574
26210	18-2116	30370	18-0905	31400	18-0879	32300	18-0948
26220	18-2126	30380	18-2848	31410	18-2819	32320	18-2807
26240	18-2115	30381	18-0435	31420	18-1210	32330	18-0952
26250	18-2136	30390	18-0419	31430	18-2831	32350	18-0384
26310	18-2701	30410	18-0867	31440	18-2830	32360	18-2562
26320	18-2336	30430	18-2514	31450	18-2846	32370	18-0111
26330	18-2702-1	30440	18-0980	31460	18-2553	32390	18-0185
26340	18-4288	30450	18-0350	31470	18-0342	32400	18-0160
26350	18-2341	30470	18-0352	31480	18-0885	32420	18-2505
26380	18-2428	30480	18-0982	31490	18-2832	32440	18-2808
26400	18-2427	30490	18-0898	31500	18-2802	32450	18-2510
26410	18-2426	30510	18-0353	31510	18-2844	32460	18-0113
26440	18-0652	30530	18-0976	31520	18-2833	32470	18-0881
26460	18-2425	30570	18-0904	31530	18-0378	32480	18-0950
26470	18-2424	30580	18-0354	31540	18-0462	32500	18-0388
26480	18-2465-9	30610	18-0182	31550	18-2896	32510	18-2511
26490	18-2466-9	30640	18-0910	31560	18-2917	32520	18-2506
26500	18-2420	30670	18-0129	31570	18-2912	32530	18-2503
26510	18-2421	30680	18-2806	31580	18-2515	32540	18-2508-1
26520	18-2423	30700	18-0912	31590	18-0568	32560	18-0945
26530	18-2422	30720	18-0914	31600	18-2838	32580	18-0114
27700	18-3767	30730	18-0149	31620	18-2834	32600	18-0318
27720	18-1731	30740	18-0359	31630	18-2554	32630	18-0954
27782	18-1712	30760	18-0918	31640	18-0988	32640	18-2815
27931	18-2192	30770	18-0131	31650	18-2572	32650	18-7106
27940	18-1729	30790	18-0410	31660	18-0356	32680	18-0431
28020	18-2104	30800	18-0922	31670	18-2552	32730	18-0386
28030	18-2174	30850	18-4366	31680	18-2501	32740	18-0916
28040	18-2097	30860	18-0868	31690	18-2509	32750	18-0876
28050	18-9218	30870	18-0363	31710	18-0992	32760	18-0323
28060	18-6401	30880	18-0926	31720	18-2835	32770	18-0324
28100	18-2128	30890	18-2513	31730	18-2573	32780	18-0336

*Para localizar el número de página, consulte el índice / referencia de la página 750 a 781

GLM		GLM		GLM		GLM	
GLM N°.	Sierra N°.	GLM N°.	Sierra N°.	GLM N°.	Sierra N°.	GLM N°.	Sierra N°.
32800	18-2343	33830	18-2961	34910	18-3827	37100	18-2991
32820	18-0339	33840	18-2947	34920	18-3829	37110	18-0962
32830	18-0670	33850	18-2884	34930	18-3830	37120	18-0869
32840	18-0341	33860	18-2888	34940	18-3831	37130	18-0154
32870	18-0930	33870	18-2964	34950	18-3805	37150	18-0960
32880	18-0135	33880	18-3804	34960	18-3832	37160	18-0417
32890	18-0374	33890	18-3828	34970	18-0959	37190	18-0968
32920	18-0380	33900	18-0548	34980	18-0961	37200	18-0119
32930	18-0940	33910	18-0884	34990	18-0967	37210	18-0853
32940	18-0944	33930	18-0104	35020	18-2929	37220	18-0855
32950	18-0107	33950	18-0913	35030	18-0391	37240	18-0857
32960	18-0970	33960	18-0880	35060	18-0398	37250	18-0861
32980	18-2850	33970	18-0440	35070	18-0346	37260	18-0141
32990	18-2883-1	34000	18-0679	35070	18-0349	37270	18-0152
33010	18-2851	34010	18-3841-2	35080	18-2971	37290	18-0863
33020	18-0110	34020	18-2889	35090	18-2729	37310	18-0873
33030	18-0430	34030	18-2959	35180	18-0983	37320	18-0314
33050	18-0939	34040	18-2891	35190	18-0112	37330	18-0115
33060	18-2863	34050	18-2892	35200	18-0120	37360	18-0958
33080	18-2907	34080	18-0850	35320	18-0122	37370	18-0915
33090	18-2862	34090	18-2893	35330	18-0126	37400	18-0315
33100	18-2890	34120	18-0882	35340	18-0128	37410	18-0854
33110	18-2879	34140	18-2963	35360	18-0136	37430	18-0415
33120	18-2908	34150	18-2895	35370	18-0138	37470	18-0622
33130	18-2903	34200	18-2897	35380	18-0140	37490	18-0345
33140	18-2906	34220	18-2881	35390	18-0142	37500	18-0416
33150	18-2709	34230	18-0917	35400	18-0144	37520	18-0624
33170	18-2901	34240	18-3801	35410	18-0441	37530	18-0644
33180	18-2867	34250	18-3802	35420	18-0851	37540	18-0645
33190	18-2904	34260	18-0929	35430	18-1205	37550	18-0646
33210	18-2887	34280	18-3836	35440	18-1202	37560	18-0642
33220	18-2880	34290	18-2866	35460	18-0150	37570	18-0643
33230	18-2871	34300	18-0117	35480	18-0157	37590	18-0641
33240	18-2870	34310	18-2543	35540	18-0161	37630	18-2942
33250	18-0426	34320	18-2853	35620	18-0633	37640	18-2621
33280	18-2876	34330	18-0969	35650	18-3898	37650	18-2741
33330	18-2861	34340	18-0971	35730	18-0978	37660	18-2740
33340	18-2860	34350	18-2878	35740	18-0130	37670	18-2943
33370	18-2900	34370	18-2544	35750	18-0987	37680	18-2611
33400	18-2960	34380	18-0979	35780	18-0965	37690	18-2610
33410	18-2865	34390	18-0981	35800	18-0963	37760	18-2582
33420	18-2855	34400	18-3837	35830	18-3895	37795	18-0626
33430	18-2877	34410	18-0189	35840	18-2954	37796	18-0628
33440	18-2858	34420	18-0975	35850	18-3861	37797	18-0627
33450	18-2874	34430	18-0989	35860	18-3862	39010	18-4386
33460	18-0973	34440	18-0675	35870	18-3864	39020	18-4387
33470	18-0947	34450	18-2547	35880	18-3863	39030	18-4385
33480	18-0949	34460	18-2550	35890	18-3871	39040	18-4381
33500	18-0677	34470	18-0995	35900	18-3872	39050	18-4383
33510	18-0955	34480	18-0997	35930	18-3866	39060	18-4384
33511	18-0108	34490	18-0999	35940	18-3896	39080	18-4303-1
33530	18-2873	34520	18-0124	35950	18-3838	39090	18-4304-1
33540	18-2956	34530	18-1212	35960	18-3897	39100	18-4358
33560	18-2856	34540	18-0134	35990	18-2957	39110	18-4382
33570	18-1204	34550	18-2865	36080	18-2968	39120	18-4397
33580	18-0680	34560	18-3360	36090	18-2970	39130	18-0340
33590	18-2545	34570	18-3803	36100	18-3879	39140	18-4350
33600	18-2546	34580	18-2905	36100	18-7879-1	39150	18-4351
33610	18-0148	34590	18-3839	36110	18-3877	39160	18-0407
33620	18-2549	34610	18-2913	36120	18-3878	39170	18-0465
33630	18-0985	34620	18-2938	36130	18-3880	39180	18-4352
33640	18-2864	34630	18-2548	36140	18-3881	39190	18-4353
33650	18-0977	34640	18-0933	36150	18-2946	39210	18-4354
33660	18-0991	34650	18-0927	36160	18-3876	39230	18-0153
33680	18-0102	34700	18-0937	36170	18-3883	39240	18-4357
33690	18-0106	34710	18-0188	36180	18-3887	39250	18-4319
33700	18-3899	34720	18-2911	36200	18-3825	39260	18-0411
33710	18-2852	34730	18-2918	36220	18-3822	39270	18-4396
33730	18-2557	34740	18-0935	36230	18-3823	39280	18-4394
33740	18-0118	34750	18-0923	36240	18-3824	39290	18-4395
33750	18-2857	34770	18-2916	36250	18-3820	39300	18-4398
33760	18-0418	34771	18-0911	36260	18-3814	39310	18-4399
33765	18-8532	34780	18-0941	36290	18-3855	39320	18-4367
33770	18-2875	34790	18-0424	36300	18-3857	39330	18-4355
33780	18-0401	34800	18-1218	36820	18-0476	39331	18-4340
33790	18-0183-1	34850	18-1224	36830	18-2854	39332	18-4339
33795	18-8509	34860	18-0951	36840	18-0475	39333	18-4336
33800	18-0956	34870	18-0953	37000	18-4313	39335	18-4334
33810	18-0943	34880	18-0957	37010	18-4312	39336	18-4326
33820	18-0673	34890	18-0397	37020	18-4314	39337	18-4325

GLM		GLM		GLM		GLM	
GLM N°.	Sierra N°.	GLM N°.	Sierra N°.	GLM N°.	Sierra N°.	GLM N°.	Sierra N°.
39338	18-4338	40560	18-7042	51330	18-1909	71500	18-5396
39340	18-4315	40570	18-7046	51340	18-1922	71510	18-5395
39350	18-4300	40580	18-7220	51410	18-1902	71520	18-5384
39350	18-4302	40590	18-7221	51420	18-1903	71530	18-5386
39354	18-4310	40600	18-7219	51430	18-1986	71540	18-5385
39355	18-4324	40610	18-7212	51442	18-1901	71550	18-5389
39360	18-4301	40620	18-7213	51480	18-1848	71560	18-5352
39370	18-4305	40630	18-7214	51510	18-1935-1	71570	18-5369
39380	18-4306	40640	18-7215	51520	18-1936	71580	18-5375
39390	18-4321	40650	18-7750-1	51610	18-1930-1	71590	18-5376
39400	18-4322	40651	18-7226	51630	18-1931-1	71600	18-5353
39410	18-4323	40710	18-7093	51640	18-1932	71700	18-5270
39420	18-4307	40720	18-7094	52080	18-1938	71710	18-5269
39430	18-4309	40800	18-7801	52090	18-1984	71720	18-5268
39440	18-4317	40810	18-7823	52230	18-1983	71730	18-5275
39470	18-0466	40820	18-7820	52240	18-1982	71740	18-5277
39490	18-0348	40830	18-7821	53100	18-4362	71750	18-5276
39500	18-0611	40840	18-7822	53300	18-8529	71760	18-5271
39520	18-4359	40850	18-7800	53330	18-8554	71770	18-5267
39550	18-4356	40860	18-7805	53360	18-8556	71780	18-5273
39560	18-4316	40870	18-7806-1	53430	18-8555	71790	18-5274
39590	18-2614	40900	18-7233	53770	18-8539	71800	18-5272
39600	18-2620	40910	18-7061	54110	18-1899	71810	18-5281
39620	18-2619-1	40920	18-7057	54250	18-1996	71820	18-5278
39630	18-2613	40930	18-7041	56030	18-1949	71830	18-5280
39640	18-2615	40950	18-7062	56110	18-1999	72010	18-5179
39650	18-4388	40970	18-7295	56120	18-1907	72020	18-5196
39660	18-4389	41120	18-7477	56140	18-1939	72030	18-5172
39670	18-4390	44990	18-7956	56230	18-1997-1	72040	18-5192
39680	18-4391	45010	18-4217	56240	18-1898	72050	18-5194
39690	18-4392	45020	18-7179	56250	18-1998-1	72060	18-5170
39700	18-4393	45030	18-7180	70010	18-5303	72070	18-5193
39710	18-4375	45050	18-7190	70020	18-5311	72080	18-5176
39720	18-4376	45060	18-7181	70030	18-5310	72100	18-5181
39730	18-4337	45080	18-7183	70040	18-5318	72110	18-5433
39740	18-4378	45090	18-7184	70050	18-5317	72113	18-5443
39750	18-4379	45100	18-7186	70060	18-5314	72114	18-5442
39770	18-4369	45160	18-7194	70070	18-5156	72115	18-5434
39780	18-4370	45170	18-7185	70080	18-5157	72120	18-5178
39790	18-4371	45180	18-7187	70082	18-5305	72130	18-5108
39800	18-4372	45200	18-7137	70100	18-5306	72240	18-5740
39810	18-4373	45230	18-7100	70110	18-5148	72260	18-5711
39820	18-4374	45250	18-0298	70160	18-5153	72310	18-5707
39830	18-4368	45280	18-7405	70170	18-5140	72320	18-5708
39840	18-0405	46100	18-1219	70200	18-5141	72350	18-5709
39850	18-1237	46110	18-1221	70500	18-5349	72360	18-5801
39870	18-4347-1	46120	18-3562	70510	18-5347	72370	18-5815
39880	18-4349	46130	18-1222	70520	18-5344	72380	18-5820
39890	18-4348	46140	18-3567	70530	18-5345	72390	18-5816
39910	18-0604	46150	18-1243	70540	18-5346	72400	18-5817
39920	18-0603	46160	18-3565	70570	18-5199	72402	18-5819
40130	18-7832	46170	18-3564	70580	18-5338	72403	18-5812
40130	18-7838	46180	18-3563	70590	18-5200	72410	18-5802
40140	18-7829	47110	18-3602	70591	18-5348	72420	18-5807
40150	18-7830	47120	18-3601	70640	18-5205	72430	18-5808
40160	18-7831	47130	18-3603	70660	18-5169	72440	18-5814
40280	18-7818-1	50006	18-4008	70670	18-5212	72460	18-5837
40290	18-7817	50310	18-1908K	70680	18-5206	72480	18-5836
40310	18-7804	50330	18-1906	71000	18-5428	72490	18-5838
40320	18-7807	50610	18-1985	71020	18-5418	72500	18-5834
40330	18-7808	51010	18-4009	71030	18-5420	72510	18-5297
40340	18-7809	51030	18-1990	71040	18-5404-1	72520	18-5296-2
40350	18-7811	51110	18-1970-1	71050	18-5407	72530	18-5298
40360	18-7812	51120	18-1971	71050	18-5425	72540	18-5299
40370	18-7813	51130	18-1972	71060	18-5403	72550	18-5295
40380	18-7814	51140	18-1976-1	71070	18-5432	72570	18-5294
40390	18-7810	51160	18-1975-1	71080	18-5431	72590	18-5265
40410	18-7004	51180	18-1937	71090	18-5411	72600	18-5284
40420	18-7005	51190	18-1978	71100	18-5405	72610	18-5250
40435	18-7006-1	51210	18-1956-1	71110	18-5408	72620	18-5251
40460	18-7007	51212	18-1955-1	71120	18-5406	72630	18-5252
40470	18-7013	51220	18-1952-1	71130	18-5403	72640	18-5253
40480	18-7021	51224	18-1960-1	71400	18-5354	72650	18-5260
40490	18-7211-1	51230	18-1953-2	71410	18-5362	72660	18-5258
40500	18-7033	51237	18-1950-1	71420	18-5361	72660	18-5264
40501	18-7037	51238	18-1951-1	71450	18-5393	72670	18-5254
40510	18-7043	51240	18-1957-1	71460	18-5394	72680	18-5256
40530	18-7024	51250	18-1958-1	71470	18-5356	72800	18-5011
40540	18-7026	51252	18-1962-1	71480	18-5358	72810	18-5006
40550	18-7223	51320	18-1921	71490	18-5357	72820	18-5002

*Para localizar el número de página, consulte el índice / referencia de la página 750 a 781

GLM		GLM		GLM		GLM	
GLM N°.	Sierra N°.	GLM N°.	Sierra N°.	GLM N°.	Sierra N°.	GLM N°.	Sierra N°.
72830	18-5003	77260	18-72000	82140	18-7114	85910	18-2094
72840	18-5001	77290	18-7210	82150	18-7117	85960	18-0520
72970	18-5012	79110	18-7605	82170	18-7112	86010	18-2071
72980	18-5008	79120	18-7615	82200	18-7170	86011	18-8300
73010	18-5705	79120	18-7618	82230	18-7155	86012	18-8301
73020	18-5704	79140	18-7616	82240	18-7115	86013	18-8325
73110	18-5116-1	79150	18-7617	82240	18-7464	86030	18-2001
73120	18-5115-1	79180	18-7609	82250	18-7173	86040	18-2020
73180	18-6769-1	79190	18-7608	82260	18-7162	86050	18-2058
73190	18-5107-1	79210	18-7603	82270	18-7196	86060	18-2060
74000	18-5750	80070	18-7421	82280	18-7104	86070	18-2066
74000	18-5950	80080	18-7141	82280	18-7459	86080	18-2072
74000	18-5956	80090	18-7120	82310	18-7152	86090	18-2073
74001	18-5951	80100	18-7101	82320	18-7140	86100	18-3111
74001	18-5957	80100	18-7109	82340	18-7151	86120	18-2025
74100	18-5903	80100	18-7406	82350	18-7121	86130	18-2536
74110	18-5904	80110	18-7413	82360	18-7172	86140	18-2532
74140	18-5905	80120	18-7168	82370	18-7127	86150	18-2027
74140	18-5910	80130	18-7102	82380	18-7169	86160	18-2059
74150	18-5900	80140	18-7165	82390	18-7167	86170	18-2028
74150	18-5911	80160	18-7166	82400	18-7133	86180	18-2029
74170	18-5902	80160	18-7466	82430	18-7407	86190	18-2031
74170	18-5908	80170	18-7410	82440	18-7144	86200	18-2033
74180	18-5901	80180	18-7105	82460	18-7418	86210	18-2537
74180	18-5907	80190	18-7445	82480	18-7107	86230	18-2539
74190	18-5913	80220	18-7129	82900	18-7957	86240	18-2061
75330	18-5754	80330	18-7414	83200	18-7139	86250	18-2062
75340	18-5753	80350	18-7412	83250	18-7138	86270	18-2063
75350	18-5756	80380	18-7177	83340	18-7160	86300	18-2996
75360	18-5757	80390	18-7195	83410	18-7157	86310	18-2516
75370	18-5755	80420	18-7161	83440	18-7159	86350	18-2021
75380	18-5759	80440	18-7415	84026	18-7474	86360	18-2022
75390	18-5760	81030	18-7197	85010	18-2016	86370	18-2000
75400	18-5758	81070	18-7111	85020	18-2049	86380	18-2018
76068	18-7070	81080	18-0175	85030	18-2003	86390	18-2023
76068	18-7746	81080	18-7145	85040	18-2013	86400	18-2024
76081	18-7081	81090	18-7404	85040	18-2026	86410	18-2005
76082	18-7080	81100	18-7116	85050	18-2009	86420	18-2030
76082	18-7089	81100	18-7417	85060	18-2056	86430	18-2032
76083	18-7076	81120	18-7134	85070	18-2014	86440	18-2074
76084	18-7078	81140	18-7174	85080	18-2011	86450	18-2035
76085	18-7097	81140	18-7416	85090	18-0523	86460	18-2064
76086	18-7098	81160	18-7158	85100	18-2019	86470	18-2075
76088	18-7017	81170	18-7440-1	85110	18-2012	86480	18-2704
76096	18-7096	81180	18-7153	85120	18-2051	86481	18-2391
76101	18-7000	81190	18-7103	85130	18-2002	86490	18-2703
76102	18-7001	81210	18-7408	85130	18-2077	86491	18-2705
76103	18-7008	81220	18-7146	85140	18-2944	86492	18-3329
76104	18-7040	81230	18-7156	85150	18-0521	86494	18-3337
76105	18-7085	81230	18-7409	85160	18-0583	86496	18-2392
76107	18-7075	81240	18-7411	85170	18-0522	86497	18-2708
76111	18-7071	81250	18-7143	85200	18-0563	86500	18-2706
76120	18-7086	81260	18-7164	85210	18-2015	86510	18-2034
76123	18-7077	81270	18-7198	85230	18-0514	86520	18-2065
76150	18-7095	81280	18-7403	85260	18-0515	86530	18-2067
76160	18-7072	81290	18-7461	85270	18-0516	86540	18-2769
77010	18-1256	81310	18-7126	85290	18-2017	86570	18-7481
77010	18-7256	81320	18-7457	85330	18-2006	86610	18-2068
77011	18-7286	81340	18-7128	85380	18-0525	86620	18-0166
77040	18-7267	81360	18-7171	85440	18-0517	86630	18-2541
77050	18-7266	81380	18-7130	85460	18-0527	86640	18-7475
77060	18-7265	81390	18-7176	85480	18-2008	86654	18-8352
77070	18-7274	81400	18-7123	85490	18-1211	86660	18-7963
77080	18-7269	81430	18-0858	85520	18-2052	86700	18-2767
77090	18-7275	81430	18-7163	85530	18-2053	86710	18-2768
77101	18-7263	81440	18-7401	85580	18-2055	86711	18-2724
77102	18-7268	81450	18-7108	85581	18-2054	86712	18-2692
77103	18-7270	81470	18-7419	85590	18-2599	86720	18-1240
77105	18-7260	81510	18-7467	85600	18-2007	86740	18-0173
77106	18-7272	81520	18-0860	85610	18-2010	86750	18-0174
77108	18-7271	81540	18-7110	85630	18-0539	86760	18-0542
77113	18-7284	81550	18-7400	85680	18-2048	86760	18-0592
77114	18-7278	81570	18-7449	85700	18-2076	86770	18-0543
77115	18-7289	82030	18-7118	85790	18-0519	86790	18-8307
77116	18-7288	82050	18-7472	85800	18-0526	86810	18-8367
77200	18-4200	82060	18-7959	85810	18-0531	86840	18-0584
77200	18-7200	82080	18-7490	85830	18-0540	87010	18-2990
77220	18-7201	82100	18-7135	85840	18-8353	87020	18-2047
77230	18-7202	82110	18-7420	85850	18-2349	87030	18-2040
77250	18-7208	82130	18-7178	85860	18-1508	87050	18-2043

GLM		GLM		GLM	
GLM N°.	Sierra N°.	GLM N°.	Sierra N°.	GLM N°.	Sierra N°.
87060	18-2041	89120	18-2748	90110	18-9806E
87070	18-2057	89130	18-2746	90140	18-9817
87120	18-2093	89140	18-2756	90160	18-9853
87130	18-8351	89150	18-2760	90170	18-9855
87140	18-8350	89160	18-2733	90180	18-9856
87400	18-2649	89170	18-2732	90190	18-9858
87410	18-2291	89180	18-2747	90200	18-9861
87480	18-2643	89190	18-2764	90210	18-9857
87490	18-2645	89200	18-2765	90220	18-9854
87500	18-2648	89210	18-2763	90230	18-9868
87501	18-2644	89220	18-2745	90240	18-9842
87510	18-2652	89222	18-2780	90260	18-9837
87511	18-2646-1	89224	18-2779	90270	18-9829
87513	18-2642	89230	18-2781	90280	18-9819
87520	18-2653	89240	18-4456		
87530	18-2654	89250	18-4457		
87540	18-2655	89260	18-4458		
87550	18-2590	89450	18-3030		
87561	18-2622	89451	18-3062		
87562	18-3760	89470	18-3005		
87573	18-2627	89480	18-3006		
87574	18-2628	89490	18-3090		
87575	18-2629	89500	18-3091		
87576	18-2697-1	89510	18-3079		
87580	18-8371	89520	18-3080		
87590	18-2626	89530	18-3075		
87600	18-2623	89540	18-3081		
87601	18-2660	89550	18-3077		
87602	18-2656	89560	18-3078		
87603	18-2659	89570	18-3059		
87604	18-2679	89580	18-3001		
87605	18-2682	89590	18-3299		
87606	18-2684	89592	18-3138		
87607	18-2686	89593	18-3295		
87608	18-2689	89594	18-3294		
87609	18-2690	89595	18-3108		
87611	18-2691	89596	18-3326		
87614	18-2694	89600	18-3012		
87616	18-2680	89610	18-3060		
87617	18-2681	89611	18-3061		
87618	18-2683	89612	18-3044		
87619	18-2685	89614	18-8903		
87620	18-2663	89615	18-8901		
87621	18-2687	89620	18-3046		
87622	18-2688	89621	18-3047		
87630	18-2665	89630	18-3056		
87640	18-2664	89640	18-3057		
87650	18-2667	89650	18-3002		
87651	18-2666	89660	18-3083		
87652	18-2669	89670	18-3003		
87653	18-2670	89680	18-3043		
87654	18-2673	89690	18-3055		
87655	18-2671	89710	18-3053		
87656	18-2672	89740	18-3087		
87660	18-2698	89750	18-3051		
87670	18-8360	89760	18-3086		
87680	18-2658	89770	18-3050		
87690	18-2657	89780	18-3368		
87700	18-2625	89790	18-3104		
87800	18-2630	89800	18-3054		
87802	18-2637	89810	18-3039		
87803	18-2632	89820	18-3052		
87804	18-2638	89830	18-3007		
87805	18-2639	89840	18-3017		
87806	18-2633	89850	18-3072		
87807	18-2640	89860	18-3073		
87808	18-2624	89870	18-3066		
87809	18-2635	89880	18-3074		
87810	18-2636	89890	18-3067		
88170	18-7175	89900	18-3068		
89010	18-2757	89910	18-3069		
89020	18-2758	89920	18-3070		
89030	18-2744	89930	18-3071		
89040	18-2752	89940	18-3082		
89050	18-2751	89950	18-3058		
89060	18-2759	89990	18-3366		
89070	18-2762	90050	18-4442		
89080	18-2753-2	90065	18-4446		
89090	18-2761	90070	18-9099		
89100	18-2750	90100	18-9803		

HONDA		HONDA cont.		Mercury Marine cont.		Mercury Marine cont.	
O.E. Nº.	Sierra Nº.						
06192-ZV5-003	18-3282	30520-PWC-003	18-23251	10-805763	18-2361	12-36001	18-4270
06192-ZV7-000	18-3281	30530-P8F-A01	18-7559	10-8083434	18-8404-1	12-38753	18-4275
06192-ZW1-000	18-3283	30530-PPL-A01	18-7558	10-816601	18-3230	12-45176	18-4858-9
06192-ZW1-305	18-3187	31200-HW1-671	18-6877	10-853163	18-2361	12-45810	18-3712
06192-ZY3-000	18-3285	31200-ZV5-013	18-6433	10-86801	18-1706	12-49221	18-2948
06192-ZY6-000	18-3284	31200-ZW1-004	18-15061	10-8M0084649	18-2170	12-492211	18-2948
15400-PFB-007	18-7911-1	31200-ZW9-802	18-6445	10-97934	18-3729	12-77674	18-2316
15400-PFB-014	18-7913	31200-ZY6-003	18-6959	10-97934A1	18-2141	12-77987	18-4220
15400-PLM-A01PE	18-7909	31200-ZY9-003	18-6959	10-98794	18-3231	12-77987A1	18-4220
15400-POH-305	18-7909	31200-ZY9A-0031	18-6959	10-F50109	18-2244	12-815472	18-0318
15400-POH-305PE	18-7909	31630-ZW5-003	18-6475	11-13439-1	18-3721	12-824793	18-4275
15400-ZJI-004	18-7909	31630-ZY6-003	18-6476	11-20361	18-3722	12-835467	18-4220
16010-881-003	18-2482	35655-ZY3-013	18-7657	11-21298	18-3721	12-8354671	18-4220
16010-ST5-993	18-7785	35655-ZY3-C01	18-32153	11-22178	18-3721	12-835467Q01	18-4220
16010-ZV4-005	18-2480	35655-ZY6-013	18-7659	11-22339	18-3713	12-855682-2	18-9078
16010-ZW9-003	18-2481	35655-ZY9-003	18-7658	11-24648	18-3721	12-86645	18-2560
16011-881-741	18-7048	35655-ZY9-013	18-7658	11-29241	18-3721	12-866451	18-2560
16011-ZV4-005	18-7047	35655-ZZ5-004	18-32153	11-33962	18-3721	12-88263	18-1186
16176-POA-004	18-0737	36120-ZV5-821	18-6258	11-34932	18-3720	12-8M0042641	18-4267
16201-881-850	18-2473	36120-ZV5-822	18-6793	11-34933	18-3721	12-8M2001219	18-0681
16221-ZV4-610	18-2470	36120-ZV5-822	18-6837	11-35888	18-3722	12-92647M	18-4233
16221-ZW1-000	18-2472	37500-PNB-003	18-25200	11-35921	18-3719	12-92721	18-2343
16221-ZW9-000	18-2471	37510-PNB-003	18-25201	11-36084	18-3713	12-93416	18-0681
16900-SA5-004	18-7786	37830-PGK-A01	18-7552	11-39823	18-3785	12-934161	18-0681
16900-SR3-004	18-7720	41107-ZV5-00-00	18-6165A	11-39907	18-3785	13-888363-2	18-9077
16901-ZY3-003	18-79909	41107-ZW1-003ZA	18-6011	11-42633	18-2346	14-17460	18-2298
16910-GB2-005	18-7712	41107-ZW1-003ZA	18-6011A	11-45592	18-3723	14-18323	18-2298
16910-GB2-005	18-8225	41107-ZW1-003ZA	18-6241	11-46355	18-3721	14-31210	18-3200
16910-ZV4-015	18-8226	41109-ZW1-003	18-6068	11-47411	18-3719	14-34817	18-3788-9
16911-ZY3-010	18-79908	90508-ZW1-003	18-3200	11-52707	18-3700	14-52833	18-2299
16977-ZV5-900	18-80406	90752-ZV4-650	18-3268	11-52707A1	18-3700	14-76281	18-3204
16977-ZV5-A00	18-80400	90752-ZV5-003	18-3270	11-52707A1	18-3701	14-79447	18-2299
17105-ZY3-004	18-0390	90752-ZV7-000	18-3269	11-52707A2	18-3700	14-816629	18-3200
17105-ZY6-000	18-0300	90752-ZW1-B02	18-3271	11-52707A2	18-3701	14-816629Q	18-3200
17109-XY6-000	18-0382	90752-ZY3-003	18-3273	11-52707Q1	18-3700	14-F697140	18-3200
17109-ZY3-004	18-0396	91051-ZW1-003	18-1156	11-52707Q1	18-3701	15-23097A1	18-2293
17151-ZW5-00	18-0248	91053-ZW1-003	18-1158	11-54034	18-3785	15-31535A1	18-2284
17650-921-003ZB	18-80420	91057-ZW1-003	18-1157	11-69578	18-3704	15-32563A1	18-2282
17650-ZW9-003	18-80408	91251-ZW1-003	18-0583	11-69578A1	18-3702	15-33143A1	18-2295
17660-ZV5-902	18-38008	91252-935-004	18-8298	11-69578Q1	18-3702	15-35931A1	18-2285
17670-ZW1-030GH	18-7947	91252-ZV1-003	18-3288	11-69578T1	18-3702	15-35980A1	18-2292
17670-ZW1-801AH	18-7948	91252-ZW1-003	18-2002	11-805092	18-3783	15-36178A02	18-2293
17700-ZW9-010	18-81042EP-1	91253-ZW1-003	18-2054	11-805092T	18-3783	15-36178A1	18-2293
17700-ZW9-010	18-81042S	91254-ZW1-003	18-0522	11-805093	18-3786	15-39899A1	18-2293
17700-ZW9-020	18-81042EP-1	91254-ZW1-003	18-2053	11-805100T	18-3783	15-42637A1	18-2294
17700-ZW9-020	18-81042S	91255-ZW1-003	18-2053	11-826375	18-3719	15-45691A1	18-2283
17710-ZW9-033	18-80407	91353-ZW1-003	18-7198	11-8267089	18-3722	15-45811	18-2296
19021-ZW1-003	18-3214	91356-ZY3-003	18-8299	11-82671015	18-3721	15-47397A1	18-2285
19210-881-A01	18-3245	JOHNSON/EVINRUDE		11-82671127	18-3785	15-57007A1	18-2295
19210-881-A02	18-3245	586768	18-6826	11-827614	18-3700	15-71013	18-2296
19210-ZV4-013	18-3246	5005034	18-3753	11-859116	18-3721	15-8M0063267	18-2294
19210-ZV4-651	18-3246	5005831	18-6815	11-859131	18-3783	17-14872	18-2393
19210-ZV4-651	18-3247	5036972	18-6945	11-862907	18-3786	17-14872A1	18-2463
19210-ZV5-003	18-3248	MERCURY MARINE		11-863332	18-3728	17-14873	18-2394
19210-ZV7-003	18-3249	10-14834	18-2375	11-88228	18-3703	17-14873A1	18-2462
19210-ZW1-003	18-3056	10-14834A1	18-2375	11-88462	18-2460	17-30632	18-2357
19210-ZW1-B04	18-3250	10-14834A1	18-23751-9	11-95702	18-3721	17-35973	18-3227
19210-ZW9-003	18-3100	10-20259	18-2244	11-97522	18-3713	17-44166	18-2396
19210-ZW9-013	18-3100	10-20518	18-2303	11-99298	18-3728	17-44166T1	18-2461
19210-ZW9-A02	18-3245	10-28634	18-2244	11-F694188	18-3719	17-44167	18-2397
19210-ZW9-A31	18-32455	10-28634A1	18-2244	12-12577	18-1191	17-44167A1	18-2397
19210-ZW9-A32	18-32455	10-28668	18-3229	12-13171	18-4220	17-45735	18-2152
19210-ZY3-003	18-3031	10-30206	18-2361	12-19183	18-2945	17-45738	18-2151
19231-ZW1-003	18-3122	10-30720	18-3226	12-191832	18-2945	17-815953	18-2395
19232-881-850	18-2608	10-31700	18-2163	12-191833	18-2945	17-815953A1	18-2395
19232-ZV1-A10	18-2524	10-31700	18-2163E-9	12-20260	18-2945	17-815953T1	18-2464
19232-ZV4-610	18-2495	10-32470	18-6245	12-22388	18-4275	17-828507 1	18-15129
19232-ZW1-003	18-2563	10-36289	18-3729	12-23245	18-2948	17-85056	18-2462
19233-ZV5-000	18-2496	10-43749	18-8410	12-25410	18-0203	17-8M0030941	18-2357
19234-881-850	18-2609	10-44387	18-8411	12-25945	18-4275	17-8M0035070	18-2464
19234-ZW1-003	18-2564	10-45590	18-2170	12-29245	18-4275	17-8M0084681	18-2357
19234-ZY3-000	18-2499	10-67373	18-3197	12-29395	18-4267	17-99207	18-2463
19242-ZV5-000	18-0176	10-76156	18-3197	12-31211	18-3714	18-52457	18-2848
19242-ZW1-003	18-2565	10-79953	18-2244	12-31211A2	18-3714	18-524571	18-2848
19300-881-741	18-3629	10-79953A2	18-2244	12-31211A3	18-3714	19-14842	18-2465-9
19300-881-761	18-3627	10-79953Q04	18-2244	12-31211Q03	18-3714	19-148421	18-2465-9
19300-ZV5-043	18-3630	10-79953Q2	18-2244	12-31266	18-2340	19-32652	18-4272
19300-ZW9-003	18-3628	10-8053432	18-8402	12-32733	18-4275	19-42682	18-4273
30520-PNA-007	18-7494	10-8053433	18-8403	12-32834	18-0681	19-47579	18-3232
				12-34961	18-9805	19-475791	18-3232
				12-35935	18-0203	19-815951	18-2466-9

*Para localizar el número de página, consulte el índice / referencia de la página 750 a 781

Mercury Marine cont.		Mercury Marine cont.		Mercury Marine cont.		Mercury Marine cont.	
21-42990A10	18-7817	23-32632	18-3236	23-90203	18-2336	25-809086	18-0715
21-42990A7	18-7817	23-34464	18-1317	23-99291	18-2702-04	25-818573	18-7400
21-42990A8	18-7817	23-37428A1	18-2155	23-99291	18-2702-1	25-82275M	18-0298
21-42990A9	18-7817	23-43045	18-0568-9	23-99291T	18-2702-04	25-82289M	18-0299
21-806118	18-33800	23-43293	18-1339	23-99291T	18-2702-1	25-823683	18-7414
21-857005A1	18-7817	23-43293T	18-1339	24-17057A1	18-1234	25-85491A87	18-4325
22-13563A3	18-8076	23-44165	18-4288	24-17997A1	18-2715	25-85549	18-7956
22-13563A6	18-8091	23-45736	18-2701	24-29340A1	18-6506	25-85594	18-7100
22-13563A7	18-8091	23-45736	18-2701-04	24-29340T1	18-6506	25-861844	18-7961
22-13563Q3	18-8076	23-47392	18-2336	24-30893	18-2348	25-87400A2	18-2649
22-13563Q7	18-8091	23-48351	18-1329	24-38191	18-4161	25-897536	18-7113-9
22-13563T3	18-80410	23-49163	18-1315	24-46312	18-4252	25-8M0027717	18-7195
22-13563T7	18-8091	23-49168	18-1334	24-801879	18-1234	25-90011	18-7176
22-14213M	18-8075	23-49171	18-1333	24-801879T	18-1234	25-94288	18-7474
22-14213Q	18-8075	23-52211	18-1300	24-811554	18-1234	25-97386	18-7167
22-16610M	18-8084	23-52221	18-1308	25-20081	18-7151	25-97387	18-7449
22-16951A1	18-4218	23-52224	18-1309	25-201951	18-7134	25-98277	18-7113-9
22-16951Q1	18-4218	23-52225	18-1341	25-20415	18-7421	26-12224	18-2076
22-16951T1	18-4218	23-52242	18-1329	25-20826	18-7459	26-14077	18-2077
22-30139	18-4263	23-52261	18-1317	25-20863	18-7152	26-14240	18-0519
22-32802	18-4263	23-52264	18-1316	25-21836	18-7153	26-16709A1	18-2643
22-328021	18-4263	23-52270	18-1308	25-23145	18-7114	26-16709A2	18-2643
22-328022	18-4263	23-52273	18-1309	25-25439	18-7420	26-16977	18-2013
22-32803	18-4264	23-52274	18-1341	25-26543	18-0175	26-16977	18-2026
22-33198	18-4258	23-52928	18-3109	25-26722	18-7115	26-20070	18-2004
22-33198A1	18-4258	23-55419A1	18-2155	25-26802	18-7180	26-23517	18-2015
22-36305	18-8216	23-61290	18-2701	25-26855	18-7155	26-24590	18-2048
22-36305T	18-8216	23-61290	18-2701-04	25-29439	18-7156	26-25329	18-0514
22-36392	18-8111	23-61291	18-2336	25-29845	18-7103	26-27163	18-2019
22-41622	18-4258	23-67370	18-2349	25-29976	18-7157	26-29677	18-3110
22-41622	18-4258	23-67484	18-1340	25-30224	18-7173	26-30530	18-0515
22-424254	18-8958	23-69884	18-1334	25-30271	18-7426	26-30696	18-8308
22-42861	18-4265	23-69887	18-1333	25-30529	18-7171	26-30900	18-8310
22-428611	18-4265	23-77631A2	18-2155	25-30613	18-7158	26-30913	18-0516
22-46754	18-4258	23-79373A1	18-2622	25-31305	18-7172	26-32121	18-2017
22-63186	18-8054	23-801793	18-1311	25-31534	18-7159	26-32511	18-2049
22-63187	18-8055	23-801801	18-1321	25-31986	18-7160	26-32511A1	18-2648
22-64426	18-4218	23-801803	18-1320	25-32509	18-7165	26-32911	18-0517
22-67892	18-2375	23-801849	18-1303	25-32546	18-7161	26-33144A1	18-2652
22-67892A05	18-2375	23-805041A2	18-2622	25-33145	18-7162	26-33144A2	18-2652
22-67892A06	18-2375	23-806036A1	18-3760	25-33465	18-7163	26-34217	18-0518
22-67892A1	18-2375	23-807073	18-4288	25-33466	18-7164	26-36143	18-2094
22-67892A1	18-23751-9	23-811858	18-1337	25-33504	18-7170	26-36556	18-0563
22-806608A02	18-4226	23-811858001	18-1337	25-35027	18-7117	26-36557	18-0521
22-806608A1	18-4226	23-815921A10	18-2353	25-35029	18-7121	26-36557A1	18-3110
22-806926	18-4227	23-815921A17	18-2353	25-35276	18-7135	26-38970	18-3110
22-806926A1	18-4224	23-815921A21	18-2353	25-35480	18-7411	26-41131	18-0579
22-807155	18-4461	23-815921A6	18-2353	25-36318	18-7440-1	26-41132	18-0580
22-81042M	18-8075	23-815921A8	18-2353	25-36390	18-7410	26-41365	18-0581
22-816856T2	18-80412	23-815950	18-2341-1	25-38933	18-7120	26-41365A3	18-2697-1
22-818994	18-8957	23-8159501	18-2341-1	25-39695	18-7464	26-41953	18-2016
22-8189941	18-8957	23-815950Q01	18-2341-1	25-45253	18-7165	26-42102	18-2728
22-841908	18-4265	23-816583	18-3222	25-45254	18-7166	26-421021	18-2728
22-861187	18-4265	23-818465	18-1300	25-45710	18-7198	26-43034A1	18-2626
22-862210	18-4227	23-818469	18-1317	25-45711	18-7174	26-43034A2	18-2626
22-862210A01	18-4224	23-818469001	18-1317	25-47254	18-7961	26-43034A3	18-2626
22-87238	18-4218	23-818471	18-1316	25-47632	18-7146	26-43035	18-0583
22-87543	18-4264	23-818471001	18-1316	25-48171	18-7168	26-43035A4	18-2626
22-88847A1	18-2460	23-818473	18-1315	25-53421	18-7177	26-43036	18-0522
22-8M0001721	18-8956	23-818473001	18-1315	25-54029	18-0858	26-43993	18-0523
23-11992	18-1327	23-818477	18-1314	25-54030	18-7467	26-45577	18-2944
23-11992001	18-1327	23-853853	18-1148	25-55801	18-7445	26-455771	18-2944
23-15960	18-1300	23-853853002	18-1148	25-60342A1	18-2291	26-45587	18-0525
23-15961	18-1308	23-853853A1	18-1148	25-60342A2	18-2291	26-48443	18-0526
23-1596110	18-1309	23-85669	18-1317	25-62700	18-0860	26-49131	18-4022
23-1596120	18-1341	23-85677	18-1329	25-62702	18-7413	26-49154	18-1233
23-1761515	18-0208	23-85684	18-1305	25-62704	18-7116	26-49947	18-1211
23-1761516	18-0210	23-85686	18-1315	25-62705	18-7105	26-55682	18-2050
23-1761517	18-0212	23-85691	18-1333	25-62706	18-7102	26-55682A1	18-2653
23-1761518	18-0214	23-85698	18-1300	25-62817	18-7175	26-56397	18-0527
23-1761519	18-0216	23-85701	18-1308	25-64067	18-7414	26-56788	18-2008
23-1761520	18-0218	23-85704	18-1309	25-64068	18-7145	26-56866	18-1230
23-1761521	18-0220	23-85705	18-1341	25-64966	18-7415	26-56868	18-0528
23-1761522	18-0222	23-85715	18-1317	25-65936	18-7143	26-58094	18-0518
23-1761523	18-0224	23-85718	18-1316	25661T1	18-5836	26-58094	18-4023
23-1761524	18-0226	23-85726	18-1334	25-67202	18-7107	26-58203	18-1211
23-1761526	18-0230	23-85726001	18-1334	25-69202	18-7419	26-62818	18-0529
23-29804	18-3109	23-888690	18-9075	25-70937	18-7169	26-66022	18-0584
23-29804T	18-3109	23-888690-1	18-9076	25-803513007	18-76695	26-66303	18-0595
23-30617A1	18-2154	23-89574	18-2701	25-805726	18-7188	26-66303A1	18-2627
23-30617A2	18-2154	23-89574	18-2701-04	25-8071341	18-1508	26-67388	18-0578

Mercury Marine cont.		Mercury Marine cont.		Mercury Marine cont.		Mercury Marine cont.	
26-67863	18-4022	27-13461A88	18-4340	27-32816	18-2896-1	27-414992	18-2714
26-69188	18-2051	27-13461A89	18-4340	27-32910	18-0356	27-414993	18-2714
26-69189	18-2052	27-13461A90	18-4340	27-33121	18-2830-1	27-414994	18-2714
26-70081	18-2053	27-13461A99	18-4340	27-33179	18-2917	27-414995	18-2714
26-72564	18-0518	27-13687	18-3877	27-331791	18-2552	27-41499A87	18-4334
26-72564	18-4023	27-13709	18-3878	27-331792	18-2552	27-41610	18-0467
26-72785	18-0531	27-13709T	18-3878	27-33395	18-0872	27-41636A1	18-4381
26-75413	18-0518	27-13865	18-1237	27-33395	18-2949	27-41670-3	18-0336
26-75413	18-4023	27-138651	18-1237	27-33395A1	18-4394	27-41670-5	18-0336
26-75624	18-0518	27-13937-6	18-0320	27-33395A2	18-4394	27-41811	18-0672
26-75624	18-4023	27-139581	18-2621	27-33918	18-0398	27-41812	18-2554
26-75982	18-4022	27-14241	18-0322	27-33956	18-0327	27-41812Q	18-2554
26-75988	18-4022	27-14247	18-0405	27-34041	18-0347	27-41813	18-0897
26-76384	18-8347	27-142471	18-61513	27-34042	18-0346	27-41899M	18-2785
26-76868	18-2002	27-14247-1	18-0405	27-34043	18-2845	27-42178	18-0633
26-76868A04	18-2645	27-14247T1	18-61513	27-34207	18-0340	27-42206	18-2559
26-76868A1	18-2645	27-14250	18-0976	27-34208	18-0328	27-42457A1	18-4377
26-76868A2	18-2645	27-14318 3	18-0323	27-34209	18-0329	27-42631	18-2919
26-77066A1	18-2628	27-14318-2	18-0323	27-34213	18-0889	27-426311	18-2919
26-79831	18-2055	27-146972	18-0644	27-34213A1	18-4375	27-42744	18-3879
26-79831A1	18-2654	27-14697A87	18-4339	27-34213A2	18-4375	27-43004009	18-2741
26-80239M	18-2730-9	27-14765	18-25001	27-34216	18-0887	27-430041	18-2741
26-814622	18-1211	27-14901	18-0466	27-34273	18-3880	27-430042	18-2741
26-814669A2	18-2635	27-14901A1	18-0466	27-342731	18-3880	27-430043	18-2741
26-814754	18-8305	27-15172	18-0324	27-34274	18-3881	27-430045	18-2741
26-81607M	18-2731	27-15172-3	18-0324	27-34278	18-3876	27-430047	18-2741
26-816464	18-8347	27-151724	18-0324	27-34486	18-0874	27-43004A86	18-4336
26-8164641	18-2054	27-167371	18-0645	27-344861	18-0874	27-43004A90	18-4336
26-8164641	18-8347	27-17145	18-0868	27-344863	18-0874	27-43004A99	18-4336
26-816575A1	18-2646-1	27-17467	18-0664	27-34502	18-0905	27-430051	18-2740
26-816575A2	18-2599	27-18272	18-0881	27-34614	18-2570	27-430052	18-2740
26-816575A3	18-2646-1	27-18272	18-0881-1	27-34891	18-0874	27-430053	18-2740
26-816575A4	18-8382	27-18307-1	18-0643	27-34895	18-0976	27-430055	18-2740
26-816575A5	18-2642	27-183076	18-0643	27-34896	18-0891	27-430056	18-2740
26-821309	18-3013	27-187851	18-3861	27-34897	18-0891	27-430057	18-2740
26-821310	18-3014	27-187853	18-3861	27-34898	18-0876	27-43006-2	18-0339
26-821928	18-0585	27-18785T	18-3861	27-35380	18-0893	27-430066	18-0339
26-821947	18-1233	27-187861	18-3861	27-35898A2	18-4395	27-43007	18-0670
26-8219471	18-1233	27-18786-1	18-3871	27-35898A3	18-4395	27-430073	18-0670
26-82234M	18-0297	27-187863	18-3861	27-35898A4	18-4395	27-430075	18-0670
26-82257M	18-0267	27-18786T	18-3861	27-35982	18-2840	27-43008	18-0341
26-823894	18-2003	27-188891	18-0624	27-35996	18-2556	27-430082	18-0341
26-830749	18-2430	27-18937	18-3828	27-35996	18-2617	27-430083	18-0341
26-830749	18-24301-9	27-18937M	18-3828	27-35996A1	18-2556	27-430085	18-0341
26-830749A01	18-2725	27-19050	18-0642	27-35996A1	18-2617	27-430086	18-0341
26-84813M	18-0554	27-190502	18-0642	27-37724	18-0879	27-43033	18-2564
26-85090A1	18-2629	27-190503	18-0642	27-37725	18-0103	27-430331	18-2564
26-85090A2	18-2624	27-190505	18-0642	27-37816	18-2507	27-43034	18-2563
26-85107	18-0537	27-190506	18-2735	27-37976	18-0988	27-430341	18-2563
26-854017M	18-0296	27-19138	18-3804	27-38501	18-0879	27-43047	18-2565
26-864319	18-3289	27-19138M	18-3804	27-385011	18-0879	27-430471	18-2565
26-88397A1	18-2644	27-19202	18-2559	27-39164	18-3881	27-430472	18-2565
26-88416	18-2094	27-19204-2	18-2558	27-39316	18-0371	27-43186A1	18-4381
26-888483	18-0564	27-19206	18-0633	27-39401	18-0333	27-43337	18-2713
26-892361	18-2009	27-192061	18-0633	27-39402	18-0334	27-433371	18-2713
26-89238	18-2014	27-19315	18-3877	27-39623	18-2827	27-433372	18-2713
26-89238A1	18-2652	27-194541	18-2593	27-39625	18-2828	27-433373	18-2713
26-89238A2	18-2655	27-19551	18-2824	27-39915	18-2819	27-433374	18-2713
26-896600	18-0560	27-19552	18-2841	27-39915	18-2819-1	27-43337A1	18-2713
26-897153	18-2010	27-19553	18-2823	27-39923	18-1210	27-43777	18-2810
26-897154	18-2006	27-19701	18-0622	27-41245-1	18-3872	27-437771	18-2810
26-8M0050563	18-4024	27-22023	18-2572	27-41246-1	18-3862	27-437772	18-2810
26-90562	18-2011	27-25848	18-2568	27-41382	18-2837	27-43779	18-2809
26-90925	18-0864	27-25849	18-2569	27-41417	18-2710	27-437791	18-2809
26-94038	18-2007	27-25851	18-2570	27-414171	18-2710	27-437792	18-2809
26-965031	18-2056	27-26891	18-2800	27-414172	18-2710	27-43779A87	18-4326
26-97530	18-0172	27-27936	18-0870	27-41418	18-2712	27-443281	18-2943
26-97664	18-4024	27-279361	18-0870	27-414181	18-2712	27-443282	18-2943
26-976641	18-4024	27-30603	18-2914	27-41449	18-0633	27-443283	18-2943
26-99325	18-0586	27-30604	18-2915	27-414491	18-0633	27-443284	18-2943
27-11338	18-2513	27-30803	18-0385	27-41475	18-2717	27-45088	18-0373
27-11338A85	18-4319	27-31402	18-2571	27-414751	18-2717	27-45588	18-2622
27-11338A88	18-4319	27-31436	18-2837	27-414752	18-2717	27-45748	18-0385
27-11977	18-4408	27-31439	18-2836	27-414753	18-2717	27-45821	18-2614
27-11977A88	18-4388	27-31557	18-0385	27-414754	18-2717	27-45821	18-2820
27-11977A92	18-4388	27-32433	18-2914	27-414755	18-2717	27-46110	18-0942
27-11986	18-3879	27-32434	18-2915	27-414756	18-2717	27-46110A1	18-4353
27-11987	18-4408	27-32438	18-2801	27-414757	18-2717	27-46110A2	18-4353
27-11988	18-0311	27-32769	18-2823	27-414758	18-2717	27-46110A72	18-4353
27-11999	18-2845	27-32770	18-2824	27-41499	18-2716	27-46233	18-2836
27-13218	18-3877	27-32771	18-2825	27-414991	18-2716	27-46401	18-2830

*Para localizar el número de página, consulte el índice / referencia de la página 750 a 781

Mercury Marine cont.		Mercury Marine cont.		Mercury Marine cont.		Mercury Marine cont.	
27-46401	18-2830-1	27-55306A74	18-4355	27-68714A7	18-4380	27-757911	18-2800
27-46401A1	18-4396	27-55306A75	18-4355	27-68715	18-0956	27-75909	18-0369
27-46820	18-0418	27-55308	18-0940	27-68715	18-0956-1	27-75952	18-0151
27-46820A1	18-4397	27-55810	18-0894	27-69238	18-2835	27-76401	18-2504
27-47453	18-3881	27-558101	18-0894	27-692381	18-2835	27-76589	18-0139
27-47453A1	18-4389	27-56110	18-3883	27-69524	18-0918	27-76589A77	18-4357
27-47510	18-2553	27-56173	18-0352	27-695241	18-0918	27-76589A78	18-4357
27-47510Q	18-2553	27-56304	18-0982-1	27-695242	18-0918	27-76589A79	18-4357
27-47590	18-2831	27-56859	18-0898	27-69525	18-0131	27-76636	18-0151
27-475901	18-2831	27-56870A1	18-0407	27-695251	18-0131	27-76862	18-0932
27-47644	18-0342	27-56880	18-0147	27-695252	18-0131	27-768621	18-0932
27-47644	18-0342	27-56883	18-0889	27-69659	18-2800	27-76952	18-0101
27-476441	18-0342	27-56884	18-0357	27-70142	18-0360	27-77417	18-2841
27-48042	18-0885	27-58764	18-0353	27-70143	18-0994	27-78026	18-2507
27-48042	18-0885-1	27-60208	18-2834	27-701431	18-0994	27-78027	18-0940
27-48043	18-2832-1	27-60286	18-2512	27-70143B1	18-0994	27-78028A78	18-4355
27-48043	18-2832-1-9	27-60310	18-2504	27-70335	18-0922	27-78035	18-2836
27-48043	18-2832-9	27-60317	18-0904	27-703351	18-0922	27-78068	18-2503
27-480431	18-2832	27-60475	18-2573	27-70905	18-0158	27-78069	18-0934-1
27-480431	18-2832-1	27-60476	18-2574	27-72098	18-4380	27-78087	18-2837
27-480431	18-2832-1-9	27-60476A72	18-4356	27-72142	18-2573	27-78246	18-0135
27-480431	18-2832-9	27-60476A73	18-4356	27-721421	18-2573	27-782461	18-0135
27-48164	18-2802	27-60476A74	18-4356	27-72479	18-4366	27-78409	18-0371
27-481641	18-2802	27-60476A75	18-4356	27-72479A5	18-4366	27-78410	18-0372
27-48330	18-3876	27-60477	18-2839	27-72479T	18-4366	27-78411	18-0373
27-48399	18-0462	27-60479	18-2835	27-72486	18-0942	27-78623	18-0139
27-48713	18-0982-1	27-60715	18-0354	27-72486A32	18-4353	27-78690	18-0936
27-48818	18-2844	27-60721	18-0905	27-72486A76	18-4353	27-79373	18-2622
27-488181	18-2844	27-60945	18-0912	27-72486A78	18-4353	27-79650	18-0103
27-48818Q1	18-2844	27-61224	18-3877	27-72486A79	18-4353	27-796501	18-0103
27-49104	18-3877	27-61782	18-0403	27-72487	18-2507	27-79986	18-3878
27-49107	18-0348	27-62386	18-0182	27-72496	18-0103	27-801328158	22423
27-49109	18-0980	27-62860	18-0988	27-72505	18-2500	27-801761363	22423
27-49110	18-0903	27-628601	18-0988	27-72506	18-2807	27-801853	18-4387
27-49121	18-0464	27-63309	18-2572	27-72507	18-2574	27-801855	18-4365
27-49814	18-0467	27-64173	18-2835	27-72508	18-0944	27-803508	18-3844
27-49936	18-0346	27-64203	18-0107	27-72509	18-2839	27-803508017	18-60917
27-49949	18-0340	27-64203A73	18-4351	27-72510	18-0107	27-804908A00	18-74805
27-49953	18-0887	27-64203A74	18-4351	27-72622	18-3881	27-805215	18-0916
27-49955	18-0905	27-64203A75	18-4351	27-72627	18-0153	27-8052151	18-0916
27-52076	18-2833	27-64204	18-0944	27-72637	18-0868	27-805396	18-0740
27-52144	18-0466	27-64692	18-0356	27-72779	18-0916	27-805403A1	18-0404
27-52145	18-0347	27-64763	18-3883	27-72780	18-0386	27-805722A1	18-0403
27-52184	18-0874	27-64763A2	18-4391	27-72915	18-0371	27-806452	18-0347
27-52202	18-2845	27-64798	18-0407	27-72916	18-0372	27-807218	18-0928
27-52364	18-2946	27-64818	18-2820	27-72917	18-0373	27-807218	18-0928-1
27-52364	18-3880	27-64818A1	18-2614	27-72918	18-2837	27-807473A1	18-0488
27-524572	18-2848	27-64818A1	18-2820	27-72919	18-2836	27-807982	18-0994
27-52546	18-2896	27-64818A2	18-2619-1	27-73377	18-2804	27-8079821	18-0994
27-52546	18-2896-1	27-64818A2	18-2743	27-733771	18-2804	27-807982B	18-0994
27-52550	18-0348	27-64818A20	18-2614	27-73397	18-0101	27-81031M	18-0232
27-52571	18-0403	27-64818A20	18-2820	27-73440A76	18-4357	27-81084	18-2946
27-52579	18-0372	27-64818A3	18-2619-1	27-73645	18-0926	27-810841	18-3880
27-52584	18-2830-1	27-64818A3	18-2619-1	27-73645A32	18-4354	27-810846	18-1239
27-52892	18-0133	27-64818A4	18-2614	27-73645A76	18-4354	27-810846T	18-1239
27-52893	18-2500	27-64818A4	18-2820	27-73645A87	18-4354	27-811546	18-3874
27-53045	18-2917	27-64818Q4	18-2614	27-73665	18-0133	27-811547	18-3887
27-530451	18-2917	27-64818Q4	18-2820	27-73666	18-0685	27-811566	18-1232
27-53354	18-2912	27-64818T1	18-2614	27-73814	18-0928	27-811572	18-0468
27-53354	18-2912-1	27-64857	18-0131	27-73814	18-0928-1	27-811588	18-25002
27-53354A1	18-4398	27-64940	18-2807	27-738141	18-0928	27-812712	18-0403
27-53650	18-2514	27-65184	18-0465	27-738141	18-0928-1	27-812755	18-2610
27-53862	18-2515	27-65577	18-0357	27-73866	18-0183	27-8127551	18-2611
27-53863	18-2807	27-65744	18-0129	27-73866	18-0183-1	27-812755A01	18-2611
27-54014	18-2620	27-657441	18-0129	27-74264	18-3878	27-8127754	18-2610
27-54014	18-2847	27-657442	18-0129	27-74264A1	18-4382	27-8127755	18-2611
27-54014A1	18-2620	27-657443	18-0129	27-74511	18-2504	27-812867	18-2749
27-54014A1	18-2847	27-65788	18-2806	27-74830	18-2843	27-8128671	18-2749
27-54014Q1	18-2620	27-66101	18-2835	27-74830A1	18-4382	27-8128672	18-2729
27-54014Q1	18-2847	27-66102	18-0912	27-74830A3	18-4382	27-812867A91	18-4337
27-54014T1	18-2620	27-661021	18-0912	27-75450	18-0365	27-812867A96	18-4337
27-54014T1	18-2847	27-66358	18-2837	27-75483	18-0611	27-812867A97	18-4337
27-54529	18-0980	27-66847	18-0914	27-75611	18-3876	27-813859	18-0646
27-54529A1	18-4378	27-67208	18-2513	27-75611001	18-3876	27-81417M	18-0292
27-54566	18-0183	27-67275	18-0359	27-75611A03	18-1254	27-814210	18-0463
27-54566	18-0183-1	27-672751	18-0359	27-75611A1	18-4392	27-81421M	18-0294
27-54566A1	18-4399	27-67389	18-0864	27-75611A2	18-4392	27-814703	18-2815
27-55279	18-2838	27-67738	18-2501	27-75646	18-3883	27-814754A00	18-4338
27-552791	18-2838	27-67751	18-2509	27-75647	18-3883	27-815528	18-0680
27-55306A72	18-4355	27-68714	18-4380	27-75648	18-0410	27-815791A00	18-64217
27-55306A73	18-4355	27-68714A6	18-4380	27-75791	18-2800	27-815791A92	18-4359

Mercury Marine cont.		Mercury Marine cont.		Mercury Marine cont.		Mercury Marine cont.	
27-815792A90	18-4359	27-85653A32	18-4356	27-92332	18-2716	30-20464	18-1153
27-815809A90	18-4359	27-85653A79	18-4356	27-92648M	18-2787	30-20839	18-1190
27-815810A90	18-4359	27-85653A87	18-4356	27-92720	18-0954	30-20839T	18-1190
27-816460	18-3879	27-856704	18-2826	27-93214	18-0324	30-20861	18-1398
27-817277	18-2566	27-856705	18-0113	27-93536	18-2501	30-23679	18-1152
27-8172771	18-2566	27-856705	18-0113-1	27-935361	18-2501	30-35914	18-1155
27-817533	18-0384	27-856730	18-0946	27-94914	18-0386	30-36056	18-2101
27-818188	18-1231	27-85817A1	18-0153	27-94915	18-0916	30-36418	18-2101
27-8181881	18-1231	27-858524	18-2915	27-94996	18-2619-1	30-41421	18-1345
27-818832	18-2849-1	27-858524	18-2915	27-94996	18-2743	30-43011	18-1346
27-81987	18-4698	27-858935	18-0649	27-949962	18-2743	30-43011T	18-1346
27-81987M	18-4698	27-85978	18-2710	27-94996A1	18-2619-1	30-49313	18-1153
27-81987M	18-46981-9	27-85979	18-2712	27-94996A1	18-2743	30-54215	18-1153
27-822189	18-0345	27-860231	18-0672	27-94996A2	18-2619-1	30-562540A3	18-21005
27-822844-1	18-3864	27-860232	18-2849-1	27-94996A2	18-2743	30-60794A2	18-2100
27-823142	18-0378	27-860233	18-0897	27-94996A20	18-2619-1	30-60794A2	18-21001
27-823142 2	18-0378	27-863724	18-0897	27-94996A20	18-2743	30-60794A2	18-2100K
27-824326	18-1238	27-863725	18-0672	27-94996A3	18-2743	30-60794A4	18-2100
27-824326002	18-0487	27-8637251	18-0672	27-94996Q2	18-2619-1	30-60794A4	18-21001
27-8243261	18-0487	27-863726	18-2849-1	27-94996Q2	18-2743	30-60794A4	18-2100K
27-824853	18-0835	27-863891	18-2736	27-94996T2	18-2619-1	30-62699	18-1190
27-8248531	18-0835	27-863893	18-2736	27-96171	18-2505	30-63326	18-1153
27-825032	18-3845	27-863895	18-2736	27-961711	18-2505	30-63326T	18-1153
27-825482	18-3827	27-864547A02	18-0721	27-96278	18-2808	30-63742	18-1154
27-8254821	18-3827	27-864547A1	18-0721	27-96286	18-2713	30-63742T	18-1154
27-827154	18-61319	27-864547A1	18-0722	27-96429	18-1204	30-67923	18-1345
27-827284	18-2721	27-864549A02	18-0720	27-96429	18-1204-1	30-67923T	18-1345
27-828292	18-0641	27-864549A1	18-0720	27-96429	18-1204-1-9	30-72961	18-1398
27-828553	18-0319	27-864850A02	18-0722	27-96429	18-1204-9	30-803097T1	18-2601-1
27-832933006	18-2739	27-87105	18-2849-1	27-96440	18-2508-1	30-803097T1	18-8213
27-8329331	18-2739	27-871051	18-2849-1	27-96483	18-2810	30-803098T1	18-8205
27-8329332	18-2739	27-87396	18-2502	27-96485	18-2809	30-803098T1	18-8217
27-8329333	18-2739	27-87707	18-0948	27-96542-1	18-3863	30-803099T1	18-8206-1
27-8329334	18-2739	27-879150139	18-3874	27-96761	18-2510	30-803099T1	18-8218
27-8329335	18-2739	27-879150140	18-3879	27-967611	18-2510	30-803100T1	18-8212-1
27-834952001	18-60919	27-879150141	18-3887	27-97529	18-3877	30-803100T1	18-8219
27-835383001	18-60915	27-88046	18-0950	27-97542	18-0113	30-862540A04	18-21005
27-835427003	18-60918	27-880729	18-0791	27-97542	18-0113-1	30-862540A04	18-21005K
27-835427A04	18-64221	27-881715	18-0322	27-97863	18-0881	30-862540A04	18-21006
27-83899M	18-3828	27-883964	18-0405	27-97863	18-0881-1	30-862540A3	18-21005K
27-83940M	18-0380	27-883964T	18-0405	27-98185	18-2807	30-862540A3	18-21006
27-84733M	18-3804	27-88449	18-2504	27-981851	18-2807	30-862540T1	18-21005
27-850283	18-2737	27-88449A32	18-4357	27-9818512	18-2807	30-862540T1	18-21005K
27-850318	18-3675	27-88449A80	18-4357	27-981853	18-2807	30-862540T1	18-21006
27-8503181	18-3675	27-88451	18-0139	27-98769	18-0970	30-879194A01	18-21005
27-850470	18-3887	27-884511	18-0139	27-987691	18-0970	30-879194A01	18-21005K
27-850836001	18-60916	27-88907	18-0952	27-98823	18-0388	30-879194A01	18-21006
27-85087	18-2561	27-892157	18-2714	27-988231	18-0388	30-879194A02	18-2100
27-853702005	18-60920	27-892158	18-2717	27-98990M	18-3828	30-879194A02	18-21001
27-85487	18-2507	27-89221	18-0384	27-99049M	18-74501	30-879194A02	18-2100K
27-85488	18-0940	27-892211	18-0384	27-99173-2	18-2511	30-88957A1	18-1155
27-854881	18-0940	27-89221A32	18-4319	27-99176	18-2506-1	30-88957T	18-1155
27-854882	18-0940	27-89221A84	18-4319	27-991762	18-2506-1	30-89957	18-1155
27-85489-2	18-0105	27-89221A85	18-4319	27-991763	18-2506-1	31-12576	18-1112
27-85490-2	18-2805	27-89221A88	18-4319	27-991764	18-2506-1	31-12578	18-1113
27-85491	18-0942	27-89656	18-2555	27-99177	18-2503	31-12578T	18-1113
27-854911	18-0942	27-896561	18-2555	27-991771	18-2503	31-14358001	18-2746
27-85491-2	18-0942	27-89656A1	18-4381	27-991772	18-2503	31-17514	18-1194
27-854913	18-0942	27-89657	18-0111	27-99326	18-2562	31-17514A1	18-1194
27-85491A90	18-4325	27-89937	18-0385	27-993261	18-2562	31-17514A2	18-1194
27-85492-2	18-0137	27-8M0027781	18-0384	27-99506	18-0667	31-17514A2	18-4039
27-85493	18-2500	27-8M0049045	18-3877	27-995061	18-0667	31-21700	18-1095
27-85494	18-2807	27-8M0050224	18-0465	27-99757	18-2909	31-29982	18-1115
27-85495	18-2574	27-8M0077608	18-0905	27-99776	18-2508-1	31-30894A1	18-1156
27-854951	18-2574	27-8M0090319	18-2914	27-997761	18-2508-1	31-30894A5	18-1182
27-854952	18-2574	27-8M2021920	18-0398	27-99777	18-2833	31-30895	18-1157
27-85496	18-0944	27-90430	18-2803	27-997771	18-2833	31-30895T	18-1157
27-854961	18-0944	27-904301	18-2803	27-997772	18-2833	31-30956	18-1158
27-85497	18-2839	27-90458	18-0411	27-99777A1	18-4367	31-30956T	18-1158
27-854971	18-2839	27-90458A1	18-0411	27-99960	18-0389	31-32573A1	18-1142
27-854972	18-2839	27-90484	18-2502	28-43037	18-3293	31-32575A1	18-1179
27-85498	18-0107	27-904841	18-2502	28-81603M	18-3294	31-32575T1	18-1179
27-85498-1	18-0107	27-90484A32	18-4317	28-81912M	18-3305	31-32898	18-1115
27-85608	18-2914	27-90484A86	18-4317	28-83070M	18-3305	31-32898T	18-1115
27-856081	18-2914	27-90484A88	18-4317	28-83444M	18-3300	31-33138A1	18-1193
27-85609	18-2915	27-90556	18-2554	28-8M0058389	18-2375	31-35246	18-1120
27-856091	18-2915	27-91831	18-0464	29-47270	18-4036	31-35928A1	18-1159
27-85610	18-2826	27-91892	18-0185	29-71422	18-4037	31-35928T1	18-1159
27-856101	18-2826	27-92166	18-3878	29-88258	18-1186	31-35988A12	18-1160
27-85653	18-0946	27-922661	18-3878	30-17927	18-1155	31-35988A2	18-1160
27-85653-1	18-0946	27-92331	18-2717	30-20066	18-1151	31-35990A1	18-1161

*Para localizar el número de página, consulte el índice / referencia de la página 750 a 781

Mercury Marine cont.		Mercury Marine cont.		Mercury Marine cont.		Mercury Marine cont.	
31-36387A1	18-1143	32-48418	18-2126	32-8M0062309	18-3602	35-806771	18-7944
31-38356A1	18-1162	32-52481	18-70930	32-8M0062309	18-3603	35-806771	18-7945
31-42647	18-1117	32-52951A1	18-2126	32-8M0071007	18-70931	35-807172	18-7844
31-42647A1	18-1117	32-53461-70	18-7125	32-90949	18-2761	35-807172	18-7845
31-42677A1	18-1118	32-54236	18-3220	32-90949T	18-2761	35-807172	18-7944
31-43012A1	18-1195	32-55816	18-2107	32-92837	18-75125	35-807172	18-7945
31-44348001	18-2748	32-59841	18-2108	32-95858	18-2435	35-807172A4	18-7848-1
31-47245A1	18-4038	32-59841A1	18-2108	32-95859	18-2436	35-807172A4	18-7983-1
31-48939A2	18-1144	32-59842	18-2109	32-96246	18-70958	35-808275	18-7873
31-48941A1	18-1163	32-66073	18-2103	32-96246A1	18-70958	35-809097	18-7919
31-53079	18-1164	32-68676	18-2103	32-96246A4	18-70958	35-809099	18-7920
31-53079A1	18-1164	32-71613	18-70928	32-96879	18-70931	35-809100	18-7929
31-54036A1	18-1126	32-73004	18-2103	32-97153A1	18-2110	35-813405	18-7964
31-54038A1	18-1127	32-73005	18-2109	32-97154A1	18-2111	35-813405A1	18-7964
31-54042T	18-1180	32-73123	18-2108	32-99902	18-2136	35-815419	18-7964
31-54928	18-1356	32-73794	18-70929	32-99902-1	18-2114	35-816296	18-7829
31-55332A1	18-4038	32-73795	18-70927	32-99903	18-2137	35-8162961	18-7830
31-58859A1	18-4038	32-73796	18-70926	32-99903-1	18-2115	35-816296-1	18-7830
31-61100A1	18-1165	32-79431	18-2103	32-99904	18-2116	35-816296B1	18-7830
31-61424A2	18-4038	32-802885Q	18-7876	32-99904Q	18-2116	35-816296B2	18-7830
31-62596A1	18-4038	32-8066351	18-70938	35-11004A1	18-7784	35-816296K03	18-7829
31-62799A1	18-1111	32-8066361	18-70939	35-134301	18-7830	35-816296Q	18-7829
31-63075A1	18-4038	32-8066362	18-70946	35-14571A1	18-7967	35-816296Q2	18-7830
31-67526	18-1194	32-806825	18-71337	35-16248	18-7712	35-816296T	18-7829
31-67526A1	18-1194	32-806856	18-70935	35-16494	18-7829	35-816296T1	18-7830
31-67526A2	18-1194	32-807407	18-70949	35-164941	18-7830	35-816396Q1	18-7830
31-69220	18-1121	32-807458T	18-2770	35-17808A1	18-7967	35-8226267	18-7906-1
31-69220T	18-1121	32-807661	18-70950	35-184585	18-7968	35-822626K04	18-7914
31-73363	18-1122	32-807961	18-70951	35-18458A2	18-7967	35-822626Q03	18-7913
31-73363T	18-1122	32-807962	18-70951	35-18458A3	18-7967	35-822626Q04	18-7914
31-74248	18-1196	32-808033	18-70948	35-18458Q3	18-7967	35-822626Q1	18-7913
31-74248T	18-1196	32-8080441	18-70953	35-18458Q4	18-7968	35-822626Q15	18-7906-1
31-78172A1	18-1166	32-814384	18-3221	35-49088	18-7860	35-822626Q2	18-7914
31-803090T1	18-8208	32-857103K12	18-8023EP-1	35-49088A2	18-7860	35-822626T2	18-7914
31-812767A1	18-1170	32-857103Q12	18-8023EP-1	35-49088Q2	18-7860	35-822626T7	18-7906-1
31-814337A1	18-1194	32-858104K08	18-8024EP-1	35-52456	18-7944	35-853333	18-7997
31-815480	18-1189	32-858104Q08	18-8024EP-1	35-52456	18-7945	35-853333T	18-7997
31-821146A1	18-1194	32-858105K08	18-8025EP-1	35-52456A1	18-7848-1	35-864572	18-7721
31-828437A2	18-1173	32-858105Q08	18-8025EP-1	35-52456A1	18-7983-1	35-866171A01	18-7977
31-828439A2	18-1197	32-858109K12	18-8016EP-1	35-53336	18-7859	35-866340K01	18-7824-1
31-86748A1	18-1129	32-858109K12	18-8016S	35-53336Q	18-7859	35-866340Q02	18-7824-1
31-87156	18-1183	32-858109Q12	18-8016EP-1	35-55501	18-7845	35-866340Q02	18-7824-1
31-88269T	18-1347	32-858109Q12	18-8016S	35-55501	18-7944	35-866340Q02	18-7824-1
31-8M0045428	18-1194	32-858114K08	18-8012EP-1	35-55501	18-7945	35-866340Q02	18-7876
31-8M0045430	18-4039	32-858114Q08	18-8012EP-1	35-55501A1	18-7848-1	35-866340Q03	18-7824-1
31-8M0103473	18-1129	32-860089	18-70954	35-55501A1	18-7983-1	35-866340Q03	18-7876
31-92366	18-1150	32-8600891	18-70954	35-57250	18-7845	35-877565T	18-7714
31-92366A1	18-1150	32-860144	18-70940	35-57250	18-7944	35-877565T1	18-7714
31-F506818	18-1129	32-860205	18-70951	35-57250	18-7945	35-877761K01	18-7758
31-F522056	18-1121	32-860220	18-3221	35-57250A1	18-7848-1	35-877761Q01	18-7758
31-F523058	18-1158	32-86036	18-2103	35-57250A1	18-7983-1	35-877767K01	18-7921
31-F694057	18-1117	32-86036A1	18-2103	35-60494	18-7944	35-877768K01	18-7914
31-F84901	18-1162	32-86036Q	18-2103	35-60494	18-7945	35-877769K01	18-7918
31-M8004528	18-1194	32-861127	18-2435	35-604941	18-7845	35-87946A3	18-7802
32-12817	18-75125	32-861128	18-2436	35-604941	18-7944	35-87946Q3	18-7802
32-12818	18-75125	32-861590A05	18-71337	35-604941	18-7945	35-87946Q4	18-7802
32-14358	18-2746	32-861590A1	18-71337	35-60494A1	18-7848-1	35-879885T	18-7718
32-14358T	18-2746	32-861590A2	18-71337	35-60494A1	18-7983-1	35-883701K01	18-7918
32-16010	18-70933	32-861634	18-70933	35-60494A4	18-7845	35-884380T	18-7981
32-16011	18-70955	32-861635	18-44092	35-60494A4	18-7848-1	35-886638	18-7948
32-16012	18-70956	32-862124	18-70947	35-60494A4	18-7983-1	35-888289T2	18-7936
32-16021	18-70925	32-862139	18-70945	35-802884Q	18-7879-1	35-893318T01	18-7998
32-160211	18-70925	32-864588	18-2137	35-802885Q	18-7824-1	35-896247	18-7999
32-32461	18-3601	32-864589	18-2136	35-802886Q	18-7875	35-896546T	18-7921
32-32461A1	18-3601	32-864959	18-2115	35-802893A4	18-7983-1	35-8M0008397	18-7914
32-38377	18-2160	32-864960	18-2114	35-802893Q	18-7844	35-8M0020349	18-7981
32-41642A1	18-70957	32-87116	18-70925	35-802893Q	18-7944	35-8M0064104	18-7914
32-41642A3	18-70957	32-87117	18-70932	35-802893Q	18-7945	35-8M0079962	18-79911
32-4172533	18-3602	32-871171	18-70932	35-802893Q4	18-7848-1	35-8M0082290	18-79912
32-43437	18-3603	32-87234	18-2112	35-802893Q4	18-7983-1	35-8M0103095	18-7919
32-44348	18-2748	32-87235	18-2113	35-80365M	18-7713	35-93568	18-7717
32-44348T	18-2748	32-88005	18-2110	35-803897Q1	18-7784	39-15320M	18-3976
32-45327	18-2110	32-88006	18-2111	35-805369	18-7944	39-15320T	18-3976
32-45959	18-2111	32-883702K	18-7879-1	35-805369	18-7945	39-15322M	18-3978
32-45973	18-2105	32-883702Q	18-7879-1	35-8053691	18-7845	39-17464	18-3937
32-45974	18-2106	32-88795	18-75125	35-8053691	18-7944	39-17465	18-3938
32-46828	18-70933	32-887952	18-70952	35-8053691	18-7945	39-18487A12	18-3924
32-47373	18-2103	32-89653	18-70704	35-805369A4	18-7848-1	39-18653A1	18-3967
32-47640	18-70931	32-89718	18-70933	35-805809	18-7871	39-18653A2	18-3966
32-48131	18-71218	32-897181	18-70934	35-805809T	18-7871	39-18653A2	18-3968
32-48132	18-71218	32-897491	18-70943	35-806771	18-7845	39-18939M	18-3977

Mercury Marine cont.		Mercury Marine cont.		Mercury Marine cont.		Mercury Marine cont.	
39-19721A1	18-4020	43-821823A1	18-6350	46-73804A1	18-3414	47-89982	18-3052
39-19721A2	18-4021	43-823072A2	18-2407	46-73804A3	18-3517	47-89982T1	18-3252
39-19721A6	18-4019	43-828072A2	18-2206-1	46-73823A7	18-3600	47-89983	18-3007
39-34479	18-3942	43-828072A3	18-2360	46-73842A2	18-3422	47-89983Q1	18-3207
39-34988	18-3937	43-828073A1	18-2206-1	46-77177A1	18-3424	47-89983T	18-3007
39-45155A12	18-3902	43-828073A1	18-2408	46-77177A3	18-3324	47-89983T2	18-3207
39-45204A12	18-3916	43-828175A1	18-1566	46-77516A1	18-3422	47-89984	18-3017
39-48344	18-3939	43-850036	18-1560	46-77516A3	18-3322	47-899842	18-3017
39-48345	18-3938	43-850036T	18-1560	46-77822A1	18-3118	47-899844	18-3017
39-58096	18-3942	43-853640A2	18-6350	46-78400A1	18-3416	47-89984T3	18-3017
39-65153	18-3937	43-853641A2	18-6351	46-78400A2	18-3316	47-89984T4	18-3017
39-66217	18-3939	43-853642A2	18-6352	46-78400A2	18-3517	47-8M0100526	18-3265
39-67119	18-3942	43-853643A2	18-6353	46-8037502	18-43212	47-95289	18-45312
39-67123	18-3937	43-878072A3	18-2406	46-803750A02	18-43212	47-952892	18-45312
39-67126	18-3938	43-878087A2	18-2206-1	46-803750A03	18-48317	47-95611M	18-3063
39-67127	18-3940	43-878087A2	18-2360	46-803750A03	18-48317	47-96305M	18-3073
39-67132	18-3942	43-878087A2	18-2406	46-807151A12	18-36001	47-96619M	18-3074
39-74381A1	18-3928	43-878087A4	18-2407	46-807151A14	18-3150	47-97108M	18-3069
39-75422	18-3928	43-881260A3	18-1550	46-807151A7	18-3150	50-12066A1	18-4915
39-75609	18-3944	43-92320	18-2409	46-812966A7	18-3445	50-12066A9	18-4915
39-78811A12	18-3916	43-92320T	18-2409	46-812996A3	18-3445	50-12066Q9	18-4915
39-78816A12	18-3902	43-96084A4	18-2200	46-812996A9	18-3445	50-12121A2	18-6275
39-78918A4	18-3922	43-96084A5	18-2410	46-84277M	18-3148	50-12177A2	18-5910
39-81095M	18-3985	43-96084A7	18-2410	46-84277T	18-3148	50-12177A2	18-6275
39-81096M	18-3986	44-17915	18-2260	46-862914A13	18-3160	50-12872	18-5903
39-813011A12	18-3927	44-55857	18-2166	46-879194401	18-3506	50-17251A2	18-5908
39-815267A4	18-3925	44-66060	18-2166	46-96146A2	18-3416	50-17251A3	18-5908
39-817096A16	18-3919	44-660602	18-2166	46-96146A5	18-3414	50-17251A3	18-5911
39-817096A26	18-3920	44-660603	18-2166	46-96146A6	18-3416	50-22791A1	18-4915
39-817096A6	18-3918	44-824110	18-2166	46-96148A1	18-3116	50-28985A2	18-4915
39-822321A12	18-3982	44-850308	18-2254	46-96148A5	18-3517	50-38890A1	18-5601
39-822321A2	18-3984	44-94148	18-2239	46-96148A8	18-3316	50-41583	18-6828
39-824905A12	18-3982	44-98418	18-2260	46-96148A8	18-3517	50-44369	18-5606
39-826293A12	18-4051	45-42634	18-2180	46-96148T1	18-3116	50-44369A1	18-5602
39-826297A12	18-4052	45-43031A1	18-1736	46-96418	18-3116	50-44369A1	18-5606
39-827179A12	18-4050	45-440001	18-1737	47-11590M	18-3066	50-44414	18-5608
39-83196M	18-3992	45-55796	18-2179	47-16154	18-3098	50-44414	18-5608
39-85636A4	18-3923	45-557961	18-2324	47-161543	18-3098	50-44415	18-5608
39-88392	18-3917	45-816919	18-2261	47-19453	18-8900	50-44415	18-5608
39-88392A12	18-3917	45-853647	18-2331	47-20813	18-3008	50-45093	18-4915
39-93481A12	18-3921	45-853648	18-2331	47-22748	18-3012	50-47455	18-5908
39-96170A12	18-3979	46-32437A1	18-3517	47-22748	18-3447	50-55601	18-5601
39-96170A4	18-3981	46-32437A3	18-3316	47-25287	18-3008	50-55601A2	18-5601
39-97125	18-3939	46-42040A1	18-3149-1	47-30221	18-3017	50-56886	18-5903
40-52035	18-4294	46-42040A3	18-3149-1	47-39074	18-3039	50-57465A1	18-5636
43-17064A3	18-2407	46-42040A5	18-3149-1	47-420381	18-3062	50-57867	18-5636
43-18410A2	18-2201	46-42579A3	18-3419	47-420382	18-3062	50-58788A3	18-5602
43-18411A2	18-2201	46-42579A4	18-3319	47-42038Q02	18-3062	50-58788A3	18-5636
43-42933A2	18-2407	46-42579A4	18-3517	47-430261	18-3056	50-60315	18-5606
43-42933A3	18-2407	46-43024A3	18-3572	47-430262	18-3056	50-60594A	18-6824
43-45814A5	18-2203	46-44292A3	18-3420	47-430264	18-3056	50-60594A1	18-6824
43-55765A2	18-2203	46-44292A4	18-3517	47-43026Q06	18-3265	50-60594T01	18-6824
43-55765A3	18-2203	46-44292Q03	18-3420	47-43026T11	18-3214	50-64975	18-5636
43-55766A2	18-2205	46-44292T1	18-3420	47-43026T11	18-3265	50-65436	18-5642
43-55766A3	18-2205	46-46893A6	18-3447	47-43026T2	18-3056	50-65784A1	18-5908
43-55778A3	18-2205	46-48743A1	18-3116	47-43026T6	18-3214	50-66015	18-5642
43-59832A2	18-2201	46-48744A3	18-3448	47-43026T8	18-3214	50-660151	18-5610
43-59832A4	18-2201	46-48745A1	18-3422	47-56780	18-3052	50-660153	18-5610
43-61027	18-2200	46-48746A1	18-3118	47-59362	18-3087	50-66015T	18-5610
43-75325A2	18-2204	46-48746A3	18-3118	47-59362A4	18-3216	50-66015T1	18-5642
43-75325A3	18-2204	46-48747A3	18-3517	47-59362Q08	18-3318	50-67341	18-5602
43-803068T1	18-8207	46-48748A1	18-3421	47-59362T	18-3087	50-69865A1	18-5903
43-803069T1	18-2369	46-57234A1	18-3417	47-65957	18-3039	50-72467	18-5636
43-803071T1	18-2368	46-57234A3	18-3517	47-65958	18-3052	50-72550A2	18-5907
43-803079T1	18-2404	46-58618A4	18-3517	47-65960	18-3017	50-73521	18-5605
43-803091T1	18-2405	46-59112A2	18-3600	47-68988	18-3054	50-73521T	18-5605
43-803101T1	18-2259	46-60366A1	18-3507	47-72774A89	18-3155	50-76965A3	18-5908
43-803102T1	18-2358	46-60367A4	18-3517	47-80395M	18-3072	50-76965A4	18-5911
43-803103T1	18-6351K	46-63450A2	18-3600	47-81242M	18-3063	50-76967A1	18-5908
43-803104T1	18-6350K	46-64141A1	18-3116	47-81423M	18-3069	50-76967A4	18-5908
43-803105T1	18-6353K	46-64141A11	18-3517	47-81604M	18-3067	50-77141	18-5608
43-803106T1	18-6352K	46-65498A1	18-3422	47-82824M	18-3069	50-77141	18-5608
43-803112T1	18-2257	46-68390A1	18-3422	47-84027M	18-3074	50-77328A1	18-6275
43-803114T1	18-2258	46-69222A3	18-3517	47-84027T	18-3074	50-77328A3	18-5911
43-803116T1	18-2256	46-70941A3	18-3446	47-84797M	18-3067	50-77328A3	18-6275
43-803118T1	18-2363	46-72774A11	18-3600	47-85089-3	18-3057	50-79472	18-5608
43-803119T1	18-2364	46-72774A32	18-3600	47-85089T7	18-3215	50-79472	18-5608
43-803120T1	18-2365	46-73640A1	18-3423	47-85460	18-3017	50-79472 1	18-5608
43-803615T1	18-1564	46-73640A2	18-3323	47-862232A2	18-3016-1	50-79472 1	18-5608
43-803615T2	18-1551	46-73802A2	18-3416	47-89980	18-3054	50-79604A3	18-5907
43-803615T2	18-1564	46-73802A3	18-3517	47-89981	18-3039	50-801333980	18-6957

*Para localizar el número de página, consulte el índice / referencia de la página 750 a 781

Mercury Marine cont.		Mercury Marine cont.		Mercury Marine cont.		Mercury Marine cont.	
50-804312T1	18-6425	50-99419A3	18-5911	57-861049	18-15114	84-816608A14	18-8833-1
50-805833	18-6870	52-12777	18-2236	57-8610491	18-15102	84-816608A68	18-8832-1
50-805833T	18-6870	52-34239	18-2236	57-861049Q	18-15114	84-816608A71	18-8836-1
50-805991	18-6947	52-66063	18-2202	57-861050	18-15103	84-816608A81	18-8822-1
50-806963A4	18-5919	52-814756	18-2236	57-861757	18-15115	84-816608A83	18-8834-1
50-806964A2	18-6275	52-822539	18-2236	57-861757Q	18-15115	84-816608K68	18-8832-1
50-806964A3	18-6275	52-822539T	18-2236	57-861758	18-15116	84-816608Q14	18-8833-1
50-806964A4	18-6275	52-824112	18-2202	57-861758Q	18-15116	84-816608Q61	18-8804-1
50-806965A2	18-5919	52-850048T	18-1562	57-861759	18-15117	84-816608Q68	18-8832-1
50-806965A4	18-5919	52-853594	18-2202	57-862086	18-15101	84-816608Q71	18-8836-1
50-807904A1	18-6275	52-853594T	18-2202	57-8620861	18-15101	84-816608Q78	18-8824-1
50-808011A05	18-5908	52-859340T	18-1565	57-862086A1	18-15101	84-816608Q80	18-8830-1
50-808011A1	18-5908	53-29641	18-4295	57-862087A1	18-15100	84-816608Q81	18-8822-1
50-808011A3	18-5908	53-805272	18-4289	57-862088	18-15105	84-816608Q82	18-8835-1
50-808011A4	18-5603	53-815949	18-2345	57-862088A1	18-15105	84-816608Q83	18-8834-1
50-808011A4	18-5908	53-850048	18-1562	57-862089	18-15104	84-816761A12	18-8802-1
50-812428A3	18-5913	54-31765	18-710-72-2	57-862089A1	18-15104	84-816761A17	18-8821-1
50-812428A3	18-6275	54-32533	18-710-48-2	57-8623523	18-15119	84-816761A4	18-8804-1
50-812604A2	18-5913	54-38863	18-7321	57-862807	18-15100	84-816761A4	18-8821-1
50-812604A2	18-6275	54-41582-7	18-8020	57-8638761	18-15119	84-816761A7	18-8800-1
50-818445-2	18-5620	54-815504348	18-710-48-2	57-86387610	18-15122	84-816761A8	18-8809-1
50-818445-3	18-5620	54-815504372	18-7316	57-8638763	18-15100	84-816761A9	18-8803-2
50-8184455	18-5620	54-866507	18-7321	57-8638764	18-15101	84-816761K14	18-8833-1
50-819271	18-6864	54-8M0090424	18-7321	57-8638765	18-15121	84-816761Q10	18-8803-2
50-820193A1	18-6864	56-18541A75	18-2464	57-8638766	18-15102	84-816761Q12	18-8802-1
50-822330A2	18-5913	56-864641A24	18-2464	57-8638767	18-15103	84-816761Q13	18-8811-1
50-822330A2	18-6275	57-13457	18-15290	57-8638768	18-15104	84-816761Q16	18-8810-1
50-822462	18-5621	57-13457Q	18-15290	57-8638769	18-15105	84-816761Q17	18-8821-1
50-822462T1	18-5621	57-13457T	18-15290	57-864639	18-15123	84-816761Q3	18-8804-1
50-825991A2	18-6940	57-13458	18-15550	57-865423005	18-15121	84-816761Q3	18-8821-1
50-830308T	18-6437	57-13458Q	18-15550	57-865615001	18-15119	84-816761Q4	18-8804-1
50-831001562	18-6949	57-13458T	18-15550	57-865615003	18-15100	84-816761Q4	18-8821-1
50-831001671	18-6954	57-32850	18-15400	57-865615004	18-15101	84-816761Q5	18-8800-1
50-831001672	18-6954	57-32850	18-15410	57-865615005	18-15121	84-816761Q6	18-8808-2
50-831001961	18-6949	57-33170	18-15520	57-865615006	18-15102	84-816761Q7	18-8801-1
50-831002050	18-6954	57-33170Q	18-15520	57-865615007	18-15103	84-816761Q8	18-8809-1
50-831002051	18-6954	57-36356	18-15415	57-865615008	18-15104	84-816761Q9	18-8803-2
50-831002052	18-6954	57-37619T	18-15520	57-865615009	18-15105	84-821945A56	18-28080
50-8329972	18-6282	57-45856	18-15440	57-865615010	18-15122	84-822253A20	18-5511
50-8331535	18-6283	57-48120	18-15460	57-865615Q01	18-15119	84-822253T20	18-5511
50-834749	18-6436	57-48120A1	18-15460	57-865615Q03	18-15100	84-847701A7	18-8837-1
50-852570	18-6829	57-48120Q1	18-15460	57-865615Q04	18-15101	84-847701Q7	18-8837-1
50-852570T	18-6829	57-48122	18-15480	57-865615Q05	18-15121	84-863656A1	18-8828-1
50-853329T	18-6440	57-48122Q	18-15480	57-865615Q06	18-15102	84-863656A2	18-8829-1
50-854178	18-6957	57-49043	18-15410	57-865615Q07	18-15103	84-881262A2	18-6500
50-854636T	18-6438	57-49043A1	18-15410	57-865615Q08	18-15104	84-881698	18-8838-1
50-855507	18-6957	57-49211	18-15430	57-865615Q09	18-15105	84-881908T	18-28083
50-857065	18-6829	57-49211	18-15435	57-865615Q10	18-15122	84-881908T	18-28084
50-859168	18-6829	57-49213A1	18-15440	57-880566014	18-15128	84-881908T	18-28085
50-859168T	18-6829	57-49756	18-15300	57-881754	18-15124	84-881908T	18-28086
50-859169T	18-6437	57-52692	18-15390	57-892318	18-18000	84-90816A26	18-5225
50-859170T	18-6438	57-53215	18-15290	57-91035	18-15495	84-93212A1	18-5225
50-859171T	18-6436	57-53215T	18-15290	57-91035A1	18-15495	84-93475A26	18-5225
50-859377T	18-6435	57-64032	18-15410	57-91035Q1	18-15495	84-99215A26	18-5225
50-863007A1	18-6275	57-64032A1	18-15410	57-96834	18-15550	87-17009A2	MP41070-2
50-864340A2	18-5913	57-64032Q1	18-15410	57-96834Q	18-15500	87-17009A5	MP51090
50-864340A2	18-6275	57-64416	18-15430	57-96834T	18-15500	87-17009A5	MP51092
50-86976	18-5609	57-64416	18-15435	81-64851	18-5346	87-18211	18-5729
50-86976	18-6825	57-65607	18-15370	84-43376A12	18-8802-1	87-19761	18-5737
50-884044T	18-6435	57-65607Q	18-15370	84-43376A7	18-8800-1	87-71831	18-5317
50-884045T	18-6438	57-65607T	18-15370	84-43376A8	18-8809-1	87-861780A2	18-5116-1
50-888151T	18-6437	57-69143Q	18-15400	84-43376A9	18-8803-2	87-861780Q4	18-5116-1
50-888160T	18-6438	57-69143T	18-15400	84-813706A26	18-5225	87-88107	MP41000
50-888161T	18-6435	57-74271	18-15345	84-813706A56	18-28081	87-88107A5	MP52000
50-892339T	18-6440	57-74271Q	18-15345	84-813715A1	18-5227-1	87-88107A5	MP52002
50-893890T	18-5621	57-74271T	18-15345	84-813715A1	18-5228-1	87-892150A02	18-5116-1
50-893891T	18-5602	57-76269	18-15405	84-813715A8	18-28082	88-79023A91	18-8220
50-893892T	18-5610	57-76269Q	18-15405	84-813720A10	18-8803-2	88-93582	18-15501
50-893894	18-6943	57-77274	18-15345	84-813720A11	18-8810-1	89-15857	18-5815
50-897755T	18-6840	57-77274A1	18-15325	84-813720A12	18-8802-1	89-18080	18-5837
50-898265005	18-5605	57-78200	18-15470	84-813720A13	18-8811-1	89-33316	18-5837
50-8M0033984	18-5611	57-78200A1	18-15470	84-813720A2	18-8804-1	89-60687	18-5837
50-8M8021116	18-6946	57-78200Q1	18-15470	84-813720A3	18-8804-1	89-61053	18-5815
50-90983A1	18-5611	57-8077554	18-15112	84-813720A3	18-8821-1	89-65258	18-5815
50-90983T1	18-5611	57-8077555	18-15113	84-813720A4	18-8804-1	89-68258A4	18-5815
50-97499A2	18-5907	57-807755Q04	18-15112	84-813720A4	18-8821-1	89-76416A1	18-5801
50-97499R4	18-5907	57-816295Q	18-15490	84-813720A5	18-8800-1	89-76545	18-5815
50-99417A2	18-5911	57-816295T	18-15490	84-813720A6	18-8808-2	89-76545T	18-5815
50-99418A2	18-5910	57-816544	18-15410	84-813720A7	18-8801-1	89-817109A2	18-5834
50-99418A2	18-6275	57-817113	18-15125	84-813720A8	18-8809-1	89-818864	18-5818
50-99419A3	18-5908	57-828507Q4	18-18100	84-813720A9	18-8803-2	89-818864T	18-5818

*Para localizar el número de página, consulte el índice / referencia de la página 750 a 781

Mercury Marine cont.		Mercury Marine cont.		Mercury Marine cont.		Mercury Marine cont.	
89-818997A1	18-5819	91-47448A1	18-9896	92-802859A1	18-9240-0	97-821630Q1	18-6094
89-818997A2	18-5819	91-48347	18-4442	92-802863A1	18-9240-1	97-826134Q	18-6068
89-818997T1	18-5819	91-52393	18-9848	92-802881A1	1525607	97-888755Q03	18-6158M
89-818999A2	18-5820	91-52394	18-9849	92-802882A1	37534	97-888756Q03	18-6158A
89-825096T	18-5821	91-53459	18-9850	92-809056979	22423	97-888758Q03	18-6159A
89-825842A1	18-5820	91-55916	18-9851	92-809819	37478	97-888759Q03	18-6159M
89-850188T1	18-5820	91-55918	18-9852	92-809820	37479	97-888760Q03	18-6160M
89-853654A1	18-5815	91-56048001	18-9853	92-809824	37509	97-888761Q03	18-6160A
89-89902	18-5837	91-56048T	18-9853	92-81639A4	18-9200-1	227-64818	18-2614
89-91975	18-5816	91-56775T	18-9854	92-817529A12	18-9013	227-845628	18-1232
89-96054	18-5816	91-57797A1	18-4442	92-817529A12	18-9024	332-4911A2	18-5786
89-96054T	18-5816	91-57797A2	18-4442	92-817529A12	18-9065	332-4911A5	18-5787
89-96158	18-5817	91-57797A3	18-4442	92-817529A12	18-9080	332-4911A8	18-5787
89-96158T	18-5817	91-60523	18-9855	92-823506 1	37534	332-5524A1	18-5775
89-99253	18-5837	91-60526T	18-9856	92-857389A1	18-9400-4	332-5772A1	18-5881
91-12037	18-9806E	91-61067A3	18-9857	92-857389A1	18-9400-4P	332-5772A2	18-5881
91-12427	18-9807	91-61069T	18-9858	92-858007Q01	18-9600-5	332-5772A3	18-5881
91-12427T	18-9807	91-61077	18-9868	92-858007Q01	18-9600-5P	332-5772A5	18-5881
91-14311A04	18-9874	91-63616	18-9859	92-858008Q01	18-9650-5	332-7778A1	18-5775
91-14311A1	18-9874	91-63638T	18-9860	92-858008Q01	18-9650-5P	332-7778A12	18-5775
91-14311A2	18-9874	91-74057Q6	18-9782	92-858037K01	18-9530-3	332-7778A3	18-5775
91-15755	18-9808	91-74057Q6	18-9783	92-858039K01	18-9530-7	332-7778A6	18-5775
91-15755T	18-9808	91-75132	18-9896	92-858042K01	18-9553-3	332-7778A7	18-5775
91-17256	18-9803	91-78310	18-9861	92-858042Q01	18-9553-3	332-7778A9	18-5775
91-17257	18-9809	91-805475A1	18-4442	92-858057K01	18-9440-7	336-3948A2	18-5139
91-17262A1	18-9810	91-813653	18-9873	92-858057K01	18-9440-7P	336-3948A3	18-5139
91-17275A1	18-9812	91-817570T	18-9869	92-858058Q01	18-9600-2	336-3996A7	18-5855
91-17302	18-9813	91-818162	18-9870	92-858058Q01	18-9600-2P	336-4318A2	18-5139
91-23033	18-9817	91-818169T	18-9871	92-858061Q01	18-9600-6	336-4318A3	18-5139
91-23033T	18-9817	91-821571A1	18-9872	92-858062Q01	18-9600-7	336-4318A4	18-5139
91-24150	18-9817	91-821887A1	18-4459	92-858062Q01	18-9600-7P	339-6222A8	18-5788
91-29310	18-9814	91-850730Q01	18-9781	92-858064Q01	18-9650-2	339-7370A13	18-5186
91-30366T1	18-9816	91-859046Q4	18-4459	92-858064Q01	18-9650-2P	339-7452A1	18-5776
91-30500	18-9785	91-859046T4	18-4459	92-858067Q01	18-9650-6	339-7452A11	18-5778
91-31107	18-9817	91-87119	18-9862	92-858067Q01	18-9650-6P	339-7452A14	18-5778
91-31107T	18-9817	91-878232	18-9896	92-858068Q01	18-9650-7	339-7452A15	18-5777
91-31108	18-9818	91-879172T28	18-79816	92-858068Q01	18-9650-7P	339-7452A19	18-5777
91-31108T	18-9818	91-883704Q03	18-9794	92-858084K01	18-9552-3	339-7452A2	18-5776
91-31109	18-9808	91-895343A02	18-9897	92-877770K1	18-9300	339-7452A21	18-5778
91-31229	18-9819	91-895343T01	18-9897	92-877770K1	18-9305	339-7452A3	18-5776
91-31229A7	18-9820	91-895343T02	18-9897	92-883722K01	18-9440-8	339-7452A7	18-5777
91-32325	18-9821	91-896661	18-79814	92-883723K01	18-9440-3	339-7452A8	18-5778
91-32325T	18-9821	91-89865	18-9863	92-883724K01	18-9440-2	339-7452A9	18-5777
91-32336	18-9822	91-89897	18-9866	92-883724K01	18-9440-2P	339-832757A4	18-5186
91-33489	18-9823	91-8M0067546	18-4442	92-883725K01	18-9440-4	339-850227	18-5187
91-33491	18-9824	91-8M0072133	18-9781	92-883725K01	18-9440-4P	339-856991A1	18-5187
91-33492	18-9825	91-90244A1	18-9875	92-8M0062765	18-8606	339-859738T1	18-23205
91-33492T	18-9825	91-90455	18-9896	92-8M0078618	18-9420CAT-7	391-5075	18-5376
91-33493	18-9826	91-904551	18-9896	92-8M0078618	18-9420CAT-7P	391-5075Q1	18-5376
91-33493T	18-9826	91-90455T	18-9896	92-8M0078621	18-9400CAT-7	391-5076	18-0422
91-34379T	18-9827	91-90455T1	18-9896	92-8M0078621	18-9400CAT-7P	391-5088	18-5404-1
91-36235	18-9803	91-90774	18-9865	92-8M0078624	18-9440CAT-7	391-5090	18-5314
91-36379	18-9828	91-95830	18-4444	92-8M0078624	18-9440CAT-7P	391-5092	18-5338
91-36569	18-9829	91-95830A1	18-4444	92-8M0078625	18-9420CAT-2	391-5092	18-5338
91-36569T	18-9829	91-99379	18-9802	92-8M0078625	18-9420CAT-2P	391-5093	18-5338
91-36571	18-9830	91-99750A1	18-9801	92-8M0078626	18-9420CAT-3	391-7057	18-5404-1
91-36571T	18-9830	91-99750A1	18-9801	92-8M0078626	18-9420CAT-3P	391-7057T	18-5404-1
91-36577	18-9831	92-12564 2	22423	92-8M0078627	18-9400CAT-2	391-898253001	18-5338
91-36577T	18-9831	92-12564-1	22423	92-8M0078627	18-9400CAT-2P	391-898253004	18-5314
91-37263	18-9808	92-34227	1525607	92-8M0078629	18-9440CAT-2	391-898253029	18-5404-1
91-37292	18-9832	92-34227T1	1525607	92-8M0078629	18-9440CAT-2P	392-2529	18-6256
91-37311	18-9833	92-34227Q02	1525607	97-31640B4	18-6011	392-2940	18-6254
91-37312	18-9834	92-41669-1	37534	97-31640Q4	18-6011	392-6318	18-5369
91-37323	18-9835	92-59327-1	37509	97-34672C	18-6013	392-6318T	18-5369
91-37324	18-9815	92-730611	22423	97-762145	18-6016	392-6324	18-5347
91-37350	18-9836	92-755051	22423	97-76214Q5	18-6016	392-6325	18-5303
91-37384	18-4442	92-78383A12	18-9013	97-806188A1	18-6117A	392-6326	18-5407
91-38277A1	18-4444	92-78383A12	18-9024	97-806188A1	18-6117M	392-6326T	18-5407
91-38628T	18-9837	92-78383A12	18-9065	97-806188A1	18-6117Z	392-6329	18-5399
91-38756	18-9838	92-78383A12	18-9080	97-806188Q01	18-6117A	392-7803A4	18-5438
91-38918T	18-9839	92-802833Q1	18-9420-2	97-806188Q01	18-6117M	392-805570A2	18-5438
91-38919	18-9840	92-802833Q1	18-9420-2P	97-806188Q01	18-6117Z	392-806529A1	18-5433
91-42840T	18-9841	92-802835Q1	18-9420-3	97-806189	18-6067	392-825101	18-5180
91-43506T	18-9842	92-802835Q1	18-9420-3P	97-806189	18-6067A	392-825101T	18-5180
91-43559	18-9843	92-802836A1	18-9420-7	97-806189Q1	18-6067	392-8261A1	18-6768
91-43578A1	18-9864	92-802836A1	18-9420-7P	97-806189Q1	18-6067A	392-8261A1	18-6799
91-43579	18-9844	92-802837Q1	18-9400-2	97-806190	18-6089	392-8263	18-6768
91-43591T	18-9845	92-802837Q1	18-9400-2P	97-806190B4	18-6089	392-8263	18-6799
91-44110	18-9846	92-802841A1	18-9400-7	97-806190Q1	18-6089	392-863704T ss	
91-44307A1	18-9874	92-802841A1	18-9400-7P	97-821629Q1	18-6080	8M0054588	18-5465
91-45497A1	18-9847	92-802844Q02	18-9600-0	97-821629Q1	18-6099	392-881732	18-7648

*Para localizar el número de página, consulte el índice / referencia de la página 750 a 781

Mercury Marine cont.		Mercury Marine cont.		Mercury Marine cont.		Mercury Marine cont.	
392-898253002	18-5347	735-850097	18-4173	938-884741R50	18-4485	1396-4656	18-7081
392-898253005	18-5303	735-850098	18-4164	1337-2103	18-7078	1396-5222	18-7096
392-8989	18-6255	735-9431	18-4164	1337-2604	18-7078	1396-5238	18-7096
392-9086	18-5353	735-9686	18-4173	1346-2770	18-7080	1397-2060	18-7200
392-9086T	18-5353	735-9687	18-4164	1347-804623A1	18-7605-1	1397-2067	18-7746
392-9089	18-5403	735-9703	18-4173	1347-804623R02	18-7604-1	1397-2072	18-7070
392-9089Q	18-5403	735-9704	18-4164	1347-804623R02	18-7605-1	1397-2133	18-7078
392-9089T	18-5403	735-9715	18-4178	1347-804623R1	18-7604-1	1397-2150	18-7855
392-9766	18-5352	735-97151	18-4178	1347-804624 R02	18-7615-1	1397-2605	18-7078
392-9766Q1	18-5352	735-9715T1	18-4178	1347-804624 R1	18-7618-1	1397-2631	18-7746
392-9766T	18-5352	736-2343	18-4180	1347-804624R02	18-7618-1	1397-2634	18-7746
392-9767	18-5403	737-6523	18-4189	1347-804624R1	18-7615-1	1397-2637	18-7070
393-3230	18-5389	737-879194035	18-4189	1347-804625R02	18-7617-1	1397-2637	18-7746
393-4988	18-5389	743-3193A2	18-4620	1347-804625R1	18-7617-1	1397-3306	18-7072
393-4988T	18-5389	743-3193A4	18-4620	1347-804626 R02	18-7616-1	1397-3327	18-7201
393-4988T2	18-5389	743-3366A1	18-4621	1347-816373A4	18-7615-1	1397-3458	18-7071
393-9459	18-5385	743-3366A2	18-4621	1347-818619	18-7609-1	1397-3459	18-7746
393-9459Q1	18-5385	743-5172A6	18-4620	1347-818619 1	18-7609-1	1397-3462	18-7078
393-9459T	18-5385	743-7716A2	18-4622	1347-818619 1R02	18-7609-1	1397-3464	18-7070
394-1100A2	18-5148	759-592010	18-4109	1347-818620	18-7608-1	1397-3464	18-7746
394-1100A3	18-5148	759-592012	18-4134	1347-818620 1	18-7608-1	1397-4329	18-7072
394-1130	18-5169	759-661010	18-4109	1347-818620R02	18-7608-1	1397-5635	18-7072
394-1130A1	18-5169	759-661012	18-4134	1347-818621	18-7610-1	1397-5830	18-7075
394-352A1	18-5148	759-80661A3	18-4109	1347-818621 1	18-7610-1	1397-5831	18-7075
397-359	18-5169	759-80661A7	18-4109	1347-818621 1R02	18-7610-1	1397-5837	18-7202
397-741	18-5169	759-80661A8	18-4134	1347-818622	18-7603-1	1397-6367	18-7076
398-173	18-5178	759-80661A5	18-4134	1347-818622 1	18-7603-1	1397-6367A1	18-7076
398-174	18-5153	759-831210	18-4109	1347-818622R02	18-7603-1	1397-6638	18-7072
398-2202	18-5140	759-831212	18-4134	1347-8288A1	18-7616-1	1397-7099	18-7075
398-5255	18-5856	759-8312A2	18-4109	1347-8289A1	18-7618-1	1397-7539	18-7095
398-5454A17	18-5854	759-8312A6	18-4134	1347-8460A3	18-7619-1	1397-7540	18-7095
398-5454A21	18-5874	759-9015A4	18-4134	1347-9142A2	18-7619-1	1397-7542	18-7070
398-5454A22	18-5859	761-7131M	18-4135	1347-9661A3	18-7605-1	1397-7542	18-7746
398-5454A25	18-5874	761-7133M	18-4135	1347-9863A3	18-7617-1	1397-7543	18-7070
398-5454A32	18-5871	761-7134M	18-4135	1356-4066	18-7096	1397-7543	18-7746
398-5454A35	18-5860	761-7196M	18-4138	1356-4092	18-7096	1397-7544	18-7095
398-5454A63	18-5874	761-7197M	18-4138	1356-5155	18-7096	1397-7547	18-7746
398-5454A7	18-5857	761-7198M	18-4138	1356-5169	18-7096	1397-8535	18-7095
398-5704A7	18-5865	761-7982M	18-4135	1376-5659A1	18-7603-1	1397-8545	18-7869
398-5919A2	18-5874	761-7982T	18-4135	1389-815396A2	18-7370N	1397-8546	18-7201
398-5919A3	18-5859	761-8022M	18-4136	1389-8490A2	18-7370N	1397-8582	18-7666
398-5919A6	18-5874	761-8484M	18-4138	1389-9350A2	18-7370N	1397-8760	18-7075
398-5919A7	18-5859	765-7443A11	18-4013	1389-9562A1	18-7370N	1397-8767	18-7869
398-5919A8	18-5874	765-7443A12	18-4560	1395-4808	18-7006-1	1397-8872	18-7070
398-6231A10	18-5872	765-7443A2	18-4560	1395-6200	18-7004	1397-8872	18-7746
398-693	18-5206	765-7446A11	18-4014	1395-6452	18-7005	1397-8873	18-7746
398-713	18-5207	766-8667A36	18-4565	1395-7824	18-7233	1397-8952	18-7077
398-716	18-5178	766-8667A43	18-4565	1395-811222	18-7750-1	1397-8959	18-7201
398-818535A15	18-5874	774-9096A1	18-4530	1395-8112231	18-7211-1	1397-9723	18-7095
398-832075A14	18-5874	774-9137A10	18-4515	1395-811357	18-7212	1398-3089	18-7080
398-832075A20	18-5874	774-9137A11	18-4530	1395-811691 2	18-7355	1399-1136	18-7832
398-832075A21	18-5870	774-9137A14	18-4535	1395-811691 3	18-7356	1399-1138	18-7057
398-832075A4	18-5870	776-8898A2	18-4535	1395-823635	18-7750-1	1399-1473	18-7057
398-832075A6	18-5873	776-9096A1	18-4156	1395-8236351	18-7750-1	1399-1717	18-7006-1
398-9610A19	18-5876	777-815965A4	18-4623	1395-8236352	18-7750-1	1399-1754	18-7832
398-9873A4	18-5867	777-815965A5	18-4624	1395-8236353	18-7750-1	1399-2015	18-7006-1
66L-13915-00-00	18-79901	777-815965A6	18-4625	1395-8236354	18-7750-1	1399-3523	18-7006-1
700-858294T1	18-4639	777-815965T4	18-4623	1395-8318	18-7061	1399-3938	18-7832
700-858295T1	18-4640	778-9015A2	18-4109	1395-83181	18-7061	1399-5135	18-7007
700-878571A2	18-4641	778-9441A3	18-4109	1395-8506	18-7354	1399-5137	18-7815
700-878572A2	18-4642	778-9441A5	18-4134	1395-8673	18-7208	1399-5198	18-7007
700-878573A2	18-4643	780-9229A10	18-4621	1395-879194024	18-7006-1	1399-5207	18-2910
700-878574A2	18-4644	780-9229A11	18-4622	1395-8983	18-7208	1399-99	18-2575
733-2278	18-4180	780-9229A7	18-4620	1395-9022	18-7295	1547-3917A13	18-2450
733-3818	18-4160	783-9613A2	18-4017	1395-9024	18-7215	1547-3917A16	18-2451
733-38181	18-4160	783-9613A3	18-4018	1395-9179	18-7212	1547-3917A21	18-2450
733-3819	18-4161	783-9613T2	18-4017	1395-9258	18-7057	1547-3917A30	18-2451
733-3819	18-4191	783-9613T3	18-4018	1395-9258 1	18-7057	1547-3917A32	18-2450
733-38191	18-4191	785-9737A10	18-4637	1395-9267	18-36956	1547-3917A37	18-2450
733-4028	18-4161	785-9737T9	18-4635	1395-9293	18-7209	1547-3917A38	18-2451
733-4028	18-4191	785-9738T10	18-4638	1395-9377	18-7212	1547-3917A4	18-2451
733-66217	18-4180	785-9738T9	18-4636	1395-9594	18-72000	1547-3917A8	18-2451
733-803850T	18-4161	936-810840	18-4489	1395-95951	18-7062	1547-5523A11	18-2451
733-803850T	18-4191	936-986767	18-4489	1395-9599	18-7750-1	1547-5523A12	18-2450
735-6370	18-4173	938-803860T	18-4486	1395-9645	18-7212	1547-5523A2	18-2450
735-6370	18-4173	938-827178	18-4491	1395-9650	18-7226	1547-5523A49	18-2453
735-6371	18-4164	938-883297 1	18-4486	1395-9725	18-7212	1547-5523A67	18-2452
735-6538	18-4181	938-883490	18-4485	1395-9761	18-7212	1547-5523A67	18-2453
735-808661	18-4173	938-883490R1	18-4485	1395-97611	18-7212	1547-5523A68	18-2450
735-808674	18-4173	938-883490R50	18-4485	1395-9803	18-7212	1547-5523A8	18-2451
735-808674A1	18-4173	938-884741R	18-4485	1396-4148	18-7227	1547-5523A9	18-2450

Mercury Marine cont.		Mercury Marine cont.		Mercury Marine cont.		Mercury Marine cont.	
1547-815930A13	18-2419	3310-864942A01	18-7375N	35915	18-3759	57882	18-7232
1547-815930A14	18-2418	3310-864943A01	18-7376N	35957	18-3593	58033	18-5318
1547-815930A15	18-2417	3310-864943A01	18-7639	35983	18-4296	58034	18-5346
1547-815930A16	18-2416	3310-866142A03	18-79994N	35992	18-3752	58086	18-3584
1547-815930A3	18-2419	3310-866142A04	18-79994N	36147	18-2101	58217	18-5418
1547-815930A4	18-2418	3310-866143A03	18-79995N	36223	18-2752	58231	18-5315-1
1547-815930A5	18-2417	6325	18-5345	36312	18-2104	58749	18-2104
1547-815930A6	18-2416	12415	18-5896	36312	18-2174	58749	18-2174
1547-8265A15	18-2450	12449	18-5957	36525	18-5897	59078	18-3550
1547-8265A16	18-2451	12449	18-5965	37369	18-3575	59137	18-3551
1547-8265A17	18-2452	12449	18-5966	37369	18-3593	59341	18-1213
1547-8265A17	18-2453	12708	18-1240	37721	18-0539	59755	18-5956
1547-861063A10	18-2417	12784	18-6400	37951	18-3599-1	59755	18-5957
1547-861063A12	18-2416	13037	18-5804	37967	18-2196	59755	18-6841
1547-861063A4	18-2411	13220	18-7751	37973	18-2150	59755	18-6842
1547-861063A6	18-2419	14244	18-0616	38463	18-7878-1	59972	18-3577-1
1547-861063A8	18-2418	14259	18-0612	38547	18-5433	60207	18-4008
1547-9412A20	18-2450	14586	18-3549	39383	18-2128	60252	18-4009
1547-9412A21	18-2451	14698	18-2373	39384	18-2125	60565	18-7875
1547-9412A22	18-2452	14760	18-0615	39920	18-1973	60658	18-3583
1547-9412A23	18-2453	14957	18-7824-1	41431	18-2104	60658	18-3599-1
1547-9412A30	18-2450	14957	18-7876	41431	18-2174	60930	18-2727
1547-9412A35	18-2450	16253	18-7381	41639	18-7230	61073	18-2196
1547-9412A36	18-2452	16755	18-2516	41815	18-7879-1	61851	18-1906
1623-4110A13	18-2443	16755	18-2615	42785	18-5740	62092	18-7267
1623-4110A4	18-2443	17340	18-1400	42838	18-8305	62092	18-7267
1623-4110A6	18-2443	17437	18-3583	43433	18-2149	62104	18-2322
1623-5356A18	18-2443	17437	18-3599-1	43436	18-3754	62424	18-5315-1
1623-5356A19	18-2443	17646	18-6771	43557	18-5395	62981	18-3553
1623-5356A20	18-2443	17649	18-6772	43585	18-1730	63196	18-7275
1623-5356A3	18-2443	17670	18-3577-1	43713	18-2724	64850	18-5317
1623-5356A4	18-2402	18525	18-6771	45523	18-2148	65028	18-2150
1623-815822A3	18-2400	18717	18-8309	45876-20	18-5511	65057	18-5802
1623-815822A32	18-2400	19273	18-7249	46020	18-2125	65142	18-3575
1623-815822A36	18-2415	19643	18-4261	46472	18-1402	65142	18-3593
1623-815822A5	18-2400	20121	18-5224	46692	18-7878-1	65547	18-1705
1623-815822A53	18-2400	20175	18-2146	46744	18-1402	65864	18-5420
1623-8951A14	18-2443	22879	18-2149	46860	18-7275	66062	18-2130
1623-8951A15	18-2401	25661	18-5836	46895	18-3139	66066	18-2150
1623-8951A19	18-2443	29196	18-8070	47441	18-1977-1	66067	18-2286
1623-8951A2	18-2443	29196	18-8084	47585	18-7278	66071	18-3752
1623-8951A23	18-2443	29880	18-2149	47587	18-1910	66850	18-3553
1623-8951A27	18-2401	30605	18-3117	47587	18-1993	67209	18-2144
1623-8951A37	18-2401	31640	18-6011	47588	18-1910	67210	18-2143
1623-8951A43	18-2443	31640	18-6011A	47588	18-1993	67859	18-3577-1
1623-8951A5	18-2401	31640	18-6241	47594	18-3557	68100	18-2342
1647-9148R84	18-4851	31659	18-2753-2	47638	18-1995	68575	18-5656
1647-9148T93	18-4832	32170	18-6013	47886	18-5808	69668	18-8305
1667-9011G59	18-4830	32435	18-3117	48045	18-1990	69729	18-5950
1667-9011G59	18-4830	32489	18-3219	48752	18-3114	69729	18-5956
1667-9011R6	18-4850	32716	18-7824-1	48753	18-3115	69729	18-5957
1667-9011R6	18-4850	32716	18-7876	49117	18-1402	69729	18-6841
2704-812896A2	18-4626	32717	18-7824-1	49139	18-3577-1	69729	18-6842
2704-821896A3	18-4627	32717	18-7876	52022	18-7824-1	70125	18-7665
2704-821896A4	18-4628	32722	18-7256	52022	18-7876	70977	18-3113
2704-821896A6	18-4626	32728	18-3551	52226	18-3599-1	70981	18-2762
2704-826191A4	18-4626	32734	18-2750	52352	18-5315-1	71327	18-7278
2704-826191A6	18-4626	32768	18-3107	52353	18-3575	71464	18-7667
2704-826191T4	18-4626	33149	18-2193	52353	18-3593	71646	18-7274
3302-804844	18-7098-1	33261	18-5838	52444	18-7848-1	71683	18-3584
3302-804844001	18-7098-1	33266	18-5315-1	52731	18-7824-1	72625	18-7667
3302-804844002	18-7098-1	33270	18-5717	52731	18-7876	72638	18-1402
3302-804845	18-7097	33662	18-5345	52999	18-4009	72777	18-3351
3302-9031	18-7202	33667	18-5385	53114	18-2759	72778	18-3350
3302-9033	18-7859	33700	18-5310	54111	18-7824-1	73345	18-4233
3302-9437	18-7097	33706	18-5344	54111	18-7876	73813	18-1990
3303-895110T01	18-34500	33707	18-5300	54534	18-3577-1	73873	18-8227
3304-9354A2	18-7604-1	33708	18-5384	54552	18-7267	74639	18-2753-2
3310-806077A2	18-7370N	33765	18-5386	54705	18-3107	75384	18-5697
3310-806078A2	18-7370N	33957	18-3575	54793	18-3599-1	75639	18-0615
3310-806969 R01	18-7613-1	33981	18-2162	54870	18-1990	75661	18-5674
3310-806969A1	18-7613-1	33981	18-2162E	54981	18-5802	75692	18-3553
3310-807312 R02	18-7611-2	34127	18-6012	55481	18-7853-1	75832	18-2104
3310-807312A1	18-7611-2	34235	18-5311	55989	18-60151-9	75832	18-2174
3310-807826A1	18-79997	34282	18-1402	56045	18-5956	76214	18-6016
3310-818660A1	18-79996	34623	18-5899	56045	18-5957	76214	18-60161
3310-860070A2	18-7370N	34625	18-5898	56045	18-6841	76214	18-6016A
3310-861245A1	18-7376N	35329	18-4492	56045	18-6842	76214	18-6244
3310-861448A1	18-7375N	35341	18-3599-1	56153	18-1401	76270	18-3552
3310-861448A1	18-7375N	35583	18-1402	56879	18-3584	76865	18-2130
3310-864941A01	18-7373N	35884	18-3551	57380	18-5650	77123	18-1705

*Para localizar el número de página, consulte el índice / referencia de la página 750 a 781

Mercury Marine cont.		Mercury Marine cont.		Mercury Marine cont.		Mercury Marine cont.	
77326	18-2144	803743	18-73890	853292	18-5852	811637002	18-5107-1
77443	18-2148	804184	18-7382	853998	18-7690	833072002	18-3537
77481	18-2150	804412	18-5107-1	854445	18-7668	833072003	18-3536
77594	18-7278	804418	18-5354	858763	18-7083	833072004	18-3537
78016	18-5420	804424	18-5408	859168	18-6829	850055001	18-3534
78249	18-2143	805100	18-3784	861249	18-7550	850399002	18-3599-1
78458	18-2760	805629	18-5021	861260	18-7692	850454002	18-3577-1
78477	18-5956	806105	18-6079	861425	18-7551	855676002	18-43175
78477	18-5957	806105	18-6093	861578	18-8297	864297001	18-7556
78477	18-6841	806105	18-6093A	862129	18-1709	879150150	18-7682
78477	18-6842	806189	18-6114	862130	18-1709	879194024	18-7006-1
78485	18-7274	806190	18-6092	862131	18-1709	879194241	18-7964
78687	18-2144	806190	18-6092A	862132	18-1711	881693002	18-7698
78820	18-7275	806490	18-5897	862209	18-1710	884727001	18-3575
79223	18-1213	807057	18-5851	862615	18-7646	884727001	18-3593
79448	18-3751	808483	18-5354	862998	18-7701	885599004	18-3535
81977A8-A9	18-6777	808484	18-5405	863416	18-31103	892615001	18-7646
85552	18-2742	808500	18-2641	864493	18-43015	892615002	18-7646
85785-2	18-7229	809064	18-7748	878187	18-7554	898253003	18-5345
86177	18-5658	809065	18-7749	878341	18-3599-1	898253005	18-5345
86234	18-7278	809066	18-7664	878342	18-3577-1	898253007	18-5318
86246	18-7274	809462	18-5811	879036	18-2830-1	898253008	18-5418
86247	18-7275	809463	18-5811	879078	18-9099	898253009	18-5402
86459	18-9099	809569	18-7380	879366	18-1194	898253010	18-5405
86814	18-1710	809910	18-0612	880817	18-3575	898253011	18-5406
87581	18-5315-1	811091	18-5897	880817	18-3593	898253012	18-5408
88035	18-2372	811536	18-36906	881540	18-7979	898253013	18-5245
88726	18-8305	811549	18-0614	881731	18-7660	11497M	18-7833
89876	18-7853-1	811573	18-3577-1	882571	18-6948	11502M	18-7765
89902	18-5838	811618	18-6751	883514	18-3573	12076A1	18-1975-1
90794	18-5956	811628	18-6774	883885	18-3584	12076A2	18-1975-1
90794	18-5957	811635	18-5361	883925	18-3573	12449A1	18-5957
90794	18-6841	811636	18-5406	884727	18-3593	12449A1	18-5965
90794	18-6842	811637	18-5107-1	884790	18-5245	12449A1	18-5966
90806	18-5899	811639	18-5108	884792	18-5244	12449A1	18-5966
90880	18-1905	811841	18-3599-1	885174	18-7662	12632A2	18-2175
92497	18-5957	814472	18-6275	885176	18-7688	12632A3	18-2195
92497	18-5965	814755	18-3575	888731	18-5243	12632A4	18-2175
92497	18-5966	814755	18-3593	892681	18-33211	12632A4	18-21751
92802	18-2733	815279-1	18-5741	893409	18-3607	12632A6	18-2321
93320	18-1908	815279-3	18-5743	895338	18-3556	12632A7	18-2195
93322	18-1985	815279-5	18-5743	934231	18-3199	12644A1	18-4457
93322	18-1985	815425	18-5899	934233	18-3199	12644Q01	18-4457
93423	18-3199	815471	18-2145E	934241	18-3198	12784A10	18-6401
93424	18-3198	816597	18-3151	934243	18-3198	12784A4	18-6401
93476	18-0613	816607	18-1728	1100990	18-0980	12784T	18-6400
93477	18-0615	816685	18-3749	4602002	18-2125	13191A1	18-4221
94318	18-5817	816770	18-5707	8052732	18-3649	13310T1	18-5674
94576	18-3350	816877	18-7083	8055361	18-2097	13330A3	18-8005EP-1
94916	18-3351	817276	18-3122	8072521	18-3551	13330A3	18-8005S
97257	18-5897	817377	18-5475	8072522	18-3649	13330Q	18-8005S
97258	18-5898	817378	18-5443	8072531	18-3551	13447A1	18-5313-1
97351	18-2707	819762A4-A7	18-6777	8094621	18-5811	13524A4	18-5432
97355	18-1213	821509	18-5852	8094631	18-5811	13524A5	18-5431
97399	18-7288-1	821629	18-6080A	8107492	18-7213	13524A6	18-5432
97401	18-7283	821630	18-6094A	8107493	18-7214	13524Q06	18-5432
99186	18-6273-1	821630	18-6240	8168111	18-3752	13524T1	18-5431
99186-1	18-6273-1	821663	18-6960	8168112	18-3752	14034A3	18-2420
110990	18-0980	822777	18-6014	8168771	18-7083	14034A5	18-2420
162533	18-36953	823033	18-5182	8168772	18-7083	14034F1	18-2420
195141	18-5315-1	823034	18-5793	8168773	18-7083	14034T	18-2420
256611	18-5836	823728	18-7749	8172761	18-3122	14034T10	18-2420
316403	18-6011	824519	18-2346	8172763	18-3122	14035A3	18-2421
316404	18-6011	826134	18-6068	8216631	18-6960	14035A5	18-2421
324351	18-3117	828151	18-5849	8227731	18-0202-9	14035F1	18-2421
393831	18-2128	828708	18-6773	8227772	18-6014	14035T	18-2421
428381	18-8305	834832	18-6844	8503991	18-3583	14035T10	18-2421
460201	18-2125	835076	18-7749	8503991	18-3599-1	14244T	18-0616
621041	18-2322	844727	18-3575	8504541	18-3577-1	14336A15	18-6747
681001	18-2342	846070	18-5817	8504541	18-3577-1	14336A15	18-6752
684311	18-7083	849896	18-7686	8504851	18-5408	14336A15	18-6813
758321	18-2104	849899	18-7683	8507521	18-2162	14336A17	18-6747
758321	18-2174	849934	18-7682	8507521	18-2162E	14336A17	18-6752
762142	18-6016	850055	18-3534	8507522	18-2162	14336A20	18-6274
774811	18-2150	850399	18-3599-1	8507522	18-2162E	14336A20	18-6746
802464	18-5107-1	850454	18-3574	16066004	18-25400	14336A20	18-6746
802630	18-7663	850454	18-3577-1	46020002	18-2125	14336A20	18-6813
802632	18-33104	850458	18-0614	88245191	18-2346	14336A22	18-6747
803148	18-7757	850484	18-5362	392889925	18-7493	14336A22	18-6752
803149	18-7697	850485	18-5408	802630001	18-7663	14336A25	18-6746
803470	18-7878-1	850487	18-5107-1	811637001	18-5107-1	14336A28	18-6747

Mercury Marine cont.		Mercury Marine cont.		Mercury Marine cont.		Mercury Marine cont.	
14336A28	18-6752	23014A1	18-7804	45518A1	18-2161	62351A1	18-5707
14336A31	18-6746	31640A1	18-6011	45518A2	18-2161	62351A2	18-5707
14336A6	18-6747	31640A1	18-6011A	45518A3	18-2161	63115A12	18-7633
14336A6	18-6752	31640A1	18-6241	45589A1	18-2169	63908A2	18-1910
14336A6	18-6813	31640A2	18-6011	45589A3	18-2169	65057A1	18-5802
14336A8	18-6746	31640A4	18-6011	45706A1	18-2142	65057T1	18-5802
14336A8	18-6769-1	31640Q4	18-6011A	45706A12	18-2142	65142A1	18-3575
14336A8	18-6813	31640Q4	18-6241	45706A14	18-2142	65142A1	18-3593
14336A9	18-6747	31640T6	18-6011	45706A3	18-2142	65603A12	18-1962-1
14336A9	18-6752	31640T6	18-6011A	45706A4	18-2148	65603A4	18-1962-1
14336A9	18-6753	31640T6	18-6241	45706A6	18-2142	65604A12	18-1958-1
14336A9	18-6813	32170A1	18-6013	45706A8	18-2142	65604A4	18-1958-1
14505A2	18-2172	32193A2	18-5433	46020T	18-2125	66065A1	18-2157
14586A3	18-43052	32489A2	18-3219	463999A2	18-6014	66065A1	18-2159
14698T	18-2373	32492A2	18-2171	46399A1	18-6014	66065A1	18-2190
14698T10	18-2373	32492A3	18-2171	46399A1	18-6014A	66065A1	18-2190E
15103A3	18-1137	32492A5	18-2171	47441A1	18-1977-1	66067T	18-2286
16061T	18-5792	32657A3	18-9099	47487T	18-5978	66069A2	18-2157
16064A1	18-5185	32657A4	18-9099	47587A2	18-1910	66069A2	18-2159
16457A4	18-5395	32734A3	18-2750	47587A2	18-1993	66069A2	18-2190
16610M	18-8070	32992A1	18-2189	47638A1	18-1995	66069A2	18-2190E
16755A1	18-2516	33662Q	18-5345	47886T	18-5808	66081A1	18-0577
16755A1	18-2615	33765T	18-5386	48752T	18-3114	66081A2	18-0577
16755Q1	18-2516	33981T	18-2162	49518A1	18-2248	66081A4	18-0577
16755Q1	18-2615	33981T1	18-2162	49964A1	18-1971	66599A1	18-7811
16755T1	18-2615	33981T1	18-2162E	49964A2	18-1971	66599A2	18-7812
16792A33	18-7508	34086A1	18-2189	52731A1	18-7824-1	66599A3	18-7813
16792A39	18-7508	34127A1	18-6012	52731A1	18-7876	67914A2	18-6763
17177A1	18-5313-1	34127A2	18-6012	53114A1	18-2759	68162A1	18-5798
17340T	18-1400	34127T1	18-6012	54293A13	18-5822	68162A3	18-5797
17649T	18-6772	34127T2	18-6012	54393A10	18-5822	68162A5	18-5798
17693A2	18-7633	34235Q1	18-5250	54393A4	18-5822	68162A6	18-5797
18309A2	18-2412	34235T	18-5311	55278A1	18-7807	68162A8	18-5798
18311A17	18-2412	34235T1	18-5250	55278A3	18-7809	68521A3	18-5313-1
18311A2	18-2412	34762A1	18-6013	55278A4	18-7809	68521A4	18-5313-1
18312A3	18-2382	34765A1	18-4456	55278A5	18-7808	68704A1	18-1148
18495A12	18-5790	34765A2	18-4456	55538A2	18-1973	69354A1	18-2413
18495A19	18-5790	35187A1	18-2248	55989A3	18-60151-9	69354A2	18-2413
18495A26	18-5790	35187A2	18-2248	55989A3	18-6015-9	70125A02	18-7665
18525A1	18-6771	35187A4	18-2248	55989A3	18-6015A-9	70125A1	18-7665
18643A2	18-21751	35993A1	18-0577	55989A3	18-6242-9	70981A3	18-2762
18643A5	18-2323	36223A1	18-2752	55989A4	18-60151-9	71464A01	18-7667
18643A7	18-2175	36223A2	18-2752	55989A9	18-60151-9	71683A1	18-3584
18643A7	18-21751	37611A1	18-2189	55989Q9	18-60151-9	72436A1	18-6011
18654A1	18-2750	38399A2	18-2189	55989Q9	18-6015-9	73020A1	18-2191
19052A3	18-5791	38965A1	18-2171	55989Q9	18-6015A-9	73020A14	18-2191
19052A5	18-5791	38965A2	18-2171	55989Q9	18-6242-9	73020A20	18-2376
19052A8	18-5791	39383T	18-2128	55989T9	18-60151-9	73345A1	18-4233
19217A1	18-6777	39920A1	18-1973	55989T9	18-6015-9	73679A2	18-2157
19217A5	18-6777	41141A2	18-7284	55989T9	18-6015A-9	73679A2	18-2159
19291A3	18-2370	41155A1	18-9099	55989T9	18-6242-9	73679A2	18-2190
19297A3	18-2145	41155A2	18-9099	56211A1	18-2191	73679A2	18-2190E
19405A4	18-5432	41639A1	18-7230	57882T	18-7232	73723A01	18-2248
19543A10	18-2157	41951A1	18-2157	58217Q	18-5418	73723A1	18-2248
19543A10	18-2159	41951A1	18-2159	58397A2	18-6749	73813A1	18-1990
19543A10	18-2190	41951A1	18-2190	58397A3	18-6749	73813F1	18-1990
19543A10	18-2190E	41951A1	18-2190E	58759A10	18-1960-1	73873A1	18-8227
19543A2	18-2157	42419A1	18-6749	58759A14	18-1960-1	74313A4	18-1131
19543A2	18-2159	42419A1	18-6749	59078A1	18-3550	74436A9	18-6768
19543A2	18-2190	42419A1	18-6750	59137A1	18-3551	74436A9	18-6799
19543A2	18-2190E	42431M	18-3426	59341A1	18-1213	74639A2	18-2753-2
19543A2	18-2190E	42724A3	18-3219	59341A1	18-56870	74905A3	18-5313-1
19543A4	18-2157	42725A3	18-35437	59826A1	18-2173	75282A1	18-4221
19543A4	18-2159	42725A3	18-7282	59826A3	18-2173	75832A1	18-2104
19543A4	18-2190	42909A1	18-7818-1	59829A1	18-9218	75832A1	18-2174
19543A8	18-2157	42909A2	18-7818-1	59830A1	18-2146	75832A2	18-2104
19543A8	18-2159	42909A3	18-7818-1	59830A5	18-9218	75832A2	18-2174
19543A8	18-2190	42909A4	18-7818-1	59830A7	18-2146	75832A3	18-2104
19543A8	18-2190E	43396A2	18-6249	60252A2	18-4009	75832A3	18-2174
19543T1	18-2603	43396A2	18-6249A	60372A1	18-1910	75832T	18-2104
19543T1	18-2603E	43432A2	18-2145	60372A1	18-1993	75832T	18-2174
19543T2	18-2603	43557A1	18-5395	60372A2	18-1910	75832T1	18-2104
19543T2	18-2603E	43567A1	18-1567	60372A2	18-1993	75832T1	18-2174
19755A08	18-2196	43567T1	18-1567	60426A1	18-1971	75962A10	18-43052
19755A2	18-2286	43994A2	18-6066	60908A2	18-1993	75962A11	18-43052
19755A4	18-2196	43994A2	18-6066A	60932A1	18-2751	75962A9	18-43052
22831A1	18-8069	43994A2	18-6243	60932A4	18-2751	762142A1	18-6016
22831A3	18-8069	44354A10	18-1976-2	62092T	18-7267	76214A5	18-6016
22831A4	18-8069	44354A13	18-1976-2	6231A4	18-5872	76214Q5	18-60161
22831B3	18-8069	44354A3	18-1976-2	6231A5	18-5872	76214Q5	18-6016A
22831Q3	18-8069	44354A9	18-1976-2	6231A6	18-5872	76214Q5	18-6244

*Para localizar el número de página, consulte el índice / referencia de la página 750 a 781

Mercury Marine cont.		Mercury Marine cont.		Mercury Marine cont.		Mercury Marine cont.	
76214T3	18-60161	806105Q1	18-6079	814481M	18-7769	822777A3	18-6014
76214T3	18-6016A	806105Q1	18-6093	814819A2	18-9218	822777A4	18-6014
76214T3	18-6244	806105Q1	18-6093A	815113T02	18-5185	822777Q1	18-6014
76270T	18-3552	806105T1	18-6079	815279A2	18-5741	822777Q1	18-6014A
76314A3	18-5866	806105T1	18-6093	815407A2	18-5396	822870A1	18-6777
76325A2	18-1972	806105T1	18-6093A	815425T	18-5899	823034T	18-5793
76351A04	18-1971	806189A1	18-6067	815471A3	18-2145	823426A1	18-7072
76351A1	18-1971	806189A1	18-6067A	815471A3	18-2145E	823426A1	18-7077
76351A2	18-1971	806189A1	18-6114	815471A6	18-2145	823427A1	18-7746
76771A2	18-1978	806189Q1	18-6114	815471A6	18-2145E	823653A5	18-6765
76771A3	18-1978	806189T1	18-6114	815471T1	18-2604	823653A9	18-6765
76850A2	18-2171	806190A1	18-6089	815471T1	18-2604E	825096T01	18-5821
77123A1	18-1705	806190A1	18-6092	815919A1	18-2320	825467A1	18-7901
77234A2	18-1950-1	806190A1	18-6092A	815921A2	18-2353	825467T1	18-7901
77234A7	18-1950-1	806190Q1	18-6092	815922A1	18-2354	826134A1	18-6068
77235A2	18-1951-1	806190Q1	18-6092A	815922A5	18-2354	826763A	18-3154
77235A8	18-1951-1	806190T1	18-6089	815933A1	18-6080	828151A1	18-5849
77442A1	18-2148	806190T1	18-6092	815933A1	18-6099	828692A1	18-2382
78403A1	18-5956	806190T1	18-6092A	815935A3	18-2422	828708A1	18-6774
78403A1	18-5957	806191T	18-2373	815935A7	18-2422	830250A3	18-6777
78403A1	18-6841	806490T	18-5897	815954A3	18-2423	830250T3	18-6777
78403A1	18-6842	806612T	18-7677	815954A7	18-2423	832021A1	18-6777
78403A2	18-5956	806673T	18-5442	816148A1	18-5313-1	832021A2	18-6777
78403A2	18-5957	806673T1	18-5442	816329A3	18-1966	832021T2	18-6777
78403A2	18-6841	806807A1	18-7691	816431A1	18-2747	832021T4	18-6777
78403A2	18-6842	806808A2	18-33201	816610A1	18-2244	833232E	18-4173
78458A1	18-2760	806867A 8	18-1956-1	816610A2	18-2244	834832T2	18-6844
786214A2	18-6016	806867A 8	18-1956-2	816770T	18-5707	84141M	18-7840
78687T	18-2144	806867A12	18-1966	817019A1	18-9099	84188M	18-3425
79271A4	18-6763	806867A2	18-1966	817019A2	18-9099	84188T	18-3425
79271A4	18-6768	806867A3	18-1966	817019Q2	18-9099	84262M	18-7837
79271A4	18-6799	806867A8	18-1966	817119A1	18-5957	84265M	18-7838
802128A1	18-7831	806867A9	18-1966	817119A1	18-5965	84419M	18-7290
802371A1	18-5181	807057T	18-5851	817119A1	18-5966	84456M	18-7770
802630T	18-7663	807074A1	18-3531	817119A4	18-5957	84475M	18-7291
802630T01	18-7663	807078A 6	18-1957-1	817119A4	18-5965	845668T	18-0614
802632T	18-33104	807166A3	18-2732	817119A4	18-5966	84829M	18-3426
802706A1	18-7738	807252Q3	18-3646	817275A08	18-3406	850454 1	18-3574
803061T1	18-3569	807252Q4	18-3668	817275A09	18-3407	850484T	18-5362
803470Q	18-7878-1	807252Q5	18-3647	817275A1	18-3571	850484T2	18-5362
803844T01	18-25513	807252T1	18-3551	817275A2	18-3572	850484T3	18-5278
804346T1	18-7743	807252T2	18-3649	817275K05	18-3147	85147A5	18-2145
804483T	18-5354	807252T4	18-3668	817275T4	18-3147	852956A1	18-7685
805016A1	18-7228	807252T6	18-3646	817373A1	18-6094	852956A1	18-7690
805016A1	18-7234	807252T8	18-3647	817377T	18-5475	853678T	18-7700
805025A2	18-7326	807476A6	18-1908K	817378T	18-5443	853998A1	18-7690
805025A2	18-8867	807652T	18-5967	818298A1	18-6249	853998T	18-7690
805101T	18-3787	807653T	18-5960	818298A1	18-6249A	854472A2	18-6777
805185A36	18-5471	807757T	18-6457	818298Q1	18-6249	854472A3	18-6777
805185A37	18-5470	807914A1	18-1976-2	818298Q1	18-6249A	854472A4	18-6777
805217A1	18-7684	807929A1	18-2354	818763A10	18-2376	855654A1	18-6777
805218T	18-7600	807929A2	18-2354	818763A4	18-2376	855654T2	18-6777
805222A1	18-5484-1	807964A1	18-5476	818903A1	18-6777	857006A3	18-6844
805223T	18-7702	807988A03	18-1976-2	819479A1	18-6777	85784A1	18-7228
805224A1	18-7632	807988A2	18-1976-2	819480A1	18-6777	85785A2	18-7231
805226A1	18-7630	808015T	18-7553	821509T1	18-5852	85785T	18-7229
805227A1	18-7652	808064A1	18-3531	821629A1	18-6080	859168T	18-6829
805298A1	18-31102	808349A1	18-2286	821629A1	18-6080A	860235A03	18-1966
805320A03	18-7633	808349T1	18-2286	821629A1	18-6099	860235A04	18-1956-2
805320A1	18-7633	808483K2	18-5291	821629Q1	18-6080A	860246A10	18-1953-2
805536A1	18-2097	808483Q2	18-5281	821630A1	18-6094	860246A3	18-1953-2
805536A2	18-2097	808483T3	18-5354	821630A1	18-6094A	860246A7	18-1953-2
805544T	18-7703	808484 1	18-5405	821630A1	18-6240	860246A9	18-1953-2
805656A2	18-7326	809449A1	18-7216	821630C2	18-6094	860256A2	18-3530-1
805656A2	18-8867	809463A1	18-5811	821630Q1	18-6094A	860256A4	18-3530-1
805656A5	18-7326	811536T	18-36906	821630Q1	18-6240	860336A2	18-1953-2
805656A5	18-8867	811618A1	18-6751	821630T1	18-6094A	860337A2	18-1953-2
805656A6	18-7326	811635Q2	18-5280	821630T1	18-6240	860349A1	18-33207
805656A6	18-8867	811635T3	18-5361	821631A1	18-6066	861006A1	18-1989
805759A1	18-5395	811636 1	18-5406	821631B1	18-6066	861155A2	18-8868
805759A2	18-5395	811637T	18-5107-1	821631C	18-6066	861155A3	18-8868
805759A5	18-5395	811639T	18-5108	821631Q1	18-6066	861155A5	18-7326
805759Q3	18-5273	811673 1	18-6775	821631Q1	18-6066A	861155A5	18-8867
805759T	18-5395	81242M	18-3427	821631Q1	18-6243	861155A6	18-7326
805759T1	18-5395	812454A1	18-7288-1	821663A1	18-6960	861155A6	18-8867
805759T3	18-5273	812454A3	18-7288-1	821759A1	18-2354	861156A02	18-8861
805884T	18-5965	812843A1	18-6751	821759A2	18-2354	861156A03	18-8862
80606M	18-7839	812964A2	18-2412	821759A3	18-2354	861156A04	18-8863
806105A1	18-6079	813442A1	18-6751	821759A4	18-2354	861156A1	18-35433
806105A1	18-6093	813442A2	18-6751	822777A1	18-6014	861188A1	18-3531
806105A1	18-6093A	814309A1	18-2434	822777A1	18-6014A	861249A1	18-7550

Mercury Marine cont.		Mercury Marine cont.		Mercury Marine cont.		Mercury Marine cont.	
86125A1	18-7639	87114A30	18-1953-2	898253T23	18-5243	97401A2	18-7283
861260T	18-7692	87399A1	18-2428	898253T24	18-5433	97401A8	18-7283
861493A07	18-1910	87399A2	18-2428	898253T27	18-5443	97432A2	18-2414
861493A07	18-1993	87399A3	18-2429	898253T28	18-5246	97793M	18-3426
861493A3	18-1910	875285T1	18-6454	898253T29	18-5247	97793T	18-3426
861493A3	18-1993	875286A1	18-6455	89876A3	18-7853-1	98230A1	18-73131
861523A9	18-2412	875286T	18-6455	899106T01	18-8866	98502A2	18-1974-1
861676A1	18-35437	87581T	18-5315-1	8M0027721	18-2560	98503A2	18-1970-1
861676T09	18-35437	878265A4	18-6773	8M0045604	18-2700	98504A3	18-1970-1
861676T09	18-7282	878265A6	18-6774	8M0054726	18-7660	98555A1	18-5957
861677T	18-8860	881150K1	18-9895	8M0058164	18-7283	98555A1	18-5965
861678A1	18-7283	881247A1	18-6455	8M0058677	18-6157A	98555A1	18-5966
86177 1	18-5658	881248T02	18-6454	8M0060495	18-5247	98562A6	18-1937
862030T	18-5983	88183A11	18-6752	8M0061335	18-5247	98703A11	18-2424
862031T	18-6293	88183A12	18-6747	8M0061381	18-1989	98703A12	18-2424
862031T1	18-6293	88183A12	18-6752	8M0061381	18-1994	98703A17	18-2424
862048A1	18-7288-1	88183A12	18-6753	8M0062084	18-5408	98703A26	18-2424
862077A1	18-7284	88183A12	18-6813	8M0062406	18-2756	98703A3	18-2426
862129A1	18-1709	88183A3	18-6747	8M0068784	18-5899	98704A11	18-2425
862132T	18-1711	88183A5	18-6746	8M0069803	18-7663	98704A12	18-2425
86234A05	18-7278	88183A5	18-6769-1	8M0073435	18-35437	98704A17	18-2425
86234A3	18-7278	88183A5	18-6813	8M0074922	18-43017	98704A26	18-2425
86234A4	18-7278	88183A6	18-6752	8M0084523	18-6948	98704A3	18-2427
86246A1	18-7274	88183A8	18-6813	8M0084600	18-5224	99155A1	18-3555
86246T	18-7274	882751A04	18-5850	8M0089715	18-3551	99155T1	18-3568
86247A2	18-7275	882751A1	18-5849	8M0091470	18-3649	99155T2	18-3555
86247T	18-7275	882751A2	18-5849	8M0098795	18-2412	99186T	18-6273-1
862548A1	18-6749	883072T	18-5743	8M0104229	18-3016-1	99297A1	18-2193
862548A1	18-6750	883166A1	18-6778	8M0110717	18-2373	99297A2	18-2193
863077T	18-6298	883166A2	18-6778	8M0708280	18-2425	993247A4	18-6768
863358T	18-43017	88475A4	18-6768	8M2009865	18-2130	99356A2	18-2587
863416T	18-31103	88475A4	18-6799	8M6001217	18-5338	99370A2	18-2733
864281A01	18-6405	884794A02	18-5351	8M6001218	18-5345	99660A1	18-6751
864281A2	18-6402	884794A1	18-5351	8M6001219	18-5303	99746A17	18-1952-1
864281A7	18-6402	88553A1	18-6749	8M6001224	18-5404-1	99746A8	18-1952-1
864282T	18-6403	88678A4	18-7633	8M6001249	18-5347	99798A16	18-1956-2
864308T01	18-1843	88678A5	18-7633	8M6001250	18-5314	99798A18	18-1956-1
864591T02	18-1845	888751A02	18-5350	90363A1	18-7810	99798A18	18-1956-2
86459A1	18-9099	888751A03	18-5350	90576A4	18-5432	99798A18	18-1966
86459A2	18-9099	888751A1	18-5350	90746A1	18-5395	99798A3	18-1956-2
864856A1	18-7684	888755A1	18-6158M	90796A4A1	18-5476	99798A9	18-1956-2
865049T01	18-1843	888755Q01	18-6158M	90806A1	18-5899	F10077105	18-2917
865202T	18-5851	888756A2	18-6150A	91748M	18-7834	F1348	18-3713
865380A02	18-6747	888756A2	18-6150M	91823A3	18-5313-1	F1881	18-3713
865380A02	18-6752	888756A2	18-6150Z	92459A4	18-6765	F2769931	18-1402
865380A03	18-6746	888756Q01	18-6158A	92497A3	18-5957	F2774666	18-3575
865380A05	18-6747	888756Q02	18-6150A	92497A3	18-5965	F2774666	18-3593
865380A05	18-6752	888756Q02	18-6150M	92520M	18-7293	F328506	18-3937
865380A13	18-6746	888756Q02	18-6150Z	92975A28	18-6763	F328516	18-3938
865380A13	18-6813	888756Q4	18-6150A	92975A32	18-6763	F347013	18-1315
865380A15	18-6747	888756Q4	18-6150M	92975A6	18-6763	F3746241	18-4492
865380A15	18-6752	888756Q4	18-6150Z	93247A4	18-6799	F3750884	18-1339
865380A25	18-6747	888757Q01	18-6159M	93247A7	18-6768	F3829064	18-1316
865380A25	18-6752	888758A1	18-6159A	93247A7	18-6799	F3860315	18-25001
865380A25	18-6813	888758Q01	18-6159A	93320A13	18-1908K	F3866612	18-4022
865425A03	18-1709	888759A1	18-6159M	93320A2	18-1908K	F3892364	18-3937
865436A02	18-2157	888760A1	18-6160M	93320A3	18-1908K	F3910555	18-1308
865436A02	18-2159	888760Q01	18-6160M	93320A5	18-1908K	F3916351	18-1308
865436A02	18-2190	888761A1	18-6160A	93320A6	18-1908K	F3932344	18-0874
865436A02	18-2190E	888761Q01	18-6160A	93477T	18-0615	F40109	18-2244
865436A03	18-2603	888909A1	18-0557	94998A1	18-2381	F50556	18-2945
865436A03	18-2603E	88893A4	18-6749	94998A2	18-2381	F508814	18-1129
865437A02	18-2145	889955T01	18-6454	94998A3	18-2381	F5232670	18-1402
865491A01	18-6405	89011A8	18-1957-1	94998A4	18-2381	F6269358	18-3577-1
865492T	18-6403	89031A1	18-7811	95661M	18-3427	F694961	18-2346
865493A01	18-6406	89031A2	18-7812	95755A2	18-1970-1	F694961-1	18-2346
865496A01	18-6406	89031A3	18-7813	95862A5	18-1954-1	F700633	18-4263
865496A01	18-6406	89031A4	18-7814	95864A2	18-1975-1	F7040	18-3700
865503T	18-6404	891736T	18-6772	96184A1	18-1567	F720301	18-5881
865510T	18-6406	892864T04	18-3631	96455A1	18-5797	F724073	18-1300
865511T	18-6406	892874T01	18-8866	96455A11	18-5795	F724102	18-1401
865735A02	18-1843	892940T	18-5929	96455A15	18-5796	F749301	18-5775
866169A01	18-8864	893640T01	18-5732	96455A6	18-5798	F7778A9	18-5775
866169T01	18-8864	893929A01	18-6751	96455A8	18-5797	F8077	18-2945
866170A01	18-8865	89396A38	18-8004EP-1	96455A9	18-5798	F8186	18-2945
86617A17	18-5863	89396A38	18-8004S	96477A3	18-6752	F84903	18-1162
86617A20	18-5864	89396Q38	18-8004EP-1	96705A1	18-1955-1	F84901	18-1162
86840A05	18-2756	89396Q38	18-8004S	96863A15	18-7633	FFF001138	18-7964
86840A3	18-2756	896173A01	18-2700	97257A1	18-5897	FI000034	18-1190
87114A19	18-1953-2	897755T	18-6840	97258A1	18-5898	FI1001079	18-3593
87114A19	18-1953-2	898253T22	18-5244	97399A2	18-7288-1	FI1100014	18-4492

*Para localizar el número de página, consulte el índice / referencia de la página 750 a 781

OMC cont.		OMC cont.		OMC cont.		OMC cont.	
308458	18-7461	314502	18-3742	319891	18-3707	323312	18-0445
308500	18-8351	314503	18-3705	319895	18-2287	323361	18-2230
308621	18-7121	314728	18-7130	320041	18-2379	323362	18-2229
308624	18-7103	314730	18-3719	320140	18-7178	323459	18-0999-9
308626	18-7198	314731	18-0195	320166	18-2224	323469	18-0102
308627	18-7104	314745	18-2231	320167	18-2225	323582	18-8372
308799	18-2863	314809	18-2858	320168	18-2226	323626	18-3136
308825	18-0653	314832	18-2389	320169	18-2227	323653	18-6522
308876	18-7123	314876	18-2874	320170	18-2228	323664	18-2220
308928	18-3108	315052	18-0973	320303	18-7140	323889	18-2232
309044	18-2534	315055	18-0937	320305	18-4230	323890	18-2233
309243	18-1236	315189	18-0939	320311	18-2398	323943	18-4232
309612	18-2950	315232	18-7296	320499	18-1377	324073	22423
309731	18-7156	315288	18-0542	320533	18-2963	324097	18-3179
309955	18-3741	315538	18-0941	320570	18-4231	324323	18-0106
309956	18-2898	315539	18-2958	320630	18-2220	324324	18-3803
309989	18-2000	315578	18-0424	320658	18-3802	324334	18-4276
310058	18-0182	315748	18-2705	320745	18-2964	324369	18-2399
310137	18-2868	315810	18-4228	320785	18-3743	324430	18-4277
310327	18-7173	315837	18-3337	320862	18-2002	324449	18-0108
310414	18-7167	315868	18-1218	320880	18-1219	324639	18-2034
310584	18-7135	315869	18-1224	320936	18-0540	324670	18-0110
310585	18-7158	316499	18-0949	320943	18-2704	324701	18-2557
310599	18-2012	316506	18-2243	320961	18-8353	324717	18-0112
310649	18-2020	316563	18-2377	320981	18-3343	324766	18-0198
310913	18-2947	316705	18-4913	321008	18-2706	324825	18-8204
310953	18-15460	316706	18-4914	321027	18-3563	324937	18-2537
310967	18-7158	317178	18-7109	321028	18-2544	324981	18-7481
311046	18-15440	317201	1525607	321117	18-7141	325092	18-0118
311068	18-2896	317232	18-2234	321120	18-2536	325211	18-0120
311068	18-2896-1	317245	18-1243	321163	18-7510	325260	18-0122
311069	18-0164	317305	18-0951	321182	18-2545	325273	18-3800
311121	18-2861	317624	18-1279	321183	18-0979	325398	18-3352
311121	18-2861-1	317831	18-4290	321184	18-2546	325537	18-0124
311130	18-2860	317838	18-2219	321220	18-3565	325647	18-3801
311131	18-2859	317841	18-3182	321221	18-3567	325721	18-2907
311145	18-0679	317914	18-2866	321222	18-3562	326260	18-2862
311210	18-3880	317951	18-0953	321435	18-2549	326264	18-0126
311338	18-7105	317955	18-0117	321453	18-2026	326468	18-0128
311364	18-1228	318156	18-0955	321459	18-2027	326649	18-7174
311508	18-0917	318303	18-2209	321466	18-2059	326716	18-0174
311598	18-4248	318304	18-2208	321467	18-2060	326741	18-7418
311598	18-42481-9	318334	18-2872	321479	18-0981	326765	18-4292
311606	18-15400	318335	18-2873	321481	18-2029	326849	18-7144
311684	18-7854	318358	18-2956	321497	18-0983	326877	18-6509
312456	18-7860	318372	18-7137	321504	18-8351	326926	18-1212
312634	18-2879	318373	18-0957	321573	18-2862	326953	18-2888
312679	18-2900	318395	18-3564	321648	18-5655	327031	18-2035
312780	18-0874	318544	18-2378	321692	18-2391	327035	18-2392
312781	18-71337	318544	18-23781-9	321722	18-0985	327361	22423
312797	18-2917	318544	18-4249	321724	18-70936	327606	18-6018
312800	18-0876	318609	18-2543	321727	18-2864	327655	18-1289
312932	18-6511	318717	18-7138	321786	18-2030	327656	18-0200
313065	18-2901	318841	18-4222	321787	18-2031	327674	18-3899
313080	18-2767	318914	18-2963	321788	18-2032	327707	18-0134
313175	18-7107	318917	18-0397	321794	18-0989	327795	18-3802
313176	18-3141	318924	18-0959	321830	18-8304	327861	18-4280
313244	18-0923	318925	18-2853	321831	18-0542	328283	18-0136
313282	18-2023	318932	18-0961	321886	18-3290	328313	18-1288
313283	18-0173	318940	18-1505	321895	18-0543	328360	18-9885
313284	18-2005	318944	18-6503	321907	18-0991	328361	18-9886
313340	18-7126	318971	18-3706	321921	18-7411	328363	18-9887
313353	18-2058	318972	18-2025	321928	18-2033	328364	18-9888
313368	18-2851	318973	18-2028	321932	18-0675	328365	18-9889
313413	18-2960	318995	18-3178	321940	18-3126	328366	18-9890
313416	18-0929	319085	18-7139	322119	18-7133	328367	18-9891
313446	18-7127	319097	18-2913	322119	18-7142	328506	18-3937
313448	18-1714	319126	18-3369	322236	18-4911	328516	18-3938
313507	18-0543	319174	18-2867	322332	18-2962	328536	18-3940
313754	18-7128	319275	18-3127	322411	18-0892	328590	18-0138
313763	18-2865	319332	18-0967	322501	18-7143	328603	18-8350
313782	18-2884	319348	18-2904	322652	18-8020	328604	18-0140
313893	18-7108	319586	18-0969	322653	18-8200	328622	18-0142
313992	18-2016	319633	18-2954	322654	18-8202	328623	18-3837
314008	18-2703	319661	18-0971	322656	18-8051	328626	18-0144
314082	18-2855	319662	18-7457	322858	18-2547	328751	18-3358
314115	18-0933	319664	18-2093	322941	18-3763	328753	18-2539
314167	18-2024	319665	18-2856	323214	18-2550	328755	18-3359
314322	18-0935	319710	18-2878	323217	18-0945	329076	18-0441
314421	18-2877	319771	18-2857	323222	18-0995	329103	18-2961
314491	18-7129	319890	18-4229	323311	18-0446	329380	18-7416

*Para localizar el número de página, consulte el índice / referencia de la página 750 a 781

OMC cont.		OMC cont.		OMC cont.		OMC cont.	
329381	18-7417	334665	18-4197	349759	18-9138-9	384163	18-5630
329390	18-3360	334726	18-3839	349957	18-9876	384163	18-5630
329419	18-3803	334742	18-1734	351271	18-1281	384194	18-7605-1
329653	18-8203	334897	18-3138	352165	18-0313	384195	18-1357
329654	18-8034	334913	18-7150	352670	18-0465	384719	18-3560
329718	18-0148	334950	18-8367	353076	18-2075	384735	18-5418
329826	18-0851	335334	18-7796	357159	18-0153	384743	18-7072
329828	18-1205	335359	18-3802	357159	18-0411	384777	18-5648
329830	18-1202	335360	18-2964	370409	18-3944	384781	18-5671
329833	18-1207	335361	18-3801	375638	18-3002	384848	38653
329836	18-3836	335403	18-1285	377139	18-1154	384884	37509
329920	18-2905	335523	18-7110	377178	18-3003	384956	18-3376
329922	18-2061	335523	18-0490	377230	18-3083	385043	18-1371
329923	18-2062	335633	18-0963	378065	18-3543	385068	18-1367
330081	18-4076	335677	18-9219	378231	18-5437	385072	18-3044
330137	18-2001	335679	18-2279	378444	18-5807	385356	18-7024
330273	18-1221	335722	18-2277	378891	18-3006	385391	18-5753
330327	18-2063	335818	18-1283	378895	18-7093	385416	18-4300
330412	18-0155	335819	18-1284	379312	18-7038	385503	18-1395
330525	18-6512	335981	18-1507	379313	18-7094	385529	18-5634
330560	18-3363	336226	18-0694	379475	18-3086	385662	18-3906
330619	18-3295	336227	18-0693	379504	18-1350	385781	18-7352
330621	18-2852	336232	18-1286	379628	18-2192	385952	18-5697
330698	18-0157	336388	18-0696	379763	18-3201	386014	18-1296
330818	18-2963	336389	18-0695	379766	18-3203	386084	18-3050
330854	18-1391	336430	18-0945	379777	18-7801	386124	18-3384
330909	18-0159	336530	18-2709	379957	18-4218	386279	18-3931
331103	18-8307	336562	18-2216	380186	18-7071	386280	18-3933
331107	18-3299	336982	18-42531-9	380537	18-5345	386430	18-6434
331188	18-7143	336982	18-4253-9	380538	18-5311	386533	18-3388
331203	18-2890	337020	18-1290	380541	18-5385	386545	MP39100
331211	18-3838	337068	18-0412	380542	18-5419	386545	MP39830
331353	18-7963	337772	18-2216	380543	18-5310	386573	18-2857
331363	18-2879	337774	18-2216	380640	18-3575	386591	18-5629
331380	18-7150	337778	18-1500	380986	18-7258	386657	18-5648
331499	18-2908	338484	18-2557	381389	18-7200	386659	18-2355
331532	18-0161	338504	18-1732	381494	18-7609-1	386697	18-3327
331598	18-0978	338518	18-7108	381538	18-3059	386764	18-1354
331880	18-3765	338534	18-6522	381668	18-7608-1	386765	18-1355
331894	18-3566	338813	18-2582	381690	18-7860	387041	18-1353
331916	18-2913	338876	18-2879	382045	18-7043	387094	18-5640
331917	18-2938	338878	18-2908	382046	18-7043	387139	18-4040
331979	18-3133	338879	18-2900	382047	18-7043	387142	18-4040
331980	18-1704	338880	18-2903	382049	18-7043	387247	18-1158
331999	18-4826	338882	18-2579	382050	18-7010	387262	18-7038
332000	18-2769	338884	18-2906	382051	18-7010	387277	18-6761
332010	18-2888	338886	18-2890	382052	18-7024	387284	18-4124
332108	18-2548	339601	18-0692	382053	18-7024	387285	18-4114
332205	18-2064	339620	18-2074	382054	18-7010	387326	18-3325
332253	18-8352	340115	18-3866	382057	18-7026	387361	18-3090
332261	18-2065	340490	18-2219	382125	18-5344	387610	18-3327
332266	18-0130	340619	18-3455	382133	18-5375	387656	18-1365
332319	18-0987	340919	18-0492	382135	18-5314	387660	18-4061
332369	18-0977	340975	18-70936	382136	18-5338	387661	18-4062
332403	18-2881	340976	18-70937	382138	18-6754	387683	18-5674
332489	18-2309	341013	18-1598	382218	18-3583	387684	18-5630
332491	18-2308	341280	18-8300	382218	18-3599-1	387684	18-5630
332584	18-7475	341281	18-8301	382221	18-45221	387787	18-1361
332585	18-0559	341440	18-9892	382296	18-3402	387817	18-1117
332598	18-7120	341501	18-0628	382343	18-1356	387818	18-2252
332694	18-2900	342786	18-8325	382354	18-7352	387879	18-2250
332696	18-2903	342787	18-8326	382363	18-7210	388268	18-7352
332816	18-3895	343863	18-1207	382385	18-3557	388344	18-1378
332817	18-3896	344470	18-3295	382407	18-1351	388517	37478
332819	18-3898	346004	18-1723	382408	18-1366	388602	18-4301
333008	18-0975	346007	18-0491	382468	18-3377	388644	18-3393
333077	18-2219	346150	18-9140-9	382547	18-3082	388644	18-3403
333096	18-2093	346151	18-9135-9	382715	18-6822	388891	18-3238
333418	18-2906	346152	18-9136-9	382733	18-7609-1	389039	18-1358
333572	18-7145	346153	18-9137-9	382821	18-7605-1	389042	18-1370
333592	18-4223	346785	18-9132-9	383052	18-7043	389112	18-3327
333670	18-3839	346786	18-9133-9	383067	18-7043	389143	18-3388
333725	18-0197	346930	18-9126-9	383087	18-7201	389206	18-4307
333758	18-2708	346931	18-9131-9	383307	18-3554	389275	18-5630
333771	18-0201	347107	18-9129-9	383440	18-5711	389275	18-5630
333879	18-0965	347108	18-9130-9	383444	18-5437	389289	18-3059
333957	18-1343	347205	18-0690	383587	18-5384	389455	18-3767
334043	18-0626	348838	18-9127-9	383615	18-7070	389556	18-4303-1
334163	18-3766	348839	18-9134-9	383766	18-7605-1	389576	18-3091
334353	18-0437	349516	18-9128-9	383918	18-7095	389589	18-3055
334516	18-2216	349729	18-9139-9	384087	18-3336	389642	18-3043

OMC cont.		OMC cont.		OMC cont.		OMC cont.	
389954	18-5634	395209	18-2187	432072	18-4065	436235	18-2330
390055	18-7046	395270	18-3383	432073	18-4066	436242	18-4055
390076	18-4318	395271	18-3401	432077	18-4067	436254	18-3901
390078	18-4302	395289	18-3051	432078	18-4068	436353	18-4088
390082	18-3972	395419	18-5808	432230	MP28880	436354	18-4090
390286	18-3366	395460	18-6501	432230	MP28900	436367	18-5886
390381	18-3379	395627	18-1374	432264	18-1369	436740	18-2251
390509	18-3907	395713	18-7352	432451	18-7352	436745	18-6024
390510	18-3908	395861	18-1753	432570	18-4322	436745	18-6024A
390641	18-1396	395864	18-3059	432803	18-4069	436746	18-2218
390770	18-3380	395867	18-7821	432925	18-5612	436834	18-1725
390905	22355	395911	18-6527	432941	18-3104	436859	18-4079
390928	79040	396041	18-1360	432941	18-3104-1	436860	18-4190
391170	18-3913	396141	18-5765	432955	18-3129	436888	18-2252
391264	18-6759	396161	18-6528	432956	18-3387	436891	18-4323
391300	18-4303-1	396235	18-5619	432962	18-7822	436954	18-3129
391305	18-7223	396349	18-2660	432969	18-4065	436957	18-3389
391416	18-3915	396350	18-2656	432970	18-4066	437059	18-3104
391472	18-2187	396351	18-2658	433003	18-4067	437059	18-3104-1
391511	18-5619	396352	18-2657	433004	18-4068	437090	18-3545
391635	18-3378	396355	18-2659	433017	18-2251	437155	18-4406
391638	18-7350	396377	18-3910	433067	18-1721	437228	18-0993
391653	18-4101	396378	18-3911	433190	18-79781	437327	18-7248
391698	18-3327	396379	18-3912	433226	18-6285	437409	18-4063
391698	18-3400	396503	18-3906	433386	18-7353	437725	18-4428
391735	18-5648	396504	18-3905	433387	18-7352	437779	18-4402
391937	18-7223	396520	18-7038	433458	18-6025	437801	18-6280
391988	18-4304-1	396521	18-7093	433503	18-1299	438039	18-1702
392061	18-7042	396522	18-7094	433519	18-7800	438040	18-1703
392061	18-7222	396583	18-4104	433548	18-3394	438399	18-1722
392123	18-6027	396585	18-4100	433550	18-2694	438529	18-6780
392133	18-5629	396587	18-4103	433570	18-2289	438531	18-6780
392455	18-4123	396588	18-4100	433580	18-6115	438555	18-7353
392462	18-6026	396701	18-7042	433935	18-3015	438556	18-7352
392475	18-1287	396701	18-7222	433941	18-4307	438562	18-7351
392550	18-7046	396725	18-3053-1	434063	18-2218	438591	18-3129
392567	18-4307	396750	18-4310	434107	18-3913	438592	18-3454
392615	18-4307	396809	18-3368	434109	18-3915	438616	18-7800
392621	18-4107	396852	18-3015	434137	18-3500	438786	18-6281
393023	18-6024	396932	18-3385	434381	18-4309	438996	18-7221
393023	18-6024A	396933	18-3399	434400	18-1703	438996	18-7247
393061	18-0466	396987	18-3557	434421	18-3392	439015	18-4195
393088	18-7823	397003	18-6525	434424	18-3001	439071	18-7043
393103	18-7820	397004	18-6526	434496	18-6780	439072	18-7223
393159	18-0153	397023	18-5619	434588	18-1729	439073	18-7219
393271	18-4120	397087	18-4818	434839	18-7916	439076	18-7046
393279	18-9894	397128	18-2289	434841	18-3543	439077	18-3378
393301	MP39760	397131	18-3059	434844	18-1376	439078	18-7248
393433	18-4305	397274	18-7350	434888	18-7046	439079	18-7248
393509	18-3381	397338	18-2207	435022	18-2251	439138	18-2288
393561	18-0927	397537	18-1363	435027	18-3346	439141	18-2623
393566	18-4122	397538	18-1364	435096	18-1703	439202	18-4420
393570	18-5628	397541	18-2288	435276	18-4841	439476	18-4807
393612	18-4102	397627	18-2310	435277	18-4840	439515	18-4165
393630	18-3382	397768	18-6029	435279	18-4843	439516	18-4086
393632	18-3367	397839	18-7350	435280	18-4842	439517	18-4087
393659	18-3543	398042	18-3708-1	435390	18-3180	439538	18-3947
393896	18-1393	398047	18-4321	435442	18-7221	439561	18-5828
393924	18-4120	398051	18-2093	435442	18-7247	439937	18-6281
393942	18-2585	398319	18-7831	435443	18-7046	439948	18-3059
393988	18-6759	398327	18-7830	435491	18-3544	439967	18-2672
394176	18-6759	398331	18-6025	435548	18-6277	458625	18-0153
394394	18-3401	398338	18-7352	435673	18-3129	458625	18-0411
394408	18-1222	398387	18-7352	435676	18-7220	473424	18-1211
394409	18-3500	398452	18-7223	435676	18-7248	500421	37477
394411	18-1506	398453	18-7223	435677	18-7220	500422	37478
394461	18-4063	398483	18-4064	435677	18-7248	500423	37479
394462	18-1752	398514	18-7821	435678	18-7220	502036	18-1402
394488	18-4148-1	398526	18-7046	435678	18-7248	502867	18-8063
394534	18-3059	398532	18-7043	435748	18-3059	502880	18-5196
394543	18-7352	398549	18-8009EP-1	435752	18-7220	502881	18-5172
394546	18-4306	398549	18-8009S	435752	18-7248	502888	18-5192
394711	18-3327	398602	18-1282	435760	18-2325	502890	18-5194
394885	18-4309	398729	18-7042	435761	18-2328	502900	18-7875
394930	18-3904	398729	18-7222	435821	18-3059	502901	18-7876
395060	18-3390	398901	18-1368	435929	18-3315-2	502903	18-7879-1
395072	18-3391	431708	18-6095	435957	18-3501	502904	18-7878-1
395073	18-3393	431708	18-6095A	435959	18-3405	502905	18-7846
395091	18-7350	431844	18-3974	436195	18-3561	502905	18-7946
395204	18-5825	431870	18-3975	436232	18-2326	502906	18-7789
395207	18-5640	431897	18-7219	436234	18-2327	502906	18-7989

*Para localizar el número de página, consulte el índice / referencia de la página 750 a 781

OMC cont.		OMC cont.		OMC cont.		OMC cont.	
503747	18-8807-1	582642	18-5760	586277	18-5631	908194	18-7400
503748	18-8800-1	582705	18-5782	586279	18-5624	908237	18-3881
503749	18-8811-1	582708	18-5808	586281	18-5648	908383	18-7401
503749	18-8814-1	582811	18-5783	586284	18-5632	908611	18-2946
503749	18-8841-1	582995	18-5181	586285	18-5628	908717	18-0183
503750	18-8801-1	583110	18-5784	586286	18-5612	908717	18-0183-1
503751	18-8810-1	583114	18-5761	586287	18-5612	908765	18-0435
503752	18-8802-1	583170	18-5763	586288	18-5640	908929	18-15455
503752	18-8803-2	583266	18-5832	586343	18-5884	908935	18-2850
503752	18-8823-1	583298	18-5170	586661	18-5781	909048	18-7477
503753	18-8842-1	583380	18-5758	586667	18-5893	909121	18-2183
503754	18-8820-1	583408	18-5708	586696	18-5764	909314	18-2902
503755	18-8802-1	583473	18-5627	586730	18-5801	909314	18-2902-1
503755	18-8803-2	583476	18-5893	586731	18-5619	909316	18-7403
503755	18-8823-1	583482	18-5624	586774	18-5833	909515	18-0548
503756	18-8843-1	583605	18-5891	586842	18-5801	909527	18-2768
508105	18-2613	583689	18-5832	678882	18-7093	909529	18-0947
508180	MP39760	583737	18-5176	763364	18-7903	909533	18-3365
508235	1525607	583740	18-5170	763735	18-3090	909613	18-0418
508626	18-3543	583748	18-5766	763793	18-5782	909747	18-7404
508713	18-0340	583865	18-5885	763794	18-5783	909748	18-0188
508871	18-0348	583896	18-5794	763803	18-5774	909753	18-2185
508872	18-0407	584028	18-5770	764354	18-9530-3	909758	18-0434
508876	18-0411	584032	18-5771	764357	18-9540-3	909786	18-0943-1
509395	18-7278	584037	18-5893	764708	18-5755	909786	18-0943-2
509404	18-7283	584041	18-5772	765012	18-3803	909818	18-15500
509407	18-7282	584107	18-6761	765350	18-3104-1	909829	18-0549
509408	18-7284	584122	18-5886	766779	18-2964	909830	18-0550
509409	18-7274	584128	18-5813	766870	18-2950	909835	18-0891
509410	18-7275	584329	18-5794	771839	18-7920	909863	18-1921
510364	18-5224	584331	18-5794	772577	18-4911	909902	18-0913
510883	18-5226	584416	18-5705	772578	18-4913	909971	18-15460
552906	18-3744	584424	18-5832	772579	18-4914	910048	56507
553126	18-7172	584476	18-5827	772584	18-5226	910113	18-0673
554545	18-7146	584477	18-5181	772681	18-8063	910139	18-7855
580148	18-5156	584488	18-5883	772831	18-7609-1	910169	18-5399
580256	18-5200	584489	18-5794	775518	18-3002	910236	18-2911
580290	18-5157	584561	18-5176	775519	18-3003	910305	18-75100
580321	18-5199	584580	18-5823	775521	18-3006	910343	18-15415
580339	18-5750	584632	18-5194	775613	18-9013	910384	18-4009
580740	18-5193	584636	18-5781	775613	18-9024	910414	18-15380
581027	18-5750	584641	18-5831	775613	18-9065	910582	18-7174
581032	18-5194	584642	18-5773	775613	18-9080	910641	18-7792
581130	18-5163	584643	18-5877	775640	18-8056	910995	18-2216
581207	18-5141	584783	18-5767	775641	18-8092	911019	18-2066
581311	18-5753	584799	18-5619	777120	18-9540-7	911311	18-7406
581397	18-5755	584818	18-5631	777130	18-3086	911616	18-8021
581407	18-5196	584890	18-5826	777213	18-3083	911662	18-02062
581419	18-5205	584908	18-5768	777228	18-9530-7	911663	18-02063
581528	18-5814	584980	18-5632	778885	18-7915-1	911664	18-02064
581610	18-5192	584981	18-5878	778886	18-7896	911665	18-02065
581713	18-5757	584985	18-5887	778887	18-7897	911666	18-02066
581726	18-5754	585001	18-5827	778888	18-7895	911667	18-02067
581731	18-5753	585050	18-5648	778992	18-5640	911668	18-0207
581778	18-5709	585051	18-5634	778994	18-5628	911669	18-0209
581786	18-5172	585056	18-5624	778995	18-5617	911669	18-0211
581805	18-5759	585057	18-5634	778996	18-5631	911670	18-0209
582048	18-6761	585058	18-5648	787133	18-9125	911670	18-0211
582056	18-5756	585059	18-5627	787145	18-9125	911671	18-0209
582057	18-5757	585060	18-5628	787145	18-9141	911671	18-0211
582091	18-5192	585061	18-5629	797407	18-3015	911672	18-0209
582115	18-5762	585062	18-5640	907761	18-0114	911672	18-0211
582125	18-5759	585063	18-5630	907764	18-0104	911673	18-0209
582138	18-5760	585114	18-5781	907774	18-3111	911673	18-0211
582155	18-6761	585134	MP28870	907775	18-2883-1	911674	18-0209
582160	18-5194	585145	18-5774	907866	18-3731	911674	18-0211
582261	18-5764	585189	18-5780	907932	18-2830	911675	18-0209
582285	18-5763	585219	18-5828	907932	18-2830-1	911675	18-0211
582365	18-5231-1	585261	18-5785	908013	18-2875	911676	18-0209
582365	18-8815-1	585267	18-5679	908013	18-2875-1	911676	18-0211
582365	18-8816-1	585269	18-5678	908013	18-2875-1-9	911677	18-0209
582365	18-8818-1	585459	18-5627	908013	18-2875-9	911678	18-0211
582366	18-5176	585995	18-5831	908034	18-7859	911678	18-0227
582382	18-5193	586000	18-5832	908062	18-4251	911679	18-0229
582399	18-5708	586048	18-5829	908063	18-2176	911680	18-02060
582400	18-5760	586075	18-5830	908064	18-3725	911681	18-02061
582452	18-5758	586212	18-5781	908069	18-2177	911685	18-2067
582453	18-5758	586217	18-5893	908079	18-2912	911686	18-7169
582472	18-5705	586224	18-5705	908079	18-2912-1	911693	18-1701
582508	18-5179	586271	18-5831	908087	18-2184	911698	18-0911
582556	18-5760	586274	18-5617	908158	18-3153	911700	18-7407

OMC cont.		OMC cont.		OMC cont.		OMC cont.	
911701	18-2068	914743	18-0654	982352	18-7018	984982	18-5908
911702	18-2916	914787	18-15450	982364	18-5957	985050	18-2218
911703	18-3121	914816	18-4161	982384	18-7070	985052	18-7017
911704	18-2541	914817	18-1213	982422	18-1099	985063	18-5812
911705	18-0166	914820	18-1239	982424	18-2186	985064	18-5801
911718	18-7408	914849	18-3877	982438	18-6019	985083	18-3937
911734	18-4837	914930	18-3879	982515	18-3584	985218	18-5397
911750	18-4828	914971	18-3876	982517	18-3584	985237	18-6759
911751	18-3768	915025	18-2909	982537	18-7081	985316	18-1401
911752	18-3610	915236	18-4160	982539	18-7096	985429	18-3583
911753	18-3769	915272	18-2383	982554	18-3558	985429	18-3599-1
911787	18-2138	915325	18-3887	982650	18-5899	985518	18-2674
911795	18-8349	915326	18-0468	982706	18-6755	985560	18-5313-1
911797	18-2533	915702	18-2068	982880	18-5403	985602	18-7278
911820	18-4250	915716	18-2104	982946	18-2665	985603	18-7278
911823	18-2996	915717	18-2174	982947	18-2664	985612	18-2671
911826	18-2763	915719	18-0440	982948	18-2670	985613	18-2672
911836	18-2918	915720	18-4833	982949	18-2667	985630	18-0868
911844	18-3145	915735	18-5433	982957	18-6257	985799	18-5837
911851	18-7153	915840	18-2918	982997	18-7289	985822	18-7615-1
911871	18-7409	916058	18-2068	983195	18-6257	985902	18-5889
911878	18-0880	916262	18-0183	983218	18-3386	985966	18-5911
911937	18-3770	916262	18-0183-1	983247	18-6842	986007	18-5908
912029	18-4835	976669	18-6020	983296	18-3577-1	986074	18-3577-1
912157	18-0190	979659	18-7072	983298	18-3119	986103	18-0410
912164	18-1204	979719	18-7080	983318	18-6764	986104	18-0410
912164	18-1204-1	979774	18-5803	983424	18-6841	986120	18-21752-1
912164	18-1204-1-9	980014	18-1712	983424	18-6842	986144	18-2437
912164	18-1204-9	980152	18-5386	983444	18-5911	986145	18-2438
912212	18-2146	980183	18-2156	983494	18-6101	986232	18-21754
912213	18-2128	980477	18-3583	983538	18-7081	986280	18-6779
912214	18-2104	980477	18-3599-1	983790	18-5911	986336	18-3937
912227	18-3879	980528	18-7608-1	983825	18-1600	986338	18-21751
912374	18-2745	980530	18-7609-1	983826	18-1601	986364	18-2673
912405	18-0956	980613	18-5897	983836	18-6841	986380	18-4806
912405	18-0956-1	980617	18-1876	983836	18-6842	986381	18-4804
912418	18-15500	980803	18-5903	983855	18-7615-1	986382	18-4805
912424	18-75100	980892	18-5407	983864	18-7095	986423	18-2674
912441	18-1902	980893	18-5303	983870	18-7855	986505	18-5910
912442	18-1903	980894	18-5347	983871	18-7201	986620	18-5837
912471	18-0431	980902	18-5309-1	983877	18-1172	986629	18-2783
912477	18-0430	980959	18-1904	983878	18-1171	986642	18-5108
912509	18-15435	981078	18-5911	983880	18-2338	986643	18-5361
912614	18-3502	981080	18-5312-1	983891	18-1161	986651	18-5406
912714	18-15520	981195	18-2071	983892	18-1170	986658	18-0647
912766	18-3878	981196	18-2072	983895	18-3058	986779	18-3575
912768	18-0464	981268	18-2073	983902	18-21751	986782	18-7236
912793	18-75125	981288	18-5908	983937	18-2100	986783	18-7235
912954	18-0468	981289	18-5907	983967	18-4750	986784	18-7237
912955	18-0405	981359	18-7615-1	983973	18-2765	986796	18-7238
912965	18-2845	981428	18-7615-1	984012	18-1602	986799	18-7237
912978	18-4408	981564	18-7615-1	984054	18-1901	986800	18-7239
912979	18-1238	981566	18-7229	984180	18-7609-1	986804	18-7241
912981	18-0347	981650	18-7268	984264	18-6399	986865	18-7229
912988	18-0887	981705	18-7615-1	984290	18-21752-1	987136	18-5303
912989	18-1213	981797	18-2663	984356	18-6814	987251	18-2791
913270	18-0664	981799	18-2666	984360	18-3575	987313	18-7242
913275	18-0887	981801	18-2669	984398	18-5353	987315	18-7243
913276	18-2815	981803	18-7615-1	984401	18-5352	987317	18-7244
913277	18-0347	981821	18-5903	984456	18-5910	987319	18-7245
913393	18-0401	981911	18-7861	984458	18-2672	987438	18-7246
913488	18-75100	982019	18-6950	984459	18-2673	987440	18-7246
913745	18-0528	982058	18-6755	984461	18-3212-1	987447	18-3577-1
913758	18-0352	982063	18-7267	984461	18-3348	987467	18-2765
913783	18-0943-1	982069	18-6764	984487	18-7086	987485	18-7246
913783	18-0943-1-9	982073	18-6764	984491	18-7854	987603	18-2673
913783	18-0943-2	982121	18-5911	984513	18-6028	987661	18-2245-1
913783	18-0943-2	982132	18-2595	984513	18-6028A	987678	18-2246
913783	18-4431	982195	18-5908	984513	18-6102	987738	18-5888
913783	18-4431-9	982202	18-5907	984536	18-6270	987739	18-5889
913784	18-1909-1	982209	18-5376	984536	18-6276	987740	18-5890
914036	18-2764	982211	18-5404-1	984537	18-21754	987774	18-6261
914323	18-0518	982217	18-7608-1	984547	18-6103	987784	18-1922
914445	18-4024	982217	18-7609-1	984547	18-6103A	987811	18-5920
914488	18-8369	982219	18-7608-1	984628	18-5917	987894	18-5303
914555	18-3937	982223	18-7615-1	984629	18-21755	987895	18-5347
914556	18-3939	982230	18-7862	984744	18-3206	987925	18-5258
914557	18-3938	982240	18-7278	984748	18-7634	987926	18-5260
914716	18-2383	982277	18-6019	984765	18-4806	987986	18-5413
914723	18-0652	982336	18-5369	984770	18-4804	988013	18-6270
914736	18-0655	982342	18-5411	984771	18-4805	988013	18-6276

*Para localizar el número de página, consulte el índice / referencia de la página 750 a 781

VOLVO cont.		VOLVO cont.		VOLVO cont.		VOLVO cont.	
17461-87E12	18-3049	31100-95J00	18-6945	243799	18-5305	832598	18-6000
17461-90J00	18-3023	31100-95J01	18-6945	243801	18-5319	832598	18-6000A
17461-90J01	18-3023	31100-96J00	18-6941	243903	18-5428	832598	18-6104
17461-92D02	18-3000	31100-96J01	18-6941	273663	18-7783	832669	18-2990
17461-93001	18-3092	31173-95310	18-56008	275595	18-3167	832675	18-2199
17461-93003	18-3092	31173-99E00	18-56009	324825	18-8204	832820	18-4205
17461-93004	18-3092	32140-93900	18-5152	328516	18-3938	832831	18-2776
17461-93901	18-3099	32900-93911	18-5144	329653	18-8203	832846	18-2778
17461-93902	18-3099	33410-92L10	18-5151	370409	18-3944	832965	18-4234
17461-93903	18-3099	33410-94400	18-5151	416033	18-2933	833188	18-4463
17461-93J00	18-3035	37100-87J00-OEP	18-18304	418265	18-2974	833274	18-3842
17461-94500	18-3023	37110-99-E00	MP51010	418411	18-2935	833453	18-3834
17461-94501	18-3023	37110-99-E00	MP51012	418412	18-2937	833950	18-4005
17461-94502	18-3023	38100-87000-OIT	18-6785	418445	18-2936	833995	18-3076
17461-94503	18-3023	38100-87D10-OED	18-6786-1	418754	18-2975	833996	18-2044
17461-94504	18-3023	38100-87D10-OIT	18-6786-1	418870	18-2922	834337	18-7884
17461-94505	18-3023	38100-87D10-35J	18-6786-1	419310	18-2965	834476	18-2531
17461-94506	18-3023	38100-87E10-OED	18-6785	419652	18-4474	834520	18-5806
17461-94510	18-3023	38100-87E20-OED	18-6785	419653	18-4473	834548	18-4044
17461-94511	18-3023	38100-87J0EP	18-18304	419678	18-2923	834560	18-5348
17461-94520	18-3023	38100-87J11	18-6793	419734	18-4468	834609	18-5959
17461-94700	18-3094	38100-87J11	18-6837	419735	18-4470	834751	18-2766
17461-94701	18-3094	38100-87J20	18-6793	423135	18-7926	834893	18-5911
17461-95300	18-3095	38100-87J20	18-6837	430017	18-2518	834963	18-5959
17461-95301	18-3095	38100-92E00-OED	18-6786-1	430018	18-2525	834975	18-5425
17461-95302	18-3095	38100-92J02	18-18303	430020	18-2994	835304	18-5314
17461-96301	18-3096	38100-92J10	18-18303	430039	18-2924	835308	18-5338
17461-96311	18-3096	38100-93J01	18-18303	430107	18-2812	835390	18-3583
17461-96312	18-3096	38100-93J02	18-18303	430143	18-7878-1	835390	18-3599-1
17461-98501	18-3097	38100-96J00	18-18303	430172	18-2526	835417	18-0398
17461-98502	18-3097	38860-76F01	18-5731	461092	18-2925	835512	18-3060
17461-98503	18-3097	48600-94511-OED	18-6865	461511	18-1479	835576	18-7859
17461-985M0	18-3097	55125-87D00	18-6033	461618	18-2811	835702	18-5369
17462-93990	18-3292	55125-96310	18-6098	462623	18-2966	835704	18-5345
17471-87D01	18-3189	55320-95310	18-6032	463377	18-4029	835705	18-5303
17471-87E01	18-3192	56132-95J00	18-0650	463505	18-7890	835804	18-1931-1
17471-92D10	18-3193	57630-92E00	18-3775	463587	18-2926	835874	18-3047
17471-92J00	18-3192	57630-94300	18-3777	463902	18-4245	835874	18-3061
17471-93902	18-3190	57630-94500	18-3774	463904	18-4247	835966	18-2949
17471-94501	18-3191	57630-96300	18-3778	463999	18-2927	835998	18-5433
17471-98503	18-3188	65700-87J10	18-8035EP-1	466634	18-7880	837924	18-6872
17472-91J00	18-0761	65700-95513	18-8018EP-1	466987	18-7942	838513	18-70704
17472-92D10	18-0479	65720-94401	18-80409	477024	18-4200	838593	18-7940
17472-93911	18-0478	65720-94411	18-8087	477556	18-0034	838637	18-4466
17472-93J00	18-0778	65720-986B0	18-80425	478736	18-0033	838638	18-4471
17472-95200	18-0459	65740-95500	18-8078	502036	18-1402	838928	18-6021
17472-95310	18-0460	65750-87J10	18-80419	803762	18-1727	838929	18-6001
17472-96301	18-0461	65750-87J11	18-80419	804190	18-0184	839423	18-4208
17472-98503	18-0477-9	65750-94404	18-80418	804261	18-4259	839430	18-6790
17472-98611	18-0480	65750-95500	18-8079	804695	18-2039	839534	18-4209
17472-98J00	18-0651	65750-95510	18-8079	806256	18-3106	840808	18-5906
17582-93J00	18-0793	65750-98505	18-8062	807036	18-4216	841070	18-5352
17685-87D10	18-0797	990C0-10W40-1GL	18-9551-3	808007	18-3274	841161	18-7286
17685-97J00	18-0794	990C0-10W40-1QT	18-9551-2	812994	18-4150	841162	18-7862
17685-98J00	18-0795	99105-00192	18-8071	813967	18-8368	841177	18-6268
17685-99E00	18-0796	99105-00193	18-8078	814301	18-2153	841207	18-3876
18213-98J00	18-32154	99105-20004-BWL	18-7922	814356	18-2939	841243	18-5411
25223-94400	18-8334	99105-20004-BWL	18-7922-1	818525	18-5419	841244	18-5375
25700-87D00	18-8335	99105-20005	18-7948	820652	18-59710	841262	18-5349
25700-90J01	18-8373	99105-20006	18-7947	822454	18-59710	841263	18-5358
25700-92J00	18-8374	99105-20006-BWL	18-7987	824633	18-2928	841292	18-7000
25700-93J00	18-8380			824677	18-2989	841380	18-59700
25700-94400	18-8337			824803	18-7099	841640	18-3586
25700-94500	18-8338			826341	18-4204	841750	18-7879-1
25700-94700	18-8339	35254	18-5436	826423	18-75125	841762	18-5959
25700-95500	18-8340	82744	18-4217	826493	18-7281	841762	18-59700
25700-95D00	18-8341	82745	18-4218	826495	18-5959	841763	18-59700
25700-95J00	18-8385	125017	18-7178	826648	18-7888	841765	18-5959
25700-98J00	18-8386	174448	18-9098	827247	18-2045	841765	18-59700
25700-99E00	18-8381	181620	18-2057	827303	18-59710	841766	18-5959
31100-89J00	18-6419	192212	18-4201	829207	18-15460	841766	18-59700
31100-90J00	18-6831	233991	18-6872	829592	18-4219	841821	18-15430
31100-92E00	18-6417	240149	18-5306	829620	18-4464	841907	18-5403
31100-93J00	18-6941	240501	18-6872	829714	18-2934	841926	18-5353
31100-94600	18-6827	241669	18-5393	829913	18-8124	841994	18-7086
31100-94601	18-6827	241812	18-6271	831009	18-3106	842775	18-6872
31100-94610	18-6416	243460	18-5305	831617	18-2527	843511	18-6872
31100-94610	18-6827	243632	18-5357	831622	18-2519	845261	18-4007
31100-94702	18-6429	243653	18-5342	831891	18-2528	845363	18-28050
31100-95313	18-6428	243658	18-5394	831892	18-2529	845792	18-75125
31100-95600	18-6414	243797	18-5356	832570	18-4206	847651	18-59710

*Para localizar el número de página, consulte el índice / referencia de la página 750 a 781

VOLVO cont.		VOLVO cont.		VOLVO cont.		VOLVO cont.	
847741	18-0032	873178	18-6004	876384	18-0489	1378646	18-2970
849561	18-59710	873178	18-6004A	876433	18-2818	1378864	18-2926
849602	18-59710	873178	18-6105	876631	18-2758	1378870	18-2972
850046	18-6791	873179	18-6000	876633	18-2757	1378879	18-2930
850785	18-4210	873179	18-6000A	877066	18-3275	1378906	18-2979
850834	18-6758	873179	18-6104	877349	18-3658	1378909	18-2927
850888	18-4211	873228	18-2432	881681	18-6872	1378911	18-2922
850889	18-4212	873229	18-2433	881682	18-6958	1378913	18-2925
851120	18-6951	873395	18-6123Z	897367	18-4214	1502272	18-6846
851261	18-4213	873770	18-5939	897426	18-2041	1542389	18-4469
851407	18-0558	875192	18-2625	897707	18-2104	1542472	18-4467
852520	18-6791	875363	18-28050	897720	18-6792	2430184	18-3037
852835	18-6004	875383	18-3209	897873	18-4239	2430184	18-3078
852835	18-6004A	875400	18-2983	908611	18-2946	2655301	18-6847
852835	18-6105	875401	18-2980	912213	18-2128	2656299	18-6848
852928	18-6274	875407	18-7085	912227	18-3879	3287677	18-5745
852928	18-6838	875422	18-2596	912957	18-0519	3517857	18-7878-1
852928	18-6881	875550	18-2793	912979	18-1238	3523301	18-6839
853012	18-710-64-2	875569	18-2982	914323	18-0518	3547991	18-2530
853012	18-7315	875571	18-8813-1	914445	18-4024	3580309	18-0498
853255	18-2104	875574	18-3205	914556	18-3939	3582310	18-35443
853548	18-7306	875575	18-3075	914557	18-3938	3582358	18-7908
853670	18-2040	875580	18-3666	914816	18-4161	3582561	18-4473
853868	18-25251	875583	18-3076	914930	18-3879	3582606	18-4474
854031	18-2777	875584	18-3208	915236	18-4160	3582609	18-4465
854045	18-4210	875660	18-3037	925054	18-7179	3582732	18-0035
854047	18-4213	875660	18-3078	925055	18-7180	3582733	18-0036
854329	18-6792	875698	18-3263	925065	18-7190	3583443	18-8125
854346	18-6770	875736	18-3037	925091	18-7181	3583555	18-6944
855326	18-5911	875736	18-3078	925092	18-7182	3583786	18-3868
855383	18-2991	875741	18-8357	925093	18-7183	3586461	18-6125A
855383	18-2991-1	875759	18-3262	925095	18-7122	3586498	18-3079
855387	18-1930-2	875769	18-3261	925256	18-7184	3586765	18-6838
855507	18-6456	875779	18-3654	925259	18-7186	3587079	18-6806
855798	18-5657	875781	18-3656	925261	18-7187	3587597	18-3615
855845	18-5403	875784	18-3658	941816	18-4215	3587625	18-5913
855889	18-7072	875785	18-3659	941907	18-4236	3588378	18-7940
855967	18-2991	875787	18-3660	943218	18-4238	3588475	18-3504
855967	18-2991-1	875791	18-3663	943414	18-2367	3803227	18-5943
856028	18-2929	875794	18-3662	946242	18-2046	3803227	18-59700
856034	18-2949	875795	18-3664	949656	18-7154	3803260	18-5939
856037	18-2995	875796	18-3665	950813	18-15410	3803645	18-6953
856044	18-2928	875805	18-6005	950818	18-15460	3808516	18-7708
856116	18-2909	875808	18-3080	951924	18-4241	3825038	18-79007
856306	18-70704	875815	18-6009	952141	18-15500	3825133	18-7942
856364	18-3583	875815	18-6009A	955974	18-7193	3827069	18-7974
856364	18-3599-1	875821	18-6010	955983	18-7188	3831424	18-3538
856470	18-7099	875821	18-6010A	955989	18-7149	3831425	18-3660
856471	18-7000	875821	18-6106	955995	18-7192	3831426	18-3539
856472	18-7000	875822	18-2775	956000	18-7194	3840335	18-7709
856474	18-3876	875826	18-2744	958303	18-15325	3841697	18-3038
856609	18-3577-1	875827	18-2755	958310	18-15390	3841697	18-3077
856883	18-1931-1	875828	18-2757	958311	18-15405	3841697	18-30777
856891	18-1935-1	875847	18-2774	958314	18-15435	3842343	18-9410-2
856894	18-1932	875848	18-2758	958320	18-15495	3842344	18-9410-4
857037	18-1936	876037	18-5704	958357	18-15415	3843751	18-7705
858201	18-7858	876038	18-6271	958498	18-4046	3847501	18-1986-1
858459	18-35444	876039	18-5705	958838	18-2043	3847547	18-9096
858467	18-3175	876040	18-6266	958860	18-2047	3847644	18-8149
858488	18-7907	876069	18-57702	966382	18-15435	3850216	18-5811
859155	18-3843	876097	18-3656	966857	18-4046	3850357	18-7677
859428	18-35442	876120	18-3287	975672	18-7181	3850379	18-1238
859647	18-3867	876185	18-7890	984513	18-6028	3850379	18-4408
860874	18-7940	876267	18-8358	985316	18-1401	3850396	18-7684
861250	18-0307	876268	18-8359	985727	18-21753	3850426	18-1074
861251	18-0310	876278	18-4204	986280	18-6779	3850495	18-2875
861477	18-8126	876279	18-2366	988037	18-7330	3850495	18-2875-1
862293	18-7888	876294	18-2744	1141679	18-9680-2	3850495	18-2875-1-9
870670	18-6271	876300	18-2998	1141681	18-9680-5	3850495	18-2875-9
870690	18-5357	876302	18-2813	1141682	18-9680-7	3850496	18-0943-1-9
870998	18-6958	876303	18-3870	1218630	18-4472	3850496	18-0943-2
872066	18-7647	876305	18-3662	1218674	18-1478	3850496	18-4431
872235	18-5939	876306	18-2814	1243632	18-5357	3850496	18-4431-9
872241	18-5906	876314	18-0252	1266286	18-7878-1	3850559	18-7876
872272	18-6268	876337	18-2816	1266796	18-2930	3850594	18-2586
872300	18-6266	876342	18-2983	1306169	18-5305	3850595	18-0893
872449	18-6838	876356	18-2980	1306630	18-4031	3850597	18-2791
872449	18-6881	876358	18-2982	1317466	18-2933	3850809	18-7326
872793	18-6124Z	876359	18-2817	1336255	18-2530	3850810	18-7331
872926	18-5943	876376	18-4342	1357199	18-6839	3850812	18-2174
873051	18-6838	876380	18-4341	1378645	18-2968		

VOLVO cont.		VOLVO cont.		YAMAHA cont.		YAMAHA cont.	
3850813	18-2128	3853807	18-2100	3857561	18-6261	40005011	18-9553-2
3850814	18-2337	3853815	18-5352	3857650	18-7330	40005012	18-9553-3
3850815	18-2146	3853827	18-1230	3857656	18-1848	40005013	18-9553-5
3850861	18-7778	3853847	18-1401	3857723	18-1986-1	40005014	18-9553-7
3850984	18-3708-1	3853850	18-3583	3857747	18-6275	1357199-7	18-6839
3852005	18-3722	3853850	18-3599-1	3857813	18-6265	17253-6	18-3745
3852023	18-1501	3853869	18-5837	3857985	18-7331	3523301-4	18-6839
3852033	18-7168	3853912	18-0410	3857986	18-7326	3803227-2	18-59700
3852044	18-7162	3853913	18-0410	3858061	18-9410-7	3851218-2	18-7789
3852045	18-7116	3853945	18-6779	3858071	18-6805	3851218-2	18-7989
3852073	18-7102	3853960	18-3937	3858071	18-6817	3852374-2	18-1986-1
3852089	18-7135	3853982	18-5913	3858081	18-5700	3852648-9	18-3730
3852095	18-0889	3853983	18-3676	3858256	18-3081	3853862-5	18-21753
3852096	18-0164	3853998	18-5837	3858261	18-7326	3853962-3	18-21751
3852109	18-0874	3854001	18-5108	3858462	18-15450	3854194-2	18-6291
3852113	18-0876	3854002	18-5443	3858714	18-7331	3855270-9	18-1909-1
3852127	18-2858	3854003	18-5107-1	3858809	18-5700	3855270-9	18-1909-1
3852165	18-7141	3854017	18-3575	3858941	18-7685	3856600-6	18-6261
3852169	18-7143	3854018	18-36905	3858967	18-33201	3857846-4	18-2434
3852170	18-8020	3854020	18-7238	3858979	18-7706	3858437-1	18-21752-1
3852171	18-8200	3854026	18-7229	3859054	18-5811	419763-8	18-2965
3852172	18-8202	3854033	18-1402	3859078	18-7493	463903-5	18-4246
3852255	18-3744	3854095	18-1231	3859082	18-7643	5003564-1	18-6839
3852315	18-32882	3854105	18-7242	3860082	18-5979	576266-8	18-8361
3852350	18-4194	3854106	18-7244	3860566	18-6275	818701-5	18-5310
3852384	18-2339	3854107	18-7245	3860764	18-5913	834438-4	18-1930-2
3852413	18-7789	3854116	18-7246	3860769	18-5957	834625-6	18-59700
3852413	18-7989	3854127	18-2765	3860879	18-6806	834985-4	18-7095
3852455	18-0183	3854130	18-6125Z	3861267	18-7648	835908-5	18-2971
3852455	18-0183-1	3854158	18-7601	3861575	18-6804	835908-5	18-2971-1
3852464	18-15455	3854161	18-7492	3862228	18-7989	841047-4	18-7641
3852468	18-2902	3854164	18-69550	3862281	18-3081	841066-4	18-5903
3852468	18-2902-1	3854190	18-5920	3862281	18-3277	841293-4	18-7001
3852472	18-0418	3854202	18-3869	3862500	18-7513	841313-0	18-7641
3852476	18-0549	3854215	18-29322	3862567	18-3276-1	841378-3	18-59700
3852477	18-0891	3854217	18-29322	3862612	18-6848	841634-9	18-7200
3852523	18-7406	3854217	18-5248	3862613	18-6845	841836-0	18-7000
3852529	18-8021	3854218	18-5413	3862613	18-6847	847306-8	18-6872
3852531	18-7407	3854252	18-3939	3862665	18-6845	847308-4	18-6958
3852544	18-2138	3854261	18-5406	3863061	18-1909-1	849748-9	18-6955
3852560	18-2996	3854269	18-0868	3863061	18-1909-1	855384-4	18-1935-1
3852604	18-710-48-2	3854280	18-7330	3863085	18-25250	855846-2	18-5303
3852654	18-0468	3854286	18-3046	3863130	18-7642	856039-3	18-2971
3852655	18-0405	3854286	18-3060	3863193	18-6028A	856039-3	18-2971-1
3852656	18-0322	3854299	18-3879	3863450	18-2780-1	875807-0	18-3079
3852657	18-0519	3854311	18-5408	3863450	18-2780-1	875808-8	18-3036
3852687	18-0664	3854331	18-5362	3884950	18-5882	875811-2	18-3081
3852691	18-0887	3854406	18-0410	3884950	18-6845	876532-3	18-8801-1
3852692	18-2815	3854512	18-7703	3885317	18-5913	877061-2	18-3038
3852693	18-0347	3854527	18-7702	3888813	18-6127A	877061-2	18-3077
3852696	18-2779	3854539	18-2454	3888814	18-6127Z	966694-2	18-4044
3852741	18-2780-1	3854548	18-5354	3888815	18-6127M	R7044289	18-80008
3852742	18-2781	3854549	18-5405	3888816	18-6126A	R80316	18-79998
3852805	18-0528	3854620	18-7326	3888817	18-6126Z	R80378	18-80009
3852818	18-0352	3854751	18-5913	3888818	18-6126M	R80382	18-80006
3852824	18-0147	3854905	18-7679	3888821	18-2583	R80383	18-80007
3853132	18-0518	3854942	18-0311	3888822	18-2584	72021	18-6846
3853226	18-4024	3854956	18-0518	3888916	18-1076	820545	18-6822
3853256	18-0680	3855017	18-7241	3888917	18-2726	845940	18-6846
3853268	18-3937	3855104	18-7792	3911020	18-4173	872022	18-6846
3853336	18-2946	3855182	18-7689	3911023	18-4164	872757	18-6846
3853340	18-4161	3855194	18-7704	4785974	18-7926	873635	18-6846
3853341	18-1213	3855275	18-2598	5003564	18-6839	873757	18-6846
3853342	18-0327	3855276	18-7268	6209190	18-6956	3852215	18-5894
3853343	18-1239	3855296	18-7757	6643474	18-6271	5001677	18-6846
3853361	18-0903	3855411	18-6028	8602629	18-6953	3803270-2	18-6846
3853412	18-2909	3855412	18-6102	8602710	18-6953	852928,	18-6822
3853477	18-4160	3855610	18-6125M	8602714	18-6953	854525-3	18-6817
3853510	18-1232	3855958	18-7330	8676496	18-6953	873757-9	18-6846
3853511	18-3887	3855991	18-3577-1	8676498	18-6953	873771,	18-6846
3853512	18-0468	3856003	18-5919	8676499	18-6953	949658-9	18-7147-9
3853528	18-1234	3856004	18-5913	8692305	18-8003		
3853587	18-3873	3856127	18-1400	8757166	18-8802-1		
3853732	18-3883	3856138	18-1237	8757166	18-8823-1		
3853742	18-0183	3856393	18-7641	17059059	18-80005	19-1400-10	18-6843
3853742	18-0183-1	3856884	18-33800	21124846	18-3506	1WD-E3440-00-00	18-8700
3853787	18-5897	3856961	18-3677	21148403	18-3557	2MB-E3440-00-00	18-8700
3853796	18-3584	3857265	18-6274	21213660	18-3276-1	3FV-13440-00-00	18-7902
3853799	18-3558	3857487	18-7700	21213664	18-30778	5GH-13440-00-00	18-7911-1
3853801	18-5403	3857489	18-6806	21323043	18-6944	5GH-13440-20	18-8700
3853804	18-8964	3857532	18-5899	21436799	18-5467	5JW-13400-00-00	18-8700
						60E-81800-00-00	18-6921

YAMAHA

*Para localizar el número de página, consulte el índice / referencia de la página 750 a 781

YAMAHA cont.		YAMAHA cont.		YAMAHA cont.		YAMAHA cont.	
60V-11181-00	18-99048	62L-85570-00-00	18-5129	650-11651-04-00	18-1755K	66T-15713-00-00	18-51003
60V-12411-00	18-3525	62T-85520-00-00	18-5147	650-24431-00	18-0849	66T-41114-A0-00	18-60532
60V-12414-A0-00	18-60508	62T-85520-01-00	18-5147	650-24431-A0-00	18-0849	66T-41133-A0-00	18-60529
60V-13621-A0	18-99049	62T-85533-00-00	18-5146	655-12414-A1-00	18-0232	66T-44311-00	18-3413
60V-13645-00	18-99050	62X-43880-00-00	18-6811	65E-85570-00-00	18-5119	66T-44323-00-00	18-3196
60V-13907-00-00	18-7343	62X-43880-00-00	18-6812	65L-13645-00	18-99066	66T-45113-A0-00	18-60528
60V-24251-01-00	18-79907	62X-43880-01-00	18-6811	65L-13646-00	18-99067	66T-W0078-00	18-3413
60V-43880-00-00	18-6798	62X-43880-01-00	18-6812	65L-14984-00	18-0715	66T-W0078-00-00	18-3440
60V-81800-00-00	18-6832	62X-43880-09-00	18-6789	65L-24564-00-00	18-7487	66V-81960-00-00	18-6651
60X-43315-A0-00	18-0406	62X-43880-09-00	18-6812	65L-W0001-C0-00	18-74510	670-45997-02-00	18-73914
60X-44323-00-00	18-3520	62Y-12414-00-00	18-0835	65W-11169-00	18-99068	676-11181-A0-00	18-3892
60X-81800-00-00	18-6832	62Y-14392-00-00	18-7049	65W-11181-30-00	18-63968	676-11181-A1-00	18-3892
60X-W0078-00	18-3522	62Y-41133-00	18-99002	65W-11351-00	18-99069	676-12414-A0-00	18-60540
60X-W0078-00	18-3522-1	62Y-41134-01	18-99003	65W-11356-00	18-99070	676-13646-A0	18-99080
60X-W0078-00-00	18-3516	62Y-43800-00-00	18-6811	65W-13645-00-00	18-60535	676-14984-00-00	18-0840-1
61A-11181-A0-00	18-3891	62Y-43880-00-00	18-6811	65W-14198-00-00	18-76689	676-14985-01-00	18-7392
61A-11181-A1-00	18-3891	62Y-W0001-20-00	18-74540	65W-14457-10	18-99071	676-41112-A0	18-99081
61A-11193-A1	18-99051	63D-11181-A1	18-99060	65W-14901-12-00	18-34602	676-41133-A0	18-99014
61A-11381-A0	18-99052	63D-11193-A0	18-99059	65W-24251-10-00	18-7830	676-44315-A1	18-99082
61A-12414-A0-00	18-0829	63D-44316-00-00	18-0483	65W-41114-00	18-99072	676-44324-A0	18-99083
61A-13411-00	18-79976	63D-44322-00-00	18-3449	65W-41114-01-00	18-60531	676-45114-A0	18-99015
61A-13621-A0	18-99053	63D-44323-00-00	18-3186	65W-43865-00-00	18-7470	676-45127-00	18-99084
61A-13645-00	18-99054	63D-45114-A0	18-99004	65W-43871-00-00	18-7484	676-45128-00	18-99085
61A-13646-00	18-99055	63D-45123-00	18-99005	65W-81941-00-00	18-5819	677-14198-A1	18-99145
61A-24563-00-00	18-7782	63D-W0001-00	18-99061	65W-81960-10-00	18-17300	677-14384-01	18-99146
61A-24564-00-00	18-7486	63D-W0078-01-00	18-3415	65W-85510-10-00	18-25605	677-24411-02-00	18-7837
61A-41134-A0	18-99000	63D-W0078-01-00	18-3434	65W-85570-01-00	18-23205	677-24471-01-00	18-7838
61A-43880-01-00	18-6782	63M-81800-00-00	18-6908	65W-85580-00-00	18-25651	677-W0093-00-00	18-7059
61A-43880-02-00	18-6782	63M-81960-00-00	18-6857	65W-W0001-20	18-99073	677-W0093-04-00	18-7059
61A-44311-00-00	18-3173	63P-13915-00-00	18-79902	662-44352-01-00	18-3063	679-44316-A0	18-99086
61A-44311-00-00	18-3173-1	63P-14984-00	18-0712	663-13622-00-00	18-0242	679-45315-A0	18-99087
61A-44311-01	18-3522	63P-45987-00-00	18-73918	663-24410-00-00	18-7334	679-W0078-00-00	18-3397
61A-44311-01	18-3522-1	63V-11181-A2	18-99140	663-24411-00-00	18-7840	679-W0078-A0-00	18-3397
61A-44311-01	18-3523	63V-14301-00-00	18-34603	663-44311-02	18-3408	67C-11356-00	18-99088
61A-44311-01	18-3523-1	63V-14985-00	18-7064	663-44315-A0-00	18-0292	67C-41114-00	18-99089
61A-44311-01-00	18-3173	63V-15713-00-00	18-51001	663-44316-A0	18-99149	67C-41133-00	18-99016
61A-44311-01-00	18-3173-1	63V-24411-00-00	18-7390	663-44322-00-00	18-3435	67C-43880-00-00	18-6748
61N-44311-00-00	18-3185	63V-41133-A1	18-99006	663-44323-00-00	18-3436	67C-45113-00	18-99091
61A-44322-00-00	18-3333	63V-44301-00	18-3412	663-44324-A0-00	18-0294	67C-45123-00	18-99017
61A-44322-02-00	18-3519	63V-44301-00-00	18-3356	663-44366-00	18-1830	67C-W0001-00	18-99092
61A-45113-A0	18-99056	63V-44322-00-00	18-3444	663-45123-00	18-99009	67C-W0001-20	18-99093
61A-45114-A0	18-99001	63V-44323-00-00	18-3195	663-45331-00-94	18-2773	67C-W0001-21-00	18-0020
61A-45371-00-00	18-6119A	63V-44352-01-00	18-3040	663-81840-11-00	18-56004	67D-14301-13-00	18-34601
61A-45371-00-00	18-6119Z	63V-44365-10-00	18-3505	663-W0078-00-00	18-3425	67D-15713-00-00	18-51002
61A-45527-00-00	18-9076	63V-45113-A1	18-99150	663-W0078-A0-00	18-3425	67D-24410-03-00	18-35304
61A-45538-00-00	18-9075	63V-45315-A0	18-99063	664-41114-A0-00	18-0250	67D-45113-A0-00	18-60527
61A-81800-01-00	18-6861	63V-85520-00	18-5183	664-41134-A0	18-99010	67D-W0093-00-00	18-7736
61A-81840-00-00	18-56007	63V-85520-01	18-5183	664-45371-01-00	18-6096	67F-11181-02	18-99094
61A-81941-00-00	18-5853	63V-85533-00-00	18-25604	66K-13907-00-00	18-7341	67F-12411-01-00	18-3632
61A-W0001-01-00	18-4400	63V-85540-00-00	18-5132	66K-13915-00-00	18-79900	67F-14371-01	18-79972
61A-W0001-21-00	18-2799	63V-85540-01-00	18-5132	66K-14984-00	18-0711	67F1439A-00-00	18-7056
61A-W0001-A1-00	18-4400	63V-85540-02-00	18-5132	66K-W0001-20-00	18-74512	67F-41133-A1	18-99018
61A-W0001-C1-00	18-2799	63V-85570-00-00	18-23602	66L-13915-00-00	18-79901	67F-41134-A0	18-99019
61A-W0078-01-00	18-3395	63V-85580-01-00	18-25652	66M-11181-10-00	18-63966	67F-41138-00-00	18-0605
61A-W0078-A2-00	18-3396	63V-W0001-01	18-99175	66M-11351-10	18-99074	67F-43880-00-00	18-6787
61A-W0078-A2-00	18-3396-1	63V-W0001-21-00	18-74507	66M-11356-00	18-99075	67F-44311-01	18-3409
61A-W0078-A3-00	18-3396	63V-W0078-01	18-3412	66M-11357-00-00	18-60513	67F-44322-00-00	18-3162
61A-W0078-A3-00	18-3396-1	63V-W0078-01-00	18-3433	66M-12411-01-00	18-3541	67F-44323-00-00	18-3143
61A-W0093-00-00	18-7772	63V-W0093-00-00	18-7058	66M-13329-10	18-99076	67F-44352-00-00	18-3042
61A-W0093-01-00	18-7772	646-24251-02-00	18-7713	66M-13645-00-00	18-60534	67F-45123-00	18-99020
61B-82510-00-00	MP51030	646-44322-00-00	18-3328	66M-14301-00-00	18-34600	67F-45127-00-00	18-0617
61B-82510-01-00	MP51030	646-44323-00-00	18-3357	66M-14301-12-00	18-34600	67F-81800-02-00	18-6425
61B-82510-01-00	MP51032	646-44352-01-00	18-3072	66M-24410-10-00	18-35302	67F-W0001-20-00	18-74535
61N-11631-00-95	18-4144	647-14385-00-00	18-7065	66M-41114-01-00	18-60530	67F-W0078-00	18-3409
61N-11635-00-00	18-4145	647-44366-00	18-1833	66M-41133-00	18-99012	67F-W0078-00-00	18-3451
61N-11636-00-00	18-4146	647-45616-02	18-3709	66M-41138-00	18-99078	67F-W0093-00-00	18-7743
61N-14392-00-00	18-7049	648-14198-A0-00	18-0775	66M-45113-00	18-99013	67H-8592A-00-00	18-7655
61N-14392-00-00	18-7058	648-14385-00-00	18-7066	66M-45115-00	18-99079	67H-8592A-01-00	18-7655
61N-24560-10	18-79910	648-24411-00-00	18-7839	66M-81800-01-00	18-6943	680-85570-00-00	18-5138
61N-24563-00-00	18-7781	64D-14384-01-00	18-0856	66M-81800-02-00	18-6943	680-85570-02-00	18-5138
61N-44311-01-00	18-3185	64D-W0093-00-00	18-7756	66M-85520-00-00	18-25600	680-85570-09-00	18-5112
61N-44322-01-00	18-3443	64E-13645-A0	18-99064	66M-85533-00-00	18-25602	682-11351-A0	18-99095
61N-44323-00	18-3194	64E-43822-00-00	18-2081	66M-85540-01-00	18-25300	682-11610-01-00	18-3976
61N-45251-01-00	18-6120A	64E-4384J-00-00	18-2082	66M-85570-00-00	18-23601	682-11610-11-00	18-3977
61N-45251-01-00	18-6120Z	64E-43869-00-00	18-7469	66M-85580-00-00	18-25650	682-12414-A1-00	18-0836
61N-85570-00-00	18-5113	64E-43880-00-00	18-6783	66M-W0001-20-00	18-74513	682-41112-A1	18-99096
61N-85570-10-00	18-5113	64E-43880-01-00	18-6783	66M-W0093-00-00	18-7738	682-41133-A0	18-99021
61N-W0078-11-00	18-3432	64J-41133-10	18-99008	66M-W0093-01-00	18-7738	682-44315-A0-00	18-0768
61N-W0093-00-00	18-7737	64X-81800-00-00	18-6862	66T-11181-A0-00	18-60522	682-44352-01-00	18-3074
61T-11193-A1	18-99057	64X-81800-00-00	18-6906	66T-11193-A0-00	18-60520	682-44365-00	18-1834
626-14390-90	18-7079	650-11651-04-00	18-1755	66T-14301-00-00	18-34605	682-44366-00	18-1831

YAMAHA cont.		YAMAHA cont.		YAMAHA cont.		YAMAHA cont.	
682-44367-00	18-1832	68F-41114-00	18-99101	69M-11196-A0-00	18-60521	6E5-81800-11-00	18-6413
682-45113-A1	18-99022	68F-45113-00	18-99102	69M-12411-01-00	18-3624	6E5-81800-12-00	18-6413
682-82556-00-00	MP28860	68F-81800-01-00	18-6426	69M-14301-11-00	18-34604	6E5-81840-10-00	18-56005
682-W0001-06	18-99097	68F-8592A-00-00	18-7656	69W-43880-00-00	18-6811	6E5-81941-10-00	18-5853
682-W0078-A1-00	18-3148	68F-W0001-01	18-99103	69W-81800-00-00	18-6942	6E5-81941-11-00	18-5853
682-W0078-A1-00	18-3411	68F-W1135-00-00	18-64415	6A0-24410-00-00	18-7334	6E5-85540-10-00	18-5135
683-45315-A0	18-99152	68T-13475-00	18-99027	6A0-24410-01-00	18-7334	6E5-85540-11-00	18-5135
683-W0001-C1-00	18-74501	68T-24251-00-00	18-77107	6A0-24410-02-00	18-7334	6E5-85540-12-00	18-5135
688-11181-02-00	18-3805	68T-44323-00-00	18-3142	6A0-24410-03-00	18-7334	6E5-85570-11-00	18-5110
688-11181-A1-00	18-3805	68T-44352-00-00	18-8910	6A0-24410-04-00	18-7334	6E5-W0001-51-00	18-2794-1
688-11193-01-00	18-0767	68T-44366-00-00	18-3176	6A0-24410-05-00	18-7334	6E5-W0001-F1-00	18-2794-1
688-11603-A0-00	18-3969	68T-W0001-20-00	18-74544	6A0-W0001-21	18-99104	6E5-W0078-01-00	18-3372
688-11650-03-00	18-1756	68T-W0078-00-00	18-3410	6A1-44325-00-00	18-1079	6E5-W0078-A1-00	18-3373
688-12414-A1-00	18-0844	68T-W0078-00-00	18-3450	6A1-W0001-22-00	18-0026	6E5-W0093-06-00	18-7002
688-13621-A1	18-99098	68V-11325-01-00	18-6118A	6A1-W0001-23-00	18-0027	6E7-11181-00-00	18-3828
688-41112-A0-00	18-0847	68V-13766-00-00	18-2083	6A1-W0078-01-00	18-3463	6E7-11181-A1-00	18-3828
688-41114-A0	18-99148	68V-13907-00-00	18-7340	6A1-W0078-02-00	18-3462	6E7-11631-00-97	18-4135
688-41133-00	18-99023	68V-13907-01-00	18-7340	6A1-W0093-01-00	18-7293	6E7-11635-00-00	18-4136
688-41134-A0	18-99024	68V-13907-02-00	18-7340	6AW-14984-00	18-0714	6E7-14227-00	18-99144
688-43880-11-00	18-6821	68V-13907-03-00	18-7340	6AW-24502-00-00	18-79984	6E7-14385-00-00	18-7393
688-44311-01-00	18-3171	68V-13915-00-00	18-79903	6AW-24502-10	18-79984	6E7-14390-12-00	18-7073
688-44315-A0-00	18-0239	68V14984-00	18-0710	6AW-44352-00-00	18-8925	6E7-85570-10-00	18-5112
688-44316-A0-00	18-0240	68V-15312-00	18-99028	6BG-13915-00	18-79970	6E7-85570-19-00	18-5112
688-44352-03-00	18-3070	68V-24502-00-00	18-79986	6BX-G4315-01-00	18-60541	6E7-W0093-04-00	18-7769
688-45113-A0	18-99151	68V-24502-01-00	18-79986	6C5-13915-00	18-79973	6E8-14380-12-00	18-7073
688-45114-A1	18-99025	68V-24502-02	18-79986	6C5-14984-00	18-0717	6E9-11193-A0	18-99106
688-45123-00	18-99026	68V-24502-20-00	18-79985	6C5-24251-00	18-79983	6E9-12414-A1	18-99142
688-45331-00-94	18-2782	68V-24502-30	18-79985	6C5-43880-00-00	18-6836	6E9-41114-A0	18-99107
688-45341-00-00	18-2374	68V-24563-00-00	18-7979	6CB-13016-00	18-0707	6E9-82575-02-00	18-65450
688-45341-00-00	18-23741-9	68V-44323-00-00	18-3521	6CB-13915-00	18-79978	6E9-W0093-02-00	18-7740
688-45341-10-00	18-2374	68V-45123-00-00	18-0618	6CB-14984-00	18-0716	6E9-W0093-03-00	18-7741
688-45341-10-00	18-23741-9	68V-81800-01-00	18-6427	6CB-24501-00	18-79979	6F3-W0001-04-00	18-4403
688-45371-02-00	18-6070	68V-W0001-20-00	18-74515	6CB-81800-00-00	18-6961	6F3-W0001-21-00	18-2794-1
688-45371-02-00	18-6111	68V-W0078-00	18-3523	6CE-12411-00-00	18-3524	6F3-W0001-A4-00	18-4403
688-45611-00-00	18-2388	68V-W0078-00	18-3523-1	6CE-44352-00-00	18-45617	6F3-W0001-C1-00	18-2794-1
688-45997-01-00	18-4274	68V-W0078-00-00	18-3442	6D3-81800-00-00	18-6907	6F5-12411-03-00	18-3625
688-81800-12-00	18-6423	692-14590-00-00	18-7060	6D8-WS24A-00-00	18-79799	6F5-24563-00-00	18-7780
688-81941-00-00	18-5879	692-14590-01-00	18-7060	6E0-24411-00-00	18-7389	6F5-44352-00-00	18-3088
688-81950-10-00	18-5879	692-24410-00-00	18-7334	6E0-24471-00-00	18-7834	6F5-81800-11	18-6421
688-85540-16-00	18-5130	692-24411-00-00	18-7391	6E0-44352-00-00	18-3073	6F5-85540-21-00	18-5136
688-W0001-00-00	18-4415	692-W0078-00-00	18-3370	6E0-44366-00-00	18-3166	6F5-85540-22-00	18-5136
688-W0001-20-00	18-2798	692-W0078-01-00	18-3370	6E0-W0001-C1-00	18-0028	6F5-W0078-00-00	18-3374
688-W0001-22-00	18-0021	692-W0078-A0-00	18-3370	6E5-11181-02-00	18-3832	6F5-W0078-00-00	18-3398
688-W0001-A0-00	18-4415	692-W0078-A0-00	18-3371	6E5-11181-A1-00	18-3832	6F5-W0078-A0-00	18-3374
688-W0001-C0-00	18-2798	695-11181-A0-00	18-3849	6E5-11193-A0-00	18-0781	6F5-W0078-A0-00	18-3398
689-11181-02-00	18-3804	695-11181-A1-00	18-3849	6E5-11381-A1-00	18-0782	6G1-11193-A1	18-99108
689-11631-00-95	18-4138	695-85540-12-00	18-5131	6E5-11610-03-00	18-3934	6G1-13621-A1	18-99109
689-44352-02-00	18-3067	695-85570-10-00	18-5112	6E5-11610-23-00	18-3936	6G1-13645-A1	18-99110
689-45113-A1-00	18-0739	695-W0001-01-00	18-4417	6E5-12411-02-00	18-3623	6G1-14198-A1	18-99111
689-5755-01-00	18-50000	695-W0001-02-00	18-4417	6E5-12411-30-00	18-3540	6G1-14546-00-00	18-7054
689-81311-40-00	18-5137	695-W0001-A2-00	18-4417	6E5-13411-00	18-79975	6G1-14546-01-00	18-7054
689-81311-40-00	18-5195	696-W0093-02-00	18-7290	6E5-13621-A1	18-99105	6G1-14985-00-00	18-7067
689-81800-11	18-6410	697-11181-A0-00	18-3848	6E5-13645-A1-00	18-0823	6G1-15755-00-00	18-50001
689-81800-12	18-6410	697-11181-A1-00	18-3848	6E5-14198-A1-00	18-0785	6G1-15779-00-00	18-50000
689-81800-13-00	18-6410	697-44352-00-00	18-3069	6E5-14384-02-00	18-0786	6G1-15779-00-00	18-50001
689-81840-11-00	18-56002	697-45114-A0	18-99030	6E5-14384-03-00	18-2592	6G1-24305-04	18-80414
689-W0001-21-00	18-2785	697-81800-12	18-6412	6E5-14385-00-00	18-7068	6G1-24305-05-00	18-80414
689-W0001-23-00	18-0022	697-85570-11-00	18-5111	6E5-14385-01-00	18-7068	6G1-24411-00-00	18-7388
689-W0001-A1-00	18-3804	697-W0001-00-00	18-4418	6E5-14385-02-00	18-7069	6G1-24431-01	18-99147
689-W0001-C1-00	18-2785	697-W0001-A0-00	18-4418	6E5-14546-00-00	18-7055	6G1-24471-00-00	18-7833
689-W0001-C2-00	18-0023	698-W0001-20-00	18-2787	6E5-24305-05	18-80415	6G1-41112-A1	18-99112
689-W0078-04-00	18-3426	698-W0001-21-00	18-0024	6E5-24410-00-00	18-7349	6G1-41114-A0	18-99113
689-W0078-A4-00	18-3426	698-W0001-C0-00	18-2787	6E5-24410-01-00	18-7349	6G1-41133-A0	18-99114
689-W0078-A6-00	18-3427	69G-W0001-20-00	18-0025	6E5-24410-02-00	18-7349	6G1-44315-A0-00	18-0753
689-W0093-02-00	18-7770	69J-13440-00-00	18-7906-1	6E5-24410-03-00	18-7349	6G1-44322-00-00	18-3456
68D-11351-A0-00	18-60518	69J-13440-01-00	18-7906-1	6E5-24410-04-00	18-7349	6G1-44352-00-00	18-3066
68D-E1169-A0-00	18-60512	69J-24501-00	18-79981	6E5-24410-10-00	18-7349	6G1-45113-A1	18-99115
68D-E1193-A0-00	18-60519	69J-24501-10-00	18-79905	6E5-24411-00-00	18-7843	6G1-45315-A0	18-99116
68D-E2414-A0-00	18-0754	69J-24502-00	18-79982	6E5-24471-00-00	18-7842	6G1-81941-10-00	18-5821
68D-G4311-01-00	18-43263	69J-41134-A0	18-99032	6E5-41112-A1-00	18-0799	6G1-W0001-A2	18-99117
68D-G5987-00-00	18-73891	69J-41135-A0	18-99033	6E5-41134-A0	18-99037	6G1-W0001-C1-00	18-0029
68D-WG078-00-00	18-48619	69J-41136-A0	18-99034	6E5-41135-A0	18-99038	6G1-W0078-01-00	18-3460
68F-11181-00	18-99062	69J-41138-00-00	18-0619	6E5-43880-01-00	18-6821	6G1-W0078-A1-00	18-3460
68F-11193-01	18-99099	69J-43880-00-00	18-6798	6E5-43880-02-00	18-6821	6G1-W0093-00-00	18-7765
68F-11381-00	18-99100	69J-45123-00-00	18-0656	6E5-44311-00-00	18-3170	6G5-11181-00-00	18-3894
68F-13440-00	18-79971	69J-81800-00-00	18-6833	6E5-44315-A0-00	18-0244	6G5-11181-A0-00	18-3894
68F-13907-00-00	18-7342	69L-45371-00-00	18-6122A	6E5-44323-00-00	18-3344	6G5-11193-A0-00	18-0779
68F-13907-01-00	18-7342	69L-45371-00-00	18-6122Z	6E5-44352-00-00	18-3071	6G5-11382-A1-00	18-0808
68F-13915-00-00	18-79904	69L-81800-00-00	18-6861	6E5-44352-01-00	18-3071	6G5-11631-00-93	18-4129
68F-24563-00	18-79980	69L-81800-00-00	18-6861	6E5-45371-01-00	18-6097	6G5-11636-00-00	18-4133
68F-24563-10-00	18-7955	69M-11181-00-00	18-60523	6E5-45611-01-00	18-2385	6G5-11642-00-93	18-4128

*Para localizar el número de página, consulte el índice / referencia de la página 750 a 781

YAMAHA cont.		YAMAHA cont.		YAMAHA cont.		YAMAHA cont.	
6G5-13645-A1-00	18-0809	6H4-11181-00-00	18-3830	6L5-45616-00-00	18-73892	93101-22M15-00	18-2079
6G5-14483-A1	18-99118	6H4-11181-A1-00	18-3830	6M6-81800-10-00	18-6862	93101-23070-00	18-0297
6G5-41112-A1-00	18-0812	6H4-11193-A1-00	18-0815	6M6-8183E00-00	18-15080	93101-25M03-00	18-0587
6G5-41134-A1	18-99039	6H4-11610-00-00	18-3960	6M6-81960-A0-00	18-6650	93101-28M16-00	18-0265
6G5-43864-00-00	18-7468	6H4-11610-10-00	18-3961	6N0-W0001-C0-00	18-0031	93101-30M17-00	18-0266
6G5-43880-02-00	18-6760	6H4-11610-20-00	18-3962	6N0-W0078-A0-00	18-3460	93102-23096-00	18-0570
6G5-44323-00-00	18-3345	6H4-11631-00-96	18-4141	6N6-W0001-03-00	18-4411	93102-25M28-00	18-0588
6G5-45113-A0-00	18-0813	6H4-11635-01-00	18-4142	6N6-W0001-A3-00	18-4411	93102-35M13-00	18-2085
6G5-45114-A1	18-99040	6H4-11636-00-00	18-4143	6N6-W0078-00-00	18-3312	93102-40M36-00	18-2087
6G5-45251-01-00	18-6090	6H4-13621-A1	18-99132	6N6-W0078-01-00	18-3313	93102-40M38-00	18-2088
6G5-W0001-03-00	18-4404	6H4-14198-01	18-99133	6N6-W0078-01-00	18-3313-1	93104-22M07-00	18-2091
6G5-W0001-21-00	18-2794-1	6H4-15369-A1	18-99134	6N6-W0093-02-00	18-7744	93106-09014-00	18-0267
6G5-W0001-A3-00	18-4404	6H4-41112-A0	18-99135	6N7-81800-10-00	18-6415	93210-19123-00	18-7463
6G5-W0001-C1-00	18-2794-1	6H4-41114-A0-00	18-0798	6N7-81840-00-00	18-56006	93210-24M79	18-76694
6G5-W0078-01-00	18-3310	6H4-44352-00-00	18-3068	6OV-13646-00	18-99139	93210-27ME3-00	18-76691
6G5-W0078-A1-00	18-3311	6H4-44352-02-00	18-3068	6P2-14984-00	18-0713	93210-31MJ5-00	18-76693
6G5-W0093-08-00	18-7747	6H4-81800-12-00	18-6422	6P2-44323-00-00	18-3518	93210-32738-00	18-7432
6G5-W4599-00-00	18-3782	6H4-W0001-01-00	18-4407	6P2-W0078-00-00	18-3515	93210-33M85-00	18-7119
6G8-11181-00-00	18-3827	6H4-W0001-02-00	18-4419	6P3-24564-00-00	18-7488	93210-37M67-00	18-7483
6G8-11181-A1-00	18-3827	6H4-W0001-03-00	18-4409	6P3-W5624-00-00	18-79809	93210-41042-00	18-0298
6G8-11351-A0	18-99119	6H4-W0001-04-00	18-4409	6R3-85570-01-00	18-5128	93210-46044-00	18-7436
6G8-12414-A0	18-99120	6H4-W0001-20-00	18-2792	6R3-W0001-03-00	18-4412	93210-46M16-00	18-76690
6G8-13440-00-00	18-7901	6H4-W0001-21-00	18-2792	6R3-W0001-A3-00	18-4412	93210-54M54-00	18-7439-9
6G8-13646-A0	18-99121	6H4-W0001-A1-00	18-4407	6R5-11603-00	18-39320	93210-66M98-00	18-0299
6G8-14198-A0	18-99122	6H4-W0001-A2-00	18-4419	6R5-11631-11-93	18-4081	93210-74M35-00	18-7442
6G8-15374-00	18-99123	6H4-W0078-00	18-3408	6R5-11635-11-00	18-4083	93210-75M51-00	18-76692
6G8-45113-A1	18-99045	6H4-W0078-00-00	18-3429	6R5-11636-11-00	18-4085	93210-86M38-00	18-7485
6G9-W0001-C4-00	18-74526	6H4-W0078-A0	18-3408	6R5-11642-11-93	18-4080	93210-97M55-00	18-0275
6G9-W0001-C6-00	18-74527	6H4-W0078-A0-00	18-3429	6R5-11645-11-00	18-4082	93211-04384-00	18-7444
6H0-W0093-00-00	18-7742	6H4-W0093-01-00	18-7767	6R5-11646-11-00	18-4084	93310-32337-00	18-1410
6H1-11631-03-95	18-4097	6H4-W0093-03-00	18-7768	6R5-11650-10-00	18-4157	93310-620V5-00	18-1411
6H1-11636-03-00	18-4099	6H4-W4599-00-00	18-73990	6R6-W0001-01-00	18-4413	93310-730V8-00	18-4077
6H1-13411-00	18-79961	6H5-43880-02-00	18-6788	6S5-81800-00-00	18-6909	93310-836V2-00	18-4078
6H1-43880-00-00	18-6259	6J4-81800-01-00	18-6421	6Y1-24305-04	18-80413	93604-18080-00	18-43716
6H1-43880-02-00	18-6781	6J8-11181-00-00	18-3829	6Y2-24305-05	18-80415	95307-16900-00	18-3732
6H1-45251-02-00	18-6091	6J8-11181-A1-00	18-3829	6YL-24306-60-00	18-8017EP-1	97080-08045-00	18-0256
6H1-W0001-00-00	18-4405	6J8-12414-A0-00	18-0829	6YL-24306-60-00	18-8017S	97095-06040-00	18-2607
6H1-W0001-01-00	18-4405	6J8-13411-00	18-79974	703-82510-12-00	MP51020	97095-08045-00	18-0256
6H1-W0001-A0-00	18-4405	6J8-14546-00-00	18-7055	703-82510-12-00	MP51022	99999-03249-00	18-6412
6H1-W0093-01-00	18-7291	6J8-24471-00-00	18-7841	703-82510-43-00	MP51040	ABA-FBARB-90-DG	18-8040
6H1-W4599-00-00	18-3781	6J8-81960-00-00	18-17301	703-82510-43-00	MP51042	ABA-FLINE-BA-RB	18-8055
6H2-14591-00-00	18-7056	6J8-W0001-21-00	18-2789	90105-10M00-00	18-6246	ABB-FUELF-IL-TR	18-7845
6H2-81960-00-00	18-6858	6J8-W0001-C2-00	18-2789	90119-08M13-00	18-2606	ABB-FUELF-IL-TR	18-7945
6H3-11181-01-00	18-3831	6J8-W0078-A1-00	18-3430	90119-08M15-00	18-8400-9	ABB-SPRTR-HD-SS	18-7777-1
6H3-11181-A1-00	18-3831	6J9-45371-01-00	18-6035	90119-08M87-00	18-2605	LUB-20W40-FC-12	18-9450-2
6H3-11193-A1	18-99141	6J9-45371-01-00	18-6112	90171-10M01	18-3773	LUB-2STRK-M1-4	18-9530-3
6H3-11631-01-96	18-4091	6K1-45371-00-00	18-6034	90171-14056-00	18-3792	LUB-2STRK-M1-55	18-9530-7
6H3-11636-01-00	18-4093	6K1-45371-00-00	18-6034A	90171-14056-00	18-73907	LUB-MRNLG-KT-10	18-9393
6H3-12411-11-00	18-3622	6K1-45371-02-00	18-6121A	90171-16011-00	18-3732	LUB-MRNMMD-KT-10	18-9391
6H3-12414-A1	18-99124	6K1-45371-02-00	18-6121Z	90201-08M54-00	18-73978	LUB-MRNMMD-KT-10	18-9392
6H3-13621-A1	18-99143	6K1-82510-06-00	MP51050	90201-22M01	18-9078	LUB-MRNSM-KT-10	18-9390
6H3-13622-00	18-99125	6K1-82510-06-00	MP51052	90206-22M19	18-9077	MAR-10171-00-10	18-7924
6H3-14198-01	18-99126	6K5-11601-02-00	18-3963	90280-03003-00	18-3305	MAR-10171-30-00	18-7606
6H3-14590-00-00	18-7056	6K5-11636-03-00	18-4096	90280-03024-00	18-3305	MAR-24563-00-00	18-7919
6H3-14590-01-00	18-7056	6K7-13645-A1-00	18-0807-1	90280-03M03-00	18-3297	MAR-FLTHD-AL-12	18-7853-1
6H3-41112-A0	18-99128	6K7-13686-A1	18-99136	90280-04M00-00	18-3300	MAR-FLTHD-SS-12	18-7777
6H3-41114-A0	18-99129	6K7-W0093-09-00	18-7759	90280-04M04-00	18-3301	MAR-FUELF-IL-TR	18-7866
6H3-44311-00	18-3466	6K8-81960-A0-00	18-6652	90280-04M05-00	18-3302	MAR-MINIF-IL-TR	18-7865
6H3-44315-A0-00	18-0756-1	6L2-11181-A1-00	18-3847	90340-08002-00	18-2371	MAR-MINIF-LT-AS	18-7965-1
6H3-44324-A0-00	18-0757	6L2-11181-A2-00	18-3847	90340-08002-00	18-23711-9	MAR-SEPAR-AT-OR	18-7852-1
6H3-44352-00-00	18-3069	6L2-14384-00-00	18-0765	90340-08M04-00	18-2371	MAR-SEPAR-AT-OR	18-7966-1
6H3-45113-A0	18-99130	6L2-14385-00-00	18-7063	90340-08M04-00	18-23711-9	MAR-SPRTR-HD-SS	18-7984-1
6H3-45114-A1	18-99046	6L2-14392-00-00	18-7049	90430-08020-00	18-4698	N26-13440-00-00	18-7954
6H3-45123-00	18-99047	6L2-14392-00-00	18-7058	90430-08020-00	18-46981-9	YB-6AW04-1	18-9133-9
6H3-81800-10	18-6411	6L2-41112-A1-00	18-0743	90430-14115-00	18-0826	YB-6AW04-3	18-9146-9
6H3-81800-11-00	18-6411	6L2-41114-A1-00	18-0744	90430-14228-00	18-0755	YB-6AW04-A	18-9145
6H3-85510-A1	18-5746	6L2-41133-A2	18-99137	904-30142-28-00	18-0755	YB-ACC04	18-79815
6H3-W0001-02	18-99176	6L2-44352-00-00	18-3065	90430-14M09-00	18-0755	YSC-10231-20-0C	18-7824-1
6H3-W0001-21-00	18-2788	6L2-45315-A0	18-99138	90790-74001-00	22423	YSC-10260-00-0C	18-15111
6H3-W0001-22-00	18-74504	6L2-45987-01-00	18-73979	91401-30028-00	18-2380	YSC-10260-10-0C	18-15110
6H3-W0001-A0-00	18-4427	6L2-81800-20-00	18-6420	91401-30030-00	18-2380	YSC-12190-00-AC	18-2909
6H3-W0001-C1-00	18-2788	6L2-W0001-01-00	18-4422	91402-30022-00	18-2380	YSC-13080-00-0C	18-0164
6H3-W0078-00-00	18-3428-1	6L2-W0001-02-00	18-4422	91402-30022-09	18-2380	YSC-13231-20-0C	18-7824-1
6H3-W0078-00-00	18-3461	6L2-W0001-A2-00	18-4422	91402-30028-00	18-2380	YSC-13260-60-0C	18-15106
6H3-W0078-01	18-3466	6L2-W0001-C3-00	18-0030	91402-30028-09	18-2380	YSC-13260-70-0C	18-15107
6H3-W0078-01-00	18-3464	6L2-W0078-00-00	18-3431	91490-25030-00	18-73893	YSC-14231-20-0C	18-7876
6H3-W0078-02-00	18-3465	6L2-W0093-00-00	18-7739	91490-30030-00	18-2380	YSC-16231-20-0C	18-7875
6H3-W0078-02-00	18-3466	6L5-24251-00	18-79977	91490-30045-00	18-3748	YSC-22260-00-0C	18-15109
6H3-W0078-A0-00	18-3428-1	6L5-44322-00-00	18-3164	91490-40030-00	18-3735	YSC-22260-10-0C	18-15108
6H3-W0078-A0-00	18-3461	6L5-44323-00-00	18-3163	93101-20M07-00	18-0554	YSG-10108-43-8G	18-0876
6H3-W0093-02-00	18-7766	6L5-44352-00-00	18-8911	93101-22067-00	18-0296	YSG-10108-44-5G	18-0874

YAMAHA cont.		YANMAR cont.	
YSG-10114-14-1G	18-0889	18-55501	18-55501
YSG-14090-90-8G	18-0905	192470-42530	18-3277
YSG-14096-15-6G	18-0887	192470-42532	18-3277
YSG-37545-87-G0	18-0891	27210-200200	18-6200
YSG-38600-39-G0	18-0903	27210-200300	18-6201
YANMAR		424610-77010	18-6934
		728170-92600	18-55500
104211-42070	18-3079	728271-92605	18-55502
104211-42071	18-8952	728374-92605	18-55503
104211-49160	18-56601		
104211-77010	18-6930		
104211-77011	18-6930		
104500-55710	18-79960		
114361-77011	18-6936		
114362-77010	18-6936		
114362-77011	18-6936		
114399-77010	18-6936		
119209-77010	18-6931		
119225-77010	18-6935		
119225-77011	18-6935		
119226-77010	18-6935		
119350-35150	18-7910-1		
119350-35151	18-7910-1		
119573-77200	18-6927		
119573-77200	18-6929		
119573-77201	18-6927		
119573-77201	18-6929		
119574-42550	18-45714		
119574-42552	18-45714		
119773-42600-00	18-3306		
119773-77010	18-6938		
119773-77200	18-6849		
119836-77200	18-6926		
119836-77200-2	18-6926		
119836-77200-3	18-6926		
121120-77010	18-6931		
121120-77011	18-6931		
121120-77012	18-6931		
121254-77010	18-6939		
121254-77011	18-6939		
121254-77012	18-6939		
121254-77019	18-6939		
121370-77010	18-6932		
123500-77010	18-6934		
124085-35113	18-7917		
124223-42092	18-8950		
124450-35100	18-7910-1		
124450-35110	18-7917		
124520-77010	18-6931		
124520-77011	18-6931		
124550-35110	18-7917		
124610-77010	18-6934		
124610-77019	18-6934		
127610-42200	18-3077		
128170-01331	18-55600		
128170-11310	18-56000		
128170-42090	18-56602		
128170-77010	18-6937		
128170-77010D	18-6937		
128170-77200	18-6928		
128170-77201	18-6928		
128170-77202	18-6928		
128171-01911	18-55601		
128171-12540	18-57704		
128176-42071	18-8951		
128270-12540	18-57703		
128270-77200	18-6925		
128271-01911	18-55602		
128374-01911	18-55603		
129242-77010	18-6932		
129429-77010	18-6939		
129429-77011	18-6939		
129470-77200	18-6927		
129470-77200	18-6970		
129573-77010	18-6880		
129612-77230	18-6926		
129698-77010	18-6932		
171008-77010	18-6880		
171056-35110	18-7917		
171056-35111	18-7917		

*Para localizar el número de página, consulte el índice / referencia de la página 750 a 781

ÍNDICE REFERENCIAS / NÚMERO DE PÁGINA

Código	Páginas	Código	Páginas	Código	Páginas	Código	Páginas
005053	245	017021	697	050803	699	050843	245-262-699
009318	116-611	017022	697	050804	262-336-336-699	050845	338-699
009319	116	017023	697	050805	699	050846	236-699
009320	537	025298	537	050806	262-336-699	050847	699
009321	536	025300	536	050807	262-336-337-699	050848	699
009322	116	025304	317	050808	699	050849	699
009346	678	025339	116-610	050809	262-263-336-337-699	050850	699
009347	678	025756	116	050810	245-246-262-263-264-336-337-699	050851	699
009350	678	025757	116	050811	699	050852	699
009351	678	025840	611-678	050812	699	050853	262-336-337-699
009352	678	025841	317	050813	699	050854	237-263-264-338-699
009353	536	0025845	537	050814	699	050855	262-699
009354	24-536	025848	217	050815	699	050856	699
009355	317	025849	536	050816	699	050857	681-682-683-699
009357	317	025851	678	050817	699	050858	699
009365	536	050606	681	050818	699	050859	246-699
009366	610	050608	681	050819	681-699	050860	699
009368	116-610	050700	681-682-699	050820	262-699	050861	699
009369	537	050701	699	050821	681-699	050862	235-236-338-699
009371	536	050702	699	050822	681-699	050863	699
009372	537	050703	235	050823	699	050864	699
009464	24-537	050705	699	050824	699	050865	235-699
016734	697	050706	699	050825	699	050866	699
016735	697	050707	699	050826	264-699	050867	699
016736	697	050708	682-683-699	050827	245-262-699	050868	699
016737	697	050709	681-699	050828	699	050869	699
016738	697	050710	699	050829	245-699	050870	235-236-237-699
016739	697	050711	699	050830	262-699	050871	235-236-699
016740	697	050712	699	050831	681-682-683-699	050872	699
016741	697	050714	262	050832	262-336-338-699	050873	699
016742	697	050722	236-237	050833	699	050874	245-262-699
016743	697	050723	245-246	050834	699	050875	699
016744	697	050724	246	050835	263-264-337-338-699	050876	236-699
016745	697	050732	262	050836	699	050877	681-682-683-699
016750	697	050735	237	050837	337-338-699	050878	682-683-699
017001	697	050736	236	050838	236-237-699	050879	682-699
017002	697	050738	264	050839	235-236-699	050880	262-336-338-699
017003	697	050800	699	050840	235-236-699	050881	338-699
017004	697	050801	699	050841	699	050882	699
017020	697	050802	336-699	050842	236-699	050883	338-699

Código	Páginas	Código	Páginas	Código	Páginas	Código	Páginas
050884	699	050933	698	050979	681-698	112325	690-693
050885	699	050934	698	050980	681-682-698	112326	691
050886	236-245-246-699	050935	698	050981	698	112327	690-691
050887	699	050936	698	050982	698	112328	690-691
050888	699	050937	245-335-698	050984	335	112329	690-692
050889	699	050938	261-698	050985	245	112330	690-692
050890	699	050939	698	051012	335	112331	691
050891	699	050940	698	051013	335	112350	688-689
050892	262-336-699	050941	698	051014	335	112351	688
050894	235-699	050942	698	051015	335	112352	688-689
050895	699	050943	261-698	51028	335	112355	688
050896	338-699	050944	698	051028	683	112356	688
050899	699	050945	698	051029	683	112357	688
050901	698	050946	682-698	56507	54	112358	688
050902	698	050947	698	101265	684	112359	688
050903	698	050948	261-681-698	101267	684	112360	689
050904	698	050949	682-683-698	101268	684	112361	688
050905	698	050950	698	101269	684	112362	689
050906	335-698	050951	698	101272	684	112363	688
050907	245-261-335-698	050952	681-698	101273	684	112364	688
050908	698	050953	698	101275	684	112365	688
050909	245-261-698	050954	698	101276	684	112370	688
050910	245-261-335-698	050955	683-698	112301	690-691	112397	696
050911	698	050956	698	112302	690-691	112400	696
050912	698	050957	245-261-335-698	112303	690-691	112401	696
050913	698	050958	698	112305	690-691	112402	696
050914	335-698	050959	698	112306	690-691	112403	696
050915	261-335-698	050960	698	112307	690-691	112404	696
050916	698	050961	698	112308	690-691	112405	696
050917	698	050962	698	112309	690-691	112406	696
050918	261-698	050963	698	112310	690-692	112413	687
050919	261-335-698	050964	683-698	112311	690-692	136000	687
050920	261-698	050965	698	112312	690-692	136001	687
050921	698	050966	335-698	112313	690-692	136002	687
050922	698	050967	698	112314	692	136003	687
050923	698	050969	698	112315	690-692	136004	687
050924	681-698	050970	698	112316	690-692	136005	687
050925	681-698	050971	698	112317	690-692	136014	687
050926	698	050972	698	112318	690-693	136015	687
050927	698	050973	698	112319	693	136016	687
050928	681-682-683-683-698	050974	698	112320	690-693	136017	687
050929	698	050975	698	112321	690-693	136018	687
050930	698	050976	698	112322	690-693	136019	687
050931	698	050977	698	112323	690-692	136020	687
050932	698	050978	683-698	112324	690-692	136021	687

Código	Páginas	Código	Páginas	Código	Páginas	Código	Páginas
136022	687	149061	713	189650	686	1360211	687
136023	687	149062	713	189652	686	1360221	687
136024	687	149065	713	189655	686	1360231	687
136083	687	188004	689	189750	685	1360241	687
136084	687	188009	689	189781	687	1360831	687
136116	687	188010	689	189788	687	1360841	687
149000	713	188013	689	290000	11	1361161	687
149001	713	188017	689	290001	11	1880400	695
149007	713	188018	689	290002	11	1880401	695
149008	713	188020	689	290003	12	1880402	695
149009	713	188021	689	290004	12	1880403	695
149010	713	188027	689	290005	12	1880404	695
149011	713	188056	693	290006	12	1880405	695
149012	713	188062	694	290007	12	1880408	695
149013	713	188063	693	290008	12	1880409	694
149014	713	188067	693	290009	12	1894102	687
149015	713	188068	694	290010	12	1894104	687
149016	713	188069	695	290011	11	1894402	685
149017	713	188070	694	290012	12	1894404	685
149018	713	188071	694	290013	13	1895402	685
149019	713	188075	695	290014	13	1895403	685
149020	713	188076	695	290015	13	1895503	684
149021	713	188077	694	290016	13	1895512	686
149022	713	188078	694	290017	12	1895513	686
149023	713	188079	694	508516	696	1895516	686
149024	713	188082	694	508517	696	1895517	686
149025	713	188084	694	508518	696	1895523	686
149026	713	188085	695	508519	696	1895526	686
149028	713	188087	694	704013	710	1895528	686
149029	713	188088	693	826423	653	1895532	685
149030	713	188089	694	838513	653	1895533	685
149031	713	188090	694	845792	653	1895535	685
149032	713	188092	693	856306	653	1895536	685
149034	713	189200	684	1360001	687	1895537	685
149035	713	189402	685	1360011	687	1896802	687
149037	713	189404	685	1360021	687	1896805	687
149049	713	189422	685	1360031	687	1896902	685
149050	713	189423	685	1360041	687	1896903	685
149051	713	189443	686	1360051	687	02456900	684
149053	713	189448	686	1360061	687	6924270	710
149054	713	189502	685	1360071	687	6924271	710
149055	713	189503	685	1360081	687	6924272	710
149057	713	189600	686	1360091	687	6924273	710
149058	713	189602	686	1360151	687	6924275	710
149059	713	189605	686	1360201	687	6924276	710

Código	Páginas	Código	Páginas	Código	Páginas	Código	Páginas
6924277	710	18-0120	86	18-0183-1	471-493-583-593-671	18-0296	222-334
6924279	710	18-0122	85	18-0184	676	18-0297	222-334
6924280	710	18-0122-9	85	18-0185	495	18-0298	225-334
6924283	710	18-0124	89	18-0185-9	495	18-0299	225-334
6924284	710	18-0124-9	89	18-0188	595	18-0300	23
62490137813	702	18-0126	86	18-0188-9	595	18-0307	672
16-337-0380	52	18-0126-9	86	18-0190	594	18-0310	672
16-337-0560	52	18-0128	87	18-0191	301	18-0311	494-593-672
18-0020	330	18-0129	194	18-0192	301	18-0313	89
18-0021	330	18-0130	85	18-0195	105-605	18-0318	497
18-0022	330	18-0130-9	85	18-0197	105	18-0319	196
18-0023	330	18-0131	194	18-0198	105-605	18-0320	194
18-0024	330	18-0133	194	18-0200	105	18-0322	496-594-674
18-0025	330	18-0134	84	18-0201	105	18-0322-9	496-594-674
18-0026	331	18-0134-9	84	18-0202	214	18-0323	197
18-0027	331	18-0135	196	18-0203	497	18-0324	193
18-0028	331	18-0136	87	18-0203-9	497	18-0327	495-593-672
18-0029	331	18-0137	194	18-02060	598	18-0328	494
18-0030	331	18-0138	87	18-02061	598	18-0328-9	494
18-0031	331	18-0139	196	18-02062	598	18-0329	495-594
18-0032	374-664	18-0140	85	18-02063	598	18-0333	196
18-0033	374-664	18-0142	85	18-02065	598	18-0334	196
18-0034	374-664	18-0144	85	18-02066	598	18-0336	196
18-0035	374-664	18-0144-9	85	18-02067	598	18-0337	658
18-0036	374-664	18-0146	658	18-0207	598	18-0339	197
18-0101	193	18-0147	495-593-673	18-0209	598	18-0340	489-589
18-0102	86	18-0148	85	18-0211	598	18-0341	196
18-0103	196	18-0151	195	18-0227	598	18-0342	496
18-0104	592	18-0153	489-589	18-0229	598	18-0345	198
18-0104-9	592	18-0155	89	18-0232	195-314	18-0346	494-593
18-0105	194	18-0155-9	89	18-0239	314	18-0347	494-593-672
18-0106	86	18-0157	85	18-0240	315	18-0348	489-589
18-0106-9	86	18-0158	493	18-0244	315	18-0352	494-593-672
18-0107	194	18-0159	85	18-0248	23	18-0353	471-491
18-0108	89	18-0161	85	18-0250	314	18-0354	491
18-0108-9	89	18-0163	660	18-0252	668	18-0356	491
18-0110	89	18-0164	591-671	18-0256	289	18-0357	491
18-0110-9	89	18-0164-9	591-671	18-025844	258	18-0359	194
18-0111	493	18-0166	594	18-0265	334	18-0360	492
18-0112	87	18-0166-9	594	18-0266	334	18-0365	493
18-0113-1	493	18-0172	222-540	18-0267	222-334	18-0368	650
18-0114	583-592	18-0175	225-541	18-0275	334	18-0369	196
18-0117	86	18-0176	22	18-0292	197	18-0371	194
18-0118	84	18-0182	88-197	18-0294	197-315-315	18-0372	195
18-0118-9	84	18-0182-9	88-197	18-0294-9	197-315	18-0373	194

Código	Páginas	Código	Páginas	Código	Páginas	Código	Páginas
18-0376	660	18-0465	488-589	18-0558	680	18-0650	258
18-0377	660	18-0466	489-589	18-0559	615	18-0651	258
18-0378	196	18-0467	492	18-0560	222	18-0652	608
18-0382	23	18-0468	494-594-673	18-0563	199	18-0653	608
18-0384	193	18-0476-1	472-583-658	18-0564	222	18-0654	608
18-0385	196	18-0477-9	255	18-0568-9	200	18-0655	608
18-0386	495	18-0478	255	18-0569	260	18-0656	307
18-0388	496	18-0479	255	18-0570	334	18-0663	186-305
18-0389	493	18-0480	255	18-0577	517	18-0664	494-593-672
18-0390	23	18-0483	314	18-0578	485-540	18-0667	492
18-0396	23	18-0487	490	18-0579	222	18-0667-9	492
18-0397	88	18-0488	490	18-0580	222	18-0670	196
18-0398	492-671	18-0489	668	18-0581	222	18-0672	472-493
18-0398-9	492-671	18-0491	82	18-0583	25-222	18-0672-9	472-493
18-0401	592	18-0492	82	18-0584	222	18-0673	592
18-0403	486	18-0498	669	18-0585	222	18-0673-9	592
18-0404	486	18-0514	199	18-0586	222	18-0675	88
18-0405	489-589-672	18-0515	222-540	18-0587	334	18-0679	89
18-0406	307	18-0516	222-540	18-0590	660	18-0680	493-593-671
18-0407	490-589	18-0517	222-540	18-0595	222	18-0681	497
18-0410	490-589-669	18-0518	222-485-595-667	18-0603	472-486-584	18-0681-9	497
18-0411	490-589	18-0519	222-485-540-588-667	18-0604	472-486-584	18-0685	491
18-0412	88	18-0521	199	18-0605	307	18-0690	87
18-0412-9	88	18-0522	25-222-540	18-0606	660	18-0691	87
18-0418	471-493-593-671	18-0523	222-540	18-0611	490	18-0692	87
18-0426	88	18-0525	222-540	18-0612	477	18-0693	87
18-0430	592	18-0526	222-540	18-0613	477	18-0694	87
18-0431	592	18-0527	222-540	18-0614	477	18-0695	87
18-0434	591	18-0528	485-588-667	18-0615	477	18-0696	87
18-0435	591	18-0529	222-540	18-0616	477	18-0707	278
18-0437	84	18-0531	222-540	18-0617	307	18-0710	277
18-0440	593	18-0537	222-540	18-0618	307	18-0711	277
18-0440-9	593	18-0539	199	18-0619	307	18-0712	277
18-0441	88	18-0540	90	18-0622	198	18-0713	277
18-0441-9	88	18-0542	615	18-0626	84	18-0714	277
18-0445	89	18-0543	615	18-0633	193	18-0715	153-278
18-0445-9	89	18-0544	260	18-0641	193	18-0716	278
18-0446	89	18-0545	260	18-0642	195	18-0717	278
18-0459	255	18-0546	260	18-0643	196	18-0720	473
18-0460	255	18-0548	593	18-0644	194	18-0721	473
18-0461	255	18-0549	595-677	18-0645	194	18-0722	473
18-0462	492	18-0550	595	18-0646	194	18-0737	23
18-0463	492	18-0551	260	18-0647	608	18-0739	314
18-0464	494-593	18-0554	222-334	18-0648	660	18-0743	314
18-0464-9	494-593	18-0557	209	18-0649	196	18-0744	314

Código	Páginas	Código	Páginas	Código	Páginas	Código	Páginas
18-0753	314	18-0851-9	89	18-0922-9	195	18-0959-9	85
18-0754	314	18-0856	307	18-0923	595	18-0961	84
18-0755	307	18-0858	225-541	18-0923-9	595	18-0961-9	84
18-0756-1	315	18-0860	225-541	18-0926	195	18-0963	85
18-0757	316	18-0864	485	18-0927	86	18-0963-9	85
18-0761	255	18-0868	490-589-669	18-0928-1	493	18-0965	87
18-0765	313	18-0870	195	18-0928-9	493	18-0967	88
18-0767	314	18-0871	45	18-0929	88-591-671	18-0967-9	88
18-0768	316	18-0874	492-591-674	18-0929-9	88-591-671	18-0969	89
18-0768-9	316	18-0874-9	492-591-674	18-0932	195	18-0969-9	89
18-0775	313	18-0876	491-591-671	18-0933	85	18-0970	194
18-0775-9	313	18-0876-9	491-591-671	18-0934-1	197	18-0970-9	194
18-0778	255	18-0879	196	18-0935	85	18-0971	88
18-0779	314	18-0880	594	18-0936	197	18-0973	86
18-0781	314	18-0880-9	594	18-0936-9	197	18-0973-9	86
18-0782	314	18-0881-1	472-493	18-0937	591	18-0975	85
18-0785	313	18-0882	89	18-0937-9	591	18-0975-9	85
18-0786	313	18-0882-9	89	18-0939	594	18-0976	494
18-0791	196	18-0885-1	472-493	18-0939-9	594	18-0976-9	494
18-0792	255	18-0885-9	472-493	18-0940	195	18-0977	88
18-0793	255	18-0887	494-594-673	18-0941	88	18-0977-9	88
18-0794	255	18-0887-9	494-594-673	18-0942	195	18-0978	85
18-0795	255	18-0889	491-671	18-0943-1-9	674	18-0979	85
18-0796	255	18-0889-9	491-671	18-0943-2	583-592-674	18-0980	494-594
18-0797	255	18-0891	495-594-672	18-0943-2-9	583-592	18-0981	86
18-0798	314	18-0891-9	495-594-672	18-0944	195	18-0981-9	86
18-0799	314	18-0892	88-593	18-0945	86	18-0982-1	197
18-0807-1	313	18-0893	495-594-673	18-0946	195	18-0983	85
18-0808	314	18-0893-9	495-594-673	18-0947	593	18-0983-9	85
18-0809	313	18-0894	495	18-0947-9	593	18-0985	85
18-0812	314	18-0894-9	495	18-0948	492	18-0987	86
18-0813	314	18-0897	472-493	18-0948-9	492	18-0987-9	86
18-0815	314	18-0903	495-593-672	18-0949	90	18-0988	197
18-0823	314	18-0904	196	18-0949-9	90	18-0989	85
18-0826	316	18-0905	496	18-0950	496	18-0991	86
18-0829	314	18-0905-9	496	18-0951	85	18-0991-9	86
18-0835	197-314	18-0907	660	18-0952	197	18-0993	45
18-0836	314	18-0911	593	18-0952-9	197	18-0994	492
18-0840-1	313	18-0912	196	18-0953	89	18-0994-9	492
18-0844	314	18-0913	594	18-0953-9	89	18-0995	87
18-0847	314	18-0914	197	18-0954	493	18-0999-9	86
18-0849	307	18-0916	495	18-0955	86	18-1074	603-675
18-0850	84	18-0917	90	18-0956-1	494-592	18-1076	679
18-0850-9	84	18-0918	194	18-0957	87	18-1079	316
18-0851	89	18-0922	195	18-0959	85	18-1099	608

Código	Páginas	Código	Páginas	Código	Páginas	Código	Páginas
18-1112	208	18-1205	87	18-1277	353	18-1365	106-604
18-1113	208	18-1205-9	87	18-1278	354	18-1366	106-604
18-1115	208	18-1206	353	18-1282	36	18-1367	106
18-1117	105-208-526-604	18-1207	86	18-1285	87	18-1368	106
18-1118	208	18-1210	472-495	18-1286	75	18-1369	106
18-1122	208	18-1210-9	472-495	18-1287	110	18-1370	106-604
18-1127	527	18-1211	485-588-667	18-1288	110	18-1371	106-604
18-1129	527	18-1212	86	18-1289	110	18-1374	72
18-1142	526	18-1213	485-588-667	18-1290	110-111	18-1376	72
18-1143	208-527	18-1218	86	18-1291	110	18-1377	72
18-1144	208	18-1219	64-90	18-1292	110	18-1378	72
18-1148	481	18-1221	64-90	18-1293	110	18-1386	72
18-1150	527	18-1221-9	64-90	18-1296	72	18-1389	72
18-1151	134	18-1222	64-89	18-1299	106	18-1391	72
18-1152	134	18-1224	86	18-1300	481-588-667	18-1393	72
18-1153	181-208-527	18-1231	489-589-671	18-1308	481-588-667	18-1395	72
18-1154	105-181-208-604	18-1232	489-589-672	18-1309	481-588-667	18-1396	72
18-1155	208-528	18-1233	485-588	18-1311	481-588-667	18-1398	182
18-1156	23-208-527	18-1234	485-588-667	18-1315	481-588-667	18-1400	478-587-666
18-1157	23-208-527	18-1236	102-595	18-1316	481-588-667	18-1401	478-587-666
18-1158	23-106-208-527-604	18-1237	489-589-672	18-1317	481-588-667	18-1402	478-587-666
18-1159	208	18-1238	490-589-669	18-1327	481-588-667	18-1410	301
18-1160	528	18-1239	489-589-672	18-1329	481-588	18-1411	301
18-1161	106-527-604	18-1240	495	18-1332	667	18-1412	256
18-1162	208-527	18-1241	84	18-1333	481-588-667	18-1414	256
18-1164	209-527	18-1243	64	18-1337	481-588-667	18-1415	256
18-1165	527	18-1254	488	18-1339	481-588-667	18-1416	256
18-1166	209	18-1255	354	18-1341	481-588-667	18-1417	256
18-1170	209-604	18-1256	357-358	18-1343	111-608	18-1476	663
18-1171	604	18-1257	357	18-1344	106	18-1477	663
18-1172	604	18-1258	358	18-1345	181	18-1478	663
18-1173	527	18-1259	358	18-1346	182	18-1479	663
18-1179	527	18-1261	358	18-1350	106-604	18-1500	111-608
18-1182	527	18-1263	356-357	18-1351	106-604	18-1501	605-677
18-1186	181	18-1264	354	18-1352	71	18-1505	91
18-1190	208	18-1265	355-356	18-1353	71	18-1506	65
18-1191	208	18-1266	355-356	18-1354	106	18-15061	16
18-1193	527	18-1267	355-356-357	18-1355	106	18-1507	65
18-1194	181	18-1268	355-357	18-1356	106-526	18-1508	437
18-1196	181	18-1270	354	18-1357	106-604	18-15100	451
18-1197	208-527	18-1271	353	18-1358	604	18-15101	451
18-1202	88	18-1273	359	18-1360	71	18-15102	451
18-1202-9	88	18-1274	353	18-1361	72	18-15103	451
18-1204-1	472-494-593	18-1275	354	18-1363	106	18-15104	451
18-1204-1-9	472-494-593	18-1276	353	18-1364	106	18-15105	451

Código	Páginas	Código	Páginas	Código	Páginas	Código	Páginas
18-15112	451	18-1600	606	18-1833	291	18-1974-1	469
18-15114	451	18-1601	606	18-1834	291	18-1975-1	469
18-15115	451	18-1602	606	18-1843	468	18-1976-2	469
18-15116	451	18-1701	605	18-1845	469	18-1977-1	437
18-15119	451	18-1702	607	18-1848	656	18-1978	468
18-15121	451	18-1703	607	18-1876	582	18-1985	469
18-15122	451	18-1705	516	18-1898	466-581-656	18-1986-1	581-656
18-15123	451	18-1706	516	18-1901	581	18-1987-1	467
18-15125	451	18-1709	514	18-1902	581	18-1989	348-437
18-15128	147	18-1710	519	18-1903	581	18-1989K	348-437
18-15129	147	18-1711	515	18-1904	581	18-1990	469
18-15290	447-577-653	18-1713	598	18-1905	468	18-1991	468-582-657
18-15300	447-577-653	18-1714	608	18-1906	469	18-1992-1	468-582-657
18-15325	577-653	18-1718	114-598	18-1907	469-582-657	18-1993	437
18-15345	447-577-653	18-1721	108	18-1908	469	18-1994	437
18-15370	447-577-653	18-1722	108	18-1908K	469	18-1995	470
18-15380	447-577-653	18-1723	108	18-1909-1	582-657	18-1997-1	466-581-656
18-15390	447-577-653	18-1725	109	18-1910	437	18-1998-1	466-581
18-15400	577-653	18-1727	664	18-1921	582	18-1999	468-582-657
18-15405	447-577-653	18-1728	519	18-1922	582	18-2000	615
18-15410	447-577-653	18-1729	111	18-1930-2	656	18-2001	615
18-15415	447-577-653	18-1730	168	18-1931-1	656	18-2002	25-222-540-615
18-15430	447-577-653	18-17300	269	18-1932	656	18-2003	540
18-15435	577-653	18-17301	269	18-1935-1	657	18-2004	222-540
18-15440	577-653	18-1732	108-605	18-1936	656	18-2005	615
18-15450	577-653	18-1734	65	18-19360	658	18-2006	222-540
18-15455	577-653	18-1736	212	18-1937	469	18-2007	540
18-15460	577-653	18-1737	212	18-1939	469-582-657	18-2008	222-540
18-15470	577-653	18-1752	71	18-1949	469-657	18-2009	540
18-15480	577-653	18-1753	71	18-1950-1	466	18-2010	222-540
18-15495	577-653	18-1755	301	18-1951-1	466	18-2011	540
18-1550	212	18-1755K	301	18-1952-1	466	18-2012	615
18-15500	577-653	18-1756	301	18-1953-2	466	18-2013	540
18-15501	404	18-1757	256	18-1954-1	466	18-2014	540
18-1551	212	18-1757K	256	18-1955-1	467	18-2015	540
18-15520	577-653	18-1758	256	18-1956-2	467	18-2016	540-615
18-15550	577-653	18-1759	256	18-1957-1	467	18-2017	222-540
18-1560	212	18-1759K	256	18-1958-1	467	18-2018	615
18-1562	212	18-18000	147	18-1960-1	467	18-2019	540
18-1564	212	18-18100	147	18-1962-1	467	18-2020	615
18-1565	213	18-1830	290	18-1966	468	18-2022	615
18-1566	213	18-18303	249	18-1970-1	468	18-2023	615
18-1567	209	18-18304	249	18-1971	468	18-2024	615
18-1598	598	18-1831	290	18-1972	468	18-2025	615
18-1599	598	18-1832	290	18-1973	468	18-2026	540

Código	Páginas	Código	Páginas	Código	Páginas	Código	Páginas
18-2027	615	18-2094	496	18-2155	211	18-2202	524
18-2030	615	18-2097	515	18-2156	609	18-2203	513
18-2031	615	18-2100	516-598-676	18-2157	520	18-2204	513
18-2033	615	18-21001	515	18-2158	520	18-2205	513
18-2034	615	18-21005	516	18-2160	520	18-2206-1	523
18-2039	680	18-21005K	516	18-2161	517	18-2207	110
18-2040	680	18-21006	515	18-2162	517-521	18-2208	110
18-2041	680	18-2100K	516	18-2162E	517	18-2209	110
18-2043	680	18-2101	516	18-2163	517-521	18-2210	110
18-2044	680	18-2103	531	18-2163-9	517	18-2216	110-606
18-2045	680	18-2104	515-599-676	18-2163E-9	517	18-2217	110
18-2046	680	18-2105	531	18-2166	524	18-2218	110-606
18-2047	680	18-2106	531	18-2169	517	18-2219	110-606
18-2048	540	18-2107	531	18-2170	517	18-2220	110-606
18-2049	540	18-2108	531	18-2171	522	18-2221	110
18-2050	540	18-2109	531	18-2172	522	18-2224	114
18-2051	540	18-2110	215	18-2173	522	18-2225	114
18-2052	540	18-2111	215	18-2174	515-599-676	18-2226	114
18-2053	25-222-540	18-2112	532	18-2175	521	18-2227	114
18-2054	25-540	18-2113	532	18-21751	522-603-674	18-2228	114
18-2055	540	18-2114	532	18-21752-1	603-674	18-2229	598
18-2056	540	18-2115	532	18-21753	603-674	18-2230	598
18-2057	680	18-2116	532	18-21754	603	18-2231	598
18-2058	615	18-2125	514	18-21755	603	18-2236	212
18-2059	615	18-2126	532	18-2176	604	18-2239	212
18-2060	615	18-2128	515-603-676	18-2177	604	18-2243	112-605
18-2061	615	18-2130	526	18-2178	603	18-2243-9	112-605
18-2062	615	18-2136	532	18-2179	516	18-2244	211-530
18-2063	615	18-2137	532	18-2180	525	18-22441-9	211-530
18-2064	615	18-2138	611-677	18-2183	605	18-2245-1	603
18-2065	615	18-2140	497	18-2184	606	18-2246	603
18-2066	615	18-2141	497	18-2185	606	18-2248	520-521
18-2067	615	18-2142	534	18-2186	606	18-2250	109
18-2068	615	18-2143	186	18-2187	109-606	18-2251	109-606
18-2071	615	18-2144	186	18-2189	520	18-2252	109-606
18-2072	615	18-2145	520	18-2190	520	18-2254	212-524
18-2073	615	18-2145E	520	18-2190E	520	18-2256	513
18-2076	540	18-2146	514-599-676	18-2191	525	18-2257	514
18-2077	540	18-2148	534	18-2192	561	18-2258	514
18-2079	334	18-2149	520-521	18-2193	497	18-2259	514
18-2081	274	18-2150	526	18-2195	521	18-2260	212
18-2082	274	18-2151	535	18-2196	525	18-2261	525
18-2083	274-285	18-2152	535	18-2199	674	18-2277	108
18-2085	334	18-2153	677	18-2200	523	18-2279	108
18-2093	108	18-2154	526	18-2201	512	18-2282	510

Código	Páginas	Código	Páginas	Código	Páginas	Código	Páginas
18-2283	510	18-2342	525	18-2377-9	102	18-2423	534
18-2284	510	18-2343	497	18-2378	102-595	18-2424	534
18-2285	510	18-6429	248	18-2378-9	102	18-2425	534
18-2286	525	18-6831	248	18-23781-9	595	18-2426	534
18-2287	111	18-6941	248	18-2379	102	18-2427	534
18-2288	109	18-6945	248-43-248	18-2379-9	102	18-2428	534
18-2289	111	18-56008	248	18-2380	317	18-2429	534
18-2290	111	18-56009	248	18-2381	516	18-2430	199
18-2291	534	18-9802	248-34-140-275-403-562-640	18-2382	516	18-2430-9	199
18-2292	510	18-2343-9	497	18-2383	606	18-24301-9	199
18-2293	510	18-2345	536	18-2385	316	18-2432	674
18-2294	510	18-2345-9	536	18-2387	102-595	18-2433	674
18-2295	510	18-2346	525	18-23871-9	102-595	18-2434	401
18-2296	510	18-2348	524	18-2388	316	18-2435	532
18-2298	214-526	18-2348-9	524	18-2389	90	18-2436	532
18-2299	214-526	18-2349	496-530	18-2391	65-90	18-2443	511
18-2303	520	18-2353	526	18-2392	90	18-2448	24-316
18-2303-9	520	18-2354	526	18-2393	535	18-2450	511
18-2308	111	18-2355	109	18-2394	535	18-2451	511
18-2309	111	18-2357	524	18-2395	535	18-2452	511
18-2310	111	18-2358	512	18-2396	535	18-2453	511
18-2315	111	18-2359	212-525	18-2397	535	18-2454	611-677
18-2316	497	18-2360	523	18-2398	112	18-2460	530
18-2316-9	497	18-23601	265	18-2399	112-609	18-2461	533
18-2320	526	18-23602	265	18-2400	510	18-2462	533
18-23205	133-265	18-2361	497	18-2401	512	18-2463	534
18-23207	238	18-2361-9	497	18-2404	524	18-2464	534
18-2321	522	18-2363	512	18-2405	524	18-2465-9	533
18-2322	517	18-2364	512	18-2406	523	18-2466-9	533
18-2323	522	18-2365	512	18-2407	524	18-2470	22
18-2324	516	18-2366	676	18-2408	523	18-2471	22
18-23251	15	18-2367	664	18-2409	523	18-2472	22
18-2326	108	18-2368	524	18-2410	523	18-2473	22
18-2327	108	18-2369	524	18-2411	510	18-2480	22
18-2330	108	18-2370	209	18-2412	522	18-2481	22
18-2331	525	18-2371	316	18-2413	522	18-2482	22
18-2336	536	18-23711-9	316	18-2414	522	18-2495	21
18-2336-9	536	18-2372	533	18-2415	511	18-2496	21
18-2337	598-676	18-2373	533	18-2416	511	18-2499	21
18-2338	599	18-2374	316	18-2417	511	18-2500	195
18-2339	599-676	18-23741-9	316	18-2418	511	18-2500-9	195
18-2340	497	18-2375	211-530	18-2419	511	18-25001	494
18-2340-9	497	18-23751-9	211-530	18-2420	534	18-25002	494
18-2341-1	536	18-2376	526	18-2421	534	18-2501	194
18-2341-1-9	536	18-2377	102	18-2422	534	18-2501-9	194

Código	Páginas	Código	Páginas	Código	Páginas	Código	Páginas
18-2502	195	18-2533	603	18-25602	266	18-2599	217-517
18-2502-9	195	18-2534	90	18-25604	266	18-2600	521
18-2503	197	18-2536	89	18-25605	267	18-26002-1	385
18-2503-9	197	18-2536-9	89	18-2561	197	18-2601-1	518
18-2504	195	18-2537	90	18-2561-9	197	18-2603	521
18-2504-9	195	18-2539	89	18-2562	198	18-2603E	521
18-2505	195	18-2539-9	89	18-2562-9	198	18-2604	521
18-2505-9	195	18-25400	133	18-2563	22-198	18-2604E	521
18-2506-1	197	18-2541	592	18-2563-9	22-198	18-2605	289
18-2506-1-9	197	18-2543	88	18-2564	22-198-495	18-2606	289
18-2507	195	18-2543-9	88	18-2564-9	22-198-495	18-2607	289
18-2507-9	195	18-2544	88	18-2565	22-198-496	18-2608	22
18-2508-1	197	18-2544-9	88	18-2565-9	22-198-496	18-2609	22
18-2508-1-9	197	18-2545	86	18-25650	266	18-2610	196
18-2509	193	18-2545-9	86	18-25651	266	18-26104-1	387-553
18-2509-9	193	18-2546	89	18-25652	266	18-2611	196
18-2510	194	18-2546-9	89	18-2566	198-496	18-26110-1	387-553
18-2510-9	194	18-2547	89	18-2566-9	198-496	18-26111-1	385
18-2511	197	18-2547-9	89	18-2568	194	18-26112-1	387-553
18-2511-9	197	18-2548	89	18-2568-9	194	18-2613	590
18-2512	194	18-2548-9	89	18-2569	194	18-2614	498
18-2513	194	18-2549	86	18-2569-9	194	18-2615	498
18-2514	194	18-2549-9	86	18-2570	194	18-2617	498
18-2516	495	18-2550	87	18-2570-9	194	18-2619-1	498-521
18-2516-9	495	18-2550-9	87	18-2571	193	18-2620	498
18-2519	673	18-25513	134	18-2571-9	193	18-2621	194
18-2519-9	673	18-2552	492	18-2572	193	18-2622	517
18-25200	19	18-2552-9	492	18-2572-9	193	18-2623	116
18-2524	22	18-2553	492	18-2573	195	18-2624	217
18-2525	673	18-2553-9	492	18-2573-9	195	18-2625	680
18-2525-9	673	18-2554	492	18-2574	195	18-2626	217
18-25250	673	18-2554-9	492	18-2574-9	195	18-2627	217
18-25251	673	18-2555	492	18-2575	194	18-2628	218
18-2526	673	18-2555-9	492	18-2575-9	194	18-2629	218
18-2526-9	673	18-2556	495	18-2579	84	18-2635	218
18-2527	673	18-2556-9	495	18-2582	84	18-2642	218
18-2527-9	673	18-2557	89	18-2583	680	18-2643	537
18-2528	673	18-2557-9	89	18-2584	680	18-2644	537
18-2528-9	673	18-2558	197	18-2586	679	18-2645	538
18-2529	673	18-2558-9	197	18-2592	313	18-2646-1	219-537
18-2529-9	673	18-2559	197	18-2593	198	18-2648	538
18-2530	673	18-2559-9	197	18-2595	120	18-2649	534
18-2530-9	673	18-2560	199	18-2596	668	18-2652	538
18-25300	266	18-2560-9	199	18-2597	680	18-2653	219
18-2532	90	18-25600	266	18-2598	679	18-2654	219

Código	Páginas	Código	Páginas	Código	Páginas	Código	Páginas
18-2655	219	18-2702-1-9	536	18-2751	519	18-2800-9	193
18-2656	116	18-2703	90	18-2752	519	18-2801	198
18-2657	116	18-2703-9	90	18-2753-1	521	18-2801-9	198
18-2658	117	18-2704	90	18-2753-2	519	18-2802	193
18-2659	117	18-2705	90	18-2755	675	18-2802-9	193
18-2660	117	18-2705-9	90	18-2756	519	18-2803	193
18-2663	612	18-2706	90	18-2757	675	18-2803-9	193
18-2664	612	18-2706-9	90	18-2758	675	18-2804	193
18-2665	612	18-2707	526	18-2759	519	18-2804-9	193
18-2666	612	18-2707-9	526	18-2760	519	18-2805	195
18-2667	613	18-2708	90	18-2761	519	18-2805-9	195
18-2669	613	18-2708-9	90	18-2762	519	18-28050	630
18-2670	613	18-2709	89	18-2763	603	18-28051	631
18-2671	613	18-2709-9	89	18-2764	603	18-2806	195
18-2672	614	18-2710	194	18-2765	603-675	18-2806-9	195
18-2673	614	18-2712	194	18-2766	675	18-2807	195
18-2674	614	18-2713	196	18-2767	603	18-2807-9	195
18-2679	117	18-2714	196	18-2768	603	18-2808	195
18-2680	117	18-2715	517	18-2769	90	18-2808-9	195
18-2681	117	18-2716	196	18-2769-9	90	18-28080	138
18-26810	382-549-632	18-2717	196	18-2770	519	18-28081	138
18-26811	382-549-632	18-2721	194	18-2771	602	18-28082	138
18-26812	382-549-632	18-2724	517	18-2772-1	602-675	18-28083	138
18-26813	382-549-632	18-2725	220	18-2773	316	18-28084	138
18-2682	117	18-2726	679	18-2774	660	18-28085	138
18-2683	117	18-2727	431	18-2775	660	18-28086	138
18-2684	117	18-2728	199	18-2776	660	18-2809	197
18-2685	117	18-2729	194	18-2777	660	18-2809-9	197
18-2686	118	18-2732	431	18-2778	660	18-28090	35
18-2687	118	18-2732-9	431	18-2779	583-650	18-28092	35
18-2688	118	18-2733	431	18-2780-1	650	18-2810	196
18-2689	118	18-2735	196	18-2781	583-650	18-2810-9	196
18-2690	118	18-2736	191	18-2782	316	18-2811	669
18-2691	118	18-2739	196	18-2783	614	18-2813	668
18-2692	118	18-2740	195	18-2785	220-331	18-2814	668
18-2694	118	18-2741	196	18-2787	220-331	18-2815	495-594-671
18-2697-1	220	18-2742	217	18-2788	332	18-28150	344
18-2698	610	18-2743	495-521	18-2789	332	18-28151	344
18-2699	590-668	18-2744	675	18-2791	614-680	18-2816	669
18-2700	216	18-2745	603	18-2792	332	18-2817	669
18-2701	536	18-2746	519	18-2793	664	18-28175	345
18-2701-04	536	18-2747	519	18-2794-1	332	18-2818	669
18-2701-9	536	18-2748	519	18-2798	332	18-2819-1	472-493
18-2702-04	536	18-2749	194	18-2799	332	18-2819-9	472-493
18-2702-1	536	18-2750	519	18-2800	193	18-2820	495-521

Código	Páginas	Código	Páginas	Código	Páginas	Código	Páginas
18-2820-9	495	18-2849-1	472-493	18-2871-9	87	18-2896	584
18-2823	198-496	18-2849-9-1	472-493	18-2872	88	18-2896-1	472-493-592
18-2823-9	198-496	18-2850	584-592	18-2872-9	88	18-2898	87
18-2824	198-496	18-2850-9	584-592	18-2873	88	18-2898-9	87
18-2824-9	198-496	18-2851	594	18-2873-9	88	18-2900	85
18-2825	198-496	18-2851-9	594	18-2874	89	18-2900-9	85
18-2825-9	198-496	18-2852	87	18-2874-9	89	18-2901	87
18-2826	198-496	18-2852-9	87	18-2875-1	584-592-658	18-2901-9	87
18-2826-9	198-496	18-2853	86	18-2875-1-9	584-592-658	18-2902-1	584-659
18-2827	198	18-2853-9	86	18-2876	88	18-2902-9	584-659
18-2827-9	198	18-2854-1	472-584-658	18-2876-9	88	18-2903	84
18-2828	198	18-2854-9	472-584-658	18-2877	87	18-2903-9	84
18-2828-9	198	18-2855	89	18-2877-9	87	18-2904	88
18-2830-1	472-493-592	18-2855-9	89	18-2878	87	18-2904-9	88
18-2831	492	18-2856	88	18-2878-9	87	18-2905	88
18-2831-9	492	18-2856-9	88	18-2879	85	18-2905-9	88
18-2832-1	472-493	18-2857	85	18-2879-9	85	18-2906	84
18-2832-1-9	472-493	18-2857-9	85	18-2880	89	18-2906-9	84
18-2833	472-493	18-2858	591-671	18-2880-9	89	18-2907	88
18-2833-9	472-493	18-2858-9	591-671	18-2881	91	18-2907-9	88
18-2834	492	18-2859	592	18-2881-9	91	18-2908	84
18-2834-9	492	18-2859-9	592	18-2883-1	592	18-2908-9	84
18-2835	197	18-2860	592	18-2883-1-9	592	18-2909	472-494-593-671
18-2835-9	197	18-2860-9	592	18-2884	81	18-2909-9	472-494-593-671
18-2836	195	18-2861-1	584-592	18-2884-9	81	18-2911	595
18-2836-9	195	18-2861-9	584-592	18-2885	81	18-2911-9	595
18-2837	196	18-2862	86	18-2885-9	81	18-2912-1	472-494-592
18-2837-9	196	18-2862-9	86	18-2886	87	18-2913	87
18-2838	195	18-2863	594	18-2886-9	87	18-2913-9	87
18-2838-9	195	18-2863-9	594	18-2887	91	18-2914	199-496
18-2839	195	18-2864	87	18-2887-9	91	18-2914-9	199-496
18-2839-9	195	18-2864-9	87	18-2888	81	18-2915	199-496
18-2840	495	18-2865	87	18-2888-9	81	18-2915-9	496
18-2840-9	495	18-2865-9	87	18-2889	85	18-2916	594
18-2841	198	18-2866	86	18-2889-9	85	18-2916-9	594
18-2841-9	198	18-2866-9	86	18-2890	84	18-2917	492-591
18-2843	492-521	18-2867	86	18-2890-9	84	18-2917-9	492-591
18-2843-9	492	18-2867-9	86	18-2891	90	18-2918	595
18-2844	492	18-2868	87	18-2891-9	90	18-2918-9	595
18-2844-9	492	18-2868-9	87	18-2892	85	18-2919	199-496
18-2845	494-593	18-2869	90	18-2892-9	85	18-2919-9	199-496
18-2847	495	18-2869-9	90	18-2893	84	18-2922	671
18-2847-9	495	18-2870	86	18-2893-9	84	18-2923	672
18-2848	492	18-2870-9	86	18-2894	87	18-2924	672
18-2848-9	492	18-2871	87	18-2894-9	87	18-2925	671

Código	Páginas	Código	Páginas	Código	Páginas	Código	Páginas
18-2926	672	18-2962	81	18-3035	253	18-3080	652
18-2927	672	18-2963	81	18-3036	652	18-3081	652
18-2928	671	18-2964	82	18-3037	651	18-3082	55
18-2929	674	18-2965	669	18-3038	651	18-3083	55
18-2929-9	674	18-2966	669	18-3040	288	18-3086	572
18-2930	671	18-2968	670	18-3042	288	18-3087	430
18-29322	549-626	18-2970	670	18-3043	54	18-3088	288
18-2933	671	18-2971-1	659-671	18-3044	54	18-3089	652
18-2933-9	671	18-29716	344	18-3046	651	18-3090	55
18-2934	673	18-2972	672	18-3047	651	18-3091	55
18-2934-9	673	18-2979-9	673	18-3049	253	18-3092	253
18-2935	673	18-2980	669	18-3050	54	18-3094	253
18-2935-9	673	18-2982	669	18-3050-10	54	18-3095	253
18-2936	673	18-2983	669	18-3051	54	18-3096	253
18-2936-9	673	18-2989	671	18-3052	167	18-3097	253
18-2937	673	18-2989-9	671	18-3053-1	55	18-3098	168
18-2937-9	673	18-2990	674	18-3055	55	18-3099	55-253
18-2938	87	18-2990-9	674	18-3056	20-167-430	18-3100	20
18-2938-9	87	18-29904	344	18-3056-10	20-167-430	18-3102	55
18-2939	674	18-2991-1	659-672	18-3057	167	18-3103	55
18-2939-9	674	18-2991-9	659-672	18-3058	572	18-3104-1	55
18-29417	381-548-626	18-2994	674	18-30585	572	18-3106	650
18-2943	195	18-2994-9	674	18-3059	55	18-3107	168
18-2944	496	18-2995	671	18-3059-10	55	18-3108	56-574
18-2944-9	496	18-2995-9	671	18-3060	651	18-3109	168-430
18-2945	22-102-199-496-595-674	18-2996	595-674	18-3061	651	18-3110	168-430
18-2945-9	22-102-199-496-595	18-2996-9	595-674	18-3062	167	18-3111	574
18-29451-9	22-102-496-674	18-2998	669	18-3063	167-288	18-3113	168
18-2946	491-591-669	18-3000	253	18-3065	288	18-3114	168-431
18-2947	592	18-3001	54	18-3066	167-288	18-3115	168
18-2947-9	592	18-3002	54	18-3067	167-288	18-3116	168-431
18-2948	199-496	18-3003	54	18-3068	288	18-3117	168-431
18-2948-9	199-496	18-3006	54	18-3069	167-288	18-3118	168
18-2949	472-494-584-659-672	18-3007	167-430	18-3070	288	18-3119	574
18-2949-9	472-584-659-672	18-3007-10	167-430	18-3071	288	18-3121	574
18-2950	81	18-3008	167	18-3072	167-288	18-3122	21-168-431
18-2951	81	18-3012	167	18-3073	168-288	18-3126	56
18-2952	81	18-3013	168	18-3074	168-288	18-3127	55
18-2954	81	18-3014	168	18-3075	651	18-3129	56
18-2956	81	18-3015	54	18-3076	651	18-3133	61-84
18-2957	81	18-3016-1	430	18-3077	651	18-3135	61-84-598
18-2958	81	18-3017	167-430	18-30777	652	18-3135-9	84
18-2959	81	18-3017-10	167-430	18-30778	651	18-3136	61-84
18-2960	81	18-3023	253	18-3078	651	18-3136-9	84
18-2961	81	18-3031	20	18-3079	651	18-3138	56

Código	Páginas	Código	Páginas	Código	Páginas	Código	Páginas
18-3139	168	18-3203	56	18-3248	20	18-3294	168
18-3141	574	18-3204	215	18-3249	20	18-3295	56
18-3142	290	18-3204-9	215	18-3250	20	18-3296	253
18-3143	290	18-3205	652	18-3252	170	18-3297	289
18-3145	574	18-3206	574	18-3253	254	18-3299	56
18-3147	432	18-3207	169	18-3254	254	18-3300	168-289
18-3148	172-291	18-3208	652	18-3255	254	18-3301	289
18-3149-1	169	18-3209	652	18-3256	254	18-3302	289
18-3150	432	18-3210	56	18-3257	254	18-3305	168-289
18-3151	168-431	18-3211	57	18-3258	254	18-3309	432
18-3153	61-84	18-3212-1	575	18-3259	254	18-3310	293
18-3155	432	18-3214	21-169-432	18-3260	254	18-33104	410
18-3160	432	18-3214D	432	18-3261	652	18-3311	293
18-3162	288	18-3215	169	18-3262	652	18-3312	293
18-3163	290	18-32153	19	18-3263	652	18-3313-1	293
18-3164	288	18-32154	250	18-3264	254	18-3314	171
18-3166	291	18-3216	432	18-3265	170	18-3315-2	61
18-3170	289	18-3217	170-432	18-3266	255	18-3316	171
18-3171	289	18-3217D	432	18-3267	255	18-3317	433
18-3173-1	289	18-3219	517	18-3268	20	18-3318	432
18-3175	650	18-3220	431	18-3269	20	18-3319	171
18-3176	291	18-3221	431	18-3270	20	18-3320	433
18-3178	56	18-3222	431	18-3271	20	18-33207	409
18-3179	55	18-3223-9	659	18-3273	21	18-3321	433
18-3180	56	18-3226	431	18-3274	651	18-33211	409
18-3182	55	18-3226-9	431	18-3275	651	18-3322	171
18-3185	289	18-3227	168-431	18-3276-1	651	18-3323	172
18-3186	290	18-3227-9	168-431	18-3277	651	18-3324	172
18-3187	21	18-3229	431	18-3278	21	18-3325	57
18-3188	253	18-3229-9	431	18-3279	21	18-3326	56
18-3189	253	18-3230	497	18-3280	21	18-3327	57
18-3190	254	18-3231	497	18-3281	21	18-3328	289
18-3191	254	18-3232	536	18-3282	21	18-3329	90
18-3192	254	18-3232-9	536	18-3283	21	18-3332	90
18-3193	254	18-3236	497	18-3284	21	18-3333	289
18-3194	290	18-3237	432	18-3285	21	18-3336	56
18-3195	290	18-3238	57	18-3286	575	18-3337	90
18-3196	290	18-3239	170	18-3287	651	18-3343	56
18-3197	431-497	18-3242	254	18-3288	23	18-3344	290
18-3198	526	18-3243	254	18-32882	680	18-3345	290
18-3199	526	18-3244	254	18-3289	496	18-3346	55
18-3200	24-215-530	18-3245	20	18-3290	52	18-3348	575
18-3200-9	24-215-530	18-32455	20	18-3291	253	18-3349	575
18-3201	56	18-3246	20	18-3292	253	18-3350	431
18-3202	56	18-3247	20	18-3293	168-431	18-3351	431

Código	Páginas	Código	Páginas	Código	Páginas	Código	Páginas
18-3356	289	18-3404	253	18-3446	172	18-3520	289
18-3357	290	18-3405	56	18-3448	173	18-3521	289
18-3358	56	18-3406	170	18-3449	289	18-3522-1	292
18-3359	55	18-3407	170	18-3450	292	18-3523-1	292
18-3360	88	18-34075	418	18-34500	153-240	18-3524	298
18-3363	56	18-3408	291	18-3451	292	18-3525	298
18-3365	61-84	18-34080	352	18-3453	57	18-3530-1	437
18-3366	55	18-34081	352	18-3454	57	18-35302	279
18-3367	56	18-34082	352	18-3455	56	18-35304	279
18-3368	55	18-34083	352	18-3456	289	18-3531	437
18-3369	61-84	18-34084	352	18-3460	292	18-3534	166
18-3370	293	18-3409	291	18-34600	276	18-3535	166
18-3371	293	18-3410	291	18-34601	276	18-3536	166
18-3372	293	18-3411	292	18-34602	276	18-3537	166
18-3373	293	18-34110	347	18-34603	276	18-3538	661
18-3374	294	18-3412	292	18-34604	276	18-3539	660
18-3376	57	18-3413	295	18-34605	276	18-3540	298
18-3377	57	18-3414	169	18-3461	292	18-3541	298
18-3378	58	18-34140	347	18-3462	292	18-3543	65
18-3379	58	18-3415	294	18-3463	292	18-35433	423
18-3380	58	18-3416	169	18-3464	292	18-35435	347
18-33800	409-649	18-3417	431	18-3465	292	18-35436	348
18-3381	58	18-3419	169	18-3466	292	18-35437	423
18-3382	58	18-3420	431	18-3469	575	18-3544	65
18-3383	58	18-3421	431	18-3480	255	18-35442	645
18-3384	58	18-3422	169	18-3481	255	18-35443	370
18-3385	59	18-3423	169	18-3495	249	18-35444	370
18-3386	575	18-3424	169	18-3496	249	18-3545	65
18-3387	59	18-3425	173-294	18-3497	48-249	18-3546	65
18-3388	59	18-3426	173-294	18-3498	48-249	18-3549	167-436
18-3389	59	18-3427	173-295	18-3499	48-249	18-3550	436
18-3390	59	18-3428-1	295	18-3500	65	18-3551	436
18-3391	59	18-3429	295	18-3501	56	18-3552	436
18-3392	60	18-3430	295	18-3502	574	18-3553	167
18-3393	60	18-3431	295	18-3504	651	18-3554	575
18-3394	60	18-3432	292	18-3505	291	18-3555	436
18-3395	294	18-3433	295	18-3506	430-650	18-3556	167
18-3396-1	294	18-3434	294	18-3507	171	18-3557	65-436-660
18-3397	291	18-3435	168-289	18-35101	347	18-3558	575-660
18-3398	294	18-3436	168-290	18-35102	347	18-3560	65
18-3399	60	18-3440	295	18-3515	292	18-3561	65
18-3400	61	18-3442	292	18-3516	292	18-3562	64
18-3401	61	18-3443	289	18-3517	171-433	18-3563	64
18-3402	61	18-3444	289	18-3518	289	18-3564	64
18-3403	61	18-3445	169	18-3519	289	18-3565	65

Código	Páginas	Código	Páginas	Código	Páginas	Código	Páginas
18-3566	65	18-3647	436	18-3714	215-531	18-3769	604
18-3567	64	18-3648	436	18-3715	103-609	18-3770	599
18-3568	436	18-3649	436	18-3716	103-609	18-3771	318
18-3569	166	18-3650	436	18-3717	103	18-3773	318
18-3570	173	18-3651	436	18-3719	212-525-604	18-3774	258
18-3571	172	18-3652	436	18-3720	214-533	18-3775	258
18-3572	172	18-3653	575	18-3721	214-497-533	18-3777	258
18-3573	430	18-3654	660	18-3721-9	497	18-3778	258
18-3575	430-571-650	18-3656	661	18-3722	214-533-611-677	18-3781	318
18-3577-1	430-571-650	18-3658	661	18-3722-9	611-677	18-3782	318
18-3584	430-571-650	18-3659	661	18-3723	214-533	18-3783	530
18-3586	650	18-3660	661	18-3725	604	18-3784	530
18-3593	430	18-3662	661	18-3725-9	604	18-3785	530
18-3599-1	430-571-650	18-3663	661	18-3726	258-318	18-3786	530
18-3600	432	18-3664	661	18-3728	497	18-3787	530
18-36001	432	18-3665	661	18-3729	497	18-3788-9	530
18-3601	445	18-3666	661	18-3730	609-676	18-3791	318
18-3602	445	18-3667	436	18-3731	604	18-3792	318
18-3603	445	18-3668	436	18-3731-9	604	18-3800	82
18-3605	166	18-3669	65	18-3732	318	18-38008	18
18-3606	166	18-3670	576-661	18-3733	609-677	18-3801	82
18-3607	216	18-3672	166	18-3735	103-258-317	18-3802	82
18-3608	298	18-3673	65	18-3737	258	18-3803	82
18-3609	298	18-3674	65	18-3740	103	18-3804	191-305
18-3610	608	18-3675	195	18-3741	103-609	18-3805	305
18-3611	298	18-3676	576-661	18-3741-9	609	18-3806	256
18-3615	661	18-3677	576-661	18-3742	103-609	18-3807	256
18-3617	661	18-36850	153	18-3742-9	609	18-3808	256
18-3618	661	18-36905	644	18-3743	103	18-3809	256
18-3619	661	18-36906	419	18-3744	103-677	18-3810	256
18-3620	661	18-36956	153	18-3744-9	677	18-3813	256
18-3621	661	18-3700	215-531	18-3745	677	18-3814	257
18-3622	298	18-3701	24-215-530	18-3745-9	677	18-3816	257
18-3623	298	18-3702	215	18-3748	317	18-3817	257
18-3624	298	18-3703	215	18-3749	517	18-3819	257
18-3625	298	18-3704	215	18-3751	214-526	18-3820	257
18-3626	661	18-3705	103-609	18-3752	517	18-3822	257
18-3627	19	18-3705-9	609	18-3754	521	18-3823	257
18-3628	19	18-3706	103	18-3755	530	18-3824	257
18-3629	19	18-3707	103	18-3756	530	18-3825	257
18-3630	20	18-3708-1	103-609-677	18-3759	525	18-3827	191-305
18-3631	167	18-3709	318	18-3760	517	18-3828	191-305
18-3632	298	18-3710	258	18-3763	598	18-3829	305
18-3644	436	18-3712	516	18-3766	111-608	18-3830	305
18-3646	436	18-3713	516	18-3768	608	18-3831	305

Código	Páginas	Código	Páginas	Código	Páginas	Código	Páginas
18-3832	305	18-3896	82	18-4082	300	18-4215	677
18-3834	670	18-3898	82	18-4083	300	18-4216	659
18-3836	82	18-3899	88	18-4084	300	18-4217	659
18-3837	82	18-3928	478	18-4085	300	18-4218	473-582-659
18-3838	82	18-39320	300	18-4091	300	18-4218D	659
18-3839	82	18-3934	300	18-4093	300	18-4219	659
18-3841-2	82	18-3937	478-666	18-4097	300	18-4220	530-216
18-3842	670	18-3938	478-666	18-4099	300	18-4220D	216
18-3843	670	18-3939	478-666	18-4109	478	18-4221	216
18-3844	191	18-3942	478	18-4128	300	18-4222	609
18-3845	191	18-3944	478	18-4129	300	18-4223	609
18-3847	305	18-39480	256	18-4132	300	18-4224	473
18-3848	305	18-39530	256	18-4133	300	18-4226	473
18-3849	305	18-3954	300	18-4134	478	18-4227	473
18-3850	243	18-39540	256	18-4135	300	18-4228	103-609
18-3861	191	18-3960	300	18-4138	300	18-4231	103-609
18-3862	191	18-3963	300	18-4141	300	18-4232	103
18-3863	191	18-3969	300	18-4142	300	18-4233	216
18-3864	191	18-3976	300	18-4143	300	18-4234	676
18-3866	82	18-4005	664	18-4145	300	18-4236	660
18-3867	670	18-4007	657	18-4146	300	18-4236-9	660
18-3868	670	18-4008	470	18-4148-1	71	18-4238	677
18-3869	670	18-4009	470-582	18-4150	660	18-4238-9	677
18-3870	668	18-40110	256	18-4157	301	18-4239	677
18-3871	191	18-40140	256	18-4160	478-666	18-4241	677
18-3872	191	18-4022	485	18-4161	478-666	18-4241-9	677
18-3873	670	18-4023	485	18-4164	478-666	18-4245	664
18-3874	491-591	18-4024	485-595-667	18-4173	478-666	18-4246	664
18-3876	491-591-670	18-4024-9	485-595-667	18-4178	478	18-4247	664
18-3877	491-591	18-4029	663	18-4180	478	18-4248	102-595
18-3878	491-591	18-4031	667	18-4189	478	18-4248-9	102-595
18-3879	491-591-670	18-4036	181	18-4191	478	18-42481-9	102-595
18-3880	491-591	18-4037	181	18-4194	609-677	18-4249	103
18-3881	491-591	18-4038	181	18-4200	664	18-4250	595
18-3883	491-591-670	18-4039	181	18-4201	664	18-4250-9	595
18-3886	243	18-4040	72	18-4204	676	18-4251	604
18-3887	491-591-670	18-4044	653-663	18-4205	676	18-4251-9	604
18-3888	680	18-4046	653-663	18-4206	676	18-4252	535
18-3889	660	18-4075	71	18-4208	676	18-4252-9	535
18-3890	660	18-4075-9	71	18-4209	676	18-4253-9	102-595
18-3891	305	18-4076	71	18-4210	676	18-42531-9	102-595
18-3892	305	18-4077	301	18-4211	676	18-4255	102
18-3893	679	18-4078	301	18-4212	677	18-4256	582-659
18-3894	305	18-4080	300	18-4213	677	18-4257	470-582-659
18-3895	82	18-4081	300	18-4214	677	18-4258	470-582-659

Código	Páginas	Código	Páginas	Código	Páginas	Código	Páginas
18-4259	673	18-4318	79	18-4380	490	18-4456	539
18-4261	200	18-4319	188	18-4381	489	18-4457	539
18-4263	470-582-659	18-4321	79	18-4382	489	18-4458	539
18-4264	470-582-659	18-43212	169-243	18-4383	487	18-4459	215-531
18-4265	470	18-4322	79	18-4384	487	18-4461	473-582-659
18-4267	497	18-4323	80	18-4385	488	18-4463	663
18-4267-9	497	18-4325	188	18-4386	487	18-4464	663
18-4270	497	18-4326	186	18-4387	488	18-4465	663
18-4270-9	497	18-43263	289	18-4388	488	18-4466	663
18-4272	497	18-4329	75	18-4389	488	18-4467	663
18-4273	497	18-4330	75	18-4391	488	18-4468	663
18-4274	316	18-4331	75	18-4392	488	18-4469	663
18-4275	200	18-4332	75	18-4394	486	18-4470	663
18-4276	61-84	18-4334	186	18-4395	487	18-4471	663
18-4276-9	84	18-4336	186	18-4396	487	18-4472	663
18-42850	256	18-4337	187	18-4397	487	18-4473	663
18-42860	256	18-4339	187	18-4398	487	18-4474	663
18-42870	256	18-4340	187	18-4399	487	18-4484HP	349
18-4288	536	18-4341	668	18-4400	303	18-4485	349-477-586-665
18-4288-9	536	18-4342	668	18-4402	80	18-4485HP	349
18-4289	536	18-4347-1	486	18-4403	303	18-4486	349-477-586-665
18-4289-9	536	18-4348	486	18-4404	303	18-4486HP	349-477-586-665
18-42940-9	256	18-4349	486	18-4405	303	18-4487	348
18-4295	526	18-4351	189	18-4406	80	18-4488	348
18-4295-9	526	18-4353	189	18-4407	303	18-4489	349-477-586-665
18-42950-9	256	18-4354	189	18-4408	486-590-658	18-4491	350-477-586-665
18-4296	517	18-4355	190	18-4409	303	18-4492	349-478
18-42960-9	256	18-4356	190	18-44092	445	18-4493HP	350
18-4299	244	18-4357	190	18-4411	303	18-4497	350
18-4300	76	18-4359	191	18-4412	303	18-4501	350-477-586-665
18-4301	76	18-4362	470	18-4413	304	18-4501HP	350-477-586-665
18-43015	436	18-4363	470-583	18-4415	304	18-4506	348
18-43017	436	18-4364	470-583-657	18-4417	304	18-4507	349
18-4302	77	18-4365	488	18-4419	304	18-4508	348
18-4303-1	77	18-4366	490	18-4420	80	18-4511	350
18-4304-1	77	18-4367	486	18-4421	80	18-4512	350
18-4305	77	18-4369	590	18-4422	304	18-4513	350
18-43051	167	18-4370	590	18-4427	304	18-4514	350
18-43052	166	18-4371	590	18-4428	80	18-4516	350
18-4306	78	18-43716	288	18-4434	243	18-4517	350
18-4307	78	18-4373	590	18-4435	243	18-4518	350
18-4309	78	18-4374	590	18-4436	243	18-4519	350
18-4310	78	18-4375	490	18-4442	523-598	18-4521	350
18-4317	188	18-4377	490	18-4444	215-531-609	18-4522	350
18-43175	166-242	18-4378	490	18-4446	215-531	18-45221	55

Código	Páginas	Código	Páginas	Código	Páginas	Código	Páginas
18-4523	351	18-4915	200	18-5165	238	18-5256	546-625
18-45312	55-168	18-50000	271	18-5166	238	18-5258	378-546
18-45404	242	18-50001	271	18-5169	132-133	18-5260	378-546-625
18-45714	373	18-5001	29-546	18-5170	30	18-5264	625
18-4697	659	18-5002	29	18-5172	30	18-5265	625
18-4698	200-316	18-5003	29	18-5176	30	18-5266	378-546-625
18-46981-9	200-316	18-5006	29	18-5178	133	18-5267	378
18-4699	659	18-5007	132	18-5179	30	18-5268	378-546
18-4712	71	18-5011	29	18-5180	133	18-5269	378-546
18-4726	351	18-5012	132	18-5181	30-133	18-5271	378-546
18-4727	351	18-5021	470	18-5182	133-238	18-5272	546
18-4728	351	18-51000	244	18-5183	265	18-5273	378
18-4729	351	18-51001	316	18-5185	133-238	18-5274	379
18-4730	351	18-51002	316	18-5186	133	18-5275	379-546
18-4731	351	18-51003	316	18-5187	133	18-5276	379-547
18-4732	351	18-5107-1	382-548-627	18-5192	30	18-5277	379-547
18-4733	351	18-5108	382-548-627	18-5193	30	18-5278	379-547
18-4734	351	18-5110	265	18-5194	30	18-5279	547
18-4735	351	18-5111	265	18-5195	265	18-5280	379-547
18-4736	351	18-5112	265	18-5196	30	18-5281	379-547
18-4737	351	18-5113	266	18-5199	29	18-5282	379
18-4749-9	598	18-5116-1	382	18-5200	29-547	18-5283	379-547
18-4750	608	18-5117	382	18-5205	29	18-5284	625
18-4804	598	18-5119	266	18-5206	132-133	18-5285	345-383-550
18-4805	598	18-5128	265	18-5207	133	18-5286	345-383-550-628-629
18-4806	598	18-5130	265	18-5224	15-36-138-238-247-267-398-555-632	18-5287-1	550
18-4807	111	18-5131	265	18-5224-9	15-36-138-238-247-267-398-555-632	18-5288	345-383-550-629
18-4826	102	18-5132	265	18-5225	15-36-130-138-238-247-267-398-555-631	18-5289	345-383-550-628-629
18-4828	608	18-5133	238	18-5226	15-36-130-138-238-247-267-398-555-632	18-5290	345-383-550
18-4830	213	18-5134	238	18-5229-9-1	35	18-5291	378
18-48317	173-243	18-5135	266	18-5230-9-1	35	18-5292	629
18-4833	574	18-5136	266	18-5231-1D	35	18-5293-1	550
18-4835	604	18-5138	266	18-5239	629	18-5294	383-550-628-629
18-4837	574	18-5139	132	18-5240	629	18-5295	383-550-628-629
18-4840	102	18-5140	133	18-5241	130	18-5296-2	383-551
18-4841	102	18-5141	29	18-5243	380-627	18-5297	383-551
18-4843	102	18-5143	238	18-5244	380-627	18-5298	383-551
18-4850	213	18-5144	247	18-5245	380-625	18-5299	383-551-628-629
18-4851	213	18-5148	132-133	18-5246	378-625	18-5300	380
18-4858-9	199	18-5151	247	18-5247	378-625	18-5301	379-548-626
18-48619	292	18-5152	247	18-5248	548-626	18-5302	379-548-626
18-4904	91	18-5153	130-132-133	18-5250	378-546	18-5303	379-547-625
18-4911	91	18-5156	29	18-5251	378-546	18-5305	625
18-4913	91	18-5157	29-547	18-5253	378	18-5306	625
18-4914	91	18-5163	30	18-5254	378	18-5309-1	386-553

Código	Páginas	Código	Páginas	Código	Páginas	Código	Páginas
18-5311	379-547	18-5406	380-547-626	18-5497-2	386	18-5634	42
18-5312-1	386-553	18-5407	380-547	18-5498-2	387-553-628	18-5636	149
18-5313-1	386-553	18-5408	380-547-626	18-5511	138	18-5640	41
18-5314	379-547-625	18-5411	548-626	18-5512	387	18-5642	148
18-5315-1	386-553	18-5413	548-626	18-5513	387	18-5648	42
18-5316-1	387-553	18-5418	380-548	18-5514	387	18-56481	351
18-5317	379	18-5419	548-626	18-5518	387	18-5650	150
18-5318	379	18-5420	380	18-5519	387	18-5655	43
18-5319	625	18-5425	626	18-5520	387	18-5656	150
18-5338	379-547-625	18-5428	626	18-55500	373	18-5657	632
18-5339-1	387-553	18-5431	380	18-55501	373	18-5658	150
18-5342	625	18-5432	380	18-55502	373	18-56601	373
18-5344	380-547	18-5433	133-382-549-627	18-55503	373	18-56602	373
18-5345	380-547-625	18-5436	627	18-55600	373	18-5671	43
18-5346	380	18-5437	549-627	18-55601	374	18-5674	43-150
18-5347	380-547	18-5438	382	18-55602	374	18-5678	43
18-5348	625	18-5442	382	18-55603	374	18-5679	43
18-5349	625	18-5443	382-549-627	18-56000	373	18-56870	350
18-5350	385	18-5464	382-548-627	18-56001	240	18-5697	43-150
18-5351	385	18-5465	382	18-56002	240-271	18-5700	641
18-5352	380-548-626	18-5466	344-381-549-627	18-56004	271	18-5704	641
18-5353	380-548-626	18-5467	627	18-56005	271	18-5705	38-561-641
18-5354	380-548-626	18-5469	344-381-549-627	18-56006	271	18-5707	143
18-5356	626	18-5470	385	18-56007	271	18-5708	40
18-5357	626	18-5471	385	18-5601	148	18-5709	40
18-5358	626	18-5472	344-381-549-627	18-5602	148	18-5711	561
18-5361	380-548-626	18-5473	346-381-548-626	18-5603	399	18-5717	402-559
18-5362	380-548-626	18-5474	346-381-548-626	18-5605	148	18-5729	144
18-5369	380-548-626	18-5475	385-553-628	18-5606	148	18-5731	249
18-5375	548-626	18-5476	385-552-628	18-5608	149	18-5732	143
18-5376	381-548	18-5477	345-384-551-628	18-5609	147	18-5737	144
18-5384	381-548	18-5478	345-384-552-629	18-5610	149	18-5740	406
18-5385	381-548	18-5479	345-384-552-629	18-5611	149	18-5741	143
18-5386	381-548	18-5480	345-384-551-628	18-5612	42	18-5743	143
18-5389	381	18-5481	345-384-551	18-5617	42	18-5745	627
18-5393	626	18-5482	345-384-551	18-5619	42	18-5746	269
18-5395	381	18-5483	346-384-551-628	18-5620	149	18-5750	15-36-138-238-247-267-398-555-632
18-5396	381	18-5484-1	385-553-628	18-5621	149	18-5750-9	15-36-138-238-247-267-398-555-632
18-5397	381-548	18-5486-2	385-552	18-5624	42	18-5752	15-36-138-238-247-267-398-555-632
18-5399	381-591	18-5487-2	386-552	18-5627	42	18-5753	32
18-5399-9	381-591	18-5488	382	18-5628	42	18-5754	32
18-5402	380-625	18-5489-2	386-552	18-5629	42	18-5755	32
18-5403	380-547-625	18-5494-2	386-552-628	18-5630	42	18-5756	32
18-5404-1	380-547-625	18-5495-2	386-552	18-5631	42	18-5757	32
18-5405	380-547-625	18-5496-2	386-552	18-5632	42	18-5758	32

Código	Páginas	Código	Páginas	Código	Páginas	Código	Páginas
18-5759	32	18-5810	143-403	18-5872	404	18-5959	638
18-5760	32	18-5811	143-403-559-640	18-5873	140	18-5960	405
18-5761	32	18-5812	559	18-5874	141	18-5965	405
18-5762	32	18-5813	38	18-5876	141	18-5966	405
18-5763	32	18-5814	38-559	18-5877	37	18-5967	405
18-5764	32	18-5815	143-403	18-5878	37	18-5968	406
18-5765	33	18-5816	143-403	18-5879	269	18-59700	638
18-5766	33	18-5817	143-403	18-5881	134	18-59710	638
18-5767	33	18-5818	143	18-5882	638	18-5979	638
18-5768	33	18-5819	143-269	18-5883	33	18-5982	361
18-5770	33	18-5820	143-403	18-5884	34	18-5983	405
18-57702	664	18-5821	143-269	18-5885	34	18-6000A	678
18-57703	373	18-5822	143	18-5886	34	18-6004A	678
18-57704	373	18-5823	38	18-5887	34	18-6009A	678
18-5771	33	18-5825	40	18-5888	549	18-60103	244
18-5772	33	18-5826	40	18-5889	549	18-60103-50	244
18-5773	33	18-5827	40	18-5890	549	18-6010A	678
18-5774	33	18-5828	40	18-5891	34	18-6011	216
18-5775	134	18-5829	40	18-5893	34	18-6011A	24-216-536
18-5776	134	18-5830	40	18-5894	571-649	18-6014	216
18-5777	134	18-5831	40	18-5896	167	18-6014A	216-536
18-5778	134	18-5832	40	18-5897	442-575-649	18-60151-9	536
18-5780	33	18-5833	38	18-5898	442-575	18-6015A-9	536
18-5781	33	18-5834	144	18-5899	442-575-649	18-6016	216
18-5782	33	18-5836	144-403	18-5903	401-558-637	18-60161	216-536
18-5783	33	18-5837	402-559-640	18-5906	637	18-60161-9	216-536
18-5784	33	18-5838	402-559	18-5907	399-557	18-6016A	216-536
18-5785	33	18-5840	402	18-5908	400-558	18-6017A	116
18-5786	134	18-5849	144	18-5910	400-558	18-6021	679
18-5788	134	18-5850	144	18-5911	399-557-637	18-6024	116
18-5790	134	18-5851	144	18-5913	400-558-637	18-6024A	610
18-5791	134	18-5852	144	18-5917	558	18-6025	116-610
18-5792	134	18-5853	269	18-5919	400-557-637	18-6028A	611-678
18-5793	134	18-5854	141	18-5920	557-637	18-6029	611
18-5794	33	18-5856	141	18-5923	399-557-637	18-6032	258
18-5796	141	18-5857	141	18-5927	557-637	18-6033	258
18-5797	141	18-5859	141	18-5929	147	18-6034	317
18-5798	141	18-5860	141	18-5939	639	18-6035	317
18-5801	38-402-559	18-5863	140	18-5943	639	18-60508	311
18-5802	143-402	18-5864	140	18-5945	405	18-60512	315
18-5803	559	18-5865	140	18-5946	405	18-60513	315
18-5804	402	18-5866	140	18-5949	406	18-60519	315
18-5806	640	18-5867	140	18-5953-1	406	18-60520	315
18-5807	38-559	18-5870	140	18-5956	405	18-60521	315
18-5808	38-143-559	18-5871	140	18-5957	405-561-638	18-60522	315

Código	Páginas	Código	Páginas	Código	Páginas	Código	Páginas
18-60523	315	18-6118A	317	18-6158A	536	18-6276	557
18-60527	315	18-6119A	317	18-6158M	536	18-6277	37
18-60528	315	18-6119Z	317	18-6158Z	536	18-6280	37
18-60529	315	18-6120A	317	18-6159A	536	18-6281	37
18-60530	315	18-6120Z	317	18-6159M	536	18-6282	148
18-60531	315	18-6121A	317	18-6159Z	536	18-6283	148
18-60532	315	18-6121Z	317	18-6160A	536	18-6285	37
18-60534	315	18-6122A	317	18-6160M	536	18-6291	559-640
18-60535	315	18-6122Z	317	18-6160Z	536	18-6293	405
18-60540	315	18-6123Z	678	18-6161A	258	18-6298	405
18-60541	315	18-6124Z	678	18-6161M	258	18-6350	513
18-6066A	536	18-6125A	678	18-6162A	317	18-6350K	512
18-6067A	537	18-6125M	678	18-6162M	317	18-6351	513
18-6068	216	18-6125Z	678	18-6163A	24	18-6351K	512
18-6079	537	18-6126A	678	18-6163M	24	18-6352	513
18-6080A	537	18-6126M	678	18-6165A	24	18-6352K	512
18-6089	537	18-6126Z	678	18-6200	374	18-6353	513
18-6091	317	18-6127A	678	18-6201	374	18-6353K	512
18-60915	193-244	18-6127M	678	18-6240	537	18-63966	315
18-60916	191-244	18-6127Z	678	18-6241	24-216-536	18-63968	315
18-60917	195-244	18-6128A	679	18-6242-9	536	18-6399	599
18-60918	197-244	18-6128M	679	18-6243	536	18-6400	514
18-60919	197-244	18-6128Z	679	18-6244	216-536	18-6401	515
18-60920	197-244	18-6129A	679	18-6245	217	18-6402	515
18-6092A	537	18-6129M	679	18-6246	317	18-6403	514
18-6093A	537	18-6129Z	679	18-6249A	217	18-6405	514
18-6094A	537	18-6130	679	18-6250	43-150	18-6406	515-676
18-6095	611	18-6131	679	18-6251	43-150	18-6410	269
18-6095A	116-611	18-61319	494	18-6252	37	18-6411	269
18-6099	537	18-6132A	317	18-6253	404	18-6412	270
18-6100	116	18-6132M	317	18-6254	404	18-6413	270
18-6101	611	18-6133A	317	18-6255	404	18-6414	248
18-6102	611-678	18-6133M	317	18-6256	404	18-6415	270
18-6103	611	18-6150A	537	18-6257	561	18-6416	248
18-6103A	611	18-6150M	537	18-6258	16	18-6417	248
18-6104	678	18-6150Z	537	18-6259	274	18-6418	239
18-6105	678	18-61513	490	18-6260	561	18-6419	248
18-61051	382	18-6154A	536	18-6261	561-638	18-6420	270
18-6106	678	18-6154M	536	18-6266	641	18-6421	270
18-6111	317	18-6154Z	536	18-6268	641	18-64217	191
18-6112	317	18-6155Z	611	18-6270	557	18-6422	270
18-6114	537	18-6156A	216	18-6271	641	18-64221	191-243
18-6117A	536	18-6156M	216	18-6273-1	139	18-6423	270
18-6117M	536	18-6157A	216	18-6274	140-642	18-6425	148-270
18-6117Z	536	18-6157M	216	18-6275	399-637	18-6426	270

Código	Páginas	Código	Páginas	Código	Páginas	Código	Páginas
18-6427	270	18-6755	561	18-6813	404	18-6931	362
18-6430	239	18-6756	37	18-6814	562	18-6932	362
18-6431	239	18-6757	139	18-6815	37	18-6934	362
18-6432	239	18-6758	642	18-6816	147	18-6935	362
18-6433	16	18-6759	37	18-6817	641	18-6936	362
18-6434	41	18-6760	274	18-6821	274	18-6937	362
18-6435	147	18-6761	37	18-6822	641	18-6938	362
18-6436	148	18-6762	37	18-6823	16-37-239-249-274-404-562-641	18-6939	362
18-6437	148	18-6763	139-404	18-6824	149	18-6940	150
18-6438	148	18-6764	562	18-6825	149	18-6942	270
18-6440	148	18-6765	139	18-6826	43	18-6943	150-270
18-64415	313	18-6767-1	37	18-6827	248	18-6944	362
18-6445	16	18-6768	404	18-6828	149	18-6946	401
18-6448	140-240	18-6769-1	404	18-6829	149	18-6947	362-401
18-6454	147	18-6770	641	18-6832	270	18-6948	362-406
18-6455	147	18-6771	138-404	18-6833	270	18-6949	362-401
18-6456	675	18-6772	404	18-6834	346-637	18-6950	562
18-6457	430	18-6773	139	18-6835	346-638	18-6950-9	562
18-6475	16	18-6774	139	18-6836	274	18-6951	641
18-6476	16	18-6775	139	18-6837	249	18-6951-9	641
18-6500	147	18-6777	139	18-6838	641	18-6952	361
18-6501	91	18-6778	139-404	18-6839	638	18-6953	361-639
18-6503	91	18-6779	562-642	18-6840	147	18-6954	362
18-6506	200	18-6780	37	18-6841	405-561	18-6955	361-639
18-6509	91	18-6781	274	18-6842	346-405	18-69550	640
18-6511	91	18-6782	274	18-6844	405	18-6956	638
18-6512	91	18-6783	274	18-6845	639	18-6957	362-401
18-6512-9	91	18-6785	249	18-6846	361-639	18-6958	362-638
18-6513	91	18-6786-1	249	18-6847	639	18-6959	16
18-6513-9	91	18-6787	274	18-6848	639	18-6960	406
18-6522	91	18-6788	274	18-6849	361	18-6961	271
18-6523	676	18-6789	274	18-6861	270	18-6970	361
18-6525	114	18-6790	642	18-6863	43	18-6971	361
18-6526	114	18-6791	642	18-6864	149	18-6975	346-405-639
18-6527	114	18-6792	642	18-6865	16-37-239-249-274	18-7000	643
18-6528	114	18-6793	16-249	18-6870	361-401	18-7001	643
18-65450	267	18-6798	271	18-6872	361-638	18-7002	275
18-6747	403	18-6799	404	18-6880	362	18-70021	446-576-653
18-6748	271	18-6801	38	18-6881	641	18-7004	151
18-6749	403	18-6802	38	18-6925	361	18-7005	151
18-6750	403	18-6803	38	18-6926	361	18-7006-1	151
18-6751	138	18-6804	641	18-6927	361	18-7007	152
18-6752	403	18-6806	641	18-6928	361	18-7008	643
18-6753	403	18-6811	274	18-6929	361	18-7010	44
18-6754	561	18-6812	274	18-6930	362	18-7013	152

Código	Páginas	Código	Páginas	Código	Páginas	Código	Páginas
18-7017	564	18-7081	418-564	18-7102	225-617	18-7146	225-541-617
18-7018	564	18-7083	161	18-7103	225-541-617	18-7150	617
18-7021	152	18-7085	643	18-7104	617	18-7151	225-541
18-7024	44	18-7086	564-643	18-7105	225-541-617	18-7152	225-541-617
18-7026	44	18-70924	446-576-653	18-7106	45	18-7153	225-541-617
18-7038	45	18-70925	445	18-7106-9	45	18-7155	225-541-617
18-7040	643	18-70926	445	18-7107	225-541-617	18-7156	225-541-617
18-7042	44	18-70927	445	18-7108	617	18-7157	225-541
18-7043	44	18-70928	445	18-7109	617	18-7158	225-541-617
18-7044	45	18-70929	445	18-7110	82	18-7159	225-541
18-7046	44	18-7093	45	18-7110-9	82	18-7160	225-541
18-7047	19	18-70930	446	18-71102	111	18-7161	225-541
18-7048	19	18-70931	446	18-7111	617	18-7162	225-541-617
18-7049	276	18-70932	446	18-7112	617	18-7163	225-541
18-7050	19	18-70933	444	18-7113-9	166	18-7164	225-541-617
18-7051	19	18-70934	444	18-7114	225-541-617	18-7165	225-541-617
18-7052	19	18-70935	444	18-7115	225-541-617	18-7166	225-541
18-7053	19	18-70936	76	18-7116	225-541-617	18-7167	225-541-617
18-7054	276	18-70937	76	18-7117	225-541-617	18-7168	225-541-617
18-7055	276	18-70938	444	18-7118	260-617	18-7169	225-541-617
18-7056	277	18-70939	444	18-7119	334	18-7170	225-541-617
18-7057	153	18-7094	45	18-7120	225-541-617	18-7171	225-541
18-7058	275	18-70940	444	18-7121	225-541-617	18-7172	225-541-617
18-7059	275	18-70943	445	18-71218	446-576-653	18-7173	225-541-617
18-7060	277	18-70945	443	18-7123	617	18-7174	225-541-617
18-7061	153	18-70946	444	18-7124	225	18-7175	225-541
18-7062	153	18-70947	443	18-7125	225	18-7176	225-541
18-7063	277	18-70948	443	18-7126	617	18-7177	225-541
18-7064	277	18-70949	443	18-7127	541-617	18-7178	617
18-7065	277	18-7095	418-564-643	18-7128	617	18-7180	225-541-617
18-7066	277	18-70950	444	18-7129	617	18-7188	225-541
18-7067	277	18-70951	443	18-7130	617	18-7198	25-541-617
18-7068	277	18-70952	443	18-7133	617	18-7198-9	25
18-7069	277	18-70953	443	18-71337	446-576-577-653	18-7200	419-566-644
18-7070	417-564	18-70954	443	18-7134	541-617	18-72000	153
18-70704	446-576-653-653	18-70955	443	18-7135	225-541-617	18-72005	530
18-7071	417-564	18-70956	443	18-7137	617	18-7201	419-566-644
18-7072	418-564-643	18-70957	444	18-7138	617	18-7202	419-644
18-7073	277	18-70958	444	18-7139	617	18-7206	566
18-7075	417	18-7096	418-565	18-7140	260-617	18-7208	153
18-7076	418	18-7097	418	18-7141	617	18-7209	153
18-7077	418	18-7098-1	418	18-7142	617	18-7210	45
18-7078	418	18-7099	644	18-7143	225-541-617	18-7211-1	152
18-7079	277	18-7100	225-617	18-7144	617	18-7212	152
18-7080	418-564	18-7101	617	18-7145	225-541-617	18-7213	152

Código	Páginas	Código	Páginas	Código	Páginas	Código	Páginas
18-7214	152	18-7288-1	423	18-73893	317	18-74507	333
18-7215	152	18-7289	567	18-7390	279	18-74510	333
18-7216	152	18-7290	152-242-275	18-7391	279	18-74512	333
18-7219	44	18-7291	152-242-275	18-73914	317	18-74515	333
18-7221	44	18-7293	152-275	18-73918	317	18-74527	333
18-7222	44	18-7295	153	18-7392	277	18-74535	333
18-7223	45	18-7296	45	18-7393	277	18-74540	333
18-7226	152	18-7296-9	45	18-73964	244	18-74544	333
18-7227	419	18-7300	675	18-73978	317	18-74546	333
18-7228	422	18-7306	675	18-73979	317	18-7457	617
18-7229	422-567-645	18-73131	516	18-73990	317	18-7459	225-541
18-7230	422	18-7321	520	18-73993	317	18-7461	617
18-7231	422	18-7321-9	520	18-73994	318	18-74610	243
18-7232	346-422	18-7326	423-568-645	18-7400	191-617	18-74611	243
18-7233	153	18-7330	568-645	18-7400-9	191	18-7463	334
18-7234	422	18-7331	568-645	18-7401	617	18-7464	225-541
18-7235	565	18-7332	347	18-7403	617	18-7467	225-541
18-7236	565	18-7334	279	18-7404	617	18-7468	334
18-7237	565-643	18-7340	279	18-7406	617	18-7469	334
18-7238	565-643	18-7341	279	18-7407	617	18-7470	334
18-7239	565	18-7342	279	18-7408	617	18-7474	225-541
18-7241	565-643	18-7343	279	18-7409	617	18-7475	617
18-7242	565-643	18-7349	279	18-74108	119	18-7477	617
18-7243	565	18-7350	47	18-7411	225-541	18-74805	220-243
18-7244	565-644	18-7351	47	18-7413	225-541-617	18-7481	89
18-7245	565-644	18-7352	47	18-7414	225-541	18-7481-9	89
18-7246	565-644	18-7353	47	18-7415	225-541	18-7483	334
18-7247	45	18-7354	151	18-7416	617	18-7484	274
18-7248	45	18-7355	151	18-7417	617	18-7485	334
18-7249	153	18-7356	151	18-7418	617	18-7486	283
18-72510	530	18-7367	280	18-7419	225-541	18-7487	283
18-7256	567	18-7368	280	18-7420	225-541	18-7488	283
18-7265	567	18-7369	280	18-7421	225-541	18-7489	348
18-72656	244	18-7370N	413	18-7426	225-541	18-7492	627
18-7266	423	18-7373N	413	18-7428	89	18-7493	382-627
18-7267	423-567	18-7375N	413	18-7428-9	89	18-7494	15
18-7268	567-645	18-7376N	413	18-7432	334	18-7508	478
18-7274	423	18-7380	135	18-7436	334	18-7510	617
18-7275	423	18-7381	153	18-7440-1	225-541-617	18-75100	446-576-577-653
18-7278	423-567	18-7382	153	18-7442	334	18-75125	446-576-577-653-653
18-7281	645	18-7388	279	18-7444	334	18-7513	649
18-7282	423	18-7389	279	18-7445	225-541	18-7550	409
18-7283	423	18-73890	216-244	18-7449	225-541	18-7551	410
18-7284	423	18-73891	317	18-74501	220-333	18-7552	19
18-7286	645	18-73892	318	18-74504	333	18-7553	410

Código	Páginas	Código	Páginas	Código	Páginas	Código	Páginas
18-7554	410	18-7663	409	18-7717	429-571-649	18-7775-1	49-163-281-427-569-646
18-7556	382	18-7664	419	18-7718	165	18-7776	50-163-281-346-426-568-646
18-7558	19	18-7665	419	18-7719	51-250	18-7776-1	49-163-281-427-569-646
18-7559	19	18-7666	419	18-7720	16	18-7777	50-163-281-426-568-646
18-7600	409	18-7667	419	18-7721	429	18-7777-1	49-163-281-427-569-646
18-7601	562-649	18-7668	410	18-7722	51	18-7778	647
18-7603-1	413	18-76689	334	18-7727	565	18-7780	283
18-7604-1	413	18-76690	334	18-7728	418	18-7781	283
18-7605-1	413-563	18-76691	334	18-7729	565	18-7782	283
18-7606	286	18-76692	334	18-7730	565	18-7783	373
18-7608-1	413-563	18-76693	334	18-7735	250	18-7784	429
18-7609-1	413-563	18-76694	334	18-7736	275	18-7785	16
18-7610-1	413	18-76695	225-244	18-7737	275	18-7786	16
18-7611-2	413	18-7677	410-562-649	18-7738	152-275	18-7787	279
18-7613-1	413	18-7679	562-649	18-7739	275	18-7788	279
18-7615-1	413-563	18-7682	409	18-7740	275	18-7789	570-647
18-7615N	413-563	18-7683	409	18-7741	275	18-7790	347
18-7616-1	413	18-7684	409-562-649	18-7742	275	18-7792	570-648
18-7617-1	413	18-7685	410-649	18-7743	152-275	18-7796	48
18-7618-1	414	18-7688	410	18-7744	275	18-7796-9	48
18-7619-1	414	18-7689	562-649	18-7746	418	18-7797	280
18-7627	348	18-7690	411	18-7747	275	18-7798	280
18-7628	348	18-7691	411	18-7748	418	18-7799	280
18-7630	409	18-7692	411	18-7749	418	18-7800	47
18-7632	409	18-7693	411	18-7750-1	153	18-7801	47
18-7633	534	18-7694	411	18-7751	346-417	18-7802	165
18-7634	611	18-7695	411	18-7752	250	18-7804	157
18-7635	563	18-7696	411	18-7753	250	18-7806-1	157
18-7636	563	18-7697	409	18-7754	250	18-7807	157
18-7637	346-563	18-7698	410	18-7755	250	18-7808	157
18-7638	346-563	18-7700	409-649	18-7756	275	18-7809	157
18-7639	413	18-7701	409	18-7757	410-627	18-7810	157
18-7640	413-563	18-7702	442-649	18-7758	186	18-7811	157
18-7641	642	18-7703	410-562-649	18-7759	275	18-7812	157
18-7642	382-627	18-7704	649	18-7761	44-249	18-7813	157
18-7643	627	18-7705	649	18-7765	153-242-275	18-7814	157
18-7646	410	18-7706	627	18-7766	276	18-7815	157
18-7647	649	18-7708	627	18-7767	276	18-7817	157
18-7648	382-627	18-7709	648	18-7768	276	18-7818-1	157
18-7655	286	18-7710	283	18-7769	153-276	18-7820	47
18-7656	286	18-7711	250	18-7770	153-276	18-7821	47
18-7657	19	18-7712	18-165-240	18-7772	276	18-7822	47
18-7658	19	18-7713	165-283	18-7773	44-249	18-7823	48
18-7659	19	18-7714	165	18-7774	50-164-282-428-570-647	18-7824-1	477-586-664
18-7660	409	18-7716	51-250	18-7775	50-281-346-568	18-7824C-1	347

Código	Páginas	Código	Páginas	Código	Páginas	Código	Páginas
18-7826	51	18-7895	76-257	18-7946	51-570-647	18-79912	164
18-7828-1	51-130-240-283	18-7896	76-257	18-7947	16-250-282-428-570-648	18-7994-1	164
18-7829	51-130-240-283	18-7897	76-257	18-7948	16-250-282-428-570-648	18-79950	285
18-7830	51-130-240-283	18-7898	280	18-7949	282-428-570-648	18-79951	285
18-7831	51-130-240-283	18-79007	649	18-7951	50-164-282-428-569-647	18-79952	285
18-7832	165	18-7901	186-302	18-7953	51-250	18-79953	285
18-7833	157-280	18-7902	302	18-7954	301-302	18-79954	285
18-7834	157-280	18-7903	76-257	18-7955	283	18-79955	285
18-7837	157-280	18-7905	257	18-7956	225	18-79956	285
18-7838	157	18-7906-1	186-302	18-7961	225-541	18-79957	285
18-7839	157-280	18-7907	664	18-7963	90	18-79960	370
18-7840	157-280	18-7908	664	18-7964	429-571-649	18-79961	301
18-7841	280	18-7909	23	18-7965-1	50-164-282-428-570-647	18-7997	166
18-7842	280	18-7910-1	375	18-7966-1	50-164-281-569-646	18-79970	283
18-7843	280	18-7911-1	23-243-301	18-7967	164	18-79971	301
18-7844	164-282-570-647	18-7913	23-186	18-7968	164	18-79972	283
18-7845	164-282-570-647	18-7914	186	18-7969	164-428	18-79973	283
18-7846	570-647	18-7915-1	76-257	18-7970	370	18-79974	301
18-7847	157	18-7916	76	18-7974	664	18-79975	301
18-7848-1	49-163-281-427-569-646	18-7917	375	18-7977	429	18-79976	301
18-7848-2	49-163-281-427-569-646	18-7918	186	18-79781	51	18-79977	284
18-7852-1	49-130-163-281-427-569-646	18-7919	51-164-282-428-429-570-648	18-7979	165-283	18-79978	285
18-7852-2	163-281-427-569-646	18-7920	51-164-282-428-570-648	18-79799	283	18-79979	284
18-7853-1	50-281-568	18-7921	186	18-79809	283	18-79980	284
18-7854	570	18-7922-1	51-164-250-282	18-7981	165	18-79981	284
18-7855	429-570	18-7924	51-164-282-428-570-648	18-7982-1	50-164-281-569-646	18-79982	284
18-7858	370-648	18-7925	375	18-7982-2	50-164-281-569-646	18-79983	284
18-7859	429-571-648	18-7926	375	18-7983-1	50-164-281-569-646	18-79984	284
18-7860	429-571	18-7927	375	18-7983-2	50-164-281-569-646	18-79985	284
18-7861	571	18-7928-1	51-164-282	18-7984-1	50-164-281-569-646	18-79986	284
18-7862	571-648	18-7929	51-164-283-428-570-648	18-7985-1	50-164-281-569-646	18-79989	24-111-130-216-244-258-318
18-7865	51-164-282-428-570-647	18-7930	570	18-7986-1	50-164-281-569-646	18-7999	166
18-7866	51-164-282-347-428-570-647	18-7931	370	18-7987	250	18-79993	642
18-7869	429	18-7932-1	50-164-282	18-7989	51-570-647	18-79994N	414
18-7871	374-477	18-7934	370	18-79900	284	18-79995N	414
18-7873	370-429	18-7935	370	18-79901	284-429	18-79996	414
18-7875	477-586	18-7936	165-250	18-79902	285	18-79997	414
18-7876	477-586-664	18-7937-1	50-164-282	18-79903	285	18-79998	642
18-7878-1	477-586-664	18-7938	50-164-282-428-569-647	18-79904	285	18-80005	642
18-7879-1	477-586-664	18-7941-1	51-570	18-79905	283	18-80006	563-642
18-7880	375-664	18-7942	370-648	18-79907	284	18-80007	642
18-7884	375-664	18-7943	51-428-570	18-79908	18	18-80008	563-642
18-7886	375	18-7944	51-164-282-428-570-647	18-79909	18	18-80009	563-642
18-7888	650	18-7945	51-164-282-428-570-647	18-79910	285	18-8002EP-1	18-130-160-242-251-287
18-7890	664	18-7945C	347	18-79911	164-428	18-8002EP-1-10	18-160-242-251-287-287

Código	Páginas	Código	Páginas	Código	Páginas	Código	Páginas
18-8003	664	18-80425	251	18-8200	54-571-650	18-8359	680
18-8004-10EP-1	52-251	18-8048	52	18-8201	54-571-650	18-8360	610
18-8004EP-1	18-52-130-160-242-251-287	18-8050	52	18-8202	54-571-650	18-8361	680
18-8004EP-1-10	18-160-242-287	18-8051	52	18-8203	54-571-650	18-8362-1	25
18-8004PE-1	130	18-8052	52	18-8204	54-571-650	18-8363	25
18-8005-10EP-1	52	18-8054	160	18-8205	518	18-8365	25
18-8005-10PE-1	251	18-8055	52-160-287-571	18-8206-1	518	18-8366	25
18-8005EP-1	18-52-130-159-160-242-251-286-287	18-8056	52	18-8208	538	18-8368	676
18-8005EP-1-10	18-160-242	18-8056-10	52	18-8212-1	518	18-8369	595
18-8009EP-1	52	18-8062	253	18-8213	518	18-8370	538
18-8010EP-1	159	18-8063	52	18-8216	473-582	18-8372	90
18-8012EP-1	159	18-8063-1	52	18-8217	518	18-8373	259
18-8013EP-1	130	18-8068	159-160-161	18-8218	518	18-8374	259
18-8014EP-1	52	18-8069	161	18-8219	518	18-8375	260
18-8015EP-1	130	18-8070	161	18-8220	406	18-8377	260
18-8016EP-1	160	18-8071	253	18-8226	18	18-8378	260
18-8017EP-1	286	18-8072	52-571	18-8227	478	18-8380	258
18-8020	54-242-571-650	18-8073	159-160	18-8297	478	18-8381	258
18-8020-9	242	18-8074	52-159-160-571	18-8298	23	18-8382	220
18-8021	54-242-571-650	18-8075	161	18-8299	23	18-8383	119
18-8021-9	242	18-8076	159-160-161-286	18-8304	105	18-8384	119
18-8024EP-1	159	18-8076-10	161	18-8305	200	18-8385	260
18-8025EP-1	160	18-8077-1	161-286-287	18-8308	222	18-8386	260
18-8032EP-1	130	18-8077-1-10	161-287	18-8309	200	18-8387	119
18-8034	54-571-650	18-8078	242-253	18-8310	222	18-8400-9	289
18-8040	287	18-8079	242-253	18-8311	515	18-8402	402
18-80400	18	18-8082	159-160-161	18-8312	515	18-8403	402
18-80401	18	18-8083	159-161	18-8313	515	18-8404-1	402
18-80402	160-161	18-8084	159-160-161	18-8331	258	18-8410	470
18-80403	18	18-8085	161	18-8331-9	258	18-8411	470
18-80404	253	18-8085-10	161	18-8334	258	18-8412	401-559
18-80405	253	18-8087	253	18-8335	259	18-8500	470
18-80406	18	18-8088	242	18-8337	119-259	18-8502	583-658
18-80407	18	18-8089	242	18-8338	259	18-8505	470
18-80408	18	18-8090	253	18-8339	259	18-8507	583-658
18-80409	251	18-8091	160-161	18-8340	259	18-8508	470
18-80410	161-242	18-8092	52	18-8341	259	18-8510	658
18-80412	161	18-81042EP-1	18	18-8345	260	18-8511	658
18-80413	287	18-8111	470	18-8347	222	18-8512	470
18-80414	287	18-8114	347-417-567-644	18-8349	615	18-8514	470
18-80415	287	18-8115	347-417-567-644	18-8352	84	18-8520	470
18-80417	242	18-8124	370-648	18-8353	90	18-8529	471
18-80418	251	18-8125	370-648	18-8355	75	18-8530	471
18-80419	251	18-8126	370-648	18-8357	680	18-8531	471
18-80420	18	18-8149	648	18-8358	680	18-8532	471

Código	Páginas	Código	Páginas	Código	Páginas	Código	Páginas
18-8533	471	18-8921	242	18-99008	308	18-99063	309
18-8534	583	18-8922	242	18-99009	308	18-99064	310
18-8535	471-583-658	18-8923	242	18-99010	308	18-99066	310
18-8536	471-583-658	18-8924	242	18-99012	308	18-99067	310
18-8538	471-583-658	18-8925	288	18-99013	308	18-99068	310
18-8539	658	18-8950	373	18-99014	308	18-99069	310
18-8548	471	18-8951	373	18-99015	308	18-99070	310
18-8549	471	18-8952	373	18-99016	308	18-99071	310
18-8551	471	18-8953	282	18-99017	308	18-99072	310
18-8553	583	18-8954	282	18-99018	308	18-99073	302
18-8554	471	18-8955	165-429	18-99019	308	18-99074	310
18-8555	471	18-8956	157	18-99020	308	18-99075	310
18-8556	471	18-8957	157	18-99021	308	18-99076	310
18-8700	302	18-8958	157	18-99022	308	18-99078	310
18-8801-1	630	18-8962	351	18-99023	308	18-99079	310
18-8802-1	630-631	18-8963	351	18-99024	308	18-99080	310
18-8813-1	630-631	18-8964	663	18-99025	308	18-99081	310
18-8815-1	35	18-9010	216-533	18-99026	308	18-99082	310
18-8816-1	35	18-9075	216-291	18-99027	308	18-99083	310
18-8818-1	35	18-9076	216-291	18-99028	308	18-99084	310
18-8820-1	631	18-9077	216-291	18-99030	309	18-99085	310
18-8823-1	630	18-9078	216-291	18-99032	309	18-99086	310
18-8828-1	631	18-9079	216-291	18-99033	309	18-99087	310
18-8829-1	631	18-9096	675	18-99034	309	18-99088	310
18-8833-1	631	18-9098	609-675	18-99037	309	18-99089	311
18-8835-1	631	18-9099	533	18-99038	309	18-99091	311
18-8836-1	631	18-9125	54	18-99039	309	18-99092	302
18-8838-1	631	18-9145	287	18-99040	309	18-99093	302
18-8839-1	35	18-9218	515	18-99045	309	18-99094	305
18-8840-1	35	18-9219	108	18-99046	309	18-99095	311
18-8860	423	18-9240-0	523	18-99047	309	18-99096	311
18-8861	422	18-9240-1	523	18-99048	305	18-99097	302
18-8862	422	18-97101	684	18-99049	309	18-99098	311
18-8864	422	18-9800	140	18-99050	309	18-99099	311
18-8865	422	18-9801	140	18-99051	309	18-99100	311
18-8866	157	18-9803	523	18-99052	309	18-99101	311
18-8867	422	18-9806E	520	18-99053	309	18-99102	311
18-8868	423	18-9876	598	18-99054	309	18-99103	302
18-8870	257	18-99000	307	18-99055	309	18-99104	302
18-8898	344	18-99001	307	18-99056	309	18-99105	311
18-8899	344	18-99002	307	18-99057	309	18-99106	311
18-8900	168	18-99003	307	18-99059	305	18-99107	311
18-8910	288	18-99004	307	18-99060	305	18-99108	311
18-8911	288	18-99005	307	18-99061	302	18-99109	311
18-8920	242	18-99006	307	18-99062	305	18-99110	311

Código	Páginas	Código	Páginas	Código	Páginas	Código	Páginas
18-99111	311	262LD	340	62BHSX	711	62M300181419	701
18-99112	311	262LE	340	62BHTC	711	62M300183417	701
18-99113	311	262LF	340	62BHTC48	711	62M40101213	704
18-99114	311	262LG	340	62BHTD	711	62M40101414	704
18-99115	311	262LI	340	62BHYC	711	62M40101815	704
18-99116	311	262LJ	340	62BHYD	711	62M40103813	704
18-99117	302	305LA	341	62BHYE	711	62M40103814	704
18-99118	311	305LB	341	62H159141012	707	62M40105812	704
18-99119	311	305LC	341	62H1591412	707	62M55107811	704
18-99120	311	305LE	341	62H159148	707	62M55111410	704
18-99121	312	305LF	341	62H159149	707	62M55121012	704
18-99122	312	350LA	341	62H15914934	707	62M5512149	704
18-99123	312	350LB	341	62H3097810	707	62M57788	703
18-99124	312	350LC	342	62H3097811	707	62PY40111211	702
18-99125	312	350LE	342	62H3097812	707	62PY40113410	702
18-99126	312	350LF	342	62H3097813	707	62S1591410	705
18-99128	312	454LA	342	62H309781414	707	62S1591411	705
18-99129	312	454LB	342	62H309789	707	62S1591412	705
18-99130	312	454LC	342	62H40111414	708	62S159149	705
18-99132	312	454LD	342	62H401115	708	62S15F91410	705
18-99133	312	454LE	342	62H40111813	708	62S15F91411	705
18-99134	312	4U90121219	707	62H40113410	708	62S15F91412	705
18-99135	312	624U150141218	701-703-704-708-710	62H40113812	708	62S15F9149	705
18-99136	312	624U1501420	701-703-704-708-710	62H40115811	708	62S30101410	705
18-99137	312	624U1501516	701-703-704-708-710	62H4012149	708	62S30101411	705
18-99138	312	624U40101814	702-704-705-707-708-709	62J150151213	701-710	62S30101412	705
18-99139	312	624U40101815	702-704-707-708-709	62J150151215	701-710	62S30101413	705
18-99140	312	624U40103813	702-704-705-707-708-709	62J1501517	701-710	62S30101414	705
18-99141	312	624U40105812	702-704-705-707-708-709	62J1591210	708	62S30101415	705
18-99142	312	624U90121219	702-704	62J251013	708	62S3010149	705
18-99143	312	624U90131319	708	62J251015	708	62S40111211	705
18-99144	312	624U901317	702-704-707-708	62J48121213	709	62S40111212	705
18-99145	312	624U90133815	702-704-707-708	62J48121415	709	62S40111213	705
18-99146	278	624U90137811	702-704-707-708	62J70131417	701-709	62S40111214	705
18-99147	312	624U90137813	704-707-708	62J70131419	701-709	62S40111415	705
18-99148	312	62AU40101815	705	62J70133415	701-709	62S401117	705
18-99149	313	62BHHC	711	62J701413	701-709	62S40111816	705
18-99150	313	62BHHD	711	62J701417	701-709	62S60131215	705
18-99151	313	62BHHE	711	62M159147	703	62S60131417	705
18-99152	313	62BHJC48	711	62M1598	703	62S901415	706
18-99175	304	62BHJE	711	62M1599	703	62S901417	706
18-99176	304	62BHMC	711	62M25103811	703	62S901418	706
262LA	340	62BHMD	711	62M25103813	703	62S901419	706
262LB	340	62BHME	711	62M300171223	701	62S901421	706
262LC	340	62BHSJC	711	62M300173421	701	62SX151213	710

Código	Páginas	Código	Páginas	Código	Páginas
62SX151215	710	62U60133415	702-704-707-708	BC88563	38
62SX1517	710	62U601410	702-704-707-708	BC88573	38
62T1591410	706	62U90123421	702-704-707-708	BC88583	38
62T159141012	706	62U90131417	702-704-707-708	BC88593	38
62T1591412	706	62U901319	702-704-707-708	MP28860	267
62T159148	706	62U901411	702-704-707-708	MP28870	36
62T159149	706	62U901413	702-704-707-708	MP28872	36
62T15914934	706	62Y13097813	702	MP28880	36-555
62T3097810	706	62Y150131823	703	MP28890	36-555
62T3097811	706	62Y150133421	703	MP28900	37
62T3097812	706	62Y150141217	703	MP39100	36
62T3097813	706	62Y1501419	703	MP39160	267
62T309781414	706	62Y150151415	703	MP39760	36
62T309789	706	62Y159141012	702	MP39830	36
62T40111414	707	62Y1591412	702	MP41000	138
62T401115	707	62Y159148	702	MP41070-2	138
62T40111813	707	62Y159149	702	MP51010	247
62T40113410	707	62Y15914934	702	MP51012	247
62T40113812	707	62Y309781012	702	MP51020	267
62T40115811	707	62Y309781114	702	MP51022	267
62T4012149	707	62Y3097812	702	MP51030	267
62T88127	706	62Y3097814	702	MP51032	267
62T88128	706	62Y309789	702	MP51040	267
62T90125821	707	62Y40101414	702	MP51042	267
62T90131215	707	62Y40103813	702	MP51050	267
62T90131417	707	62Y40105812	702	MP51052	267
62T901319	707	62Y40111414	702	MP51090	138
62T90135813	707	62Y401115	702	MP51092	138
62U1351517	701-703-708-710	62Y40111813	702	MP52000	138
62U150141219	701-703-704-708-710	62Y40113410	702	MP52002	138
62U150141221	710	62Y401138x12	702	VOL6016	683
62U150141421	701-703-704-708-710	62Y40115811	702	VOL6094	683
62U1501423	701-703-704-708-710	62Y4012149	702	VOL6492	683
62U150151415	701-703-704-710	62Y57127	701	VOL6496	683
62U1501517	704	62Y57128	701	VOL6497	683
62U1501613	701-703-704	62Y60131215	702	VOL6770	683
62U1501616	701-703-704	62Y60135813	702	VOL7200	683
62U40111414	702-704-705-707-708-709	62Y812812	701		
62U40111813	702-704-705-707-708-709	62Y85125821	702		
62U40113410	702-704-705-707-708-709	62Y85131417	702		
62U40113812	702-704-705-707-708-709	62Y851319	702		
62U40115811	702-704-705-707-708-709	BC88523	38		
62U4012149	702-704-705-707-708-709	BC88533	38		
62U48121213	707-709	BC88543	38		
62U48121415	707-709	BC88553	38		



PRONAUTIC

Marine Equipment

Miquel Servet 19, "Polígono Industrial Camí Ral"

08850 Gavà. BARCELONA

T. 936 333 680 - F. 936 625 733

info@pronautic.net

www.pronautic.net

Horarios:

Temporada de verano (Marzo a Septiembre):

9 a 19:00h.

Temporada de invierno (Octubre a Febrero):

9 a 18:00h.

