

ENGINEERING  
YOUR SPRAY SOLUTION

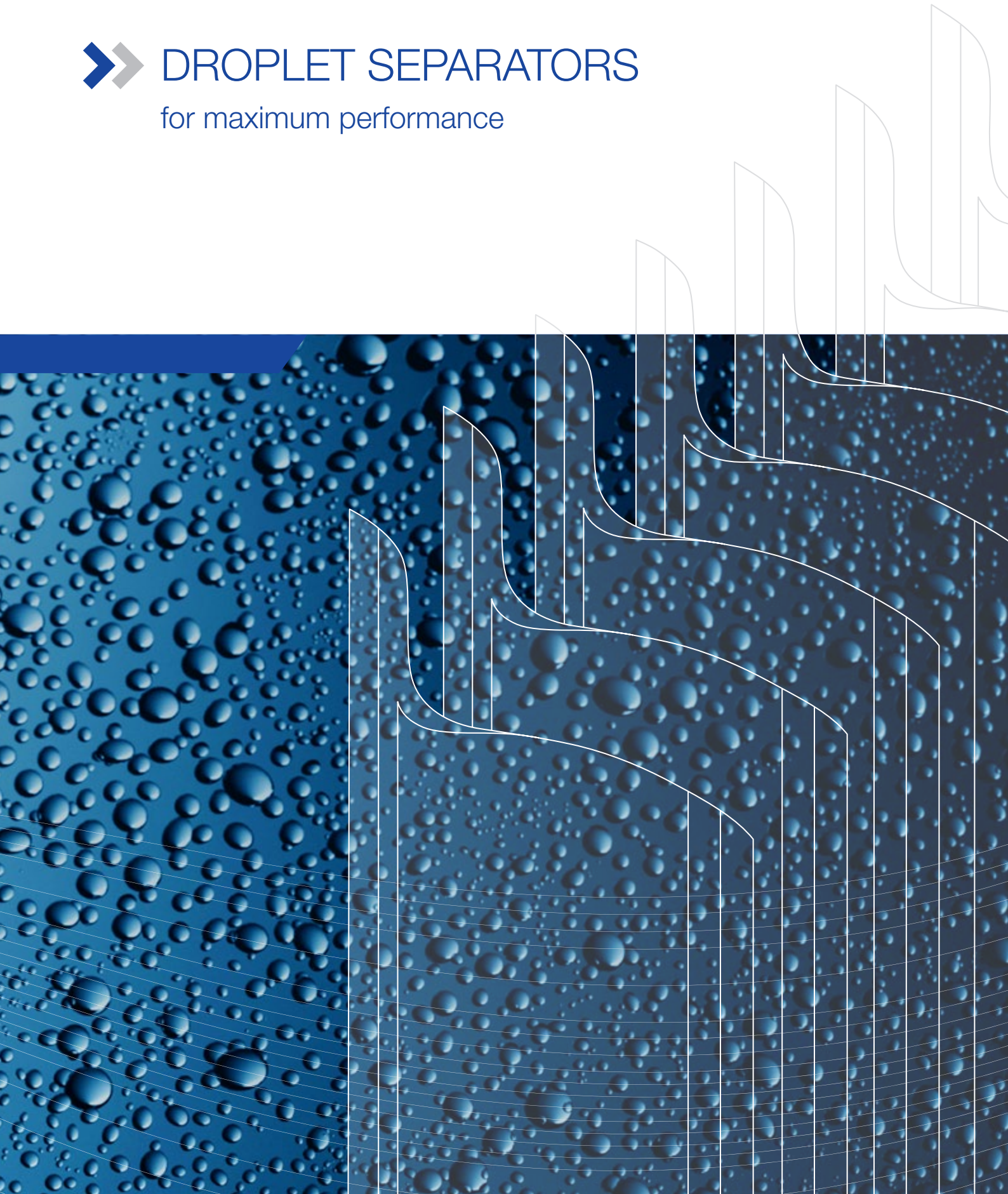

# ➤➤ DROPLET SEPARATORS

for maximum performance





# EVERY DROPLET HAS TWO ENDS WE KNOW BOTH

**A well-designed droplet separator system plays a crucial part in determining the overall efficiency and environmental friendliness of a process. It also minimizes the load on the plant equipment. In order to achieve the best possible results here, it is necessary to perform an in-depth analysis of the droplets – from their production through to separation.**

Lechler is a world-leading supplier of spray nozzles and separator technology. Our products and solutions have been used globally in a very wide range of industries for many decades. We are extremely familiar with the processes involved in all applications where droplets, spray jets and steam play a part.

Based on this knowledge, we have developed a wide range of efficient droplet separators for every purpose. We understand each application has its own specific requirements so we work closely with you to develop the optimum solution. We support you with comprehensive consulting services ranging from process analysis to turnkey solutions – to ensure safe, emissions-compliant and reliable plant operation.

1879



Company founded  
by Paul Lechler

1893



Patent for  
liquid atomization

1967



Relocation of  
production to  
Metzingen

1978



Expansion to the  
USA and then to  
other countries

1988



Droplet Separators  
division founded

1995



Production, sales  
and administration  
are concentrated  
in Metzingen

## CONTENTS

140 years of experience	2-3
Applications/fields	4-5
Tailor-made solutions	6-7
Process analysis/ measurement engineering	8-9
Droplet separator system overview	10-11
Functional principle	12-13
Droplet separators for horizontal gas flow	14-16
Droplet separators for vertical gas flow	17-19
Housings	20-21
Installation-ready components	22
Cleaning nozzles	23
Industry examples	24-29
Lechler worldwide	30-31

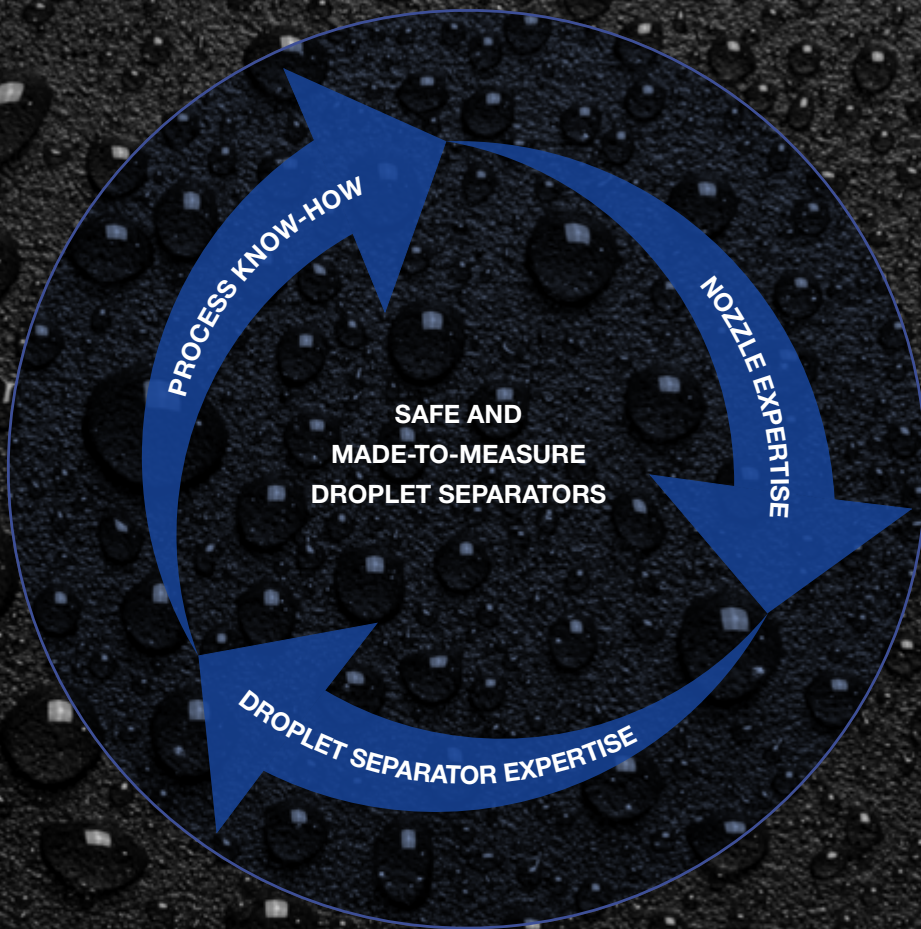

# 140

1879 - 2019

2010

Expansion of production  
with a new 13,000 m<sup>2</sup>  
Manufacturing Plant

2016

New Development  
and Technology Center  
is opened  
in Metzingen

2019

Celebrating  
140 years

2021

New factory  
in China

2022

New logistics center  
in Metzingen



# FROM APPLE JUICE TO CEMENT ON THE SAFE SIDE FOR EVERY APPLICATION



Whether white paper, tasty fruit juices or chemical products – quality and environmentally aware manufacturing processes are of key importance for every product. Efficient gas scrubbing is a crucial contribution to this in many areas.

In order to offer you the optimal solution for this, we dig deep into the related processes. Our great competitive advantage is based on a simple, but decisive factor: we consider gas and flow processes from both ends. As a nozzle specialist, we are extremely familiar with all the related questions – from production through to distribution of the droplets. As experts in the field of droplet separation, we know how we can use the characteristics of this distribution to achieve the most efficient separation of the droplets from the gas flow.

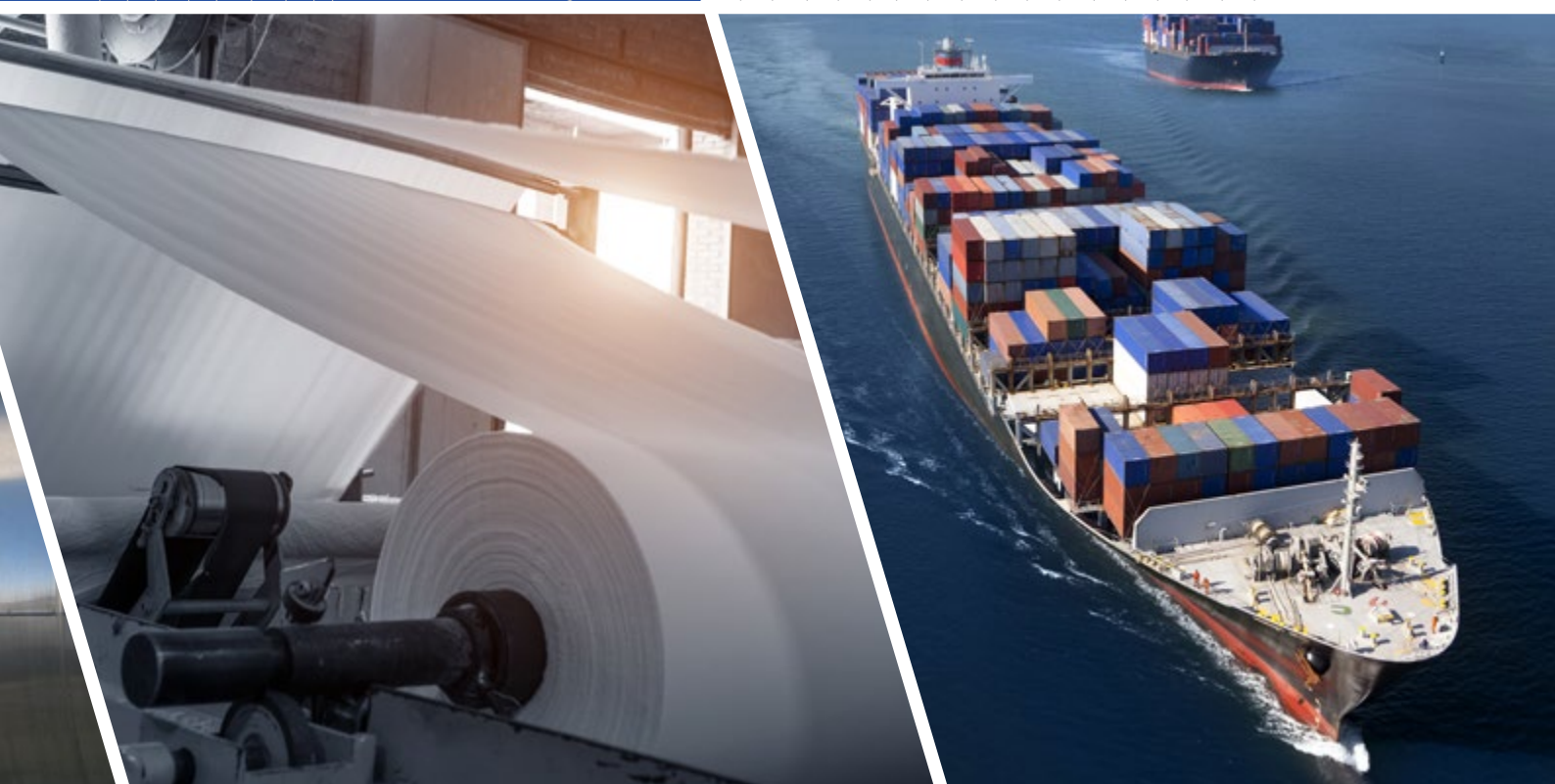

Over the course of many decades, we have realized a wide range of solutions in many different industries. Our experience extends from the process industry and energy generation as well as paper manufacturing, food and through to metallurgy.

On the process side, we are just as familiar with stripping, distillation, vaporization, evaporation and condensation as with desulfurization and denitration processes or steam generation and compression. No matter which process you may have, our experts have the tools and knowledge to provide you with the best possible solution. And that is exactly where we come in.

# EFFICIENCY IS A DRY SUBJECT

Anyone who wants to separate liquids from a gas flow has to understand droplets and their behavior. At Lechler, we have been working on exactly this for more than 140 years. As the global leading nozzle company for nozzle technology, we understand how droplets form, how they move and how they interact with each other and with surfaces.

We are not just interested in the individual droplets, but above all in the behavior of a droplet spectrum within specific processes. By calculating the influence of temperature, pressure, flow velocities and space conditions on the droplet distribution, we can develop a tailor-made separation solution for every process.

## A unique portfolio

In order to ensure maximum precision, all aspects of a droplet separator must be exactly defined. Is the material able to continuously withstand the temperatures? Is it also corrosion-resistant in aggressive environments? Is the chosen profile suitable for the flow velocity?

We find out the answers to these questions by means of detailed calculations and extensive tests in our laboratories. The result is one of the most comprehensive and flexible ranges of droplet separators. Different separator profiles are available for numerous applications which can be easily integrated into existing installations.



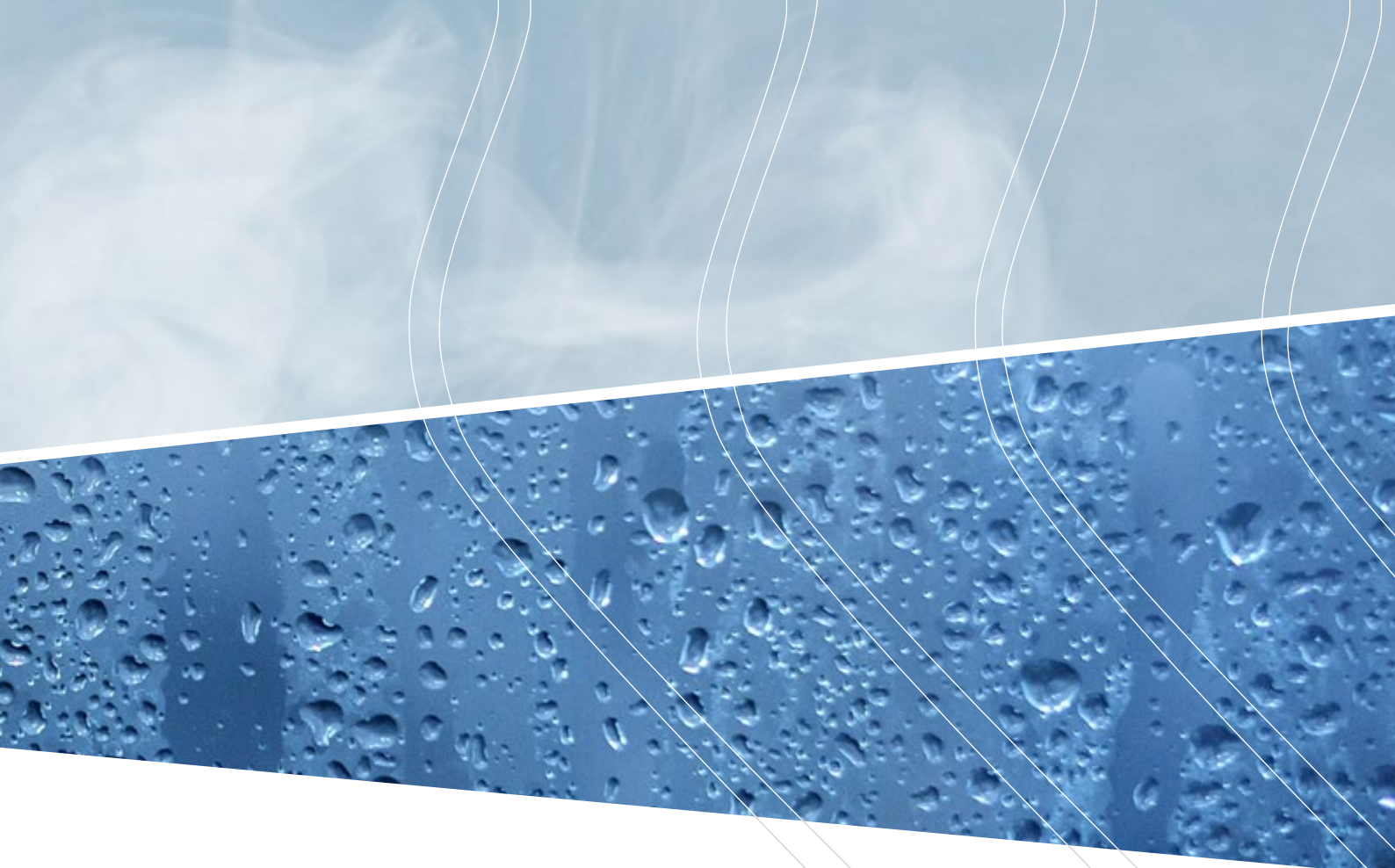

### As individual as your requirements

Do you need a tailor-made solution or do you want to optimize existing processes? Talk to us. Lechler offers maximum safety thanks to the outstanding quality of its droplet separators, combined with internationally successful nozzle expertise. Together with experienced, dedicated and practically-based process consulting for OEMs, engineering offices and end customers, Lechler is the expert for separation and air pollution control solutions.

## YOUR ADVANTAGES

- Outstanding process know-how
- First-class quality
- Materials matched to individual applications
- Wide, immediately available droplet separator range
- Tailor-made solutions



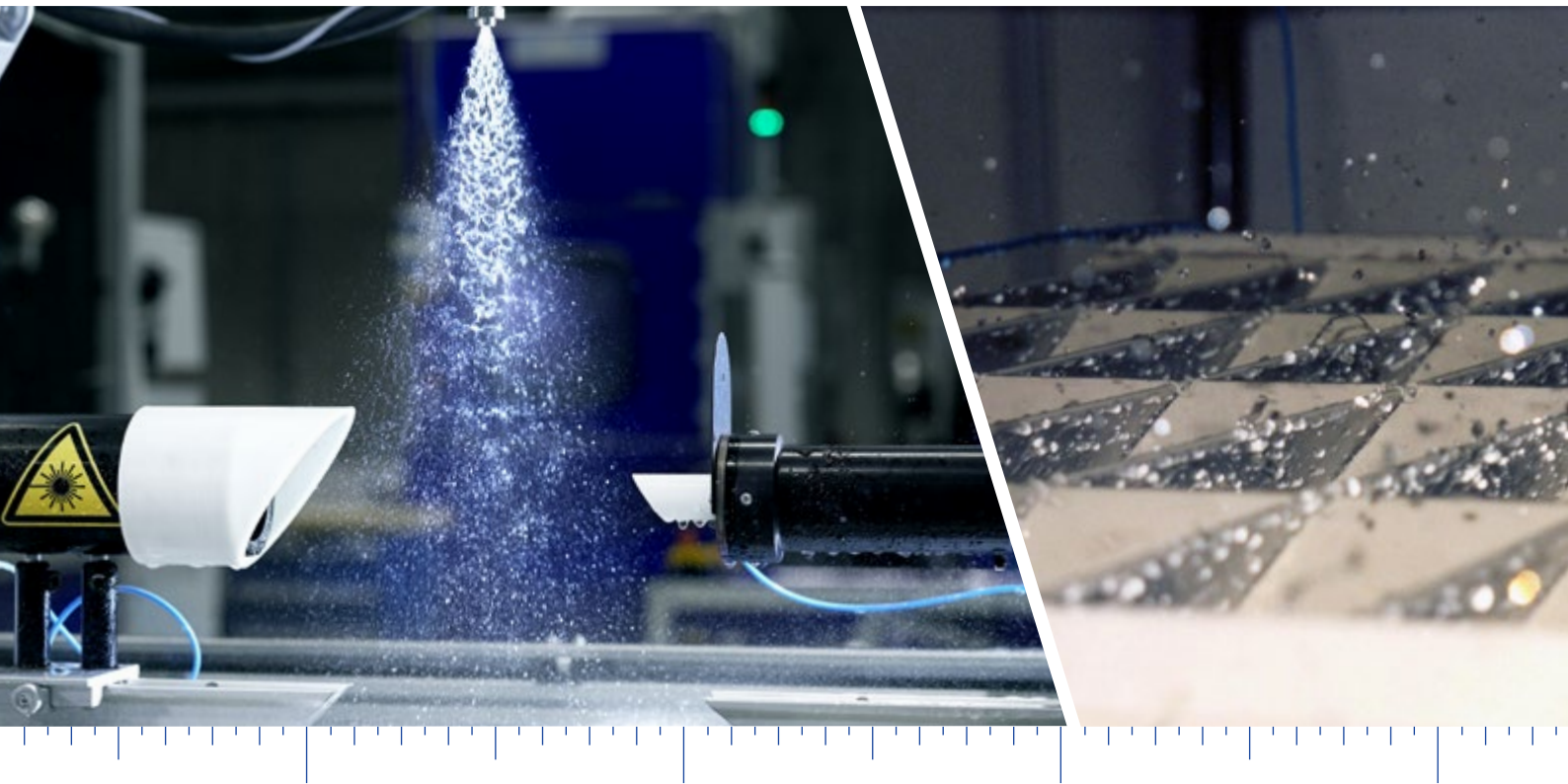

## IF YOU WANT FEWER DROPLETS YOU HAVE TO KNOW MORE ABOUT THEM

When it comes to droplet separation, we always need precise answers to the following questions: What droplet spectrum is present? How is this distributed and how does it move? In other words, we want to understand liquid-laden gas flows right down to the individual droplet and then make use of this knowledge.

### Welcome to the Lechler Technical Center

Our Development and Technology Center with an area of more than 600 m<sup>2</sup> accommodates everything that innovative nozzles developers dream of. High-performance test benches with different pump capacities allow us to investigate everything from microfine mist and large spray jets through to enormous flow rates.

This is where we put our products through their paces. Using state-of-the-art measuring equipment, we can measure the position, size, velocity and momentum of individual droplets in order to predict and influence the behavior of spray jets. We are therefore able to test separator applications under different operating conditions and optimize them for the correct application.

For our customers, these practically-based tests mean a unique time saving, while at the same time also reducing costs and giving them planning security.

### You can count on us when things get complex

We know all about flow behavior and turbulence in highly complex processes. Just like you know your own requirements inside out. Let us find out together how to make the most of your potential.

While the flow conditions in a straight duct can still be calculated with pencil and paper, this soon becomes impossible in ducts with multiple bends. That is where things become interesting and where the greatest optimization potential can be found.



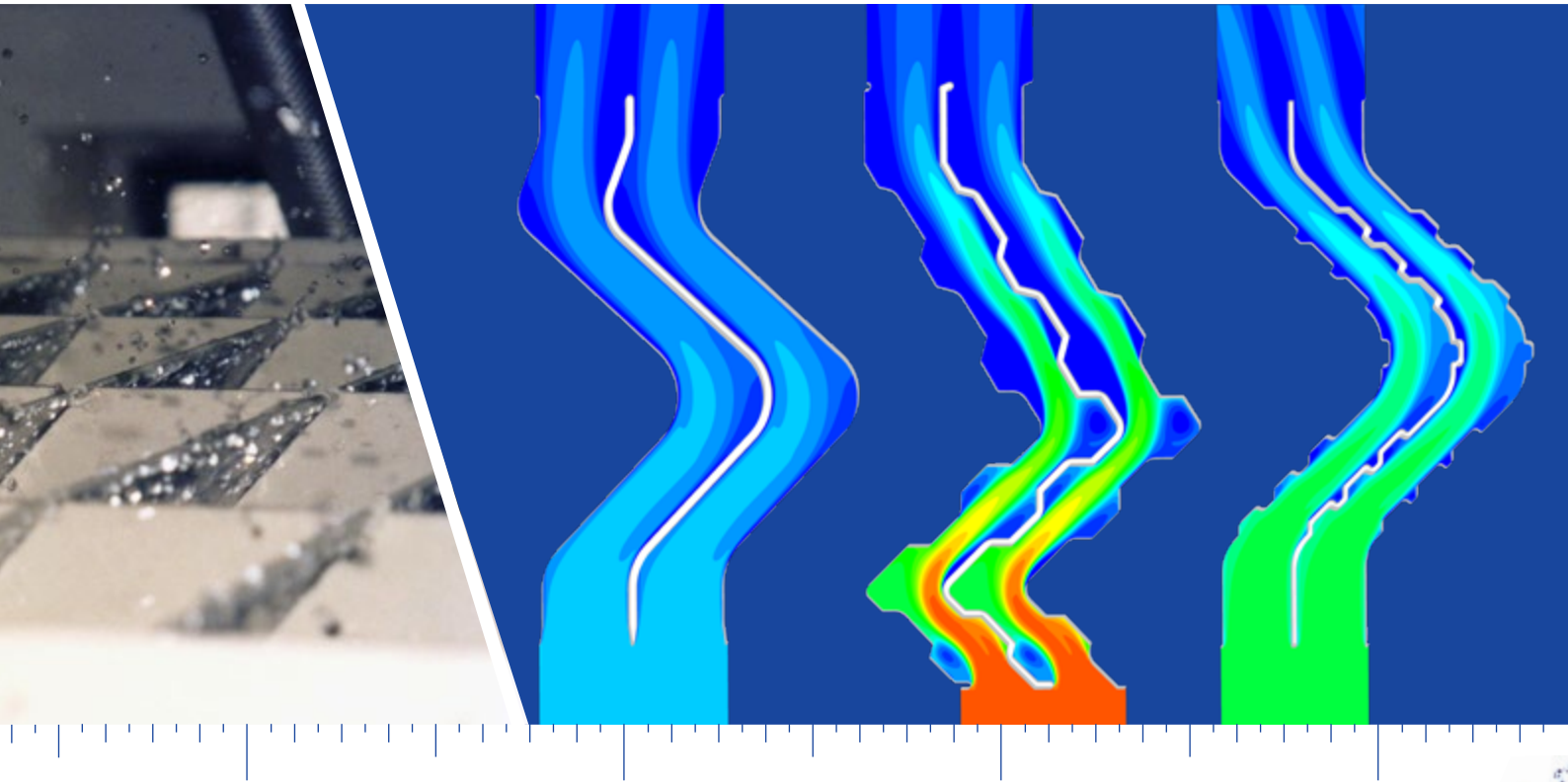

To find this potential, we use computational fluid dynamics, or CFD for short. Thanks to our own high-performance computer cluster, we can simulate different dimensioning scenarios and ambient conditions in order to obtain the optimum installation layout. This significantly speeds up planning and reduces costs. Our services also include detailed amortization calculations.

Make the most of our engineering experience. We will gladly support you in your process optimization with the know-how we have acquired over the course of many decades.

Talk to us now. We will gladly define the work package together with you and produce a specific offer based on your needs.

## YOUR ADVANTAGES

- Identification of optimization potentials
- Virtual evaluation of individual measures
- Risk-free, virtual tests
- Detailed process engineering design
- Demonstration of saving potentials

More information on the Development and Technology Center



[www.lechler.com/de-en/  
technology/services/  
measuringtechnology](http://www.lechler.com/de-en/technology/services/measuringtechnology)



# DROPLET SEPARATOR SYSTEMS OVERVIEW

## Droplet separators for maximum performance

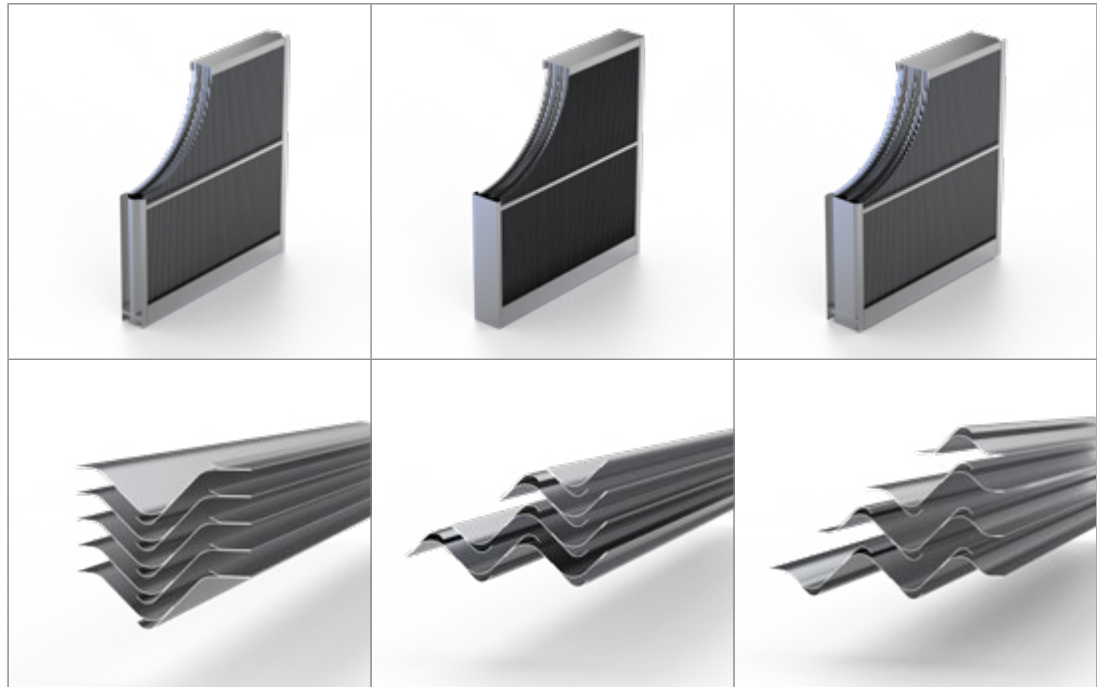

Series	LTH 100	LTH 500	LTH 600
Information on Page	14	15	16
Flow	Horizontal	Horizontal	Horizontal
Features	<ul style="list-style-type: none"> <li>• Multi-stage configuration possible</li> <li>• High separation performance</li> <li>• Low pressure loss</li> <li>• Variable baffle vane spacing to optimize pressure loss and limit droplets</li> <li>• Easy to clean</li> </ul>	<ul style="list-style-type: none"> <li>• Reduced installation depths</li> <li>• High separation performance</li> <li>• Available in four variants for optimum adaptation to process requirements</li> <li>• High hydraulic separation capacity</li> <li>• Variable profile spacing</li> <li>• Angled profile inlet and outlet design</li> </ul>	<ul style="list-style-type: none"> <li>• Highest separation performance</li> <li>• Low pressure loss</li> <li>• Available in four variants for optimum adaptation to process requirements</li> <li>• High hydraulic separation capacity</li> <li>• Variable profile spacing</li> <li>• Improved flow routing</li> <li>• Suitable for high flow velocities</li> </ul>
Materials	<ul style="list-style-type: none"> <li>• PPTV</li> <li>• PVDF</li> <li>• PE</li> <li>• Stainless steel</li> <li>• Special materials</li> </ul>	<ul style="list-style-type: none"> <li>• Stainless steel</li> <li>• Special materials</li> </ul>	<ul style="list-style-type: none"> <li>• PP</li> <li>• Stainless steel</li> <li>• Special materials</li> </ul>

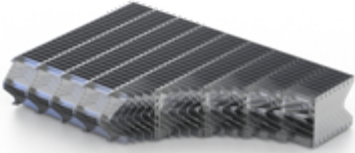
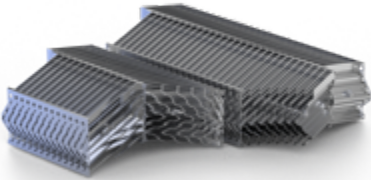
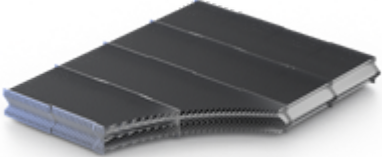
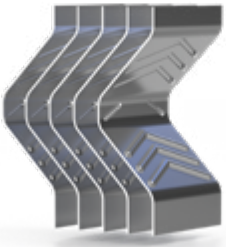
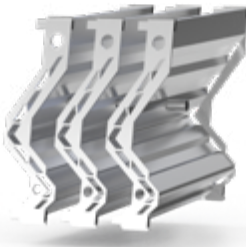
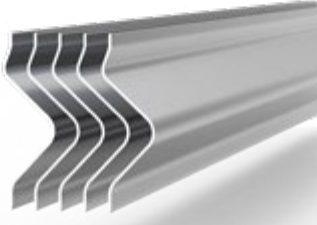
		
		
<b>LTV 271</b>	<b>LTV 300</b>	<b>LTV 400</b>
17	18	19
Vertical	Vertical	Vertical
<ul style="list-style-type: none"> <li>• Standardized profile widths</li> <li>• Good separation performance</li> <li>• Low pressure loss</li> <li>• 23 mm baffle vane spacing</li> </ul>	<ul style="list-style-type: none"> <li>• Highest hydraulic separation capacity</li> <li>• Highest separation performance</li> <li>• Installation at angles up to 45°</li> </ul>	<ul style="list-style-type: none"> <li>• Very good separation performance with minimum pressure loss</li> <li>• Suitable for high dust loads</li> <li>• Variable widths and baffle vane spacing</li> <li>• Reduced support structure</li> <li>• Easy to clean</li> </ul>
<ul style="list-style-type: none"> <li>• PP</li> <li>• PVDF</li> <li>• PE</li> </ul>	<ul style="list-style-type: none"> <li>• PP</li> <li>• PVDF</li> <li>• PE</li> <li>• Stainless steel</li> <li>• Special materials</li> </ul>	<ul style="list-style-type: none"> <li>• PPTV</li> <li>• PVDF</li> <li>• PE</li> <li>• Stainless steel</li> <li>• Special materials</li> </ul>



# FUNCTIONAL PRINCIPLE

## HOW TO DRY A GAS FLOW

Lechler droplet separators are vane-type separators that work based on the principle of inertia. For separation, a flow of gas laden with liquid droplets is routed through a grill made of curved and specially formed baffle vanes. While the gas flow is deflected at the vanes, the carried droplets maintain their flight path due to the forces of inertia and strike the profile wall.

Whether a droplet reaches the profile wall depends on several factors:

- Baffle vane geometry and spacing
- Gas and liquid parameters
- Composition of the droplet spectrum

The smallest droplets that under the given conditions still come fully into contact with the profile wall and form a liquid film there are referred to as limit droplets.



## Primary separation

In the primary separation stage, all droplets with a diameter larger than the limit droplet diameter are theoretically separated with a rate of 100%. A lower proportion of droplets with a diameter smaller than the limit droplet diameter is separated here. This share can be calculated as a fractional degree of separation and determines the separation performance.

## Secondary separation

The shape of the separation vanes determines how quickly and completely the liquid film formed in the primary separation stage is drained from the profile wall. The separation vanes are equipped with specially formed phase separation chambers for this purpose. Their form and size determine the pressure loss of the separation system together with the number of directional changes in the gas flow.

## Horizontal, vertical or oblique gas flow

Lechler high-performance droplet separators are available for horizontal and vertical flows. Separators are also realized for oblique gas flow in some special cases. The choice of flow direction depends on the individual process or plant design.



Horizontal flow

### Droplet separators with horizontal gas flow

Here the separation vanes are arranged vertically to the gas flow so that the liquid runs down the vanes due to gravity. Flow-calmed zones before, in or after the phase separation chambers ensure that the liquid film can flow off there without renewed contact with the gas flow. Since flow-off is assisted by gravity, particularly high separation performance can be achieved here. Depending on design, gas flow rates of up to 12 m/s are possible under normal conditions. The flow-optimized shape of the baffle vanes minimizes pressure losses.

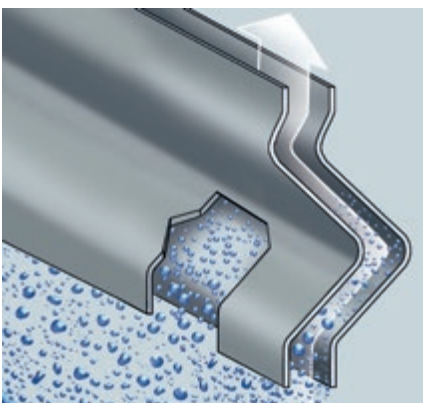

Vertical flow

### Droplet separators with vertical gas flow

In vane-type separators with vertical gas flow, the baffle vanes are arranged horizontally or at a slight angle to the horizontal. The liquid must run off downwards in the opposite direction to the gas flow, which means that it is subject to interaction with the gas flowing towards it. Flow-calmed zones on the baffle vanes collect the liquid from the primary separation stage so that it does not have any interaction with the gas flow above it. The liquid is also reliably drained off the vane surface in these zones. For this, the droplets of the draining liquid film must be significantly larger than the droplets suspended in the flowing gas. Otherwise smaller droplets will be picked up again and will place an unnecessary load on the system. Lechler therefore offers droplet separators for vertical gas flows with different liquid run-off designs.

# ➤➤ LTH 100

## Horizontal flow

### Features

- Multi-stage configuration possible
- High separation performance
- Low pressure loss
- Variable baffle vane spacing to optimize pressure loss and limit droplets
- Easy to clean

### Materials

- PPTV
- PVDF
- PE
- Stainless steel
- Special materials

The LTH 100 is characterized by its flexible application and combination possibilities. The sinusoidally corrugated profile geometry with protruding phase separation chambers achieves high separation performance over a large velocity range. The LTH 100 is a universal droplet separator system that has proven itself over many decades.

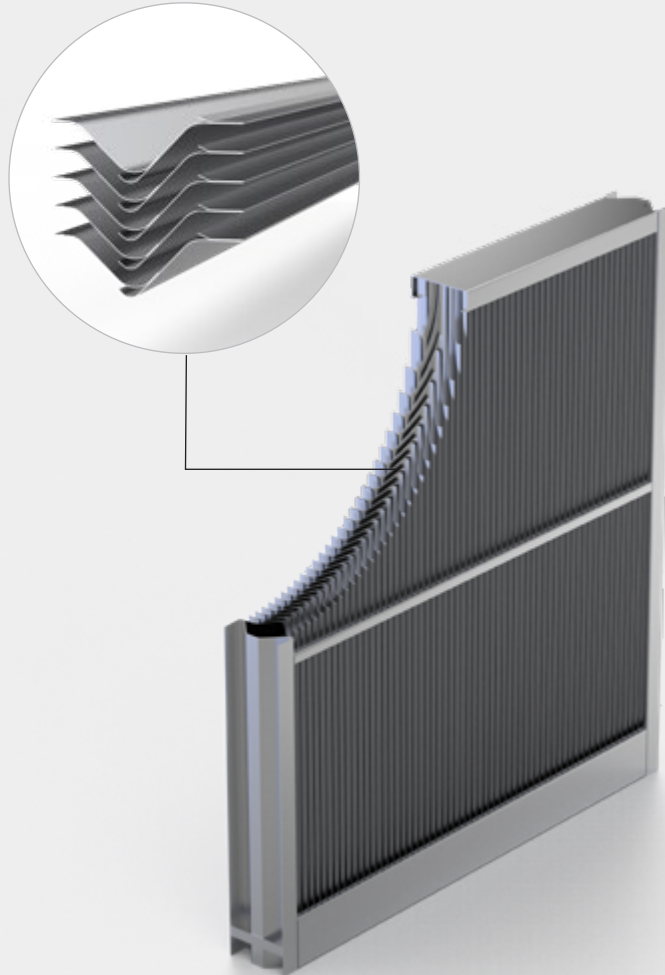

**LTH 100 pressure loss diagram**

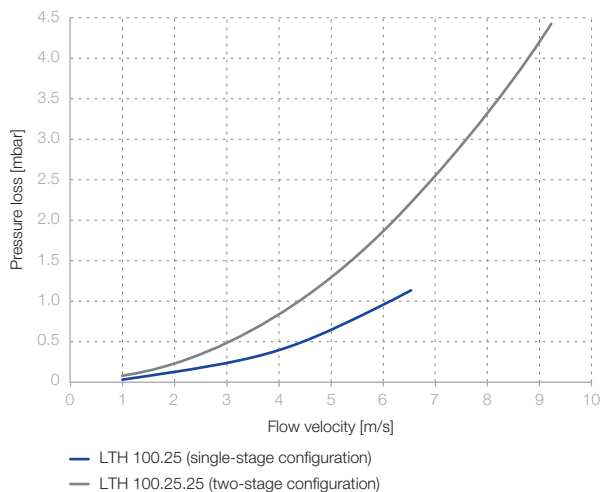

**LTH 100 limit droplet diagram**

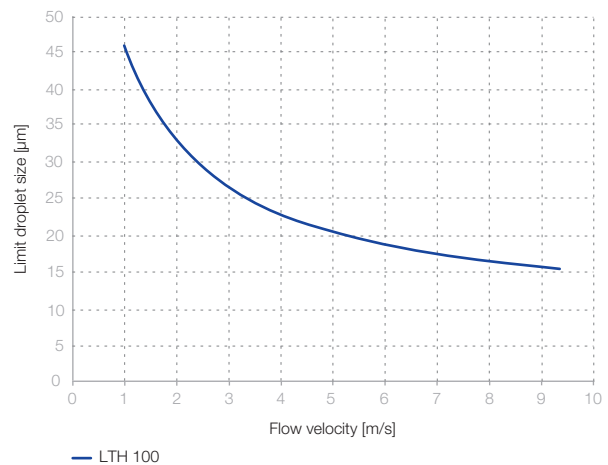

The technical values apply to the system water/air under standard conditions and with a baffle vane spacing of 25 mm.

# ➤➤ LTH 500

## Horizontal flow

### Features

- Reduced installation depths
- High separation performance
- Available in four variants for optimum adaptation to process requirements
- High hydraulic separation capacity
- Variable profile spacing
- Angled profile inlet and outlet design

### Materials

- Stainless steel
- Special materials

The LTH 500 series impresses with a low overall depth and is particularly suitable for cramped installation conditions. This series is characterized by the angled inlet and outlet design of the profile geometry.

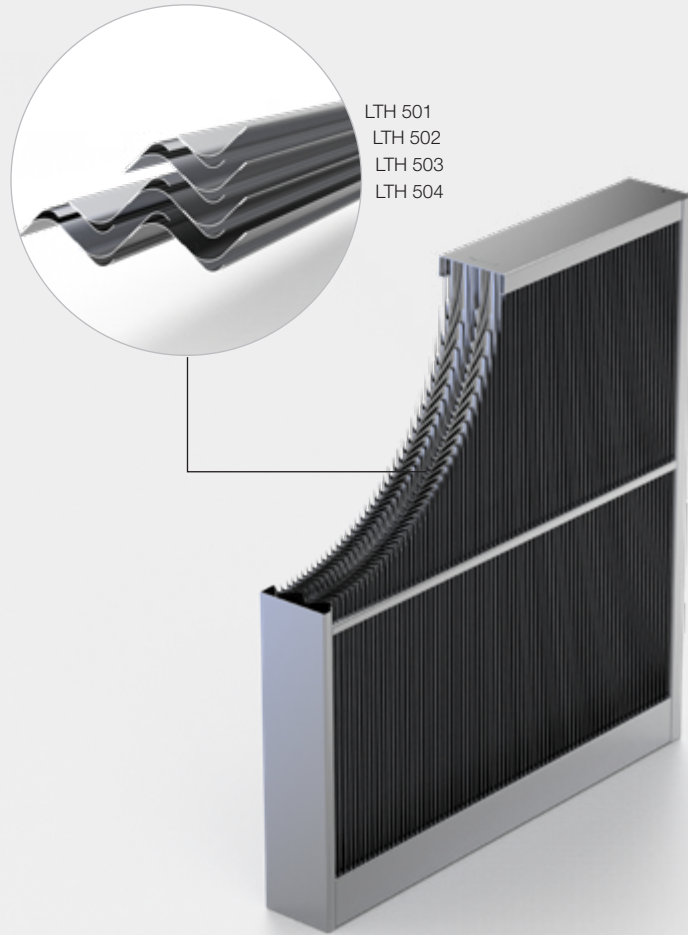

**LTH 500 pressure loss diagram**

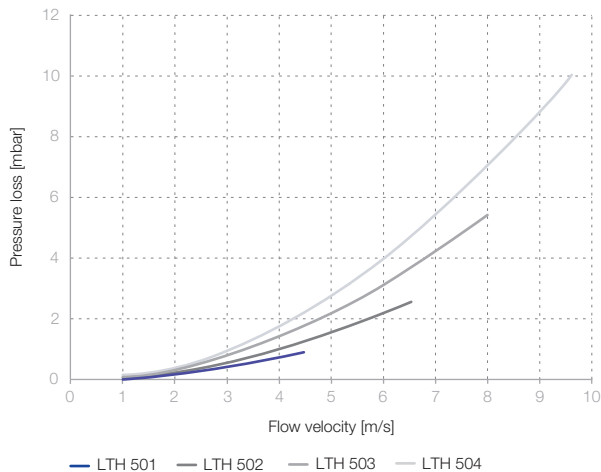

**LTH 500 limit droplet diagram**

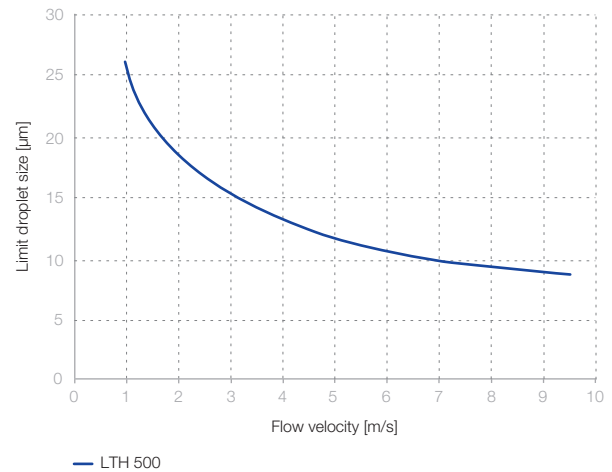

The technical values apply to the system water/air under standard conditions and with a baffle vane spacing of 25 mm.

# ➤➤ LTH 600

## Horizontal flow

### Features

- Highest separation performance
- Low pressure loss
- Available in four variants for optimum adaptation to process requirements
- High hydraulic separation capacity
- Variable profile spacing
- Improved flow routing
- Suitable for high flow velocities

### Materials

- PP
- Stainless steel
- Special materials

The LTH 600 series is the highest-performance horizontal-flow droplet separator in our range. Developed to meet the highest demands, the LTH 600 is characterized by the straight inlet and outlet design of the profile geometry, which results in improved flow routing and highest separation performance at high flow velocities.

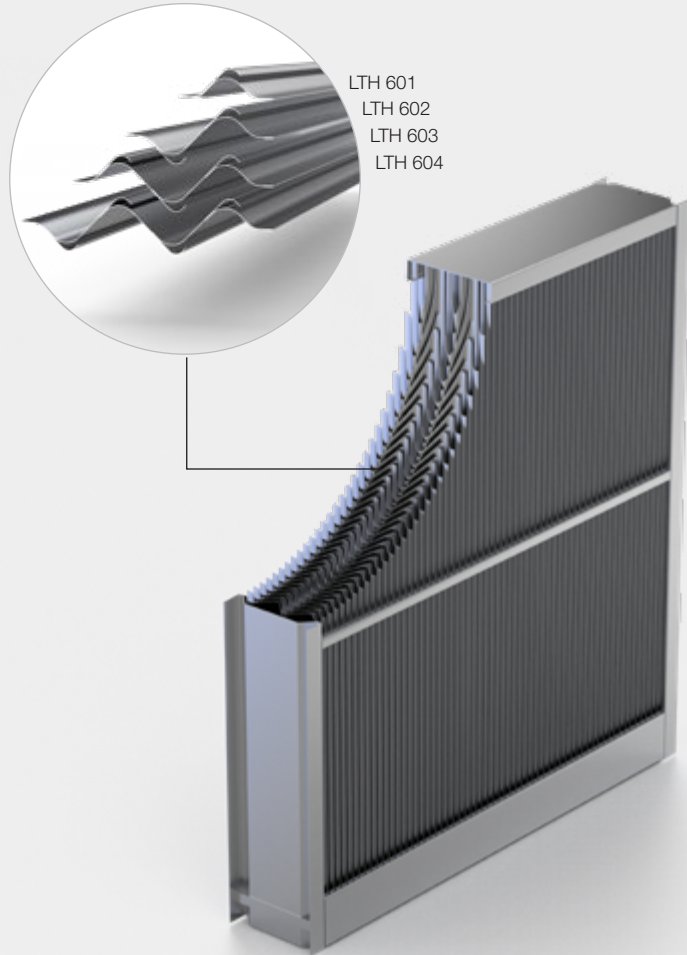

**LTH 600 pressure loss diagram**

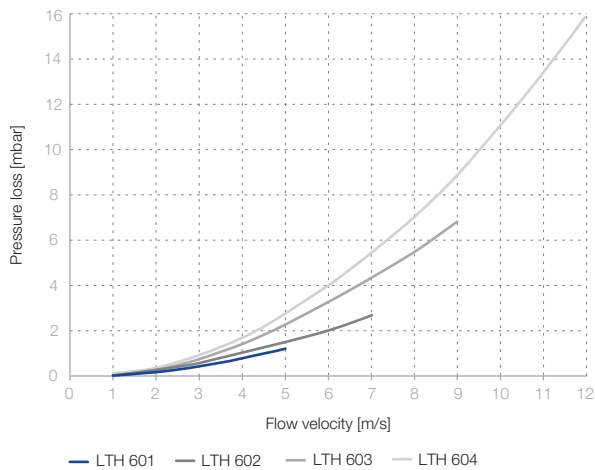

**LTH 600 limit droplet diagram**

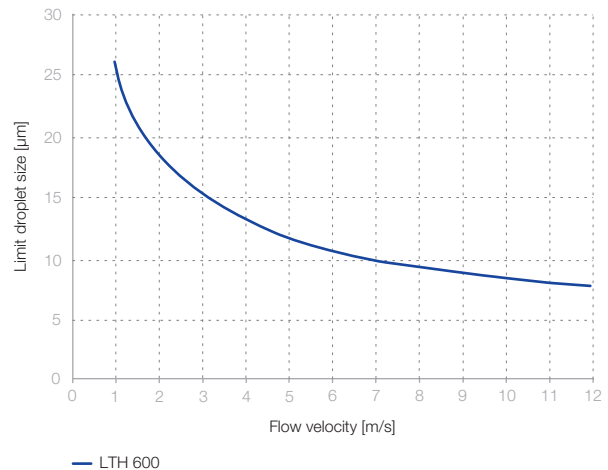

The technical values apply to the system water/air under standard conditions and with a baffle vane spacing of 25 mm.



# **LTV 271** Vertical flow

## Features

- Standardized profile widths
- Good separation performance
- Low pressure loss
- 23 mm baffle vane spacing

## Materials

- PP
- PVDF
- PE

The LTV 271 is a droplet separator system that has proven itself over many decades. It is available in standard widths of 305, 610 and 905 mm. The grooves in the profile geometry guarantee good run-off behavior of the separated liquid with low pressure losses.

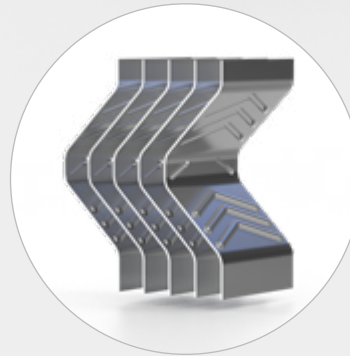
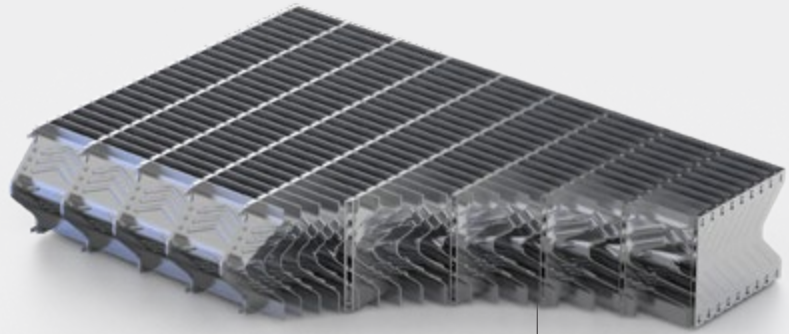

**LTV 271 pressure loss diagram**

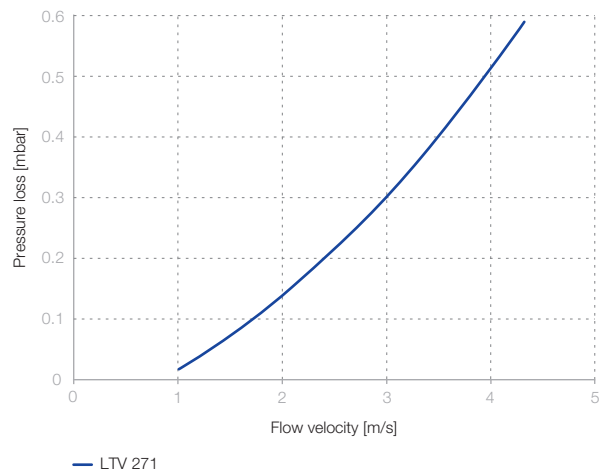

**LTV 271 limit droplet diagram**

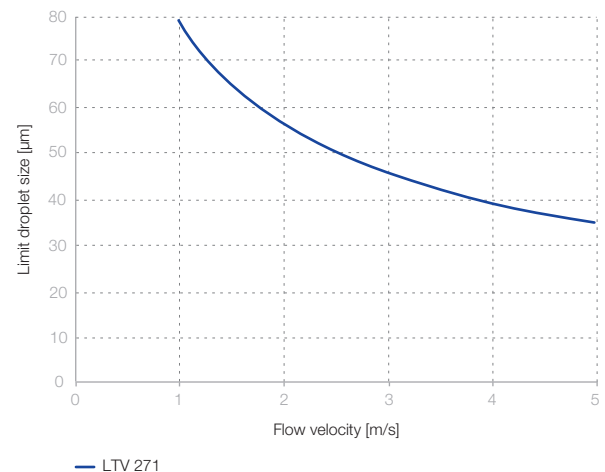

The technical values apply to the system water/air under standard conditions and with a baffle vane spacing of 23 mm.

# ➤➤ LTV 300

## Vertical flow

### Features

- Highest hydraulic separation capacity
- Highest separation performance
- Installation at angles up to 45°

### Materials

- PP
- PVDF
- PE
- Stainless steel
- Special materials

The LTV 300 with its complex profile geometry was developed for the highest separation performance in vertical gas flows. Installation of this separator profile at an angle of up to 45° guarantees improved run-off of the separated liquid and dust particles and makes it possible to cope with high liquid quantities.

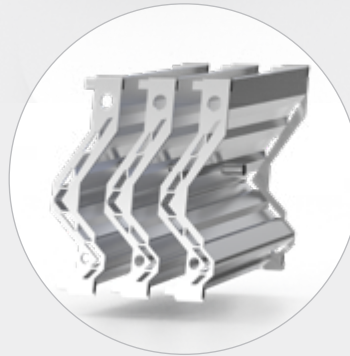
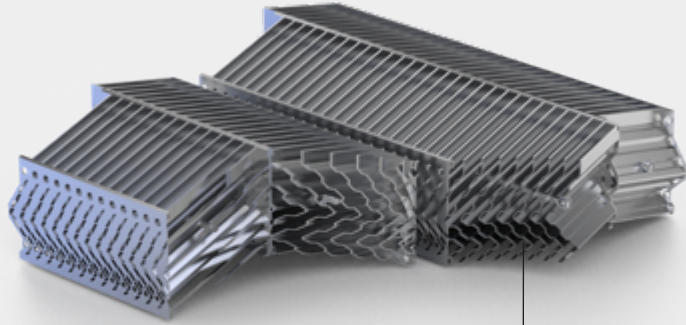

**LTV 300 pressure loss diagram**

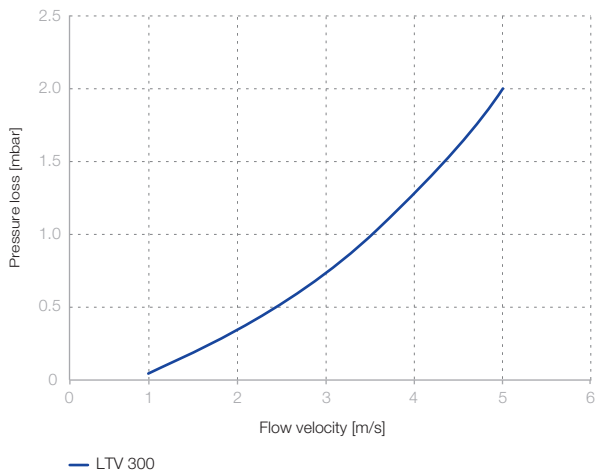

**LTV 300 limit droplet diagram**

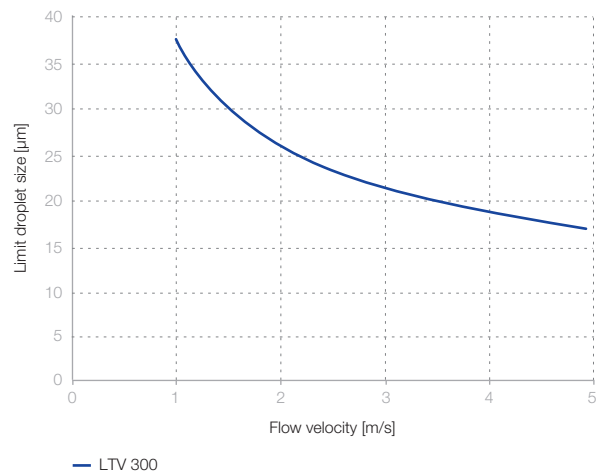

The technical values apply to the system water/air under standard conditions and with a baffle vane spacing of 30 mm.

# **LTV 400** Vertical flow

## Features

- Very good separation performance with minimum pressure loss
- Suitable for high dust loads
- Variable widths and baffle vane spacing
- Reduced support structure
- Easy to clean

## Materials

- PPTV
- PVDF
- PE
- Stainless steel
- Special materials

Thanks to its large number of design options, the LTV 400 can be easily adapted to the individual operating requirements. The smooth profile surface without grooves is particularly important here. This is easy to clean and has a low fouling tendency even with high dust loads. The variable installation length of the droplet separators makes it possible to achieve a high savings potential in the design of the support structure.

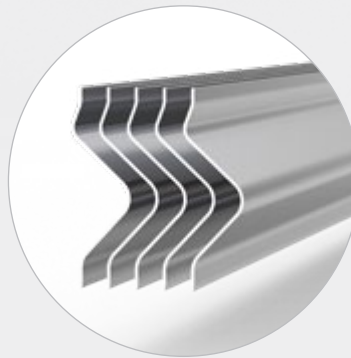
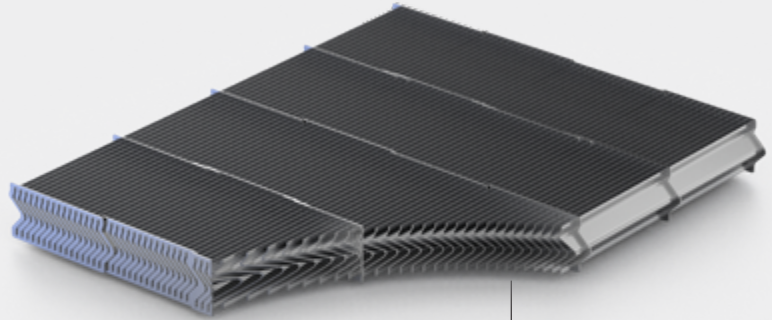

**LTV 400 pressure loss diagram**

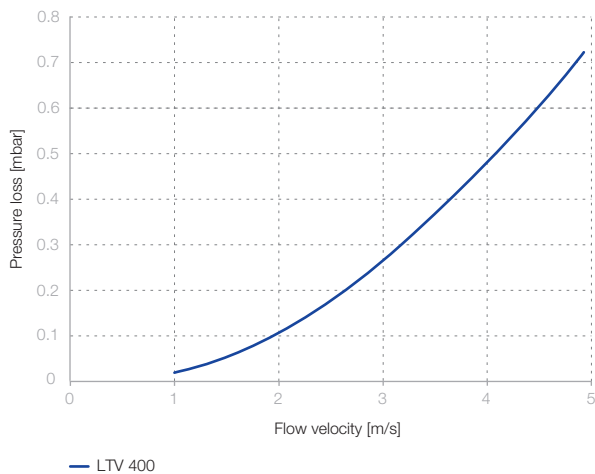

**LTV 400 limit droplet diagram**

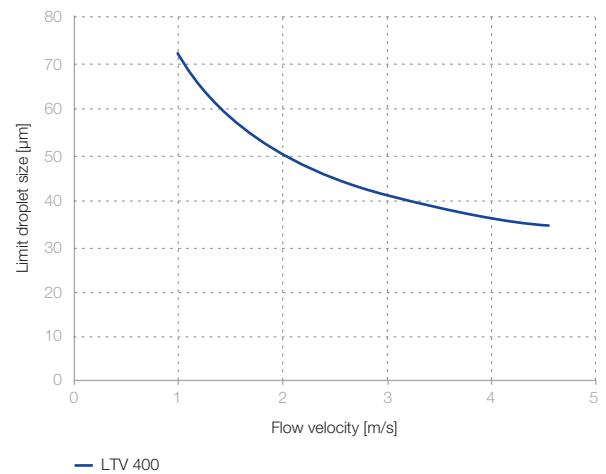

The technical values apply to the system water/air under standard conditions and with a baffle vane spacing of 25 mm.

# ➤ A GOOD ENVIRONMENT WITH BEST REFERENCES INSTALLATION-READY COMPONENTS

In order to achieve optimum separation performance, droplet separators must also be mechanically integrated into the respective environment in the best possible way. We provide the components needed for this according to your specifications.



We manufacture tanks and housings according to individual customer specifications

## Tanks and housings

The housing design is important for the proper functioning of the separator. In order to avoid malfunctions due to incorrect flow routing, we specify the most important dimensions for every droplet separator. However, if you want to be on the safe side right from the start, we will gladly provide you with a complete solution that is tailored to your specific needs.

The requirements for flow routing naturally also apply to tanks. As for housings, we provide you with the most important dimensions for your own tanks or produce a safe and convenient complete package for you. The corresponding design code (AD2000, ASME, Selo etc.) is naturally stipulated by you and applied corresponding to your specification.

## Support construction

More complex support structures are often needed when droplet separators are installed in tanks. For this reason, we specify the most important dimensions here also. Supports are possible for one or more separator frames.

## Other separator components

Depending on application, additional separator components such as inlets, half-pipes or baffle plates may be needed. We will gladly advise you here on design and realization.

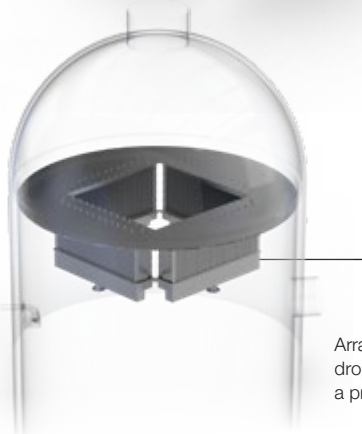
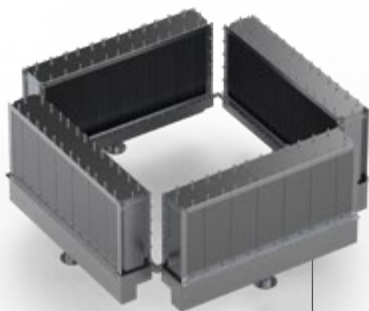

Arrangement of four droplet separators in a pressure tank

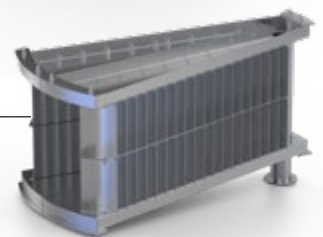
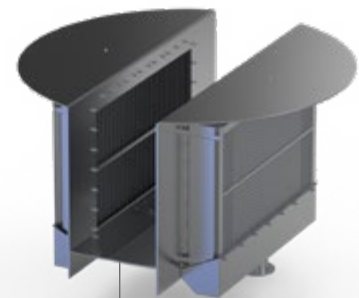
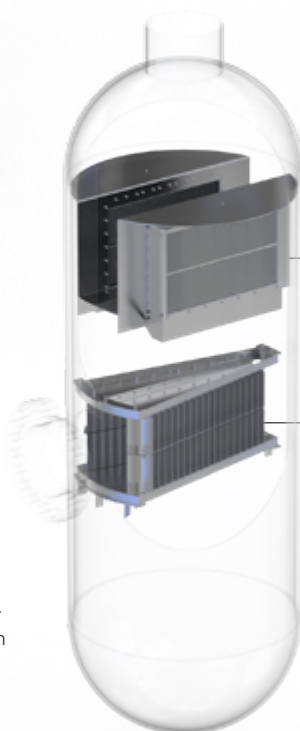

Pressure tank with an inlet device for separation of surge liquids



# LECHLER CLEANING NOZZLES FOR CLEAN RESULTS IN THE LONG TERM

Gas flows with a high dust load can lead to deposits and caking even in flow-optimized designs, and this can impair the efficiency of the droplet separators. In order to guarantee availability in continuous operation even under difficult conditions, it is recommended to install a cleaning system.

Cyclical spraying of the droplet separators with full cone nozzles has proven itself particularly suitable here – ideally with nozzles mounted to the front and rear of the droplet separators. With comparatively little effort, it is therefore possible to increase operating reliability, avoid encrustations and guarantee optimum efficiency in the long term.

We will gladly support you in configuring a suitable cleaning system. Suitable nozzles for every application are also always available from our comprehensive range of full cone nozzles.

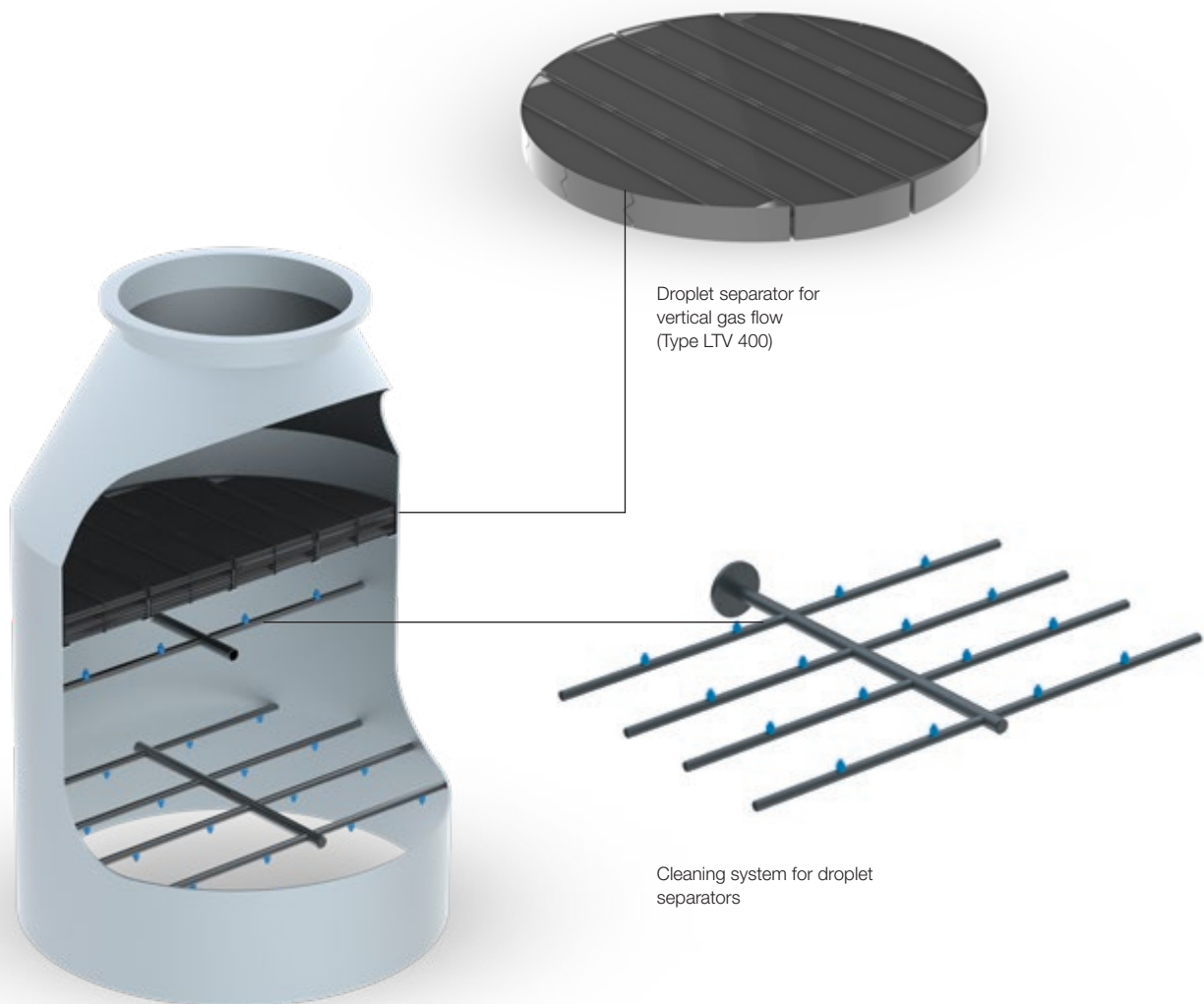



# DROPLET SEPARATION IN PRACTICE SHIPBUILDING



In shipbuilding, droplet separators play an important part in ensuring compliance with environmental laws and also protect downstream ship systems. They are used both in air intake systems as protection against rain and splash water and also in treatment of the exhaust gases from the engines. They also play an important part in contributing to decarbonization in the shipping industry.

## Desulfurization by wet scrubbing

Due to the increasingly strict limits for sulfur levels and the expansion of the Emission Control Areas, retrofitting efficient scrubbers has now also become an important prerequisite for economical operation of older ships.

## Droplet separators for charge air coolers

In tropical climates, the intake air for the ship engines generates up to 200 tonnes of condensed water per day. Lechler droplet separators are also able to separate such large quantities and thus protect the combustion chambers from damage due to water ingress.



Droplet separator systems for air intakes are available in many sizes and reliably protect system components against corrosion and damage.

## Task

- Use in wet scrubbers for cleaning exhaust gases
- Protection of downstream installations

## Advantages

- Modular system design
- Highest degrees of separation for large liquid quantities
- Separation of small droplets
- Compact design even for high gas velocities
- Low pressure losses
- More uniform flow distribution
- Use also with high solid particle quantities
- Cleaning during ongoing operation

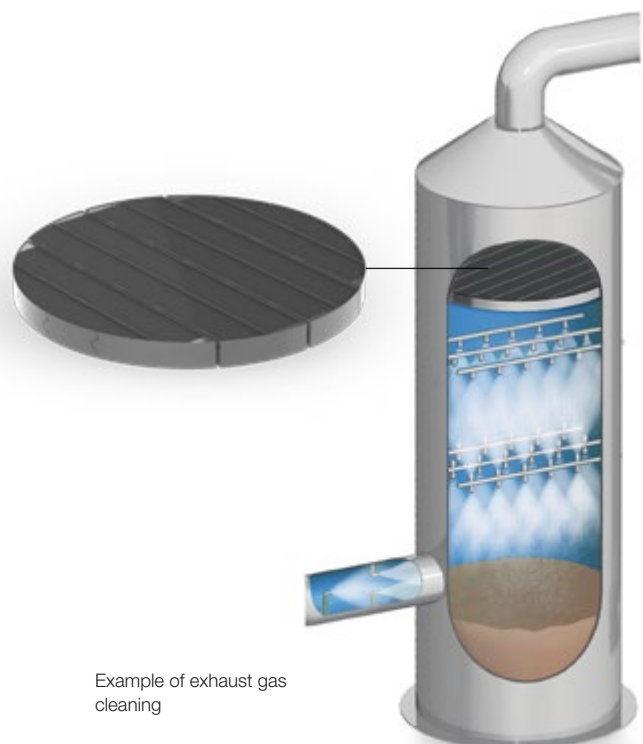

Example of exhaust gas cleaning

# »» DROPLET SEPARATION IN PRACTICE CHEMICAL INDUSTRY



Droplet separators play an essential role in process engineering and chemical plants. They protect system components, save energy, increase product output and are a decisive factor when it comes to sustainably reducing undesirable emissions.

For this, droplet separators must be able to separate even the finest droplets with a diameter of less than 5 micrometers while at the same time minimizing pressure losses. This is possible only with effective separation systems that function in the long term even in highly corrosive environments and that can be seamlessly integrated into the existing installation. This in turn needs the right materials, an in-depth understanding of the respective operating processes and naturally also the suitable droplet separators. We offer all of this from a single source.

## Task

- Gas absorption
- Condensation
- Demineralization
- Distillation
- Evaporation

## Advantages

- Modular system design
- Highest degrees of separation for large liquid quantities
- Separation of small droplets
- Compact design even for high gas velocities
- Low pressure losses
- High corrosion resistance
- Use also with high solid particle quantities

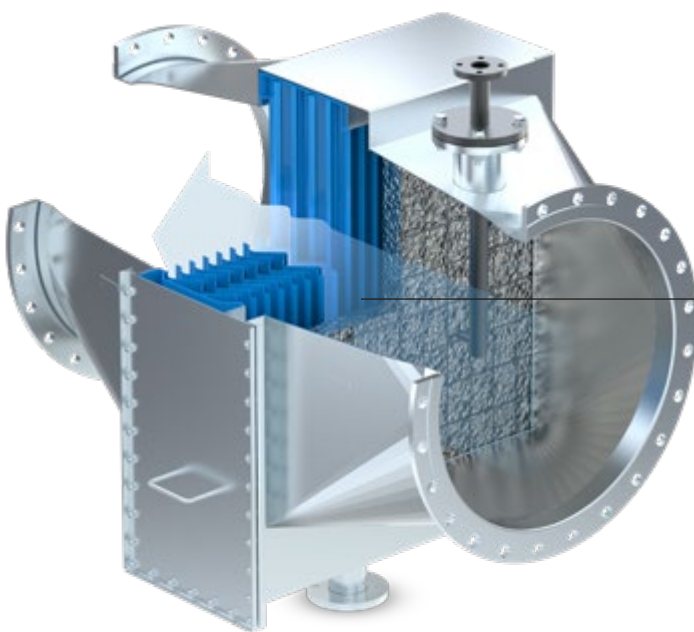

Housing with droplet separator for horizontal gas flow (Type LTH 600) and agglomerator

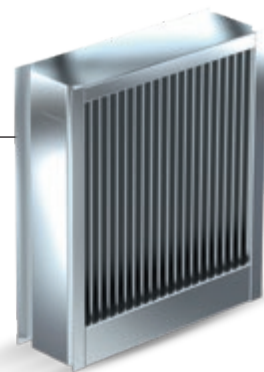

Droplet separator for horizontal gas flow (Type LTH 600)



# DROPLET SEPARATION IN PRACTICE PAPER INDUSTRY



Energy efficiency is an important competitive factor in the paper industry. In particular, optimized processing and re-use of chemicals can achieve significant cost reductions. Efficient droplet separators play a crucial part in chemical recovery of the raw materials used. Optimized separation elements make it possible to achieve excellent separation performance even under conditions with high steam loads. We will gladly advise you.

## Task

- Black lye evaporation
- Recovery of chemicals
- Scrubbers

## Advantages

- Highest degrees of separation for large liquid quantities
- Separation of small droplets
- Compact design even for high gas velocities
- Low pressure losses



"Cake Piece" separator  
in an evaporator

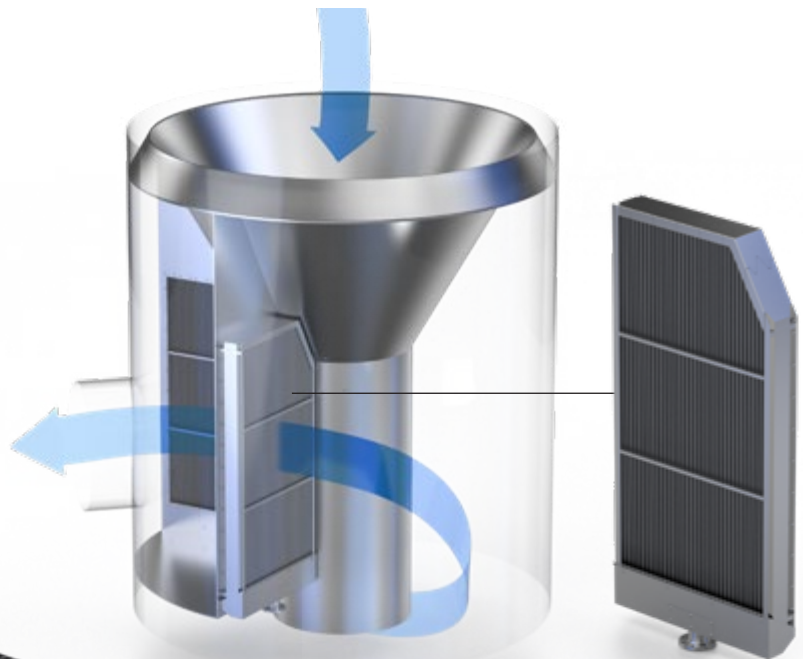

Horizontal flow separator  
in an evaporator





# DROPLET SEPARATION IN PRACTICE FOOD AND BEVERAGE INDUSTRY



Evaporation and separation processes can be found everywhere in the food and beverage industry. It is not just about achieving a high product yield here, but also always about ensuring compliance with strict hygiene requirements. High-performance droplet separators can significantly increase efficiency in numerous processes – assuming that they have been specifically designed and constructed for the respective installation. Talk to us!

## Task

- Evaporation in juice and sugar production
- Distillation processes
- Drinking water production

## Advantages

- Highest degrees of separation for large liquid quantities
- Separation of small droplets
- Compact design even for high gas velocities
- Low pressure losses

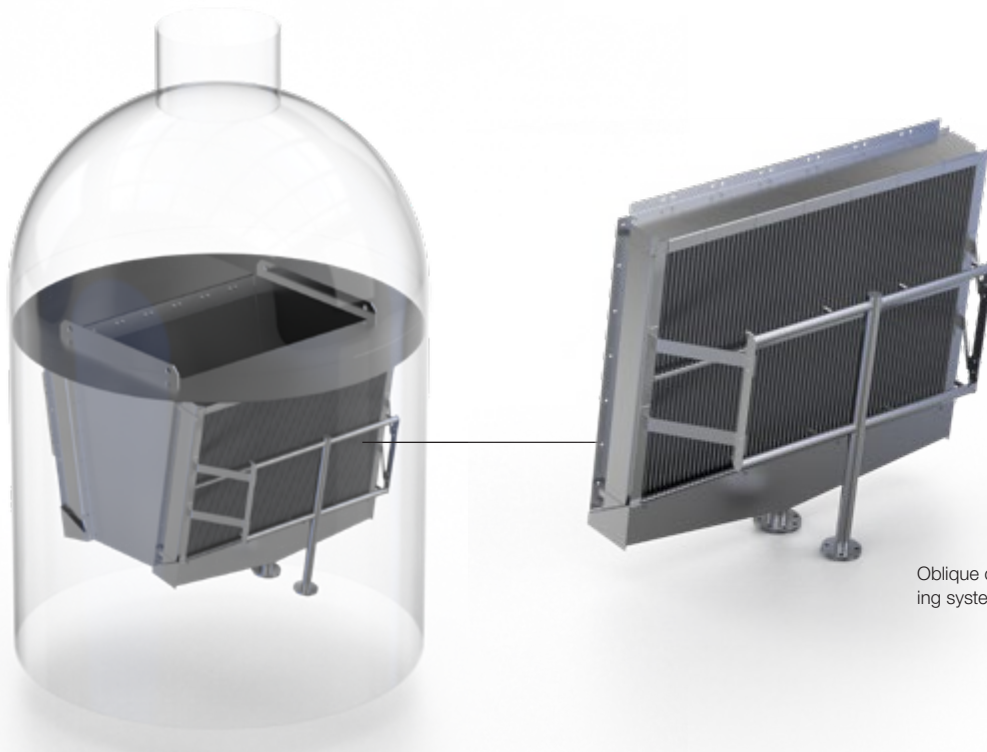

Oblique droplet separator with cleaning system for horizontal gas flow



# DROPLET SEPARATION IN PRACTICE METALLURGY



In the entire iron and steel manufacturing industry as well as in aluminum and non-ferrous metallurgy, the flue gases can be cleaned by wet scrubbers. These huge quantities of mist suspensions are produced as a result and can be separated – just like in other places in the process chain.

For a long time now, nozzles and droplet separators from Lechler have contributed to reduce emissions along the process chain and protect plant components. We are extremely familiar with the processes in the metal industry and can offer you tailor-made solutions.

## Task

- Corrosion avoidance
- Solid matter separation
- Liquid separation
- Emission reduction
- Gas cleaning

## Advantages

- Highest degrees of separation for large liquid quantities
- Separation of small droplets
- Compact design even for high gas velocities
- Low pressure losses
- Tailor-made solutions

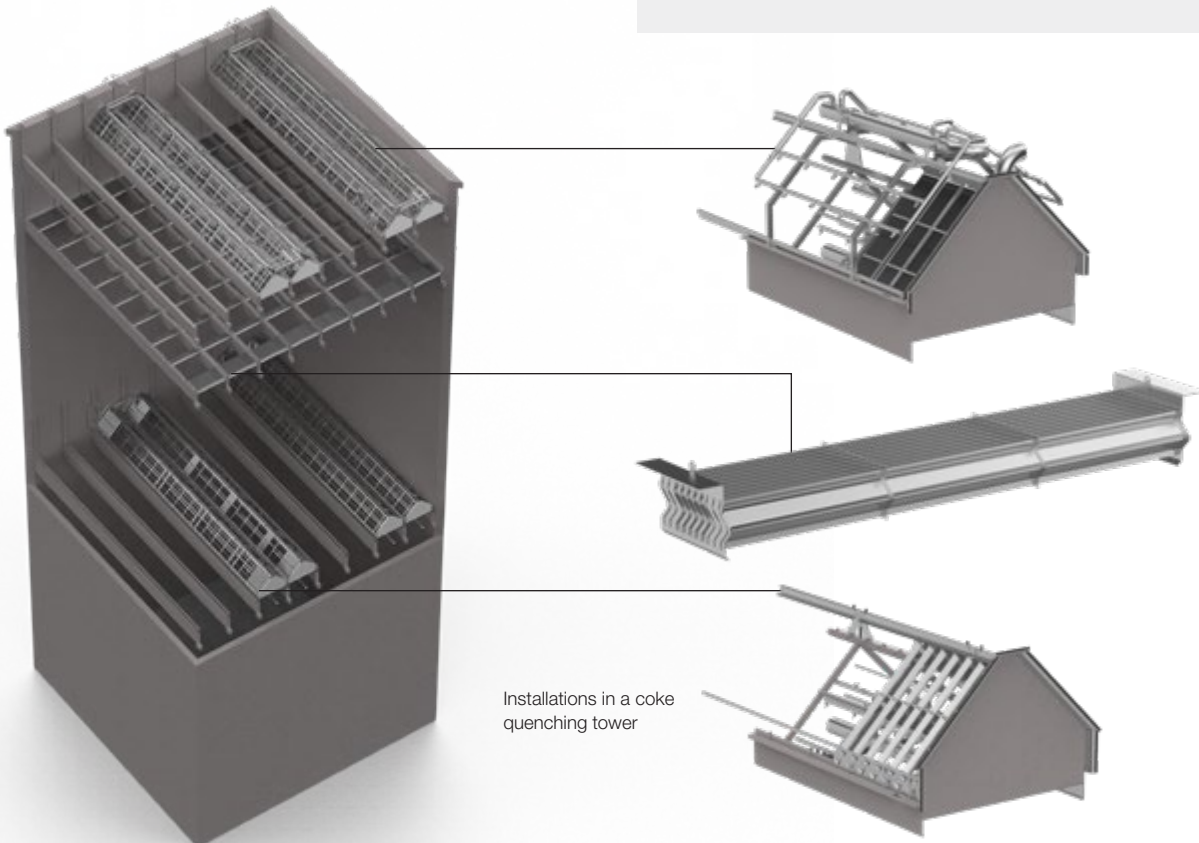

Installations in a coke quenching tower

# ➤➤ DROPLET SEPARATION IN PRACTICE FLUE GAS DESULFURIZATION



Thanks to the introduction of wet flue gas desulfurization, it has been possible to sustainably reduce emissions over the course of recent decades and meet even stringent environmental requirements. We are proud of our contribution to this achievement. Because it is here above all that it is possible to see the advantages of considering droplets from their production through to separation.

The highest separation results can be achieved only through combination of highly wear-resistant and corrosion-resistant nozzles made of silicon carbide with tailor-made droplet separators. We therefore offer a coordinated overall concept with efficient nozzles for flue-gas scrubbing as well as the matching droplet separators with integrated cleaning system. We supply droplet separator systems in different materials and designs to meet your requirements.

## Task

- Removal of sulfur compounds
- Protection of downstream installation components
- Reduction of operating costs
- Increase in plant uptime

## Advantages

- Highest degrees of separation for large liquid quantities
- Separation of extremely small droplets
- Compact design even for high gas velocities
- Low pressure losses
- More uniform flow distribution
- Use also with high solid particle quantities
- Cleaning during ongoing operation
- Low residual liquid quantities

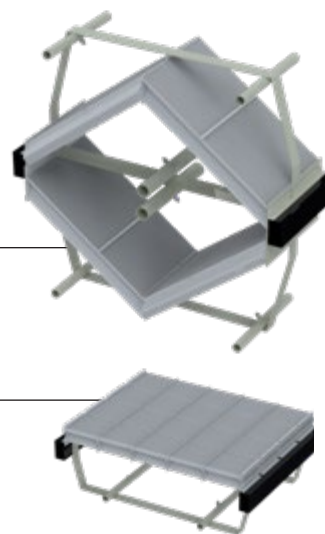
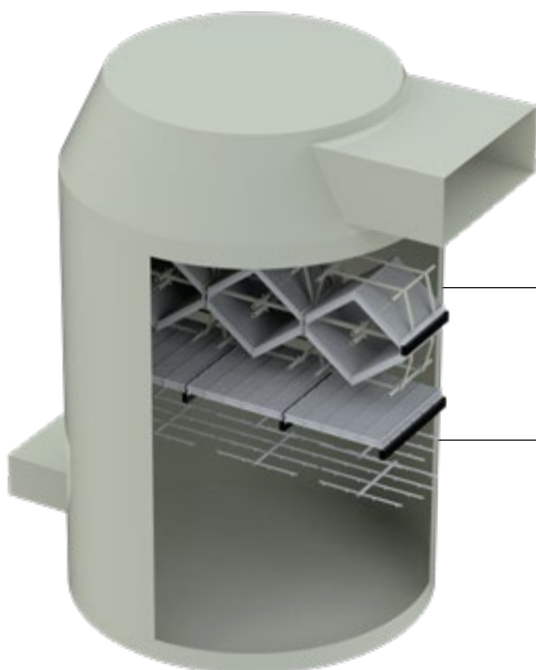

LTV 120 C  
Two-stage droplet separator systems with integrated cleaning system are particularly suitable for cramped installation conditions

LTV 400



# EVERYTHING COVERED DROPLETS UNDER CONTROL WORLDWIDE





-  **Headquarters**
-  **Production**
-  **Sales**

**Germany**  
 Lechler GmbH  
 Ulmer Strasse 128  
 72555 Metzingen  
 Phone +49 7123 962-0  
 info@lechler.de

**China**  
 Lechler Nozzle Systems  
 (Changzhou) Co., Ltd.  
 No.99 Decheng Rd, Jintan  
 Changzhou, JS 213200, P.R.C  
 Phone +86 519-6822 8088  
 info@lechler.com.cn

**India**  
 Lechler (India) Pvt. Ltd.  
 Plot B-2  
 Main Road  
 Wagle Industrial Estate Thane  
 400604 Maharashtra  
 Phone +91 22 40634444  
 lechler@lechlerindia.com

**USA**  
 Lechler Inc.  
 445 Kautz Road  
 St. Charles, IL 60174  
 Phone +1 630 3776611  
 info@lechlerusa.com

**ASEAN**  
 Lechler Spray Technology  
 Sdn. Bhd.  
 No. 22, Jalan Astaka 4B/KU2  
 Bandar Bukit Raja  
 41050 Klang, Selangor  
 Malaysia  
 Phone +603 3359 1118  
 info@lechler.com.my

**Belgium**  
 Lechler S.A./N.V.  
 Avenue Newton 4  
 1300 Wavre  
 Phone +32 10 225022  
 info@lechler.be

**Finland**  
 Lechler Oy  
 Ansatie 6 a C 3 krs  
 01740 Vantaa  
 Phone +358 207 856880  
 info@lechler.fi

**France**  
 Lechler France SAS  
 Bât. CAP2  
 66-72 Rue Marceau  
 93100 Montreuil  
 Phone +33 1 49882600  
 info@lechler.fr

**Great Britain**  
 Lechler Ltd.  
 1 Fell Street, Newhall  
 Sheffield, S9 2TP  
 Phone +44 114 2492020  
 info@lechler.com

**Italy**  
 Lechler Spray Technology S.r.l.  
 Via Don Dossetti, 2  
 20080 Carpiano (MI)  
 Phone +39 2 98859027  
 info@lechleritalia.com

**Spain**  
 Lechler, S.A.  
 C / Isla de Hierro, 7 –  
 Oficina 1.3  
 28703 San Sebastián de  
 los Reyes (Madrid)  
 Phone +34 91 6586346  
 info@lechler.es

**Sweden**  
 Lechler AB  
 Kungsängsvägen 31B  
 753 23 Uppsala  
 Phone +46 18 167030  
 info@lechler.se

**Full range from one source**

Efficient droplet separation is crucial in many processes. Controlled generation and distribution of the droplets are just as important.

With over 140 years of nozzle expertise and over 45,000 immediately available nozzles, spray systems and accessories, we can provide every spray jet application in a short time. The combination of a wide range of proven full cone nozzles for scrubber applications and gas conditioning and tailor-made droplet separators makes it possible to achieve efficiency advantages that no other competitor can offer.

**Global representation**

We are at home right at the heart of Europe. In Aachen, Germany, we have developed unique expertise in planning, calculation and realization of high-performance droplet separator solutions. We support you here with our highly qualified experts and sales partners all over the world.

We do not just see ourselves as a supplier, we are also here to support you in process optimization on-site. Thanks to our international network of production locations, subsidiaries and sales offices/sales representatives, we can always guarantee fast part availability and short distances for service work. Contact us and experience this for yourself.

**We look forward to hearing from you.**

**ENGINEERING**  
**YOUR SPRAY SOLUTION**



**Lechler GmbH · Droplet separator systems**

**Charlottenburger Allee 7 · 52088 Aachen, Germany · Phone +49 241 463751-40 · dropletseparator@lechler.de**

**Headquarter: Lechler GmbH · Precision Nozzles · Nozzle systems**

**Ulmer Strasse 128 · 72555 Metzingen, Germany · Phone +49 7123 962-0 · info@lechler.de · www.lechler.com**

**ASEAN:** Lechler Spray Technology Sdn. Bhd. · 22, Jln. Astaka 4B/KU2 · Bdr. Bukit Raja · 41050 Klang · Malaysia · Phone +603 3359 1118 · info@lechler.com.my

**Belgium:** Lechler S.A./N.V. · Avenue Newton 4 · 1300 Wavre · Phone +32 10 225022 · info@lechler.be

**China:** Lechler Nozzle Systems (Changzhou) Co., Ltd. · No.99 Decheng Rd, Jintan, Changzhou, JS 213200, P.R.C · Phone +86 519-6822 8088 · info@lechler.com.cn

**Finland:** Lechler Oy · Ansatie 6 a C 3 krs · 01740 Vantaa · Phone +358 207 856880 · info@lechler.fi

**France:** Lechler France SAS · Bât. CAP2 · 66-72 Rue Marceau · 93100 Montreuil · Phone +33 1 49882600 · info@lechler.fr

**Great Britain:** Lechler Ltd. · 1 Fell Street, Newhall · Sheffield, S9 2TP · Phone +44 114 2492020 · info@lechler.com

**India:** Lechler (India) Pvt. Ltd. · Plot B-2 · Main Road · Wagle Industrial Estate Thane · 400604 Maharashtra · Phone +91 22 40634444 · lechler@lechlerindia.com

**Italy:** Lechler Spray Technology S.r.l. · Via Don Dossetti, 2 · 20080 Carpiano (Mi) · Phone +39 2 98859027 · info@lechleritalia.com

**Spain:** Lechler, S.A. · C / Isla de Hierro, 7 – Oficina 1.3 · 28703 San Sebastián de los Reyes (Madrid) · Phone +34 91 6586346 · info@lechler.es

**Sweden:** Lechler AB · Kungsängsvägen 31B · 753 23 Uppsala · Phone +46 18 167030 · info@lechler.se

**USA:** Lechler Inc. · 445 Kautz Road · St. Charles, IL 60174 · Phone +1 630 3776611 · info@lechlerusa.com