

# Sistemas fachada de vidrio

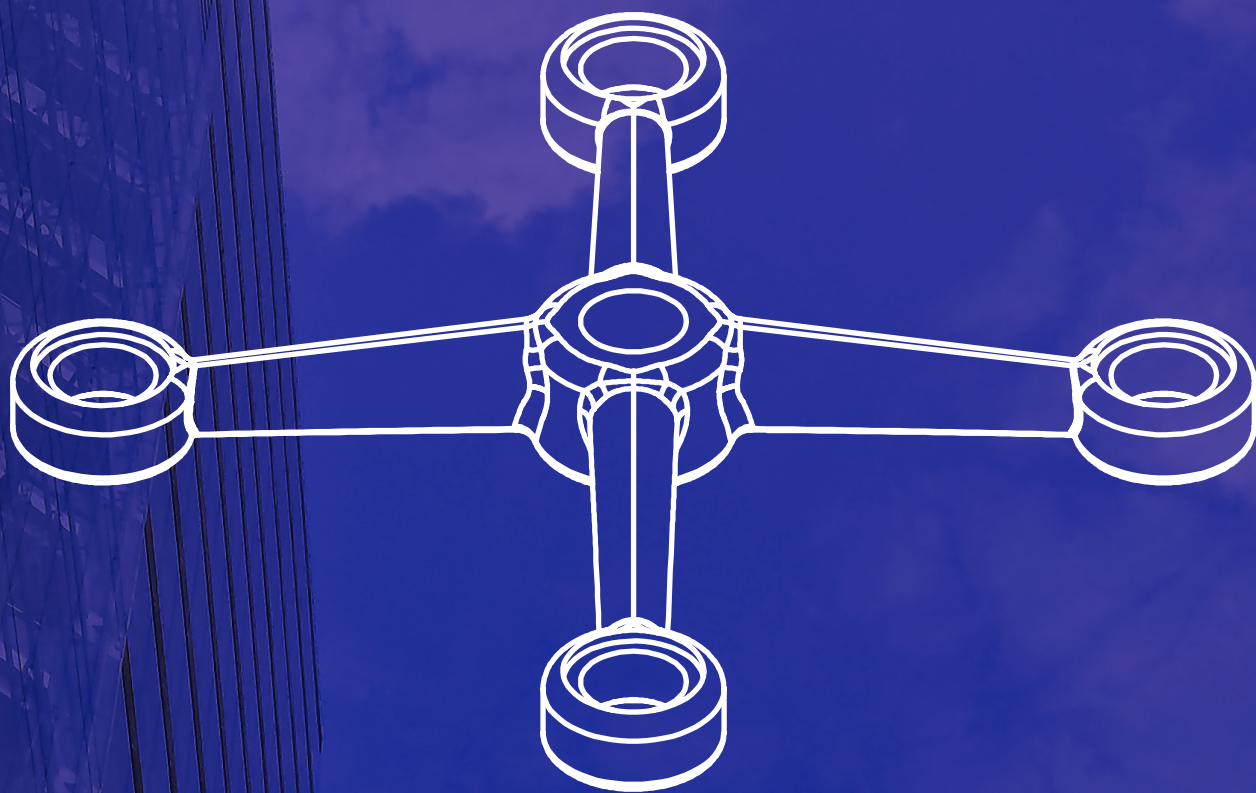

13.1 - ARAÑAS Y RÓTULAS FITECHNIC.....572-582

13.2 - MURO-CORTINA SILICONGLOSS.....583



# 13.1 - ARAÑAS Y RÓTULAS FITECHNIC



## ESTRUCTURAL ABOTONADO

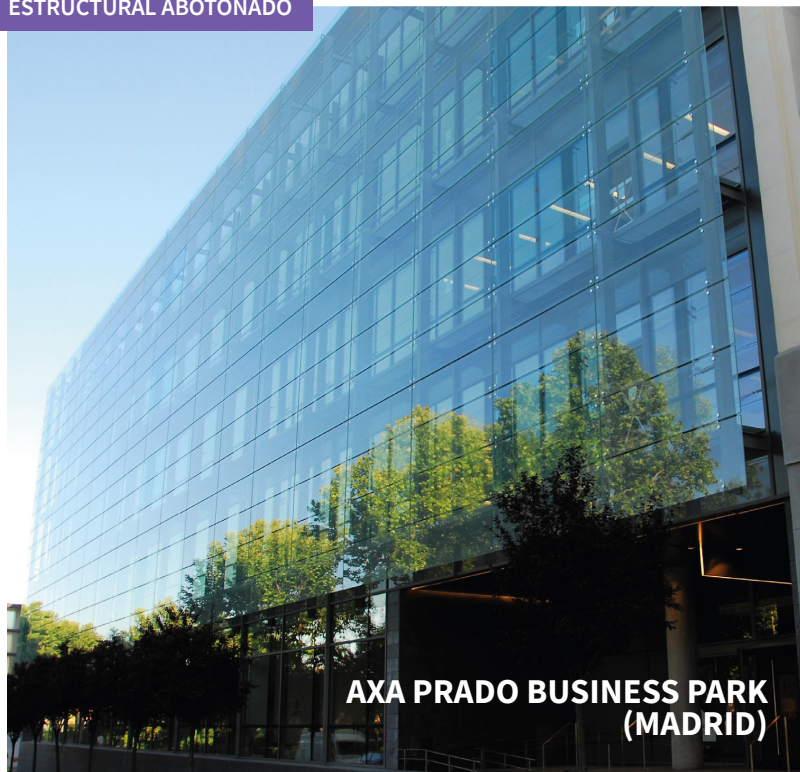

AXA PRADO BUSINESS PARK (MADRID)

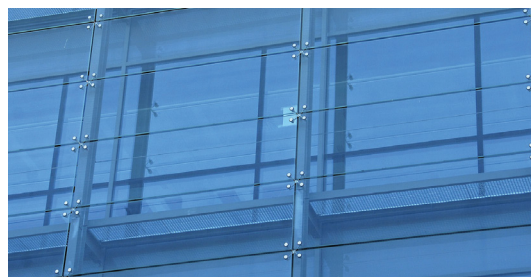

ABRANTE "LA GOMERA" (ISLAS CANARIAS)

AISI-316

### CERTIFICACIONES DE CALIDAD

- Estudio/Desarrollo productos por ensayos de elementos finitos
- Ensayos laboratorios independientes
- Certificaciones de calidad Acero Inoxidable AISI-316
- Certificaciones según ensayos de carga SGS

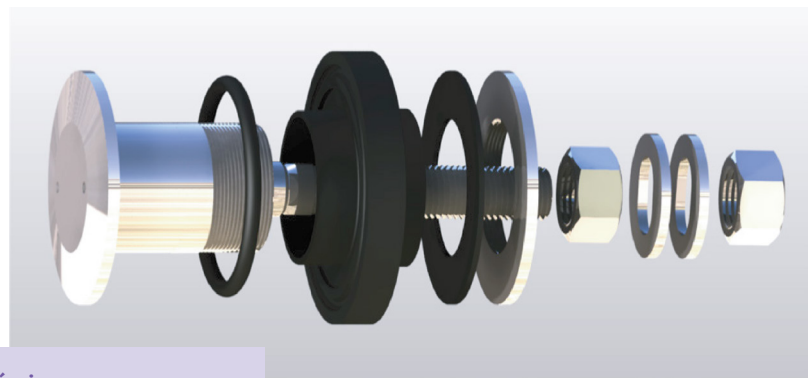
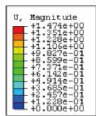
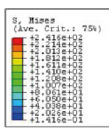

#### Características técnicas:

- Sistema V.E.A. (vidrio estructural abotonado)
- Paneles de vidrios sujetos puntualmente por medio de arañas
- Ingeniería de fachada estructural optimizando la transparencia de la fachada

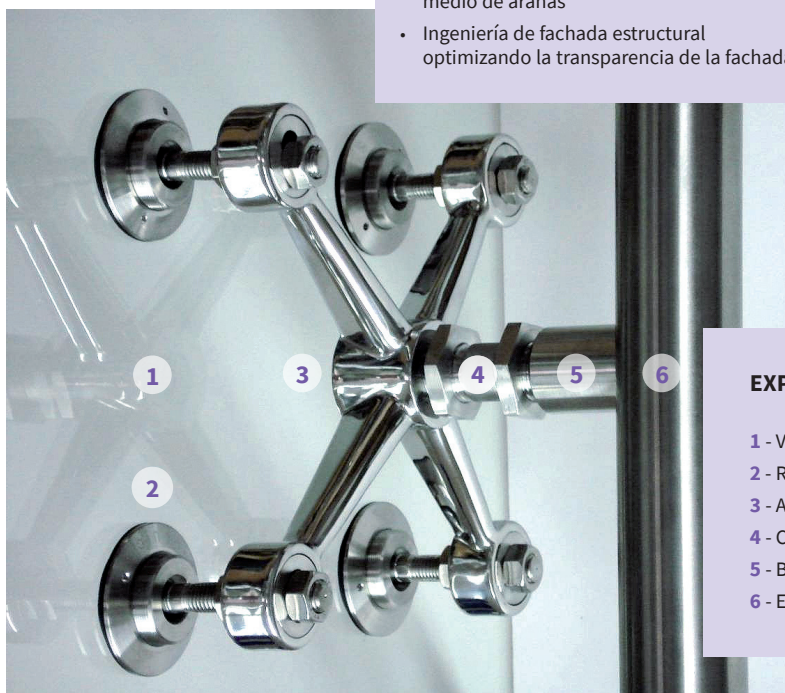

#### EXPLICACIÓN FUNCIONAL DEL SISTEMA 1 FITECHNIC

- 1 - Vidrio
- 2 - Rótula para unión de vidrio a la araña referencia 2421
- 3 - Araña 4 brazos referencia 2413
- 4 - Conector roscado de unión de araña a base soporte ref. 2426
- 5 - Base soporte de la estructura referencia 2427
- 6 - Estructura

3 SISTEMAS DE INSTALACIÓN

AISI-316

### SISTEMA 1

Araña + Tapa (FIX TP) + Conector (FIC 71)  
+ Base soporte (FITT)

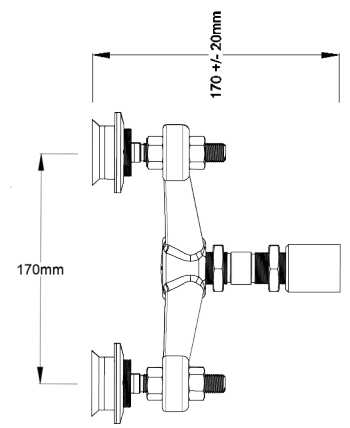
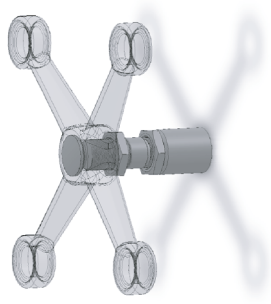

### SISTEMA 2

Araña + Tapa (FIX TP) + Arandela Interior (FIX AR)  
+ Tornillo M12 (FIEM 12)

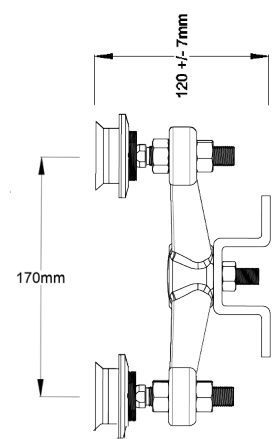
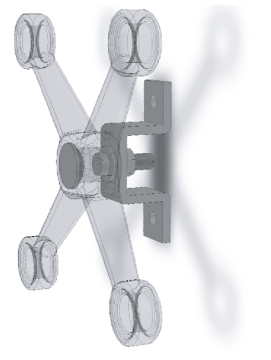

### SISTEMA 3

Araña + Tornillo M12 a M18 (depende del proyecto)

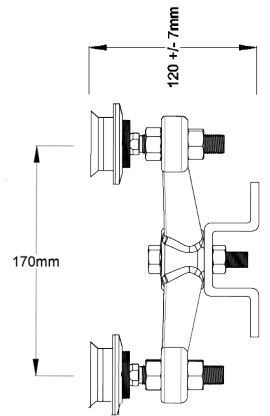
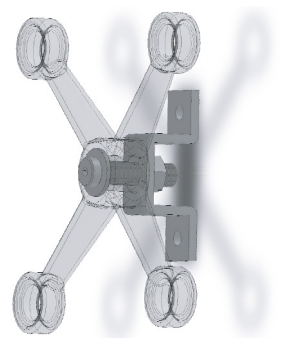

ARAÑAS

AISI-316

**ARAÑA DE UNIÓN 1 PUNTO 85 mm**

Acabados:

Inox brillo 2400 IB

**ARAÑA DE UNIÓN 1 PUNTO 102 mm**

Acabados:

Inox brillo 2400.1 IB

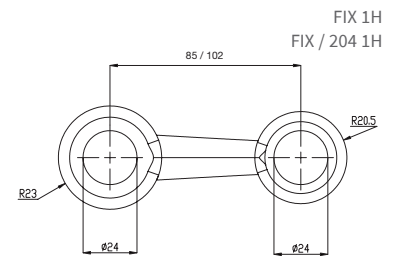

FIX 1H  
FIX / 204 1H

**ARAÑA DE UNIÓN 2 PUNTOS 170 mm**

Acabados:

Inox brillo 2401 IB

**ARAÑA DE UNIÓN 2 PUNTOS 204 mm**

Acabados:

Inox brillo 2401.1 IB

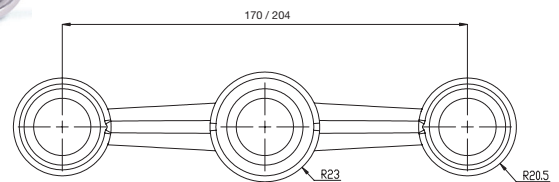

FIX 2H  
FIX / 204 2H

**ARAÑA DE UNIÓN 1 PUNTO 85 mm**

Acabados:

Inox brillo 2410 IB

**ARAÑA DE UNIÓN 1 PUNTO 102 mm**

Acabados:

Inox brillo 2410.1 IB

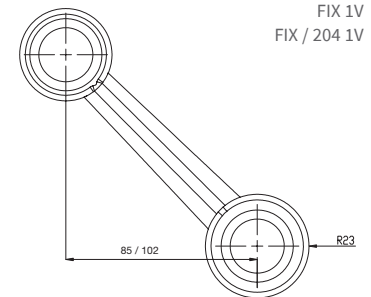

FIX 1V  
FIX / 204 1V

**ARAÑA DE UNIÓN 2 PUNTOS 170 mm**

Acabados:

Inox brillo 2411 IB

**ARAÑA DE UNIÓN 2 PUNTOS 204 mm**

Acabados:

Inox brillo 2411.1 IB

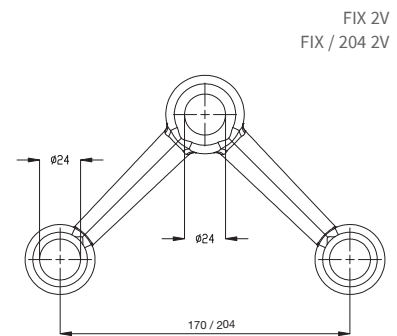

FIX 2V  
FIX / 204 2V

**ARAÑA DE UNIÓN 3 PUNTOS 170 mm**

Acabados:

Inox brillo 2412 IB

**ARAÑA DE UNIÓN 3 PUNTOS 204 mm**

Acabados:

Inox brillo 2412.1 IB

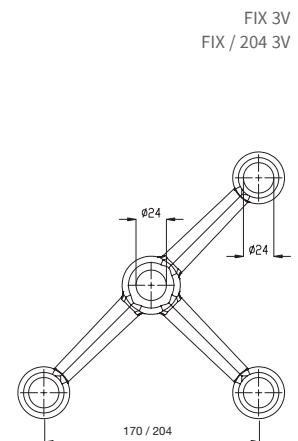

FIX 3V  
FIX / 204 3V



### ARAÑA DE UNIÓN 4 PUNTOS 170 mm

Acabados:

Inox brillo **2413 IB**

### ARAÑA DE UNIÓN 4 PUNTOS 204 mm

Acabados:

Inox brillo **2413.1 IB**

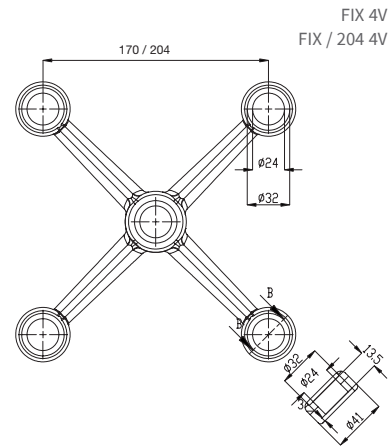

FIX 4V  
FIX / 204 4V

### ARAÑA FIJACIÓN LATERAL 170 mm

Acabados:

Inox brillo **2415 IB**

### ARAÑA FIJACIÓN LATERAL 204 mm

Acabados:

Inox brillo **2415.1 IB**

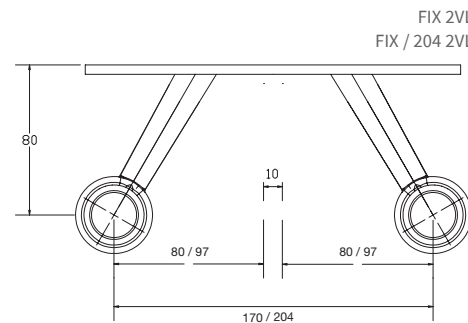

FIX 2VL  
FIX / 204 2VL

### ARAÑA FIJACIÓN LATERAL 80 mm

Acabados:

Inox brillo **2440 IB**

### ARAÑA FIJACIÓN LATERAL 100 mm

Acabados:

Inox brillo **2440.1 IB**



FIX 1HL  
FIX / 204 1HL

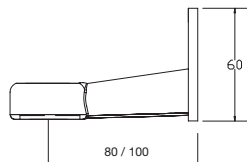
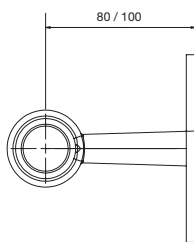

### ARAÑA ADAPTADOR DE ESQUINA

Acabados:

Inox brillo **2414 IB**



FI RL

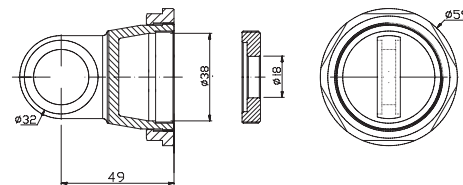

### TETÓN 100 mm M14

Para embutir en estructura y colocar rótulas fijas en la instalación de barandillas

FITT100

**2417**

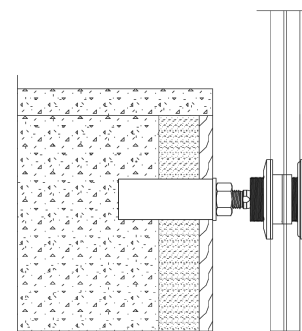

**ARAÑA SIN TALADROS  
PARA DOBLE ACRISTALAMIENTO**

PF-H

Adaptable a refs. 2426 y 2427

Acabados:

Inox brillo	2442 IB
-------------	---------

\*Bajo pedido

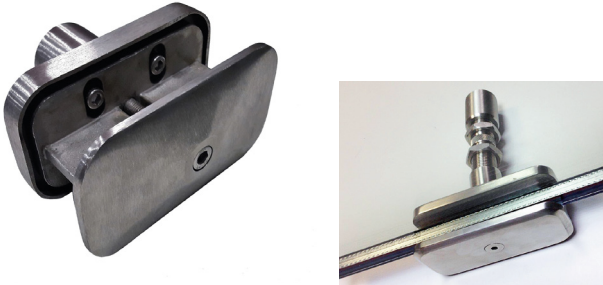

**ARAÑA SIN TALADROS  
Ø 80 mm**

PF-C

Acabados:

Inox brillo	2443 IB
-------------	---------

\*Bajo pedido



**RÓTULAS ARTICULADAS**

AISI-316

**RÓTULA ARTICULADA**

RE1221 M14

Vidrio 12/21 mm

Incluye 2 arandelas y dos tuercas DIN439

2421

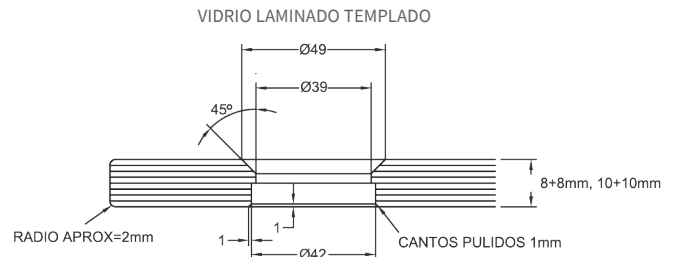
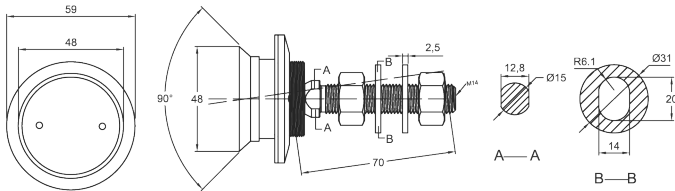
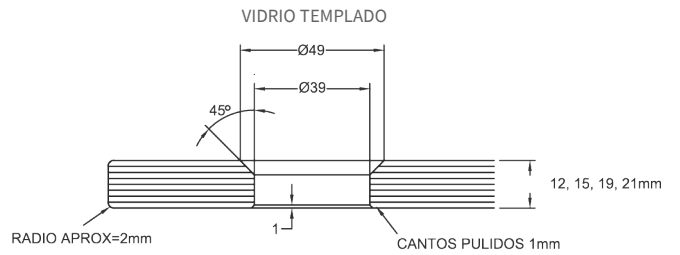

**RÓTULA ARTICULADA  
CON TAPÓN EXTERIOR**

RT1221 M14

Vidrio 12/21 mm

Incluye 2 arandelas y dos tuercas DIN439

2422

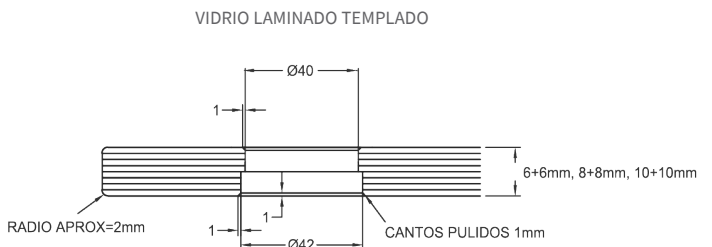
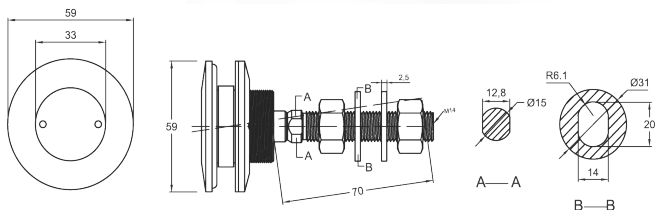
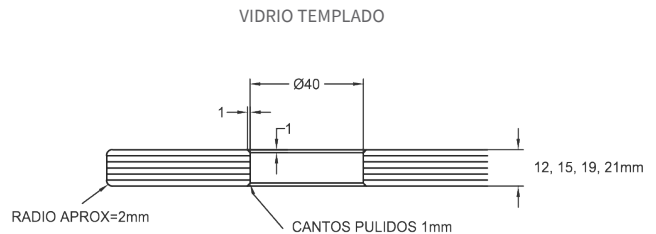



## RÓTULA ARTICULADA

Vidrio de cámara 28/36 mm

Incluye 2 arandelas y dos tuercas DIN439

2423

## SEPARADOR DE NYLON PARA CÁMARA

2423.1

\*Especificar grosor de cámara

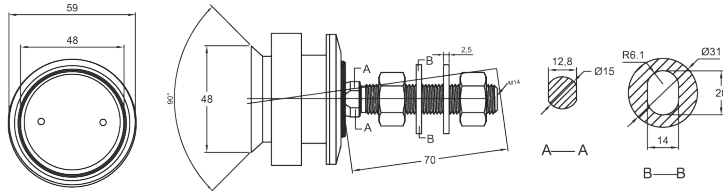

RD2836 M14  
FISEP

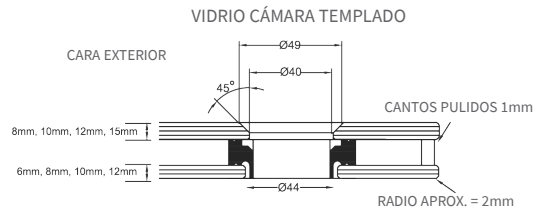

## VIDRIO CÁMARA LAMINADO TEMPLADO

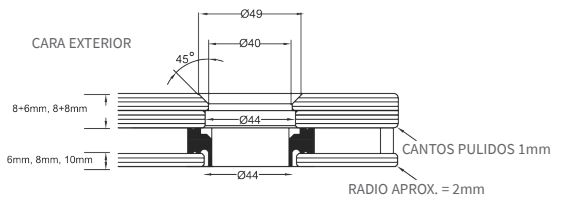

## RÓTULA ARTICULADA

Vidrio 10/21 mm

Incluye 2 arandelas y dos tuercas DIN439

Fijación exterior

2424

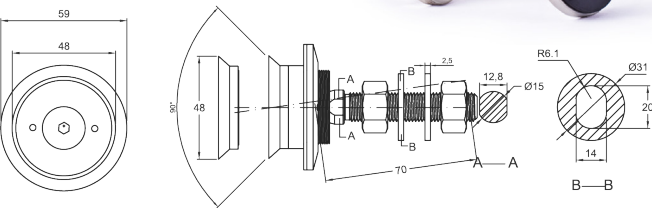

RCE1021 M14

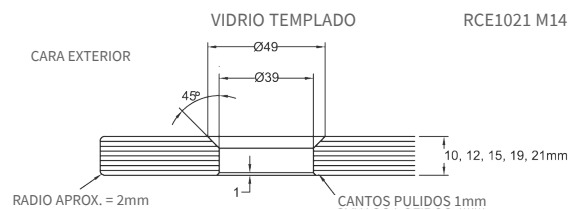

## VIDRIO LAMINADO TEMPLADO

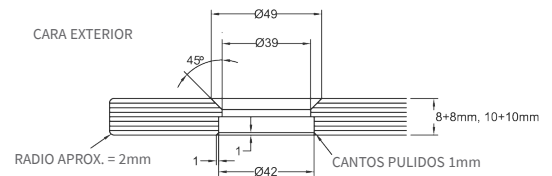

## RÓTULA ARTICULADA CON TAPÓN EXTERIOR

Vidrio 10/21 mm

Incluye 2 arandelas y dos tuercas DIN439

Fijación exterior

2425

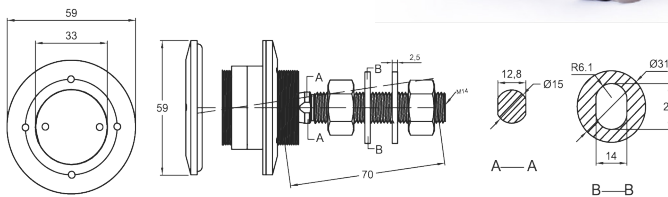

RCT1021 M14

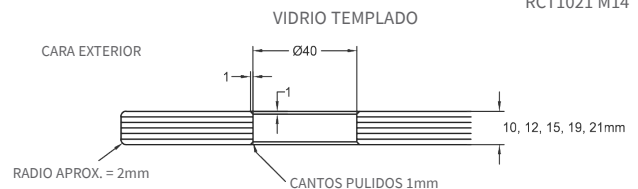

## VIDRIO LAMINADO TEMPLADO

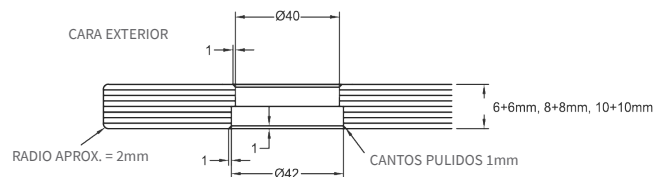

## RÓTULA ARTICULADA CON TAPÓN EXTERIOR

Vidrio de cámara 28/36 mm

Incluye 2 arandelas y 2 tuercas DIN439 y separador de nylon

2428

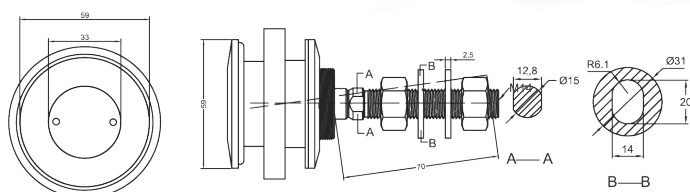

RDT2836 M14

## VIDRIO CÁMARA TEMPLADO

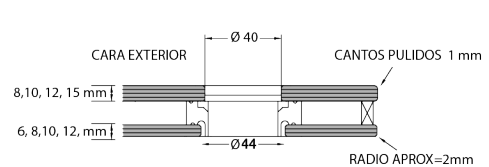

## VIDRIO CÁMARA LAMINADO TEMPLADO

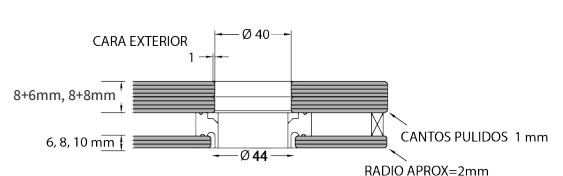



**RÓTULA ARTICULADA PARA EMBUTIR EN LAMINADO O CÁMARA**

Vidrio interior 10/12 mm  
 Vidrio exterior según proyecto  
 Incluye 2 arandelas y 2 tuercas DIN 439

2429

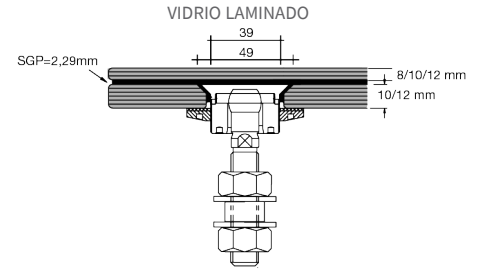
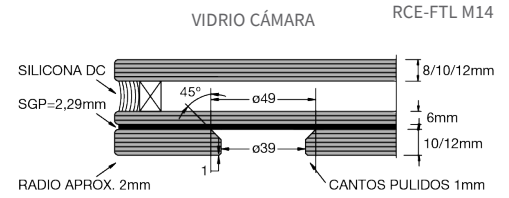
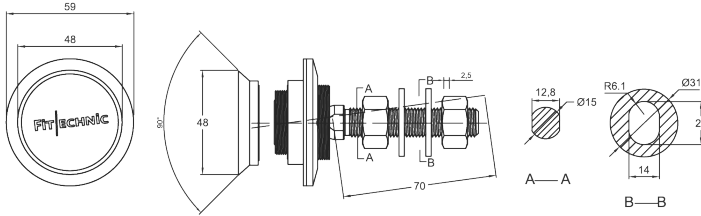

**RÓTULA ARTICULADA PARA ADHESIVO**

Adhesivo estructural tipo UV, DP490, TSSA  
 Sin taladro

2436

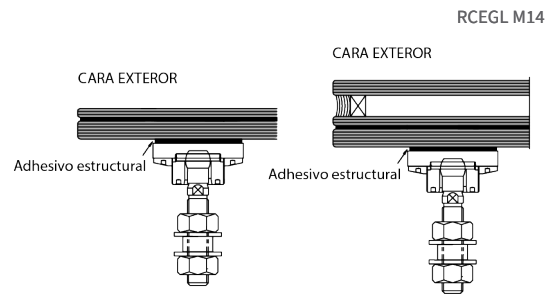
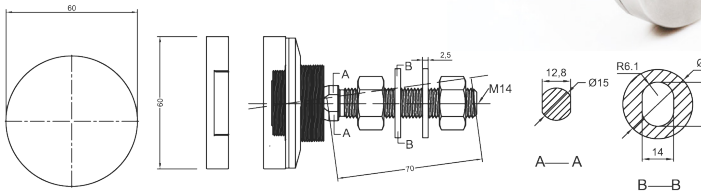

RÓTULAS FIJAS

AISI-316

**RÓTULA FIJA**

Vidrio 10/16 mm  
 Incluye 2 arandelas y 2 tuercas DIN439  
 Fijación exterior

2433

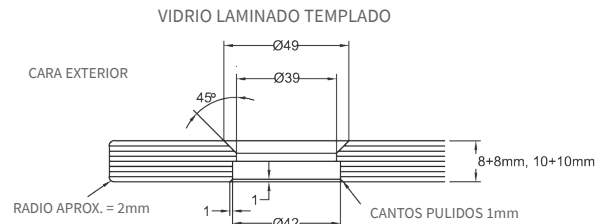
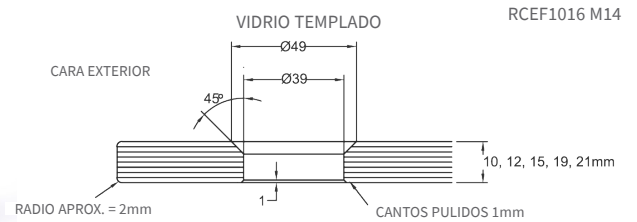
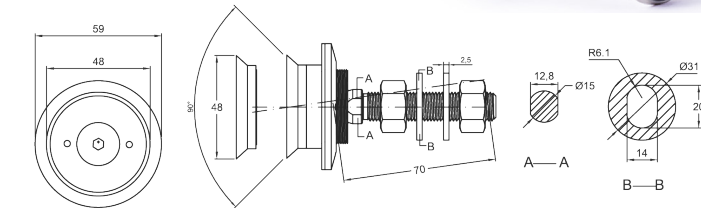

**RÓTULA FIJA CON TAPÓN EXTERIOR**

Vidrio 10/21 mm  
 Incluye 2 arandelas y 2 tuercas DIN439  
 Fijación exterior

2434

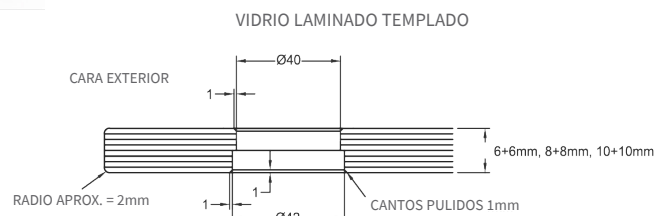
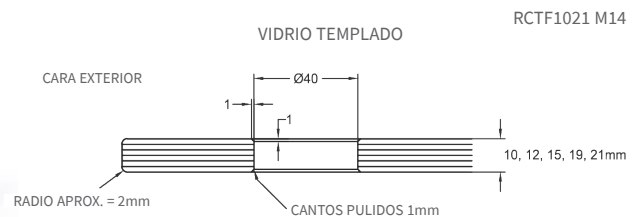
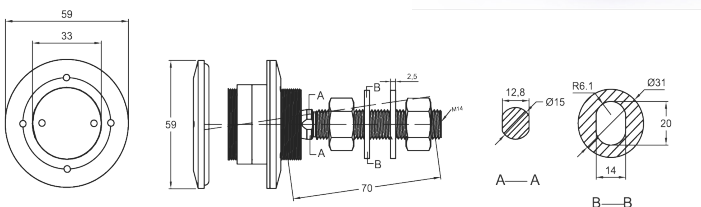

COMPLEMENTOS

AISI-316

### BASE SOPORTE

Para sujetar a la estructura junto con ref. 2426 en Sistema 1

2427

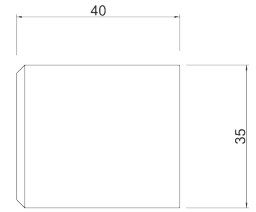
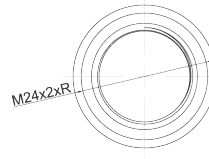
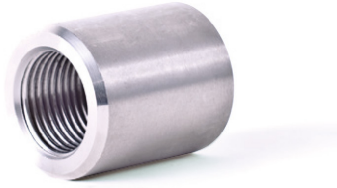

FI TT

### CONECTOR / TORNILLO DE UNIÓN DE ARAÑA A ESTRUCTURA M24

Doble rosca derecha/izquierda y dos tuercas de doble bloqueo DIN439 Sistema 1

2426

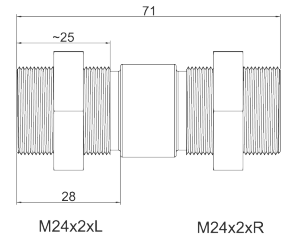
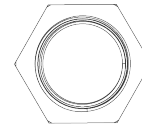

FI C71

### BASE OMEGA PARA SISTEMAS 2 Y 3

2441

Tornillo no incluido Ref. 2416 / 2416.1

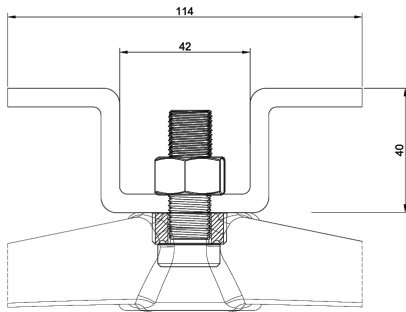

### BASE SOPORTE PARA SISTEMA 1

2444

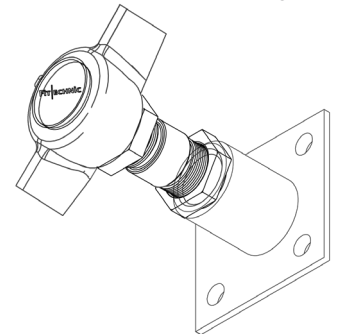
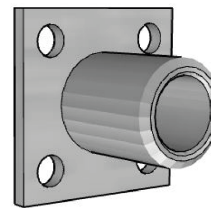

FI CTM24

### TORNILLO PARA SISTEMAS 2 Y 3

FIEM14

M14x50 2416.1

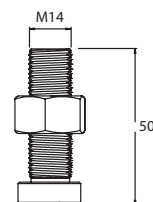

Ref. 2416.1

### ARANDELA INTERIOR PARA SISTEMA 2

FIXAR M14

M14 2419.1

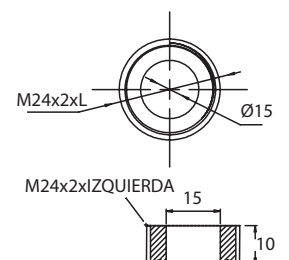

INSTALACIONES CON CABLE

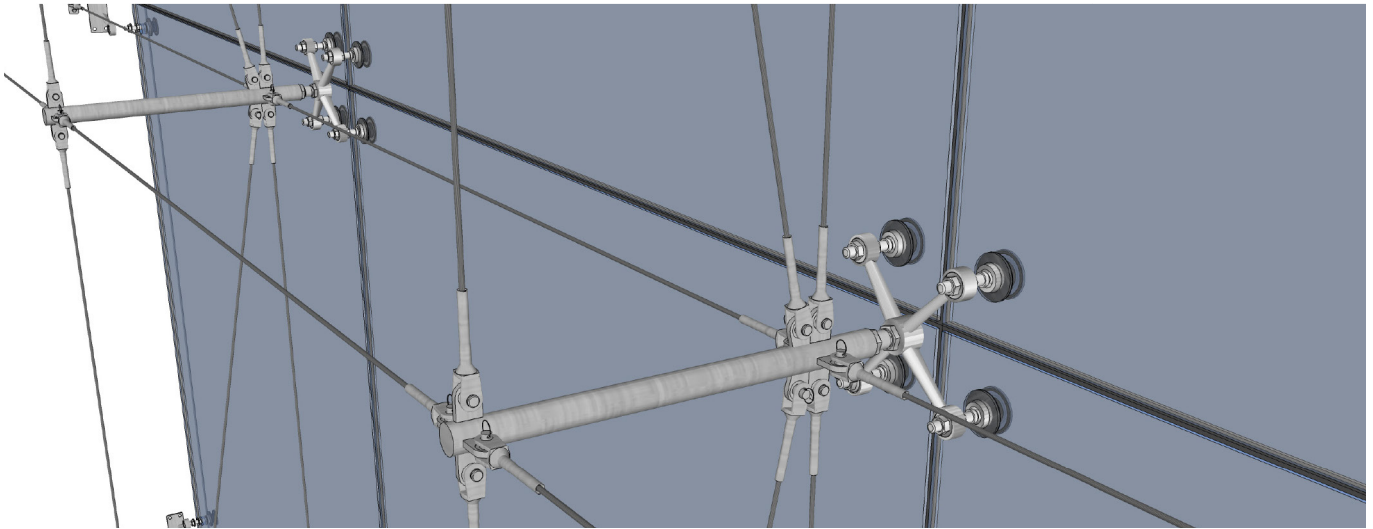

**ESTRUCTURAS TENSIONADAS**

Una fachada de acristalamiento estructural con cables de acero inoxidable, sin estructuras metálicas. Utilizando arañas conectadas con varilla y unidas a través de los cables tensados podemos obtener la máxima transparencia y una óptima estética.



**FI-BR**

Biela en acero inoxidable AISI316 con placas de acero para horquillas, para la conexión de arañas y cables/varillas.

**FI-VAR**

Vástago en acero inoxidable AISI316 con tensor y 2 horquillas de diámetro variable

**FI-CAB**

Cable en acero inoxidable AISI 316 con tensor y 2 horquillas de diámetro variable

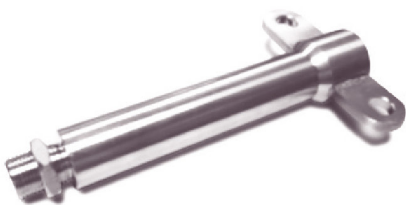

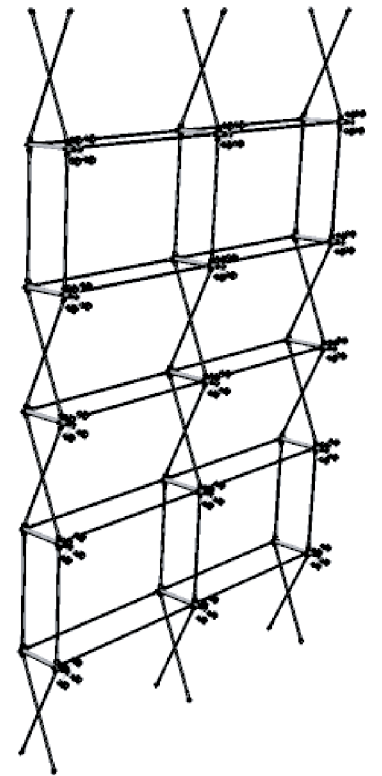
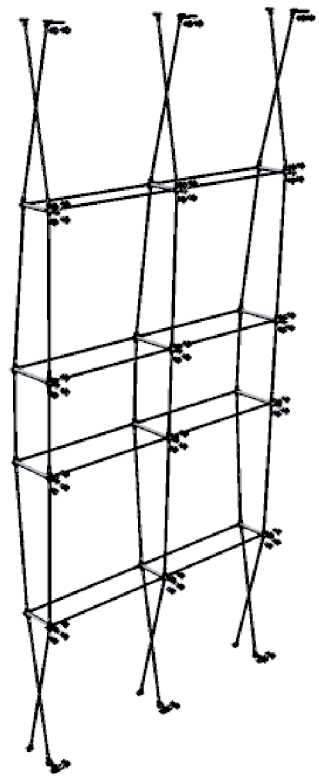

SISTEMA F12H-ROD

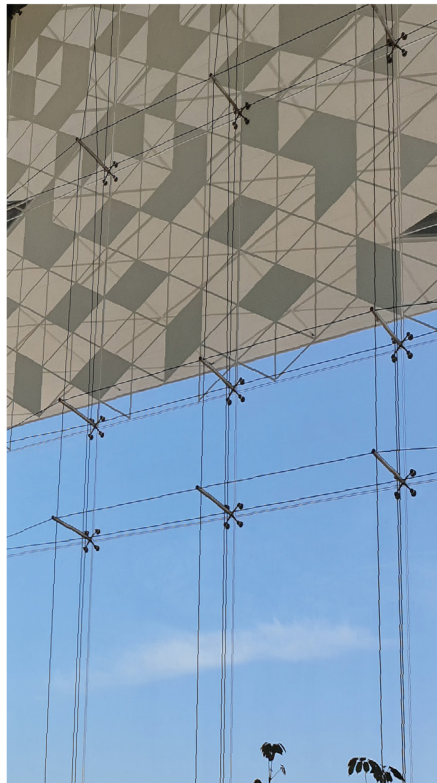

SISTEMA F14V-CAB



SISTEMA F14V-ROD

## SILICON GLASS **NOVEDAD**

Silicon Glazing es un sistema híbrido de muro cortina con doble fijación:

- Fijaciones mecánicas ocultas
- Silicona estructura

Este sistema se puede aplicar a cualquier tipo de vidrio (doble IGU, templado, laminado, esmaltado o comunes) y materiales de revestimiento de fachadas (acero inoxidable, acero, aluminio, piedra, madera).



- CE Marking / EN 13830
- ISO 9001 Quality Management
- Air permeability class: AE (\* max)
- Water tightness class: R750 (\* max)
- Wind load test: 2000 / 3000Pa
- Impact class: I5 / E5
- Ucw = from 1.0 W / m2.K

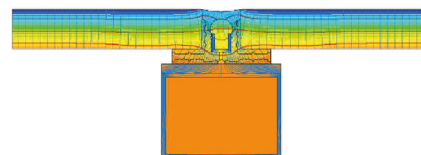

### APLICACIONES SG-12

Vidrio simple laminado o templado para interior o aplicación de fachadas exteriores, cubiertas y marquesinas.

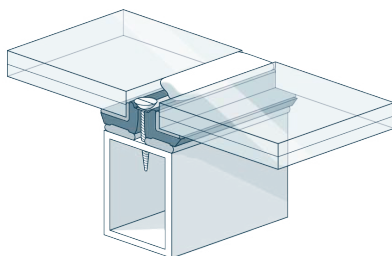

### APLICACIONES SG-22+

Vidrio doble acristalamiento para fachada exterior y aplicación de cubiertas, con rotura de puente térmico.

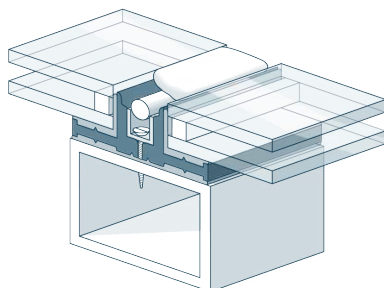

### PROYECTOS PERSONALIZADOS

Fachadas y cubiertas especiales con SG12, SG22+ o otros perfiles de silicona HTV fabricados a medida.

