



VERTICALITY LIGHTING

2025 PROFESSIONAL CATALOG



Access
the
inaccessible®



Glass window maintenance, Tour Crayon de la Part-Dieu, Lyon, France
© 2024 Petzl Distribution - Vuedici.org - Bleu Ciel Services (BCS) - Tour Crayon de la Part-Dieu

What makes the job of professionals easier? Having access to the best solutions and knowing with confidence that they can rely on their equipment to get the job done right. That's why we continue to develop our Petzl expertise and know-how: to enable safer progression for customers who work in hazardous and/or dark environments. We've been driven by the spirit of innovation since day one, and the work we do today is with the standards of tomorrow in mind — so that every customer can access their own inaccessible. Explore the catalog and get to know our complete range, including new 2025 products! Happy reading and all the best!

The Petzl Team

We Are Petzl

Petzl Across the Globe

Our Pillars

Corporate Social Responsibility

Key New Products



VERTICALITY

General Principles of Work at Height

Rope Access and Confined Space

Tree Care

Energy and Networks

Framing and Roofing

General Rescue Principles

Self-Rescue

On-Site Rescue

Technical Rescue

Cable Lift Evacuation

ePPEcentre Application

Helmets

Harnesses

Lanyards and Energy Absorbers

Mobile Fall Arresters

Connectors

Descenders

Rope Clamps

Pulleys

Anchors

Ropes

Packs and Accessories

Kits

Customizable Products

LIGHTING

A Range for Every Use

The Petzl Difference

Brightness and Burn Time

Potentially Explosive Atmospheres

IP and IK Protection Index

Headlamp Specifications

Powerful and Intelligent Headlamps

Compact and Durable Headlamps

Ultra-Compact and Versatile Headlamps

Petzl Solutions for Outdoors and Tactical Operations

The Petzl Foundation

Petzl.com

We
are **PETZL.**

This is
how we **see the world.**

We are committed to **creating safer places.**

For those who **work and play**
in the vertical and dark worlds.

For those who want **to access**
their own inaccessible every day.

We are **independent** and completely
free to choose our own endeavors.

To maintain **industrial excellence**,
paying attention to our impact.

To be pioneers in the pursuit of
perpetual innovation.

Sharing, educating, building. **Together.**

This is
how we **see the world.**

We
are **PETZL.**



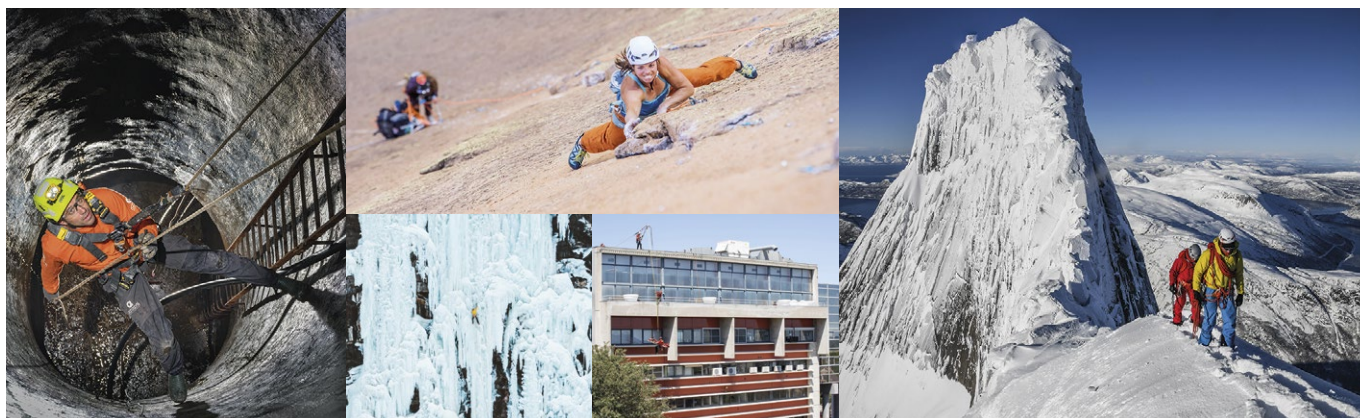

Access the inaccessible[®]

“Accessing the inaccessible” is the driving force behind everything you do, whether you are moving towards a summit or descending into darkness. You're determined to get to ever-greater heights and through ever-deeper shadows. And you're always searching for better tools to do it: tools with superior performance, tools that are more reliable, tools so comfortable and ergonomic that they disappear into your hand. At Petzl, we share your determination. We've built our entire design and manufacturing philosophy around exceeding your needs in the field. It's what we've been doing for 50 years, and what we'll continue to do for years to come.



Access the inaccessible video



Petzl Across the Globe

Petzl is a family business that, over the years, has become the largest European manufacturer of personal protective equipment for those who work and play in darkness or at height. All of our products are invented and developed at our headquarters in the heart of the French Alps.

Key Stats

The brand is present in over **55** countries.

85% of sales are made internationally.

More than **9** million products are sold every year.

10,000,000 people use Petzl personal protective equipment every day.



An International Presence

- Headquarters in the French Alps, in the town of Crolles
- American subsidiary in Salt Lake City, Utah
- Local subsidiaries: Austria, Benelux, Denmark, Finland, France, Germany, Italy, Japan, Norway, Spain, Sweden, Switzerland, UK, and China

1,200 employees across the globe.

4 production sites: **3** in France and **1** in Malaysia.

Petzl subsidiaries and sales agencies
Petzl Distributors

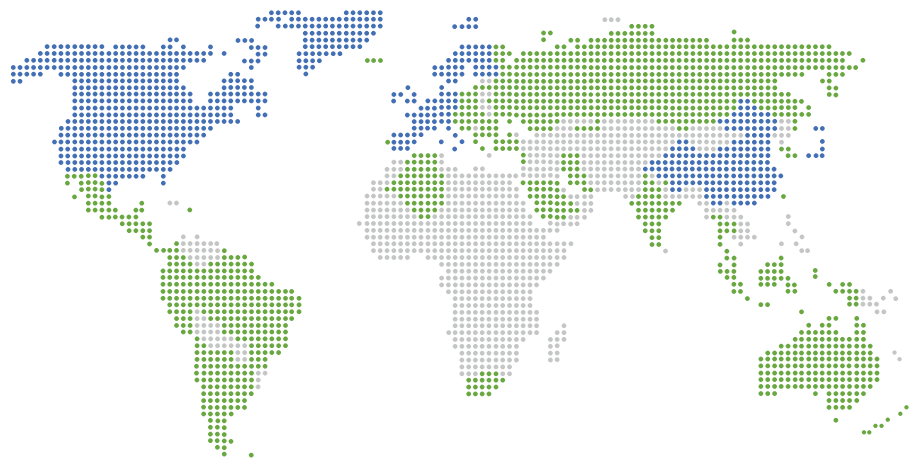

About Petzl

The Values That Motivate Us

For 50 years, Petzl has been built around four pillars, four fundamental values that motivate every decision we make: remaining a stable family business, encouraging innovation to imagine the best solutions, insisting on industrial excellence with the goal of zero defects, and remaining engaged with our communities by providing global best practices.

Learn more about each of our pillars.

■ 1. Family Ownership

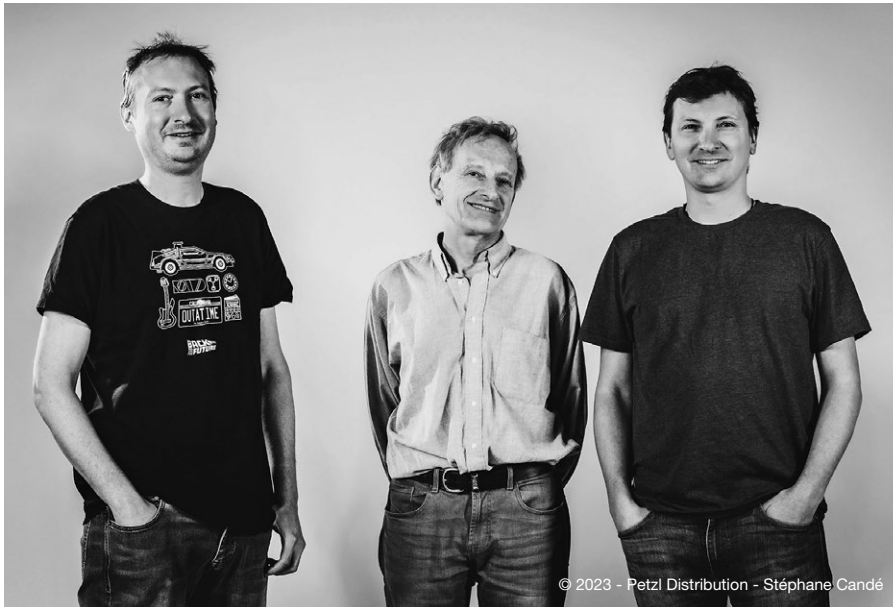

Sébastien, Paul, and Olivier Petzl

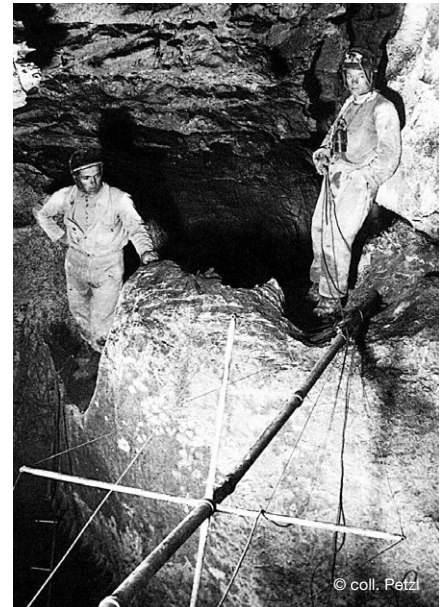

Fernand Petzl and Daniel Gagneur in front of a scaling pole



Fernand in his workshop

Our story begins in the 1930s in southeastern France

That was when craftsman Fernand Petzl was introduced to caving. Back at his workshop after each excursion to the depths, Fernand imagined new tools for exploring darkness and heights. In 1968, he marketed his first products; in 1970, Petzl was born.

For decades, the Petzl family has built a stable environment that fosters creative solutions and industrial excellence. The new generation is rooted in these principles and ready to make new discoveries.

The Petzl family business is not listed on the stock market. We're proud of our independence; we make our own choices, take responsibility for our decisions, and maintain a long-term, sustainable vision for the future. The confidence and satisfaction of our customers, our dealers, and our partners drives everything we do.



© 2023 - Petzl Distribution - Marc Daviet



© 2021 - Petzl Distribution - VJedlics.org

2. Innovative Spirit



Innovations That Challenge Convention

With the introduction of the first headlamp in 1973, the legendary GRIGRI assisted blocking belay device in 1991, and the MAESTRO rescue descender in 2019, Petzl ingenuity has always pushed standard practices forward. Since the creation of Petzl in 1970, our objective has always been to make progressing in dark or vertical spaces safer and more comfortable.

Going Farther

As passionate pioneers, we delight in creating new opportunities for our users to venture into ever more committing terrain — to go farther and higher, to work more efficiently, to maximize safety and to make what was inaccessible today accessible tomorrow.



Simplicity, Durability, Efficiency

In every tool we design and construct, we prioritize simplicity, durability, and efficiency. For Petzl, being a pioneer has meant 50 years of passion, expertise, innovation, and continuous improvement. This approach to our craft and our business has allowed us to serve as a global expert, as we did in 2006 with the conception of the EXO personal escape system. At the request of, and in collaboration with, the firefighters of New York City, we were able to design an efficient solution that would allow easy escape in critical situations. It's an achievement that has been recognized with several awards, including best invention of the year by Time Magazine.

The Evolution of Petzl Headlamps

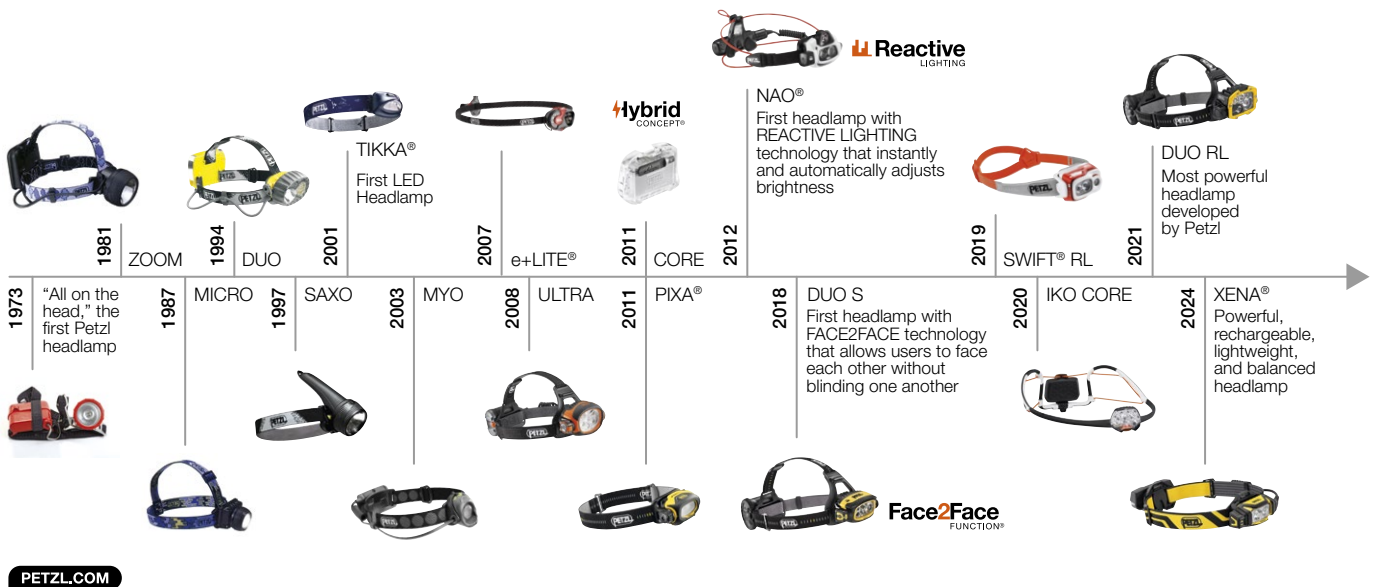

■ 3. Industrial Excellence

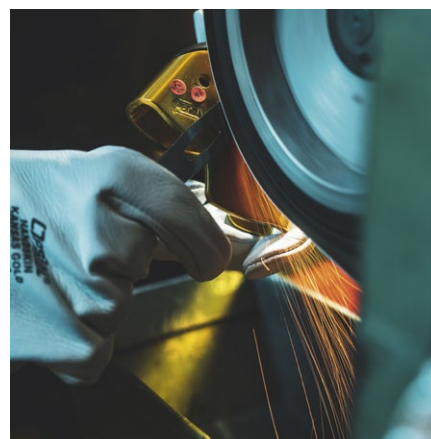

© 2020 - Petzl Distribution - Stéphane Candé

Beyond the Standards

We have a deep responsibility to the people who trust us with their lives, and we develop, test, and qualify all of our products above required standards. Our design center, based in France, integrates all crafts that are related to the creation of products: mechanical, textile, electronic, optical, and technological. From the design and prototype phases, the reliability of a product and the safety of the user are continuously evaluated, with particular attention to risks of use.

With labs dedicated to product testing, we conduct dynamic fall and impact resistance tests, perform cyclical testing, and evaluate performance, as well as beam quality and burn times of our headlamps. This process includes rigorous field testing in order to test the ergonomics and reliability during real-world use.



© 2023 - Petzl Distribution - Stéphane Candé

Zero Defects - PPE (Personal Protective Equipment)

Reliability is at the center of our concerns: our goal is for our products to consistently function at the same level of excellence. Our objective is to allow zero defective products to leave our facilities, which involves processes with significant extra costs at every stage of production.

As we navigate an increasingly globalized economy, we go to great lengths to support our distributors and dealers, and we are heavily involved in the fight against counterfeit products.

Production and Inspection

Petzl's production sites are located in France, in the towns of Crolles, Eybens, and Rotherens, as well as in Rawang, Malaysia. Remaining competitive and keeping the majority of our production in France means that we continuously optimize our production lines and reduce our waste. This production infrastructure is complemented by long-term partnerships with key suppliers in Europe and Asia.

Our purchasing and quality control teams work closely with suppliers, ensuring to the best of our abilities, product reliability and quality that meets or exceeds our strict requirements. Quality inspection is present throughout every step of the production process: machine inspection of operations, human inspection at key points, further reinforcement by error-proofing systems and final individual inspection of each product.

We regularly audit the methods, quality management systems, and CSR practices (Corporate Social Responsibility) of our suppliers and strategic partners, especially when it comes to their employees.



© 2023 - Petzl Distribution - Stéphane Candé

■ 4. Community Engagement



Using Our Expertise to Serve Communities

Sharing technical knowledge and appropriate product uses is at the heart of what we do at Petzl. We produce high-quality technical content that is available to everyone and utilized by the different communities that we serve. With a focus on maximizing safety, this content is updated and enriched throughout the lifespan of our products to keep our customers informed and moving forward while they practice their sport or do their job.

International Collaboration

Across the world, we have partnerships with iconic athletes, influential figures, professionals who work in extreme conditions, NGOs, certifying bodies, and training centers operated by leading experts in the field. These collaborations help us co-create a world where we can all learn, share, and flourish. They also make it easier to promote best practices and standard uses. At the heart of our collaborations is always a passion for exploration, for a job well done, and for the pursuit of the inaccessible.



The Petzl Foundation, An Integral Part of Petzl

Through the Petzl Foundation, we support and initiate projects that help prevent accidents, preserve the environment, and improve knowledge of the natural world around us.

More information about the Petzl Foundation can be found on page 106.

“More than ever before, we’re acutely aware that the choices we make today will have a lasting impact on the environment and will actively shape our own futures and the futures of our children. We’re committed to using our creativity and our capacity to innovate in service of sustainably reducing our impact in a continuous drive for improvement.”

Sébastien Petzl, Director of CSR



© 2023 - Petzl Distribution - Peignée Verticale

Our approach to CSR is pragmatic, collaborative and positive. It's built on concrete actions, feedback from our stakeholders, and is solution-oriented, to encourage our teams and community to take action.

The safety and satisfaction of our customers remains our top priority. Beyond that, we're striving to create a more sustainable future. Petzl has launched projects to improve our own economic, environmental, and social practices, as well as the practices of our suppliers in order to:

- Reduce our carbon intensity
- Reduce, reuse, and recycle our waste
- Improve our employee satisfaction
- Improve the labor conditions of our suppliers

Corporate Social Responsibility

Four Actionable Commitments

At Petzl, we're focused on four commitments that respond to the primary concerns of over 2,000 of our internal stakeholders (employees, subsidiaries, family shareholders) and external stakeholders (clients, users, suppliers, associations, and NGOs). We are manifesting these four commitments through hands-on projects with measurable outcomes.

■ Reduce Our Carbon Intensity

In 2020, we worked with Carbone 4 to measure the comprehensive carbon impact of our operations in 2019 — from the extraction of raw materials to the end of a product's life. Our footprint was equal to 45,000 metric tons of CO₂. Three areas accounted for 75% of our emissions: raw materials (34%), transport of goods (24%), energy used to power our headlamps (17%).

In 2021, we created initiatives to reduce our carbon footprint: prioritize the use of materials with the least impact, improve the durability and reparability of our products, shrink the distances our goods travel, and reduce our energy consumption.

By 2030, our goal is to reduce our total carbon footprint by 50% per euro in sales.



© 2023 - Petzl Distribution - Stéphane Candé

■ Reduce, Reuse, and Recycle Our Waste

The waste from our industrial and commercial operations produces a variety of pollutants.

We're taking action in our factories, warehouses, and offices to reach three objectives by 2025:

- Eliminate single-use plastics in our packaging and supply chain
- Reuse 50% of our cardboard and pallets, recycle the rest
- Recycle 80% of our metal, plastic, cardboard and wood waste, put the rest towards energy recovery

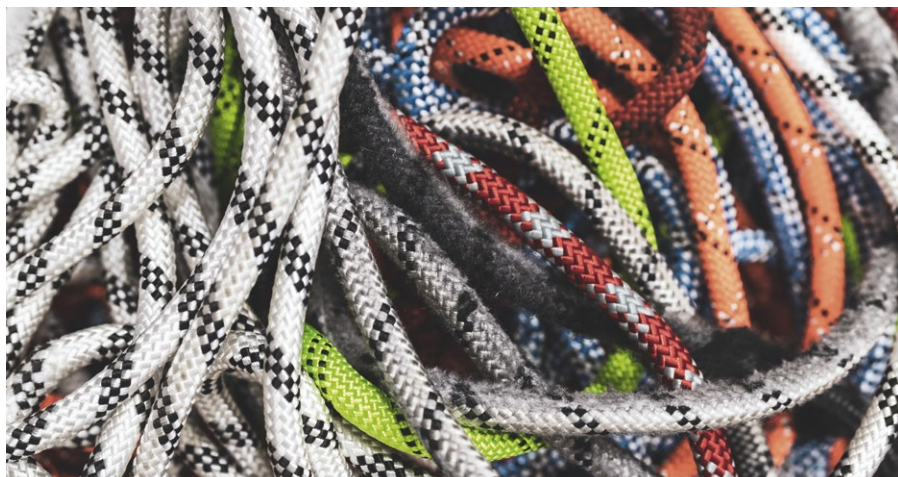

© 2023 - Petzl Distribution - Stéphane Candé

[Learn more](#)

■ Improve Our Employee Satisfaction

Our strong and consistent growth, coupled with the complex issues of the pandemic, has the potential to affect employee health. In 2021, we evaluated the satisfaction of all Petzl employees in France using the Wittyfit platform. The survey covers topics including organization and work load, autonomy, work/life balance, recognition, as well as purpose and values.

Using the results, we created action plans to improve satisfaction — some carried out by leadership and others co-created and led by the teams.

In 2023, this satisfaction audit was extended to all Petzl employees on a global level.



© 2023 - Petzl Distribution - Stéphane Candé

■ Improve the Labor Conditions of Our Suppliers

Since 2010, our responsible purchasing initiative has aimed to ensure that all our suppliers comply with the Petzl code of conduct. This code aligns with International Labor Organization (ILO) directives:

Our objectives are to improve social, environmental, health, and safety practices at all of our suppliers.

We've created an annual evaluation of CSR practices for suppliers representing 80% of our purchases. We've offered reinforced support for 25% of our suppliers in their continued improvement plans. We are also collaborating with other manufacturers to combine our audit efforts and reaffirm our CSR standards for common suppliers.

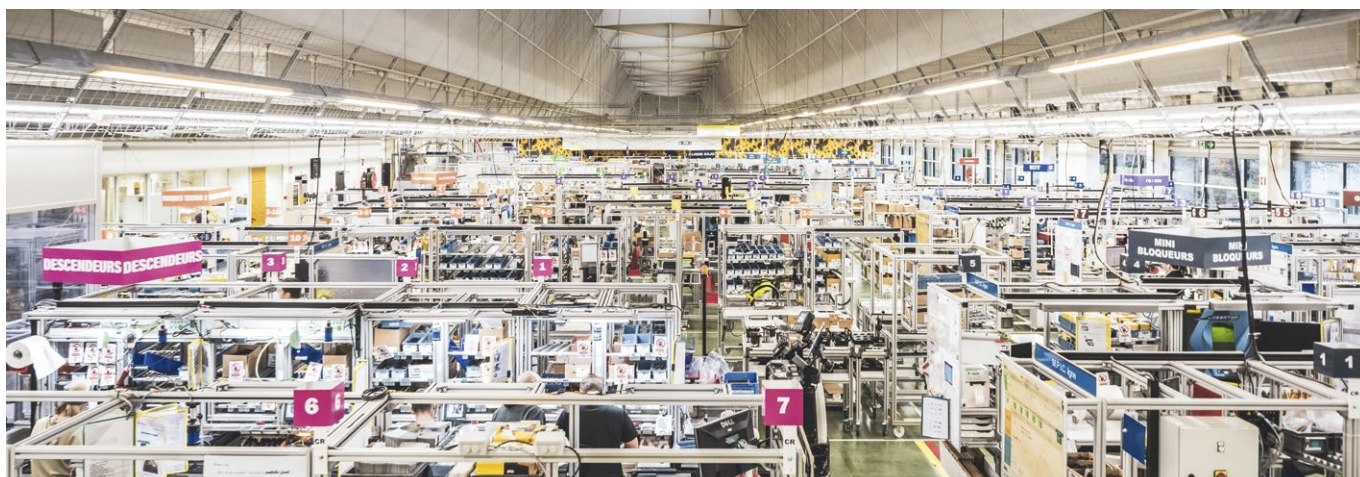

© 2023 - Petzl Distribution - Stéphane Candé

NEW
2025

Key New Products

Harnesses for Fall Arrest, Work Positioning, and Suspension

Designed for professionals who work in vertical environments and various worksites, the new AVAO harnesses are especially versatile and offer an unmatched level of comfort. Designed for fall protection, work positioning, and suspension, they're built to serve the most demanding professionals for every task.



AVAO® / AVAO® FAST
European Version



AVAO® / AVAO® FAST
International Version



AVAO® SIT / AVAO® SIT FAST



TOP



© 2024 Petzl Distribution - Lafouche



© 2024 Petzl Distribution - Vuedici.org

Rope Access Harnesses

For all professionals who spend their days working, descending, and ascending on a rope, the new range of ASTRO harnesses provides the best solution for the job! Plus, to adapt to different situations and provide the highest level of comfort while suspended for long periods of time, the range now includes two work seats.



ASTRO®
European Version



ASTRO®
International Version



ASTRO® SIT



TOP CROLL®



PODIUM



LITEPOD

NEW
2025

Key New Products

Connectors

Introducing two new products in the carabiner range this year. First in the line-up: the VERTIGO TWIST-LOCK, specifically developed to equip progression lanyards, offering excellent grip and automatic locking. Next, we have the OMNI. With a semi-circle design, it's the superior solution for closing certain harnesses or connecting a ventral rope clamp.



VERTIGO TWIST-LOCK



OMNI



© 2023 Petzl Distribution - Vuedici.org

Low Stretch Kernmantle Ropes

With the new BEAM 11 mm and VECTOR 12.5 mm ropes, rescue teams have the ideal solution for operations that require excellent grip and great strength. And when it comes to the new FLOW 11.8 mm and CONTROL 12.5 mm, they are sure to please the most demanding arborists.



BEAM 11 mm



VECTOR 12.5 mm



FLOW 11.8 mm



CONTROL 12.5 mm

Compact and Durable Headlamps

After many years of loyal service, the PIXA headlamps are getting an update. What remains is what they've always done best: versatility, durability, and ease of use. And they're now even brighter!



PIXA headlamp



PIXA® R



PIXA®



PIXA® Z0



VERTICALITY





GENERAL PRINCIPLES OF WORK AT HEIGHT

Warning

- You must have understood and retained the information from your products' Instructions for Use to be able to apply the techniques presented in this document.
- Learning appropriate techniques and methods of protection is your own responsibility. Petzl solutions are given for information purposes only, with no guarantee of their effectiveness in your specific working situation. The relevance of these solutions varies by context, so always carry out your own risk assessment in the field
- Mastering the techniques presented here requires specific training and practice. Work with a specialized organization for all of your training activities.

General Information About Falls

The risk of falling is a key concept to master when working at height. The severity of a fall depends on independent factors:

• The weight of the user, including equipment:

The greater the weight, the more energy to be dissipated during the fall.

• The length of the fall:

The longer the fall, the more energy to be dissipated during the fall. The risk of hitting an obstacle is also greater.

• The position relative to the anchor:

When the worker moves above their anchor, the severity of the potential fall increases.

The fall factor concept is sometimes used to describe the worker's position relative to the anchor and the severity of the fall. This concept applies to climbing, restraint, or work-positioning situations, when a dynamic rope lanyard is used.

Precautions for the type of system used: the Instructions for Use specify the limitations on use of equipment, particularly in terms of fall distance and the worker's position relative to the anchor.

Restraint

A restraint system limits the work zone, to help prevent the worker from entering an area that may present a fall risk.

This system is not designed to arrest a fall from height.

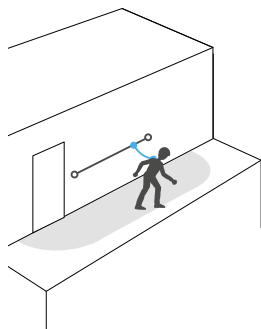

Fall Arrest

The fall-arrest system is a belay system that is independent of the means of progression or work positioning.

The fall-arrest system prevents the user from falling to the ground in the event of a fall. Its role is to arrest the fall while limiting the impact force experienced by the user. It must therefore be used with enough clearance to allow for an unobstructed fall.

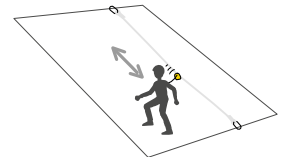

Work Positioning

A work-positioning system supports the user and allows them to be precisely positioned with the weight on their feet.

This system is not designed to arrest a fall; the user must keep their body weight on the positioning system.

The work-positioning system must be used together with a fall-arrest system.

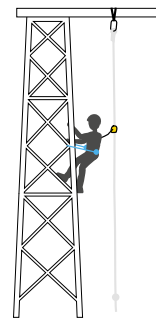

Suspension

The user is working while suspended when they no longer have any weight on their feet, but are supported primarily by the harness. The load is thus shared between the waistbelt and the leg loops/seat.

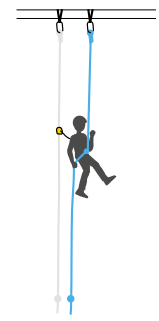

Impact Force

A fall-arrest system helps limit the impact force sustained by the user.

It is typically made up of an energy absorber that tears in order to limit the forces over a given stopping distance.

A dynamic rope lanyard has a low capacity for energy absorption. Its use requires taking great precautions: reducing the potential fall distance and staying in a work position below the anchor.

A webbing lanyard or a cable with no capacity for energy absorption cannot be used to arrest a fall.

Example for 100 kg

JANE or PROGRESS lanyard without energy absorber

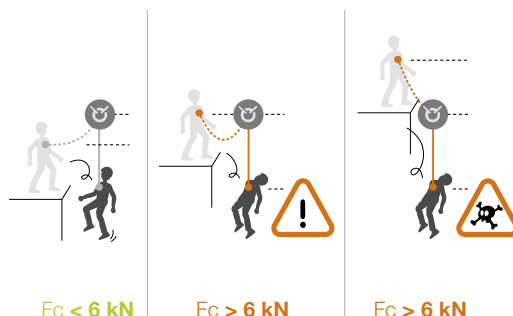

Lanyard with ABSORBICA-I or Y energy absorber

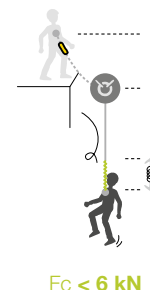

Clearance

Clearance is the minimum amount of clear space below the user that prevents the user from hitting an obstacle in the event of a fall.

Clearance takes into account:

- Weight of the user
- Length of the fall
- Tearing length of the energy absorber
- Average height of the user
- Safety margin of 1 meter

Clearance Value

The tearing length of the energy absorber, depending on the fall, can only be known based on the manufacturer's information; this is why a clearance estimate is suggested in the Instructions for Use for each fall-arrest device.

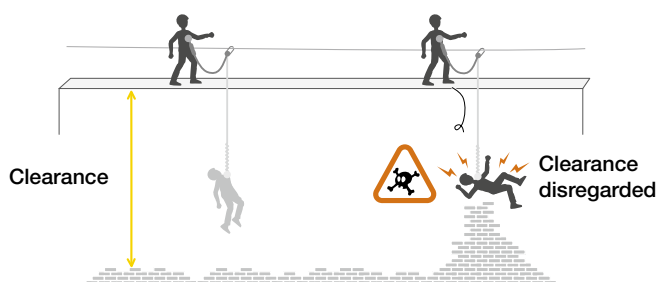

To learn more about calculating clearance, see the technical information available at Petzl.com

PETZL.COM

Anticipating the Means of Rapid Evacuation

• Limiting the effects of inert suspension:

In the event of a fall where the worker loses consciousness or is incapacitated, inert suspension in the harness presents a mortal danger requiring an urgent response. Work teams must be equipped and trained to quickly evacuate an injured team member.

• Evacuating a victim without assistance:

Procedures for evacuating workers should be determined whenever a new worksite is established.

Releasable systems can be created when installing work ropes to allow evacuation from below.

Working alone must be prohibited: a worker may find themselves alone at height, but at least one person trained in evacuations should be present and equipped on site.

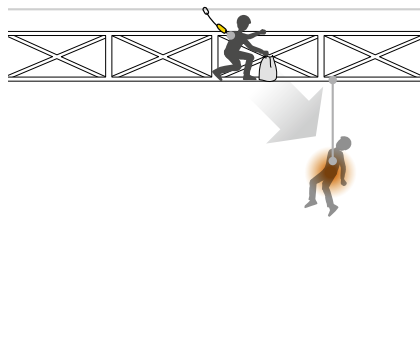

ROPE ACCESS AND CONFINED SPACE



PETZL SOLUTIONS



STRATO® VENT



NEW
2025

ASTRO®



NEW
2025

PODIUM



RIG®



ASAP® LOCK



Bridge inspection, Red Cliff Bridge, Colorado, USA © 2024 - Petzl Distribution - Vuedici.org - Lafouche



ASAP[®] SORBER AXESS



TRANSPORT 30/45/60



Rope Access

Installing Ropes

Load-sharing anchors with the rope.

Bunny knot (for load-sharing anchors).

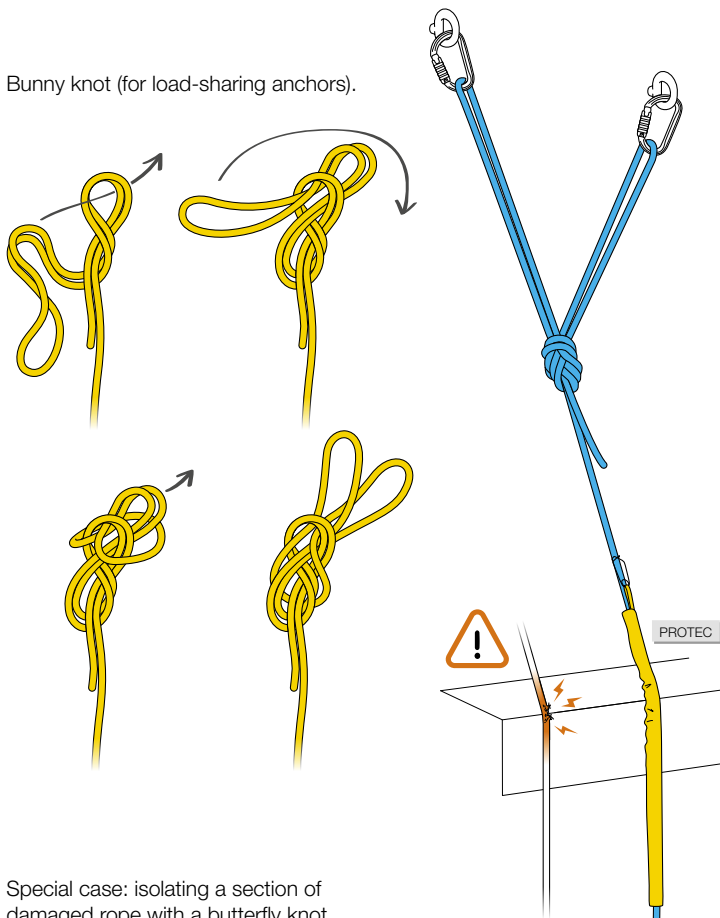

Special case: isolating a section of damaged rope with a butterfly knot.

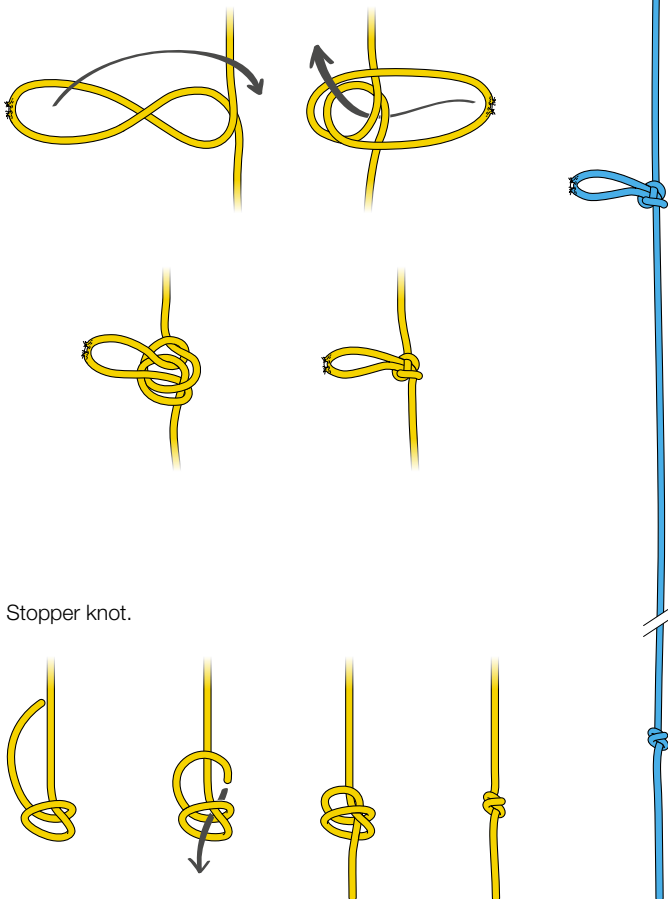

Stopper knot.

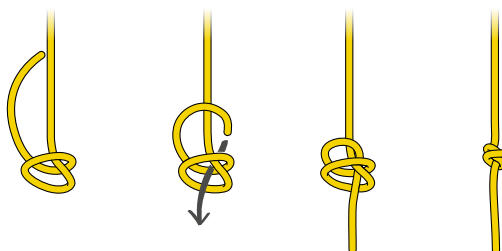

Fixed anchor.

Releasable anchor.

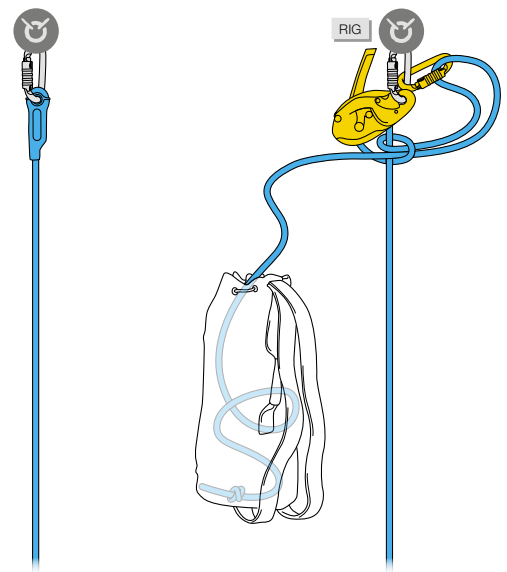

Protecting the Rope

On an angle.

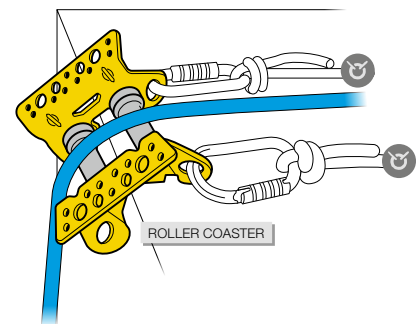

On a flat / hard surface.

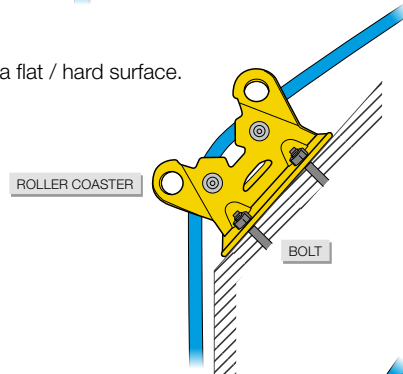

On a soft surface.

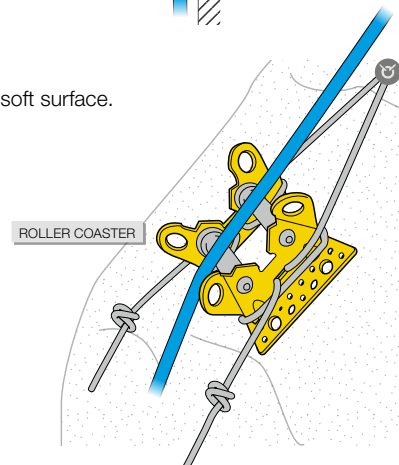

Permanent anchors.

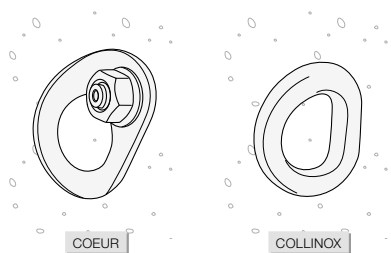

Temporary anchor.

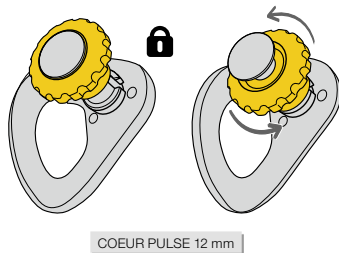

How to install and inspect COEUR PULSE 12 mm anchors

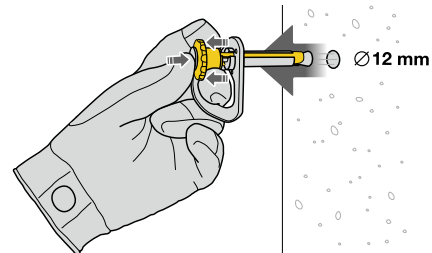

Temporary adjustable anchors.

To wrap around an existing structure by precisely adjusting the length of the anchor.

Large structures.

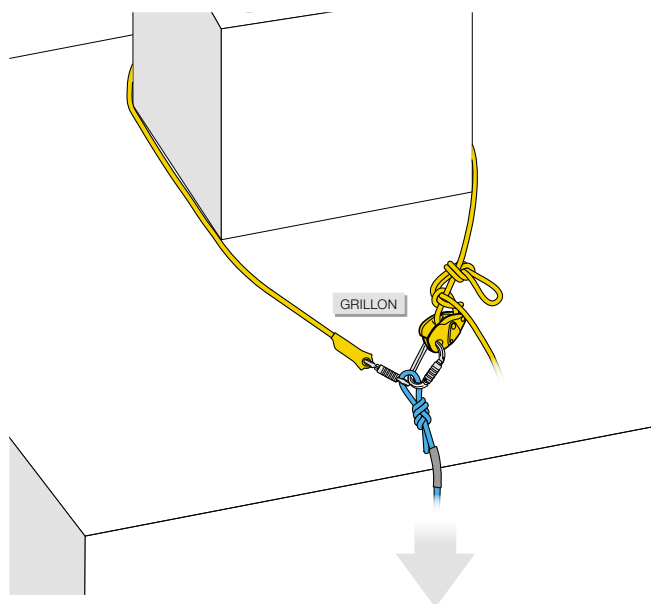

Structures requiring specific positioning.

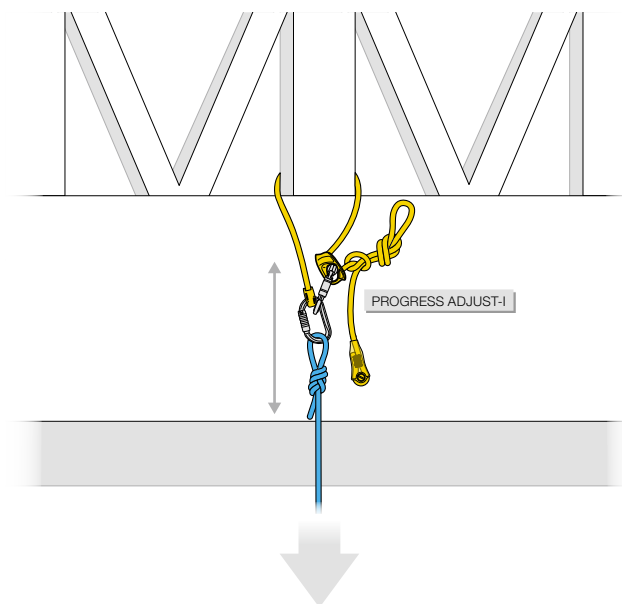

Temporary anchors with multiple configurations.

To best adapt to a situation, whether by connecting directly to the anchor, or connecting to a structure by wrapping around it or using a choker hitch.

CONNEXION VARIO 0.3 - 4 m

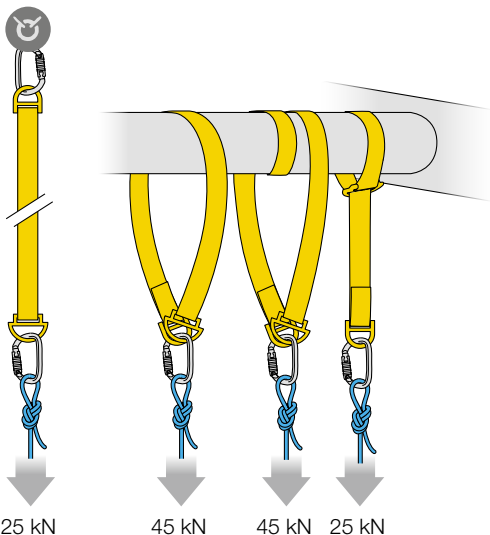

WIRE STROP 0.5 - 3 m

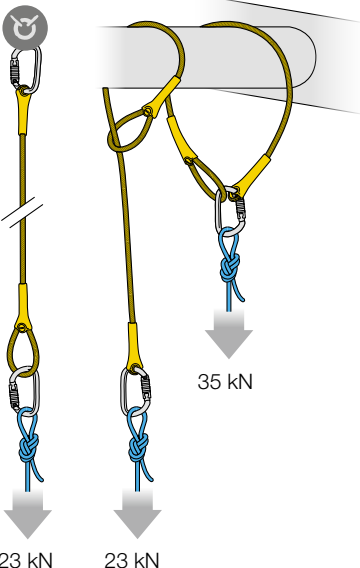

ANNEAU 0.6 - 1.5 m
ST'ANNEAU 0.24 - 1.2 m
PUR'ANNEAU 0.6 - 1.8 m

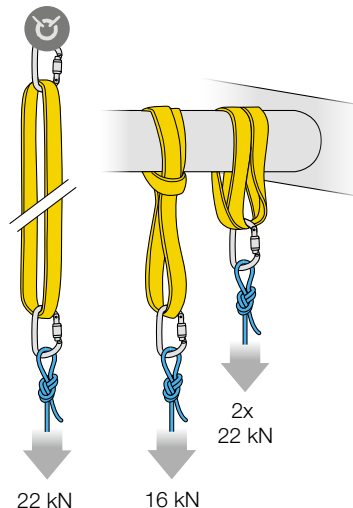

How to use the WIRE STROP

Gated ventral attachment point on ASTRO harnesses

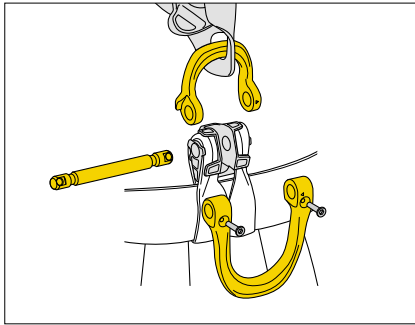

The ventral attachment point on ASTRO harnesses is gated for optimal integration of equipment.

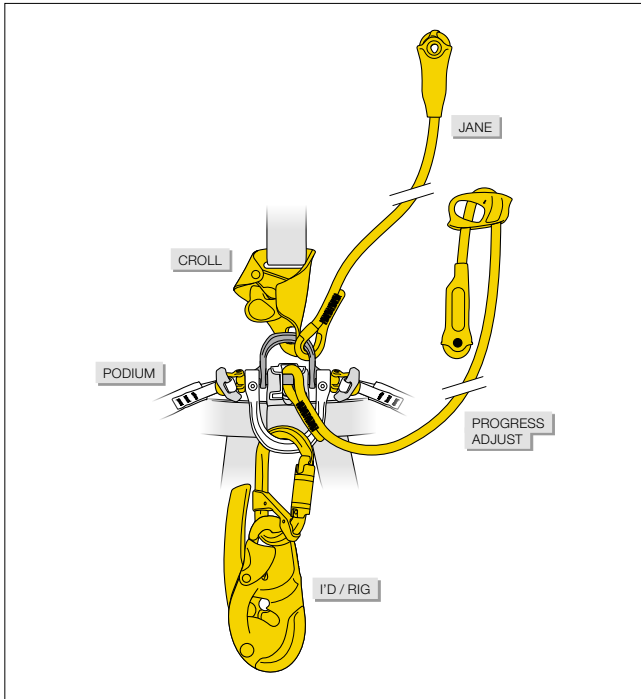

The CROLL ventral rope clamp connects to the small metal D ring for greater efficiency on rope ascents.

The RIG descender attaches to the large metal D ring.

The PODIUM work seat connects to the pin with shackles, allowing a direct connection to the descender while preserving ventral attachment point mobility.

The PROGRESS ADJUST lanyard connects directly to the pin, eliminating the need for a connector.

A second lanyard (the JANE for example) can be connected to the small D ring next to the CROLL.

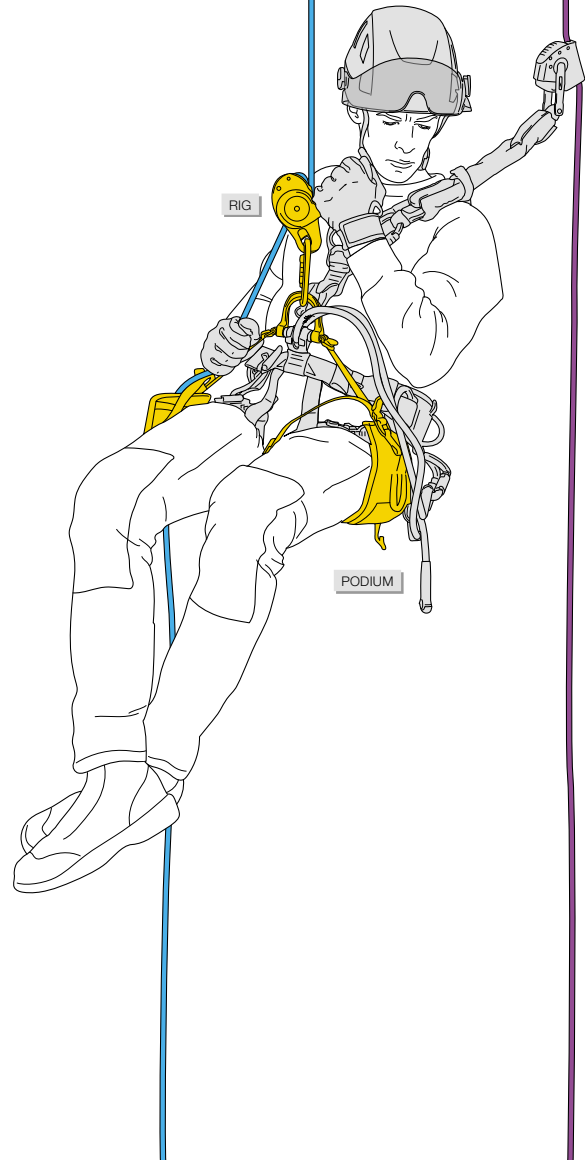

PODIUM and LITEPOD Work Seats

The PODIUM and LITEPOD work seats offer multiple harness connection options depending on the harness attachment point.

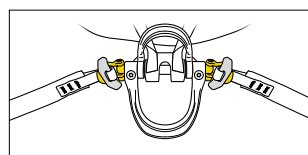
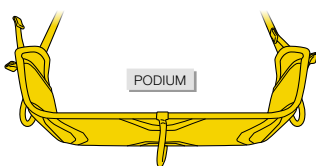

On the gated ventral attachment point with shackles.

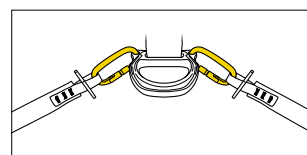

With the MINO.

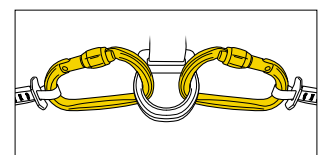

With a carabiner.

1. Combined lowering/raising system

- Advantage: quick transitions between modes (lowering/raising)
- Disadvantage: rope length is four times the travel distance



How to use the TWIN RELEASE

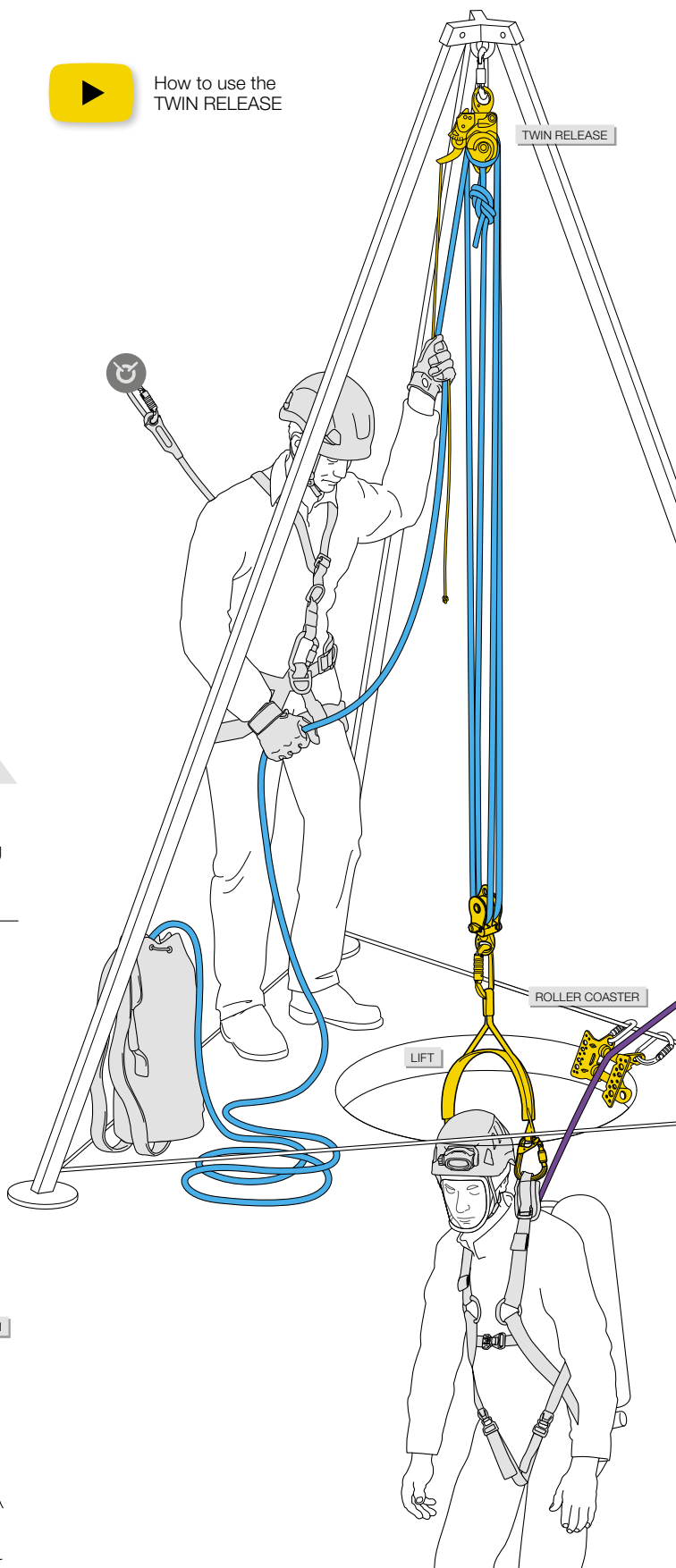
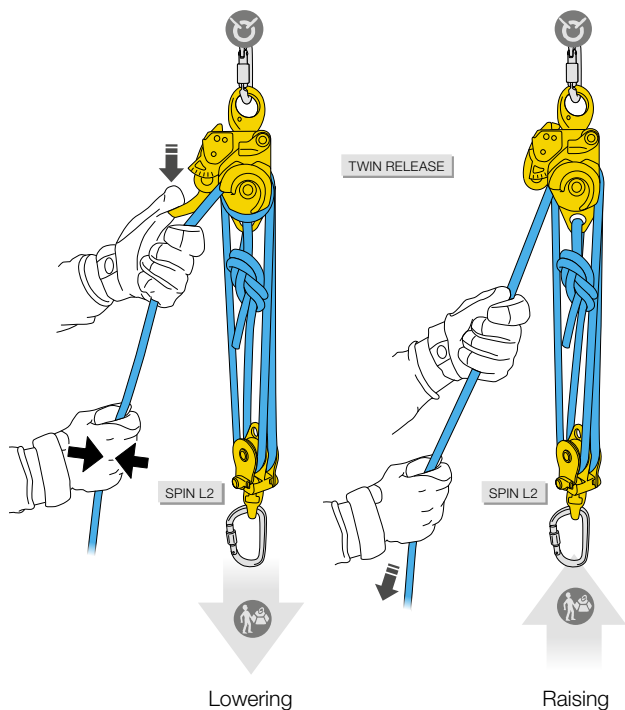

2. Independent lowering/raising systems

- Advantage: the length of the rope equals the travel distance
- Disadvantage: rigging is required to transition between lowering and raising

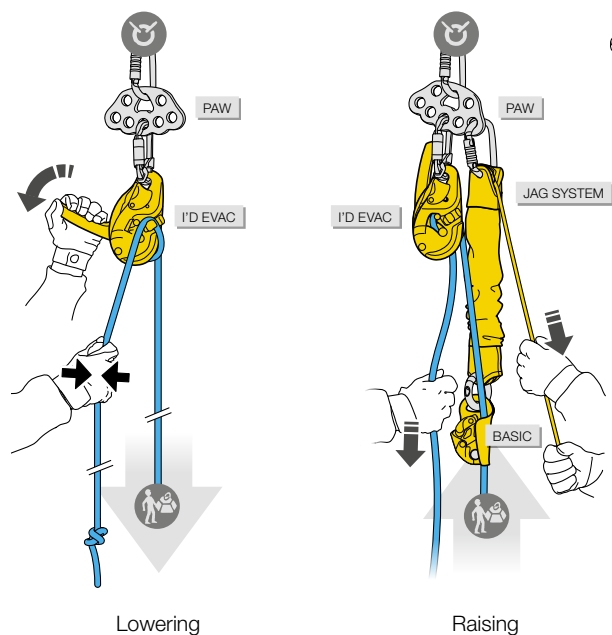

i+ For more information: see the technical tips at Petzl.com

PETZL.COM

TREE CARE



PETZL SOLUTIONS



STRATO® VENT
+ VIZEN MESH
+ Nape protector



SEQUOIA®



ZIGZAG® PLUS



NAJA

NEW
2025



FLOW 11.8 mm



TRANSPORT 30/45

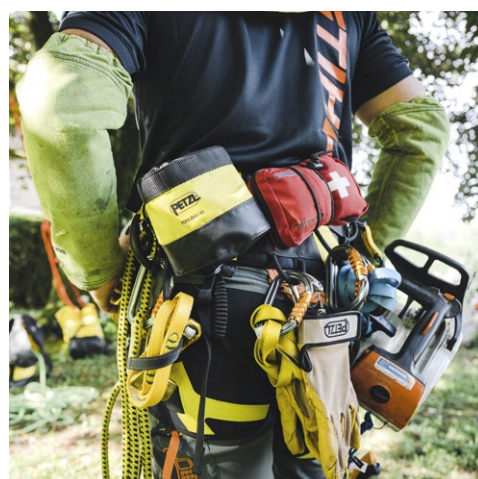

Tree Access

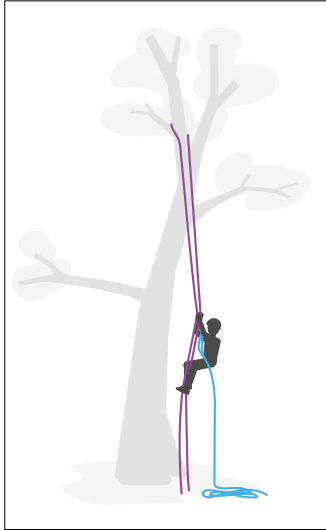

Doubled rope ascent technique

The arborist ascends the access rope (purple). In the event of a problem, such as a hornet attack, they can self-evacuate with the work rope (blue). A mule knot or releasable knot secures the ZIGZAG.

This versatile ascent technique is adaptable to many situations and allows an access rope to be available during work.

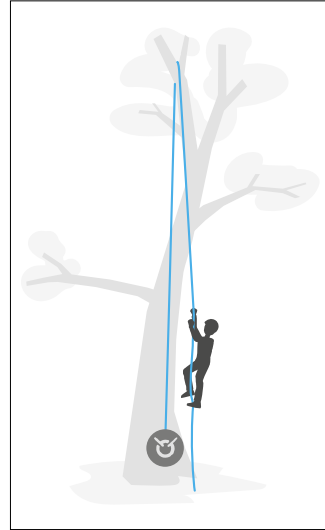

Single rope ascent technique

The access rope is attached to the base of the tree and runs through an appropriate anchor in the tree. It will also be used for work. On a single rope, the ZIGZAG must only be used with the CHICANE.

This technique allows for rapid rescue and efficient climbing with the KNEE ASCENT knee ascender.

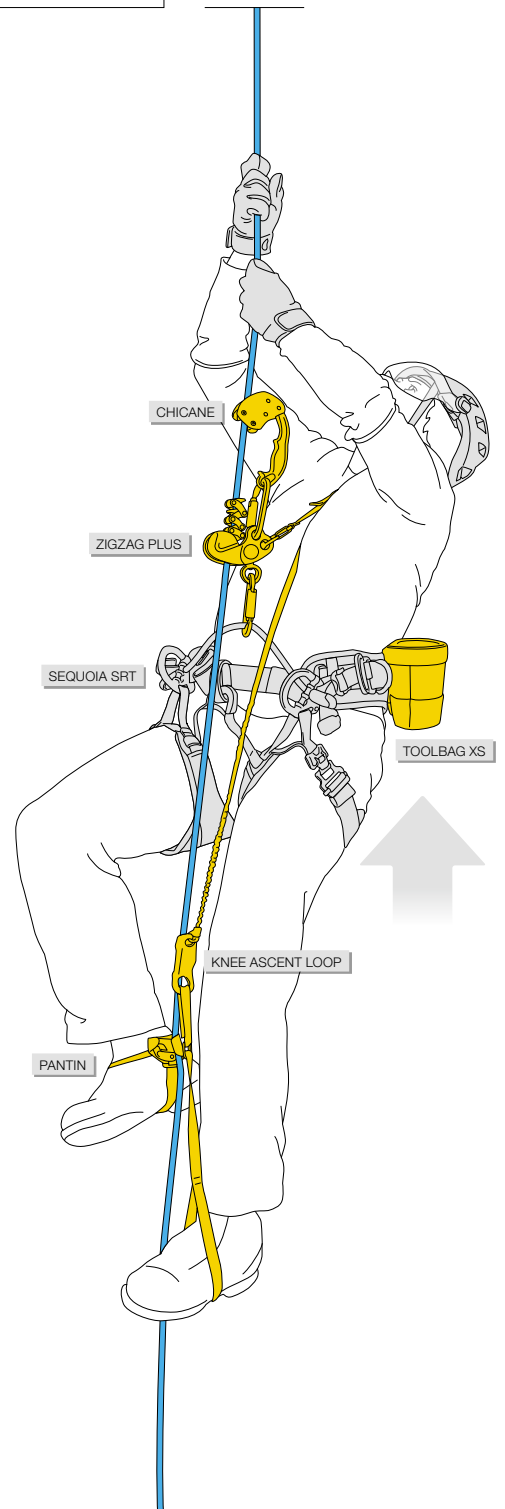
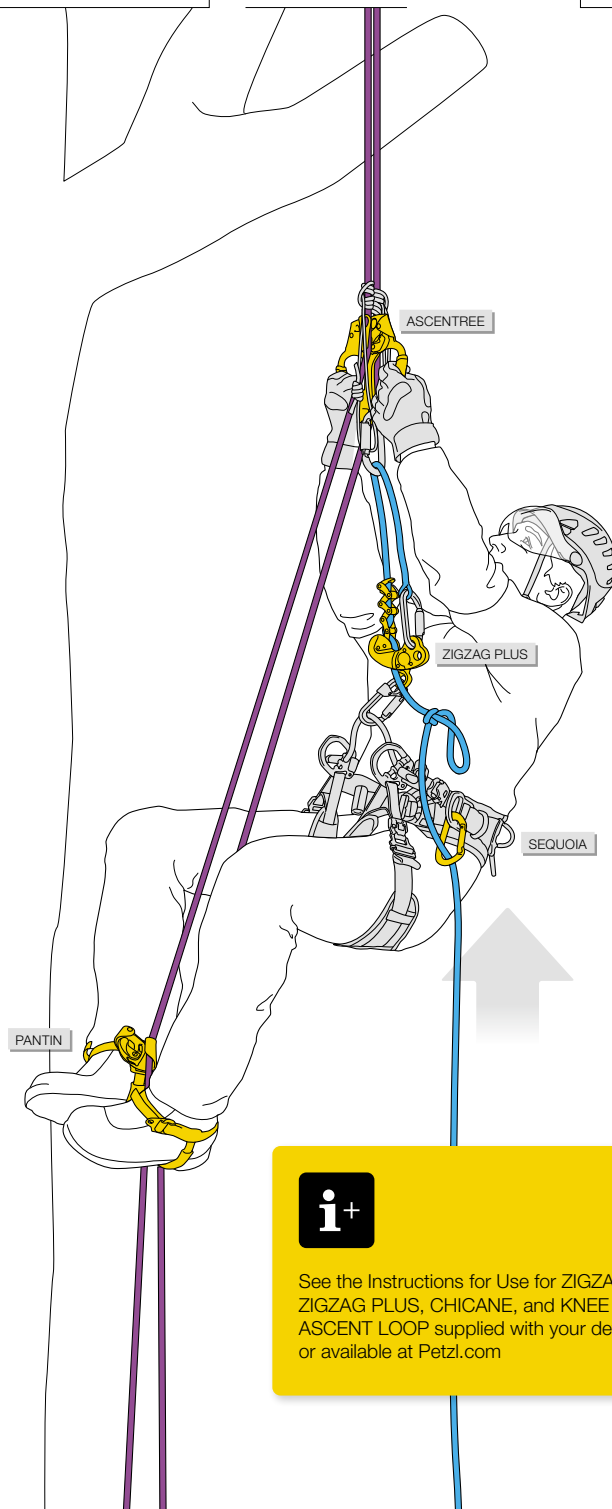

See the Instructions for Use for ZIGZAG, ZIGZAG PLUS, CHICANE, and KNEE ASCENT LOOP supplied with your devices, or available at Petzl.com

PETZL.COM

Movement Within the Tree

Moving within the tree with two anchors

Using two systems simultaneously on two separate anchors provides optimal balance while cutting and facilitates movement.

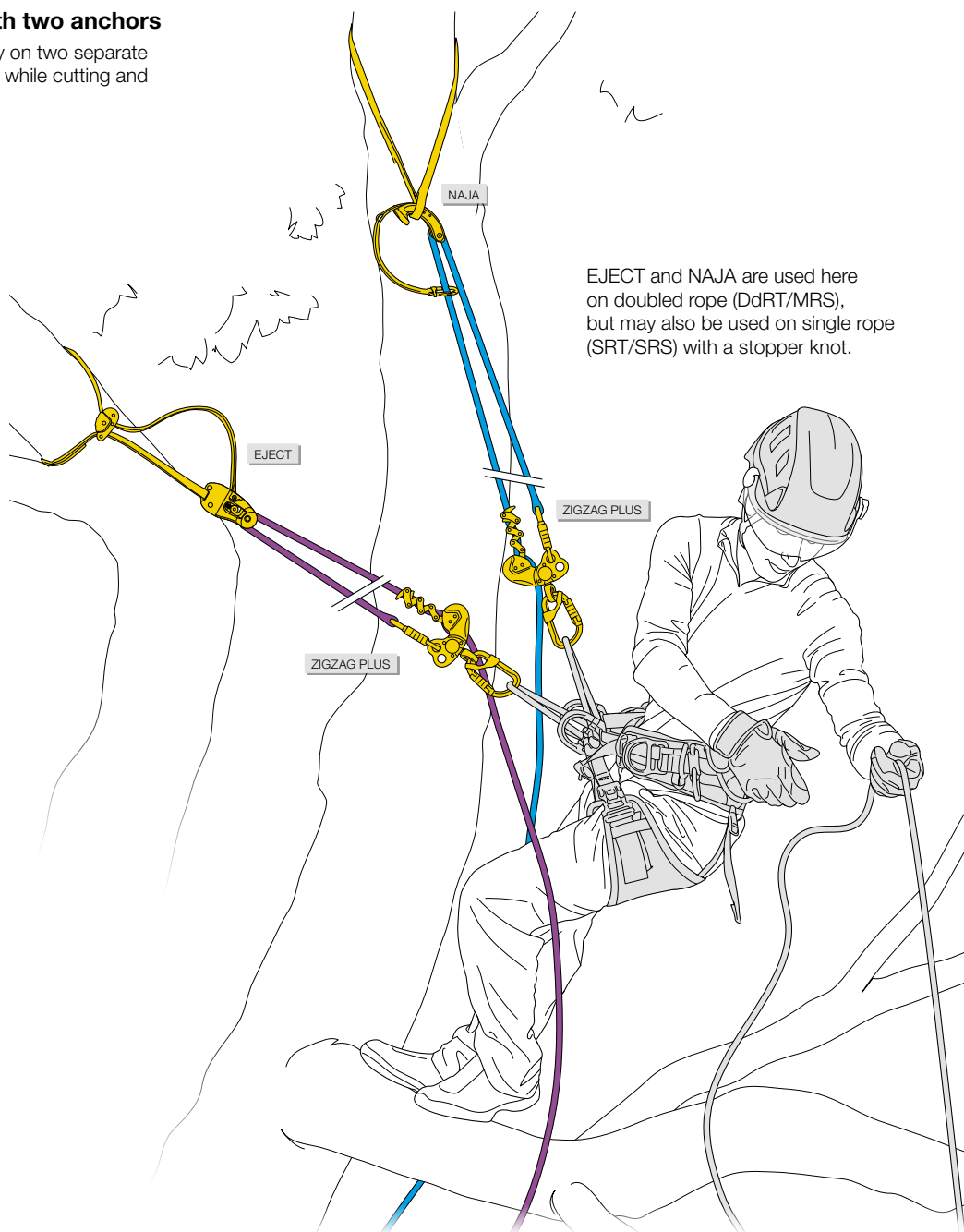

How to install and retrieve the EJECT friction saver using a doubled rope system



How to Use NAJA on a Single Rope (SRS)



How to Use NAJA on a Doubled Rope (MRS)

EJECT and NAJA can be used on a single rope (SRT/SRS) with a stopper knot.

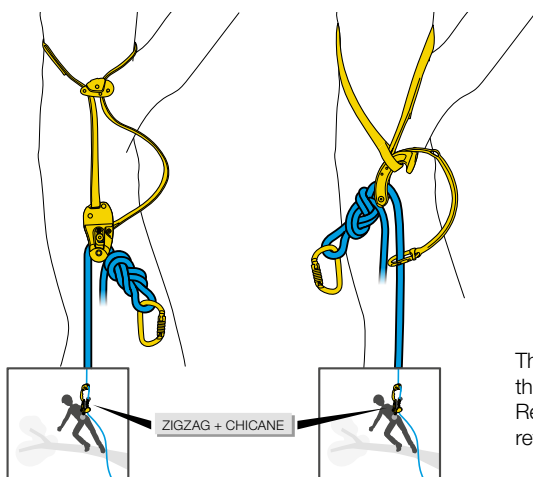

The knot can be placed to the left or right of the pulley. Reference installation and retrieval details at Petzl.com



To learn more about access and progression techniques, see the technical information available at Petzl.com

ENERGY AND NETWORKS



PETZL SOLUTIONS



VERTEX®-VENT



VOLT®

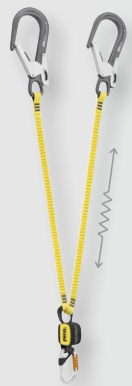

ABSORBICA®-Y MGO 150



GRILLON HOOK



INTERFAST



TOOLEASH



TOOLINK



TOOLBAG

NEW
2025



PIXAR® R

Protected ascent using a double lanyard with integrated energy absorber

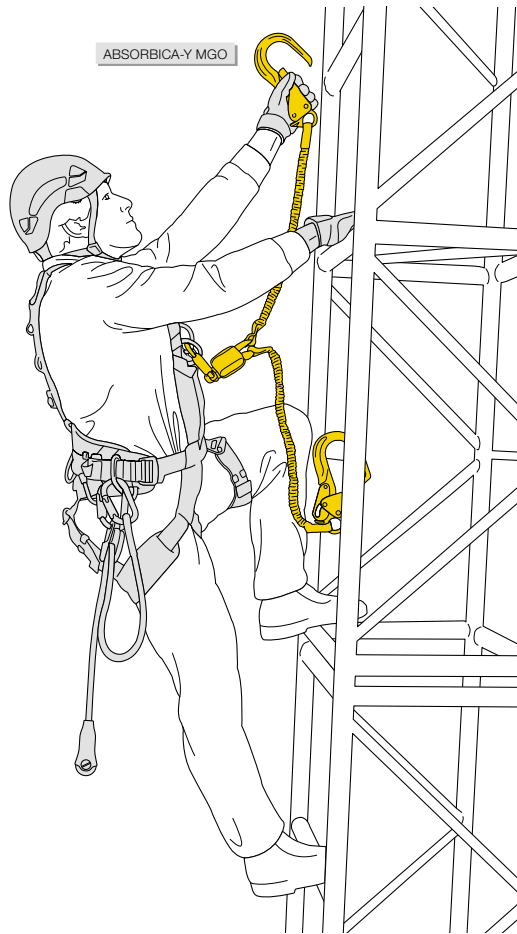

Work positioning with GRILLON lanyard used in double mode



i+

To calculate your clearance value with an ABSORBICA lanyard, see our clearance calculator at [Petzl.com](https://www.petzl.com)

PETZL.COM

Dropped object prevention solution

All products in this range allow you to adapt your setup based on the weight and type of tools that need to be tethered.

Examples of possible combinations:

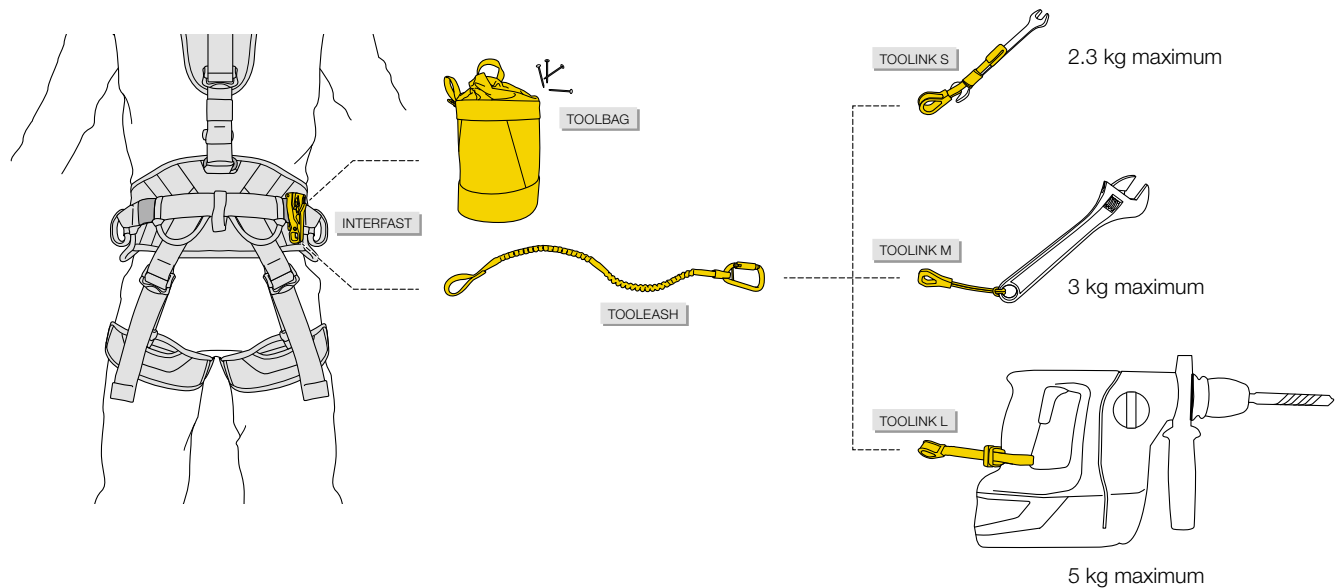

Reduce Fall Distance

The longer the free fall, the greater the absorber deployment will be. The required minimum clearance (distance between the user and an obstacle), should therefore be greater than those values combined.

User weight, lanyard length, and position in relation to the anchor can affect these values.

It's possible to reduce fall distance before leaving the ground or once you've already started working at height.

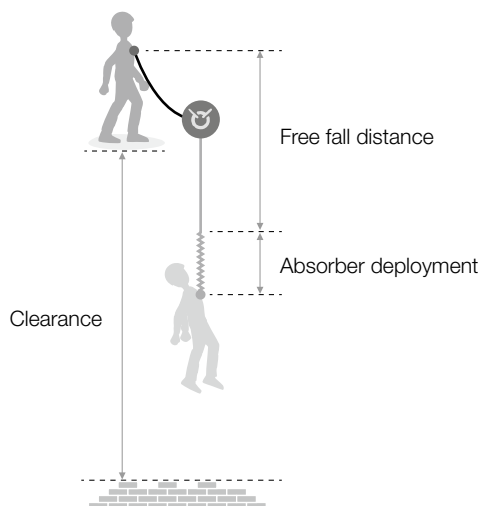

- **Before leaving the ground: choose your fall-arrest system**

The total length of the system determines maximum free fall distance.

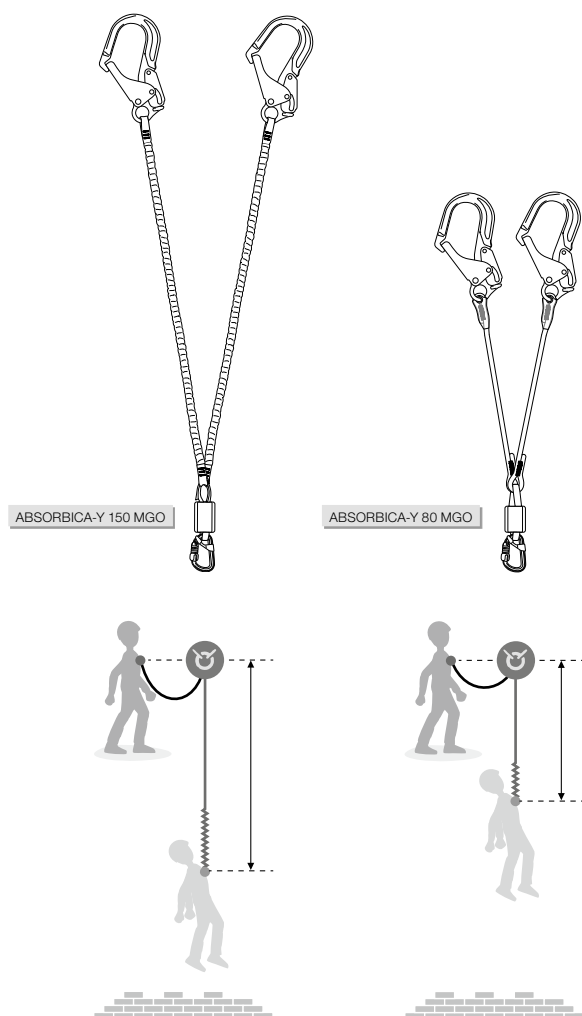

- **While at height: choose your anchor**

The simplest way to reduce fall distance is to use the highest anchor possible in relation to your work position.

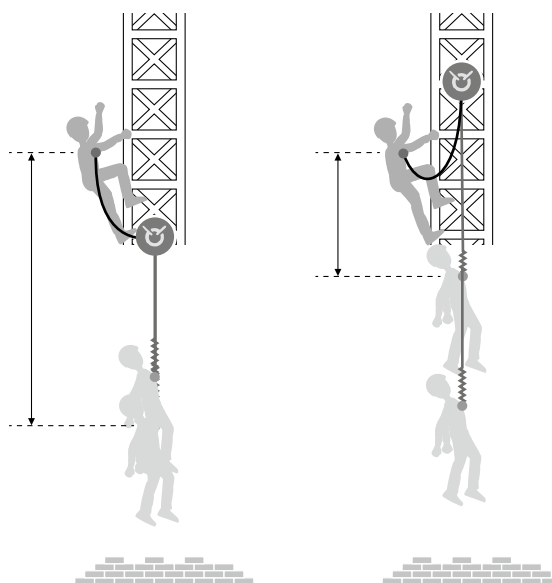

Using an adjustable lanyard allows you to adjust the length of your fall-arrest system and therefore reduce fall distance while adapting to work situations.



FRAMING AND ROOFING



PETZL SOLUTIONS



VERTEX® VENT



NEWTON EASYFIT



ASAP®



ASAP®SORBER



ASAP®AXIS 11 mm

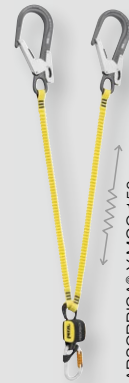

ABSORBICA®-Y MGO 150



TOOLEASH



TOOLINK



TOOLINK

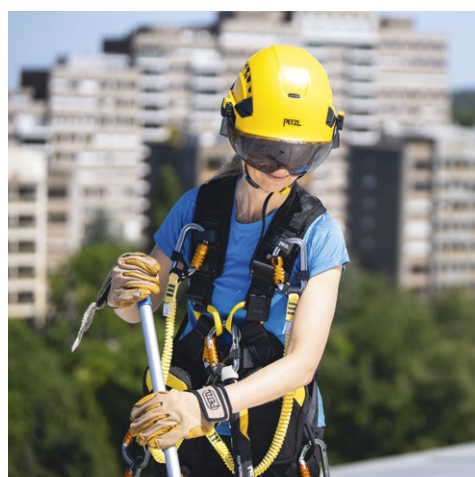

Framing and Roofing

1. Roof access

Installing a rope with releasable anchor; backed up ascent with the ASAP.

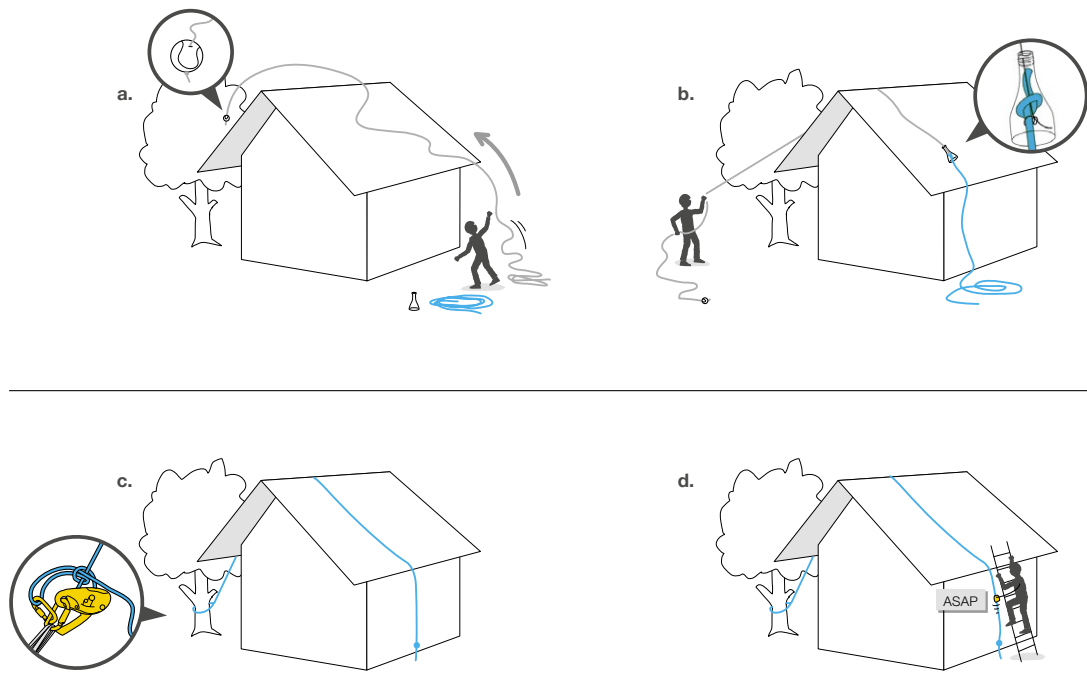

2. Long-term use

With individual positioning system and collective protection.

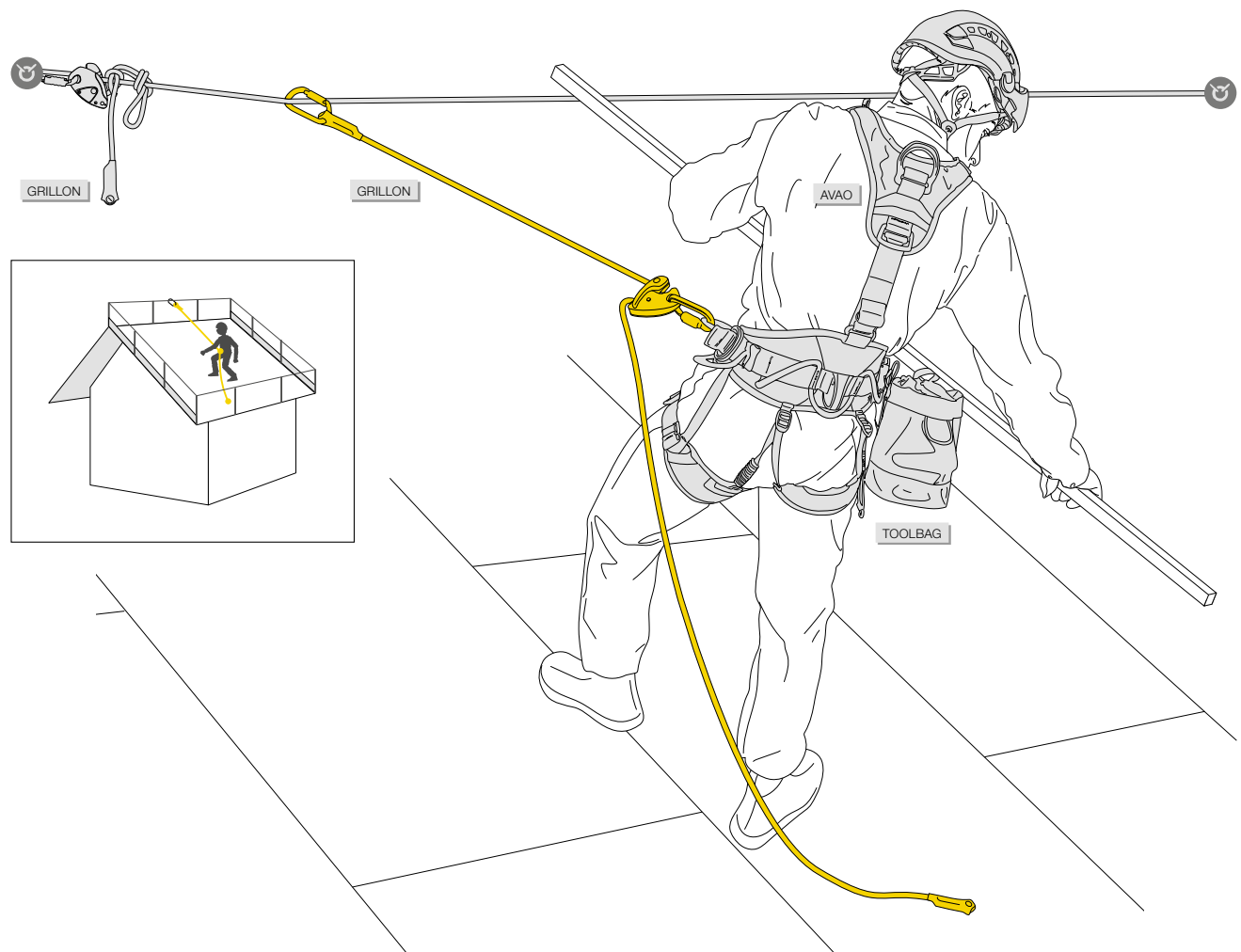

3. Occasional use

With individual fall-arrest system.

- Working in the center of the roof (limited access zone)

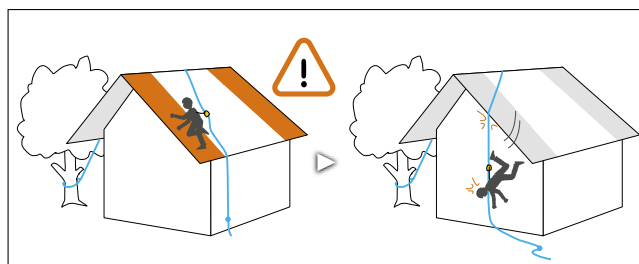
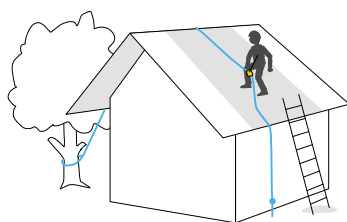

- Working at the edges

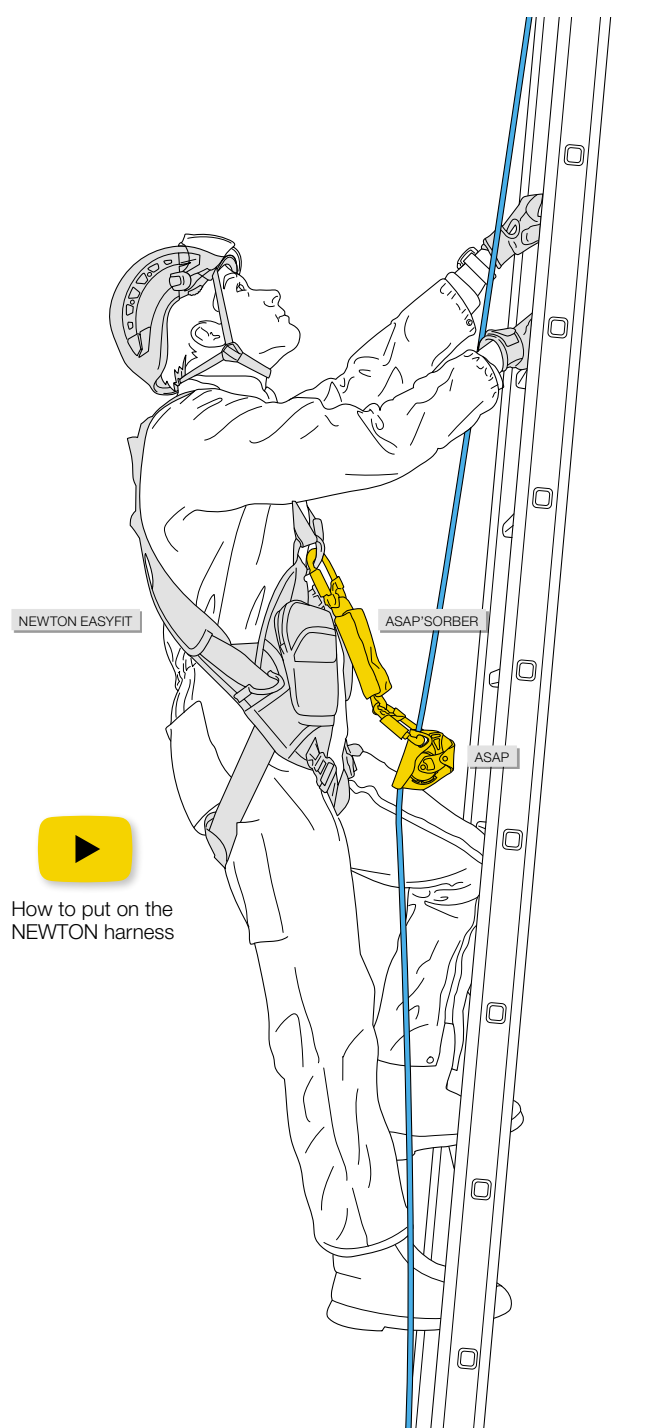
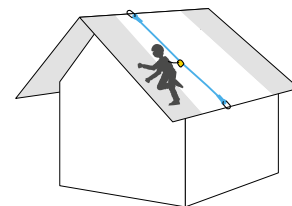

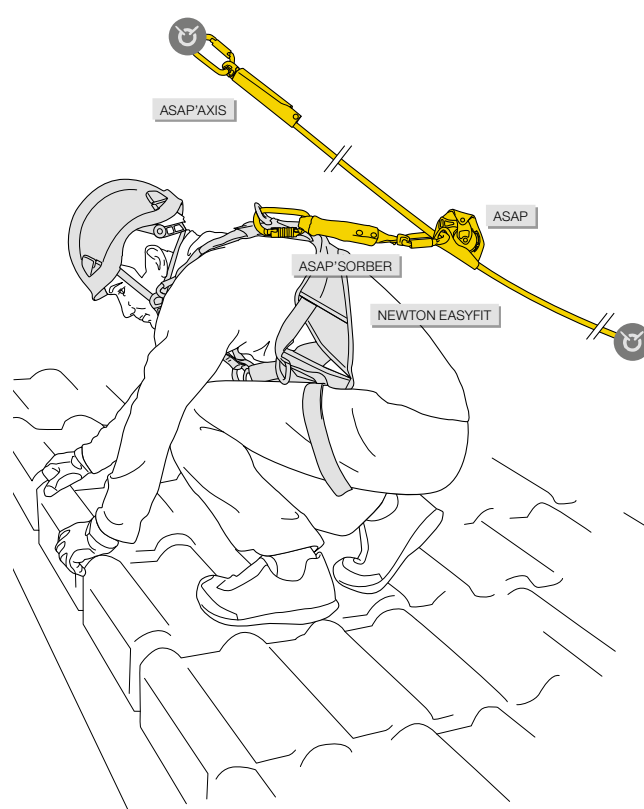

How to put on the NEWTON harness



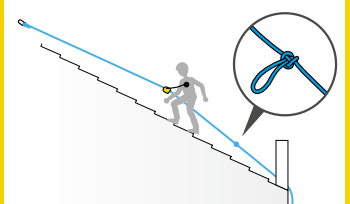

For more information: see the technical tips at [Petzl.com](https://www.petzl.com)

GENERAL RESCUE PRINCIPLES

Inert suspension in a harness, even for a short time, can cause serious physiological harm. In the event of an accident, it is important to respond quickly with the appropriate technique.

Self-Rescue

On sites where the main access could be cut off by fire, people must be ready to quickly evacuate the building. They have evacuation kits. These kits are either portable or installed permanently on the structure. When there is no existing anchor, a hook-based system can be used. In both cases, teams must be regularly trained so they don't panic in the event of a fire.

On-Site Rescue

When a worksite is being set up, the company must establish a risk prevention plan (inventory of risk situations):

1. It must protect the personnel from falls from height. The solutions chosen, whether collective or individual, must protect the team members while they work.
2. In the event of an incident, the company must be prepared with rescue systems for accessing, releasing, and evacuating the victim.

These solutions are established with:

- Ready-to-use rescue kits, adaptable to many situations and simple to use
- Personal equipment for the worker at height (solution requiring experienced and well-trained teams)

In both cases, the teams undergo regular training, so they can respond quickly in the event of an accident.

Technical Rescue

Technical rescue teams must be able to respond quickly in any situation. They must choose the quickest, most effective way to access the victim.

- When access is easy or possible by motorized means, they can easily transport the rescue equipment
- In more difficult access situations, they may use rope access techniques from above or below, and their equipment will be lightweight and versatile
- Finally, a helicopter can be used when victim access is complicated and/or remote, for example in the mountains

Cable Lift Evacuation

Cable lift evacuation operations follow an evacuation plan. Rescue kits are put together to meet the specific needs of each operator.

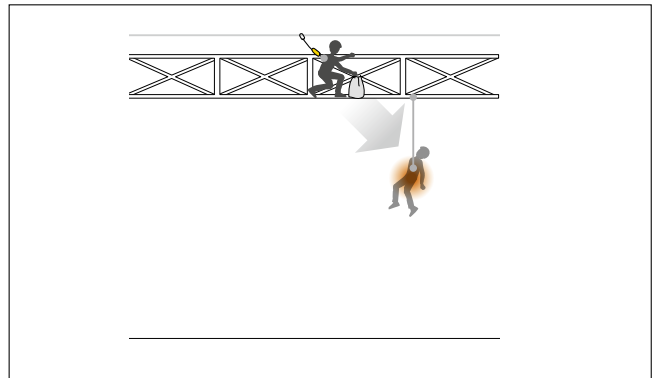

1. Accessing the victim

Accessing the victim can sometimes be complicated. Rope access techniques are used in these cases. When access is possible from above, rescuers use rope descent techniques. If an access rope is in place, rescuers can ascend the rope using handled and ventral rope clamp techniques. In other situations, rescuers are obliged to use climbing techniques to reach the victim.

Example of access from above

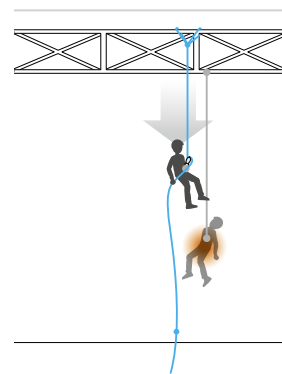

Example of access from below

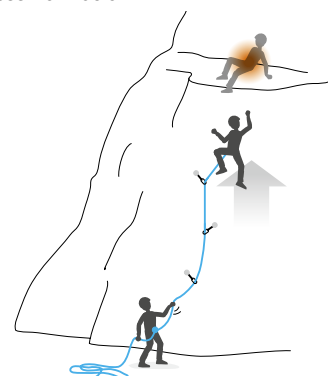

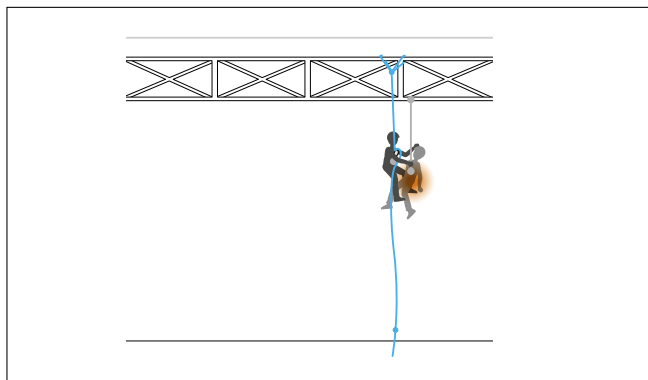

2. Releasing the victim

Raising

This involves using a mechanical advantage pulley system in order to easily raise the victim. A rescuer working alone uses a mechanical advantage system to reduce effort. The disadvantage is that a long rope is required. If there are enough rescuers, a lower mechanical advantage is used to speed up the operation.

Counterbalance technique

This is a counterweight system. The rescuer is on one side, the victim on the other. The rescuer unweights the rope on the victim's side by pulling upward. The victim ascends and the rescuer descends. The advantage of this system is that it is easy to do with little equipment. Engaging the counterweight is the step that demands the most energy. After that, it is important to be careful to keep the system under control. Beware when there is a significant weight difference between the rescuer and the victim.

Progress-capture pulley for hauling

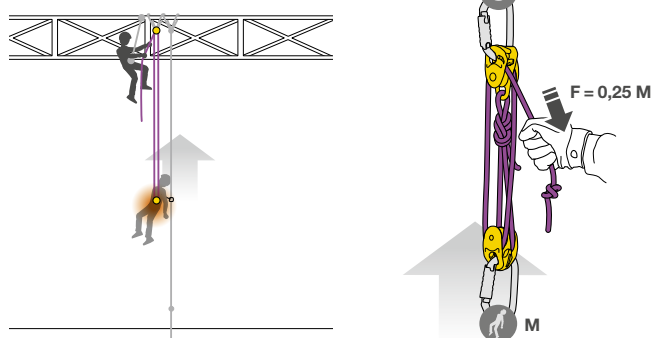

Example of counterbalance

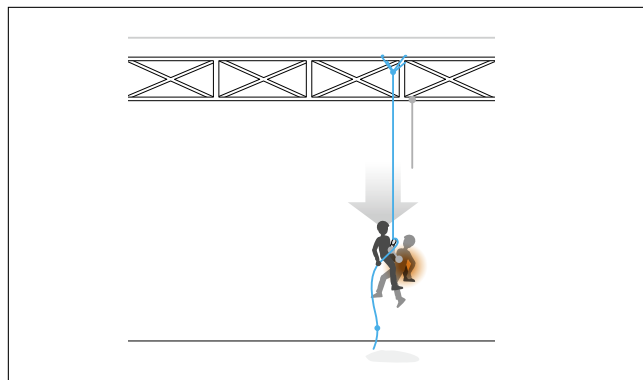
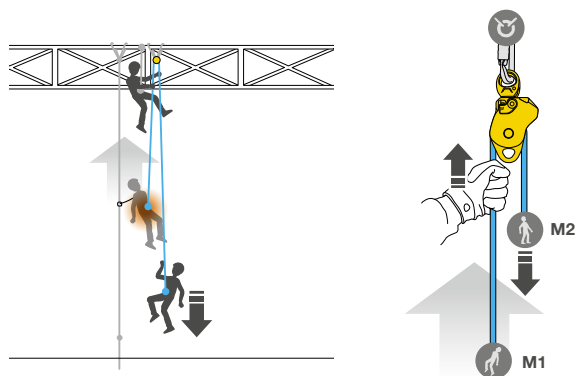

3. Evacuating the victim

Downward, the evacuation is done with a descender. This is the easiest technique currently in use. When downward evacuation is impossible, the victim is evacuated upward or horizontally. Upward, rescuers use either a counterweight or hauling technique. Horizontally, one or more ropes are tensioned. One rope is used for the carriage, another is used as a backup belay, and another to move the litter.

Downward

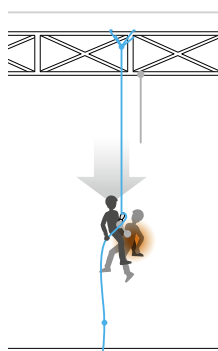

Upward

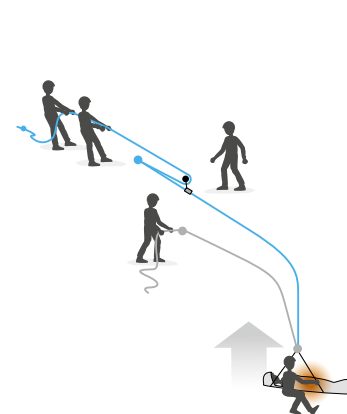

Horizontally

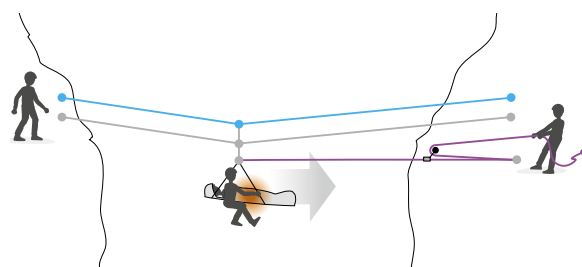

SELF-RESCUE



Firefighter training, United States © 2019 - Petzl Distribution - ROH - SLC FIRE DPT



EXO® AP HOOK

EXO AP HOOK is a personal escape system with an anchor hook, designed for situations where the possibility of finding an anchor point is uncertain. It has a self-braking system with anti-panic function for quickly moving horizontally, climbing through a window, and controlling or stopping a descent. If the user pulls too hard on the handle, the anti-panic function brakes and stops the descent automatically.

Rapid horizontal movement

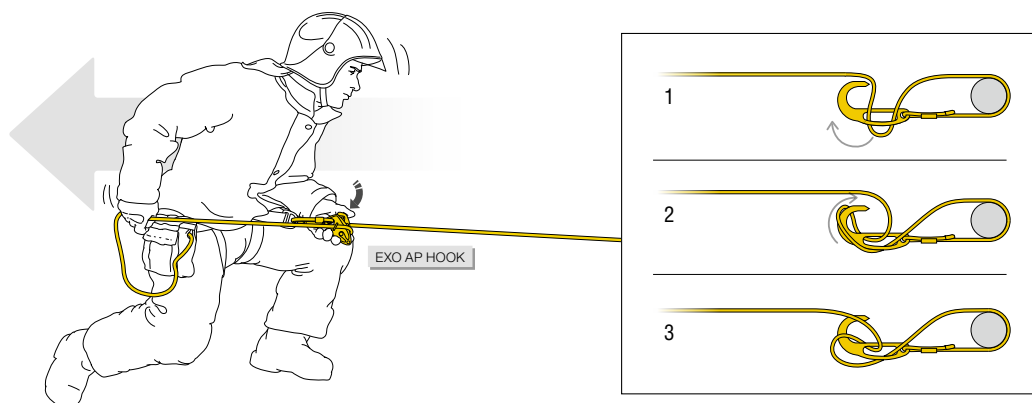

Going through a window while maintaining the anchor hook on the window sill. Locking the left leg against the interior wall to control the movement.

Re-establishment below the window while holding the free end of the rope.

Descending, one hand uses the handle to start the descent, and the other hand holds the rope to control it.

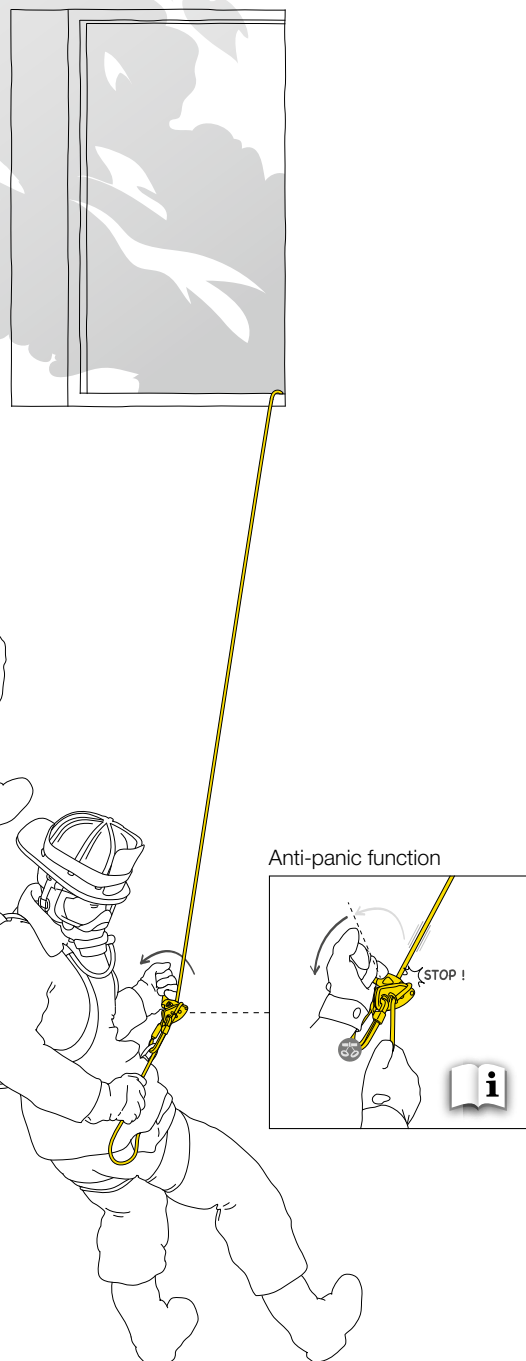
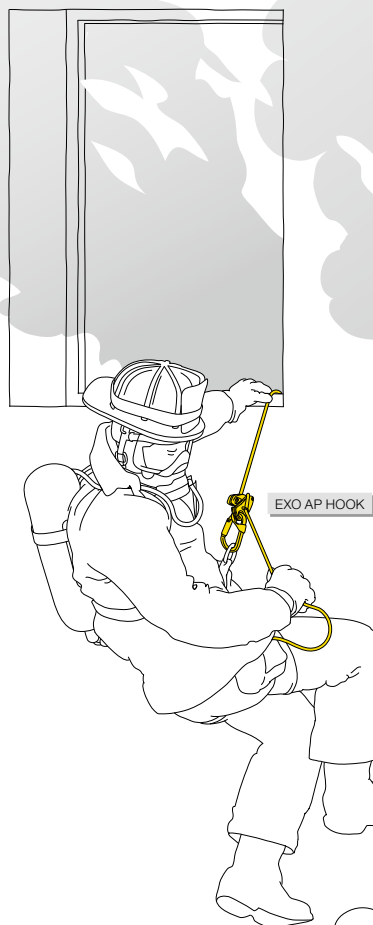

ON-SITE RESCUE





PETZL SOLUTIONS



VERTEX®



VOLT®

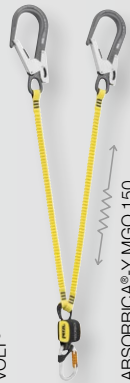

ABSORBICA®-Y MGO 150



JAG RESCUE KIT



XENA®

On-Site Rescue

Release and evacuation of a victim on a CROLL

Rescue from below by a team member with their own equipment. The rescuer must carry out a risk assessment before responding and verify (among other things) that the victim's ropes are in good condition. The counterbalance system is used to transfer the victim onto the descender.

The rescuer ascends on the victim's safety line.

1. The rescuer transfers themselves to the RIG descender, tethers to the victim, and moves the ASAP up above the victim.
2. The rescuer puts a second connection in place. They can then remove the equipment that is in the victim's way.

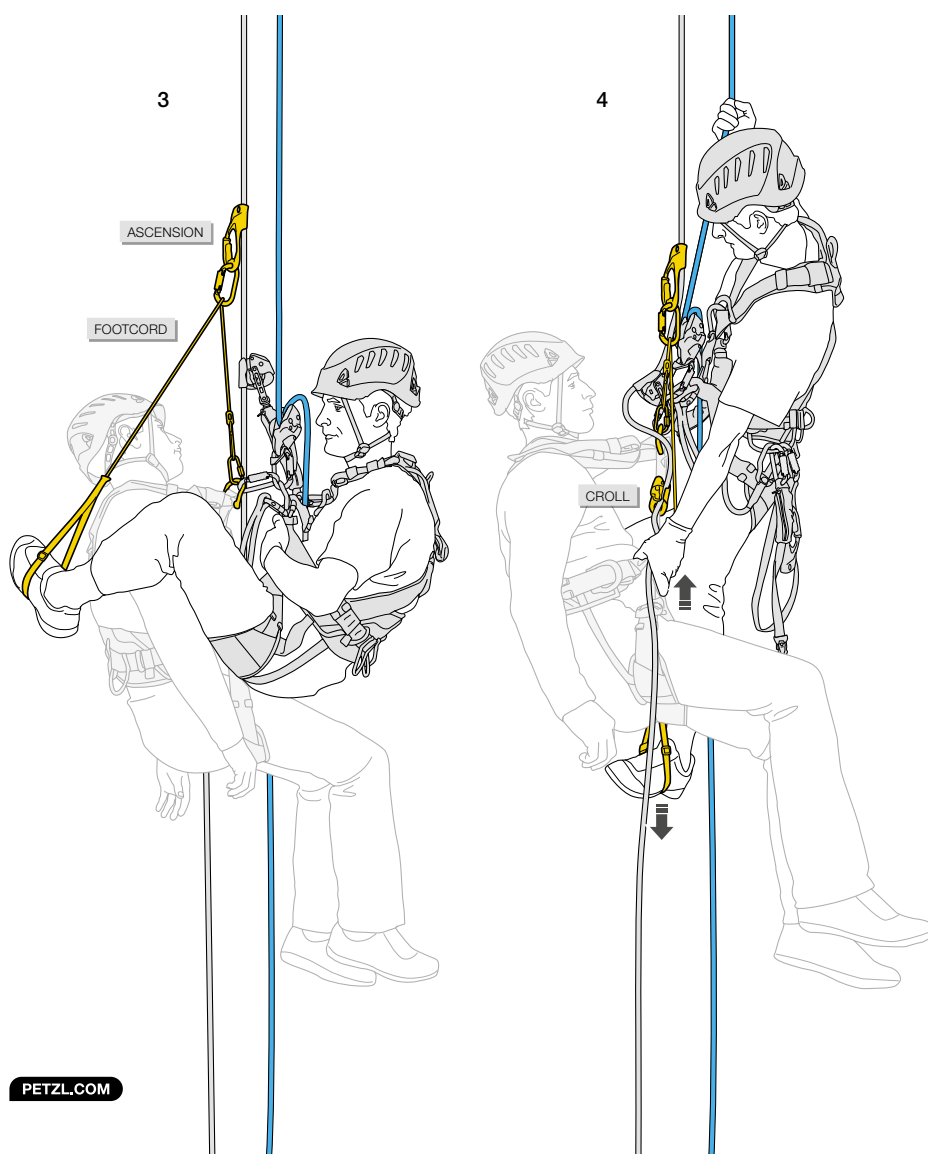
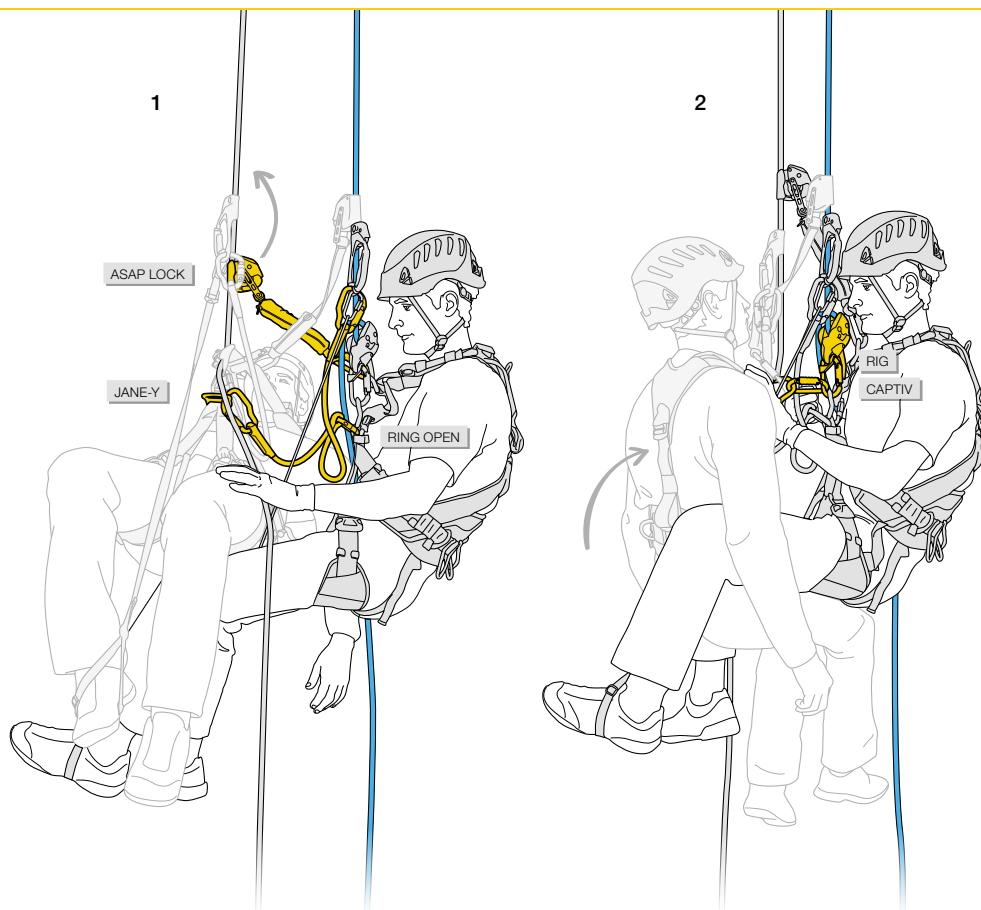

3. On the victim's rope, the rescuer installs a foot loop in counterbalance on the ASCENSION handled rope clamp.

4. In counterbalance on the foot loop, the rescuer prevents the rope from running through the CROLL and raises the victim. They remove the CROLL and take up as much rope slack as possible in the RIG descender.

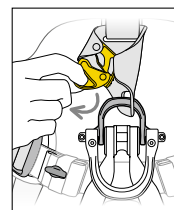

5. The rescuer, hanging on the RIG, removes the handled ascender. They install a braking carabiner and accompany the victim to the ground.

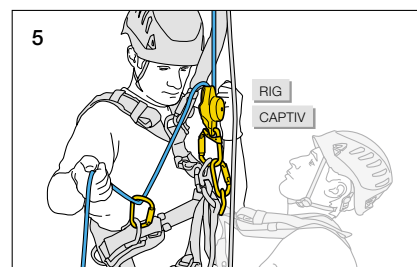

Release and rescue using a reversible rescue kit

- Unaccompanied evacuation (victim doesn't require monitoring or for a free-hanging evacuation):

1. Victim suspended by a lanyard, with the energy absorber torn by the fall.
2. Hauling (allows the victim to be released).
3. Lowering the victim.

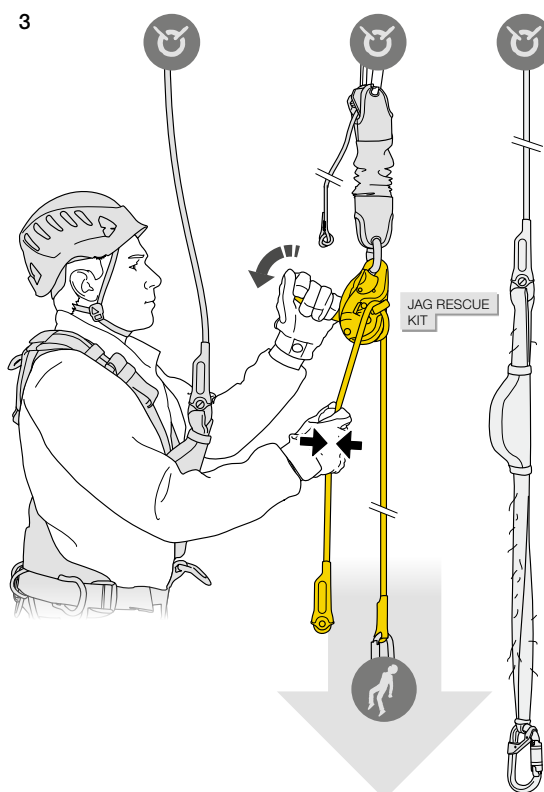
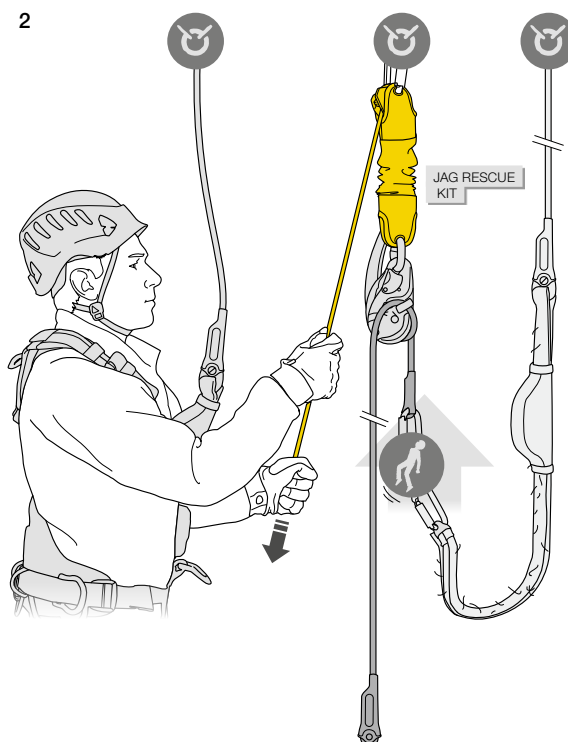
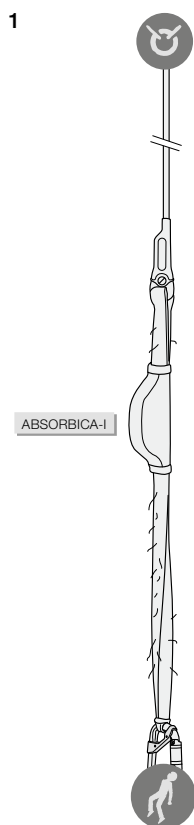

To learn more about using the JAG RESCUE KIT to rescue a victim, see the technical information available at [Petzl.com](https://www.petzl.com)

PETZL.COM



For more information: see the technical tips at [Petzl.com](https://www.petzl.com)

PETZL.COM

TECHNICAL RESCUE



PETZL SOLUTIONS



STRATO® VENT HI-VIZ



FALCON MOUNTAIN



TOP CROLL®



MINI TRAXION



MAESTRO® S



TRANSPORT 45/60



Climber rescue training, Mallos de Riglos, Spain © 2023 Petzl Distribution - Vuedici.org - Lafouche - GREIM - Guardia Civil



XENA®



Using the MAESTRO

The MAESTRO enables controlled lowering of loads up to 250 kg (MAESTRO S) and 280 kg (MAESTRO L).

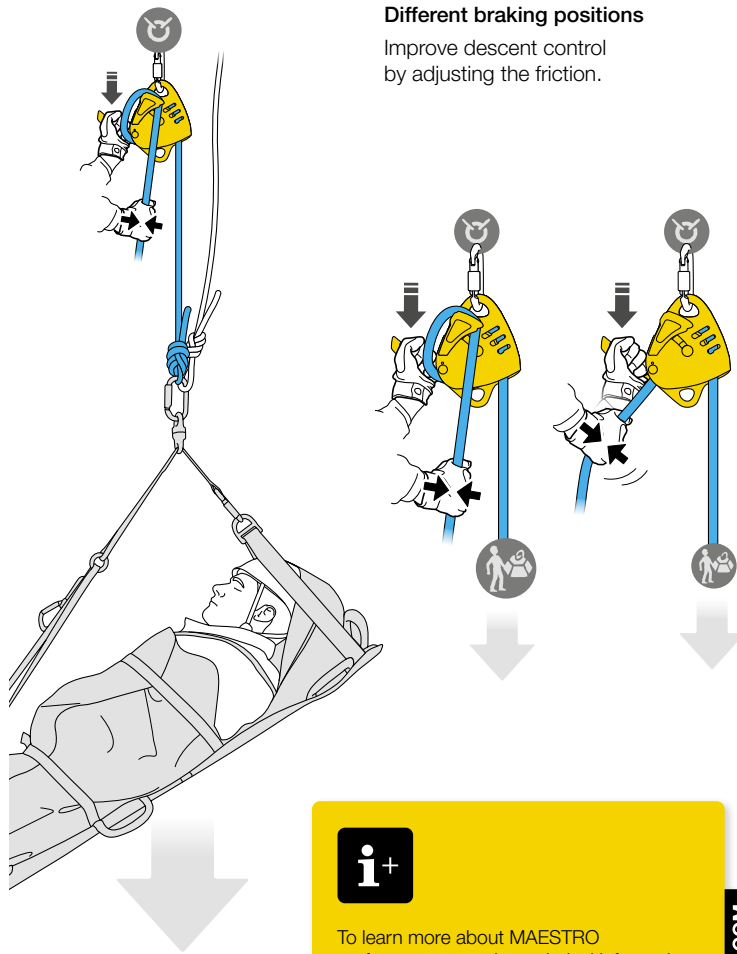

Different braking positions

Improve descent control by adjusting the friction.



To learn more about MAESTRO performance, see the technical information for hauling and lowering at [Petzl.com](https://www.petzl.com)

PETZL.COM

Rope redirect with SPIN L1D pulley

Rope redirect when raising: sheave rotates in the direction of the ascent.

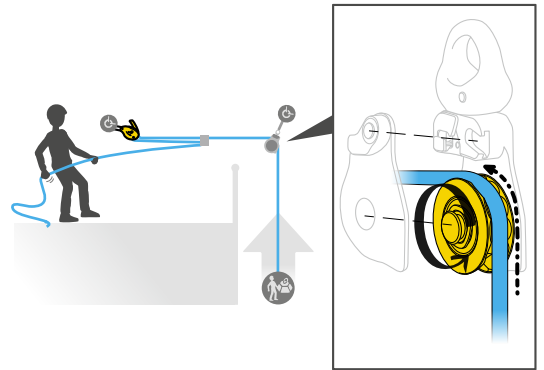

Extra friction makes for a more comfortable descent: the sheave does not rotate, and the facets provide additional friction on the rope.

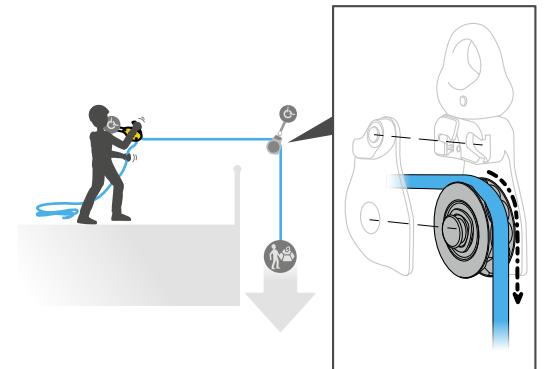

Hauling with MAESTRO or PRO TRAXION

The mechanical advantage of a haul system is a theoretical advantage, but efficiency is affected by several factors in practice, including pulley efficiency, rope diameter, rate of hauling, and regularity of movement.

Here are some test results using a constant rate of 1.5 m/minute. Other results are available in the technical information at [Petzl.com](https://www.petzl.com)

Simple directional (1:1)

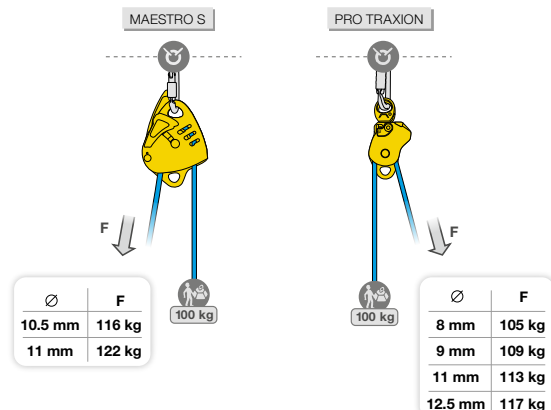

Haul system (3:1)

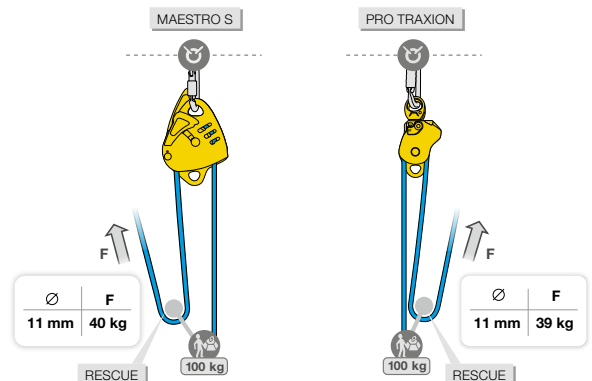

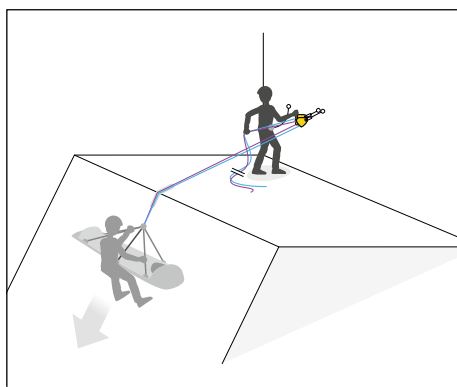

Lowering with two MAESTROs in parallel, controlled by a single operator

One operator simultaneously controls the two devices to optimize load-sharing between the two ropes, while limiting the potential fall distance in case one rope fails.

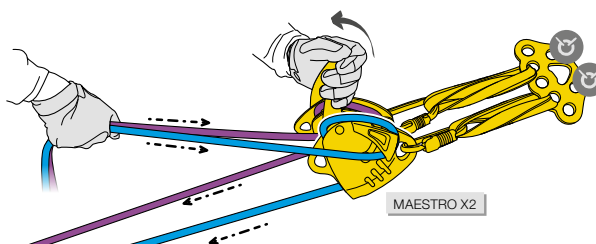

MAESTRO X2



How to belay with the MAESTRO on a backup rope

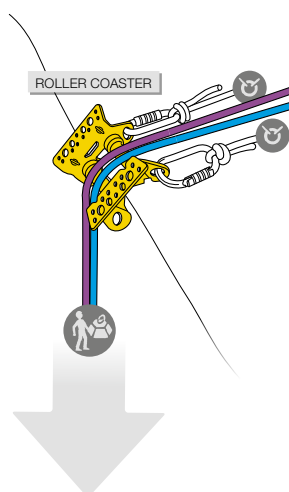

ROLLER COASTER

Addition of a backup system to address potential operator error.

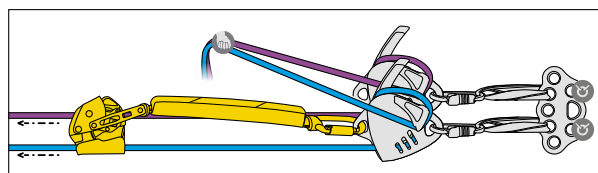

Evacuation on a tensioned highline with REEVE

The REEVE combines two pulleys with a rigging plate for clean and compact rigging of your highline rescue system.

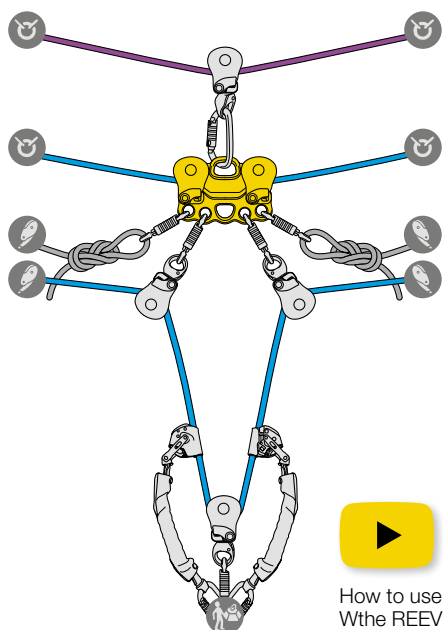

How to use the REEVE

Adjusting position of the litter attendant with JAG SYSTEM

The JAG SYSTEM allows the attendant to efficiently adjust their position, even with all of their weight on the lanyard and without good support for the feet.

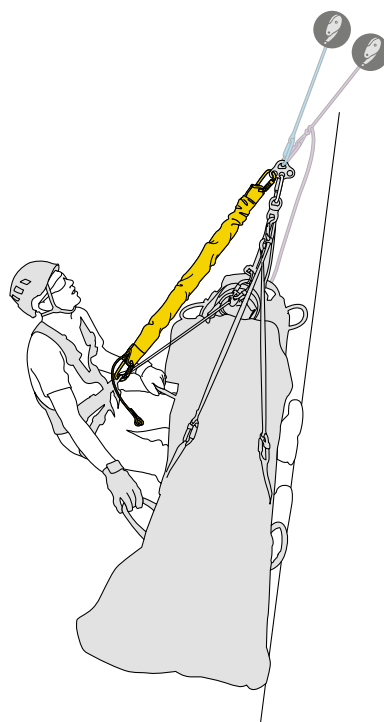

For more information: see the technical tips at Petzl.com

CABLE LIFT EVACUATION



PETZL SOLUTIONS



STRATO® VENT HI-VIZ





NEW
2025

AVAO® FAST



PITAGOR



ID® EVAC



ROLLCAB



GRILLON MGO



SWIFT® RL

Cable Lift Evacuation

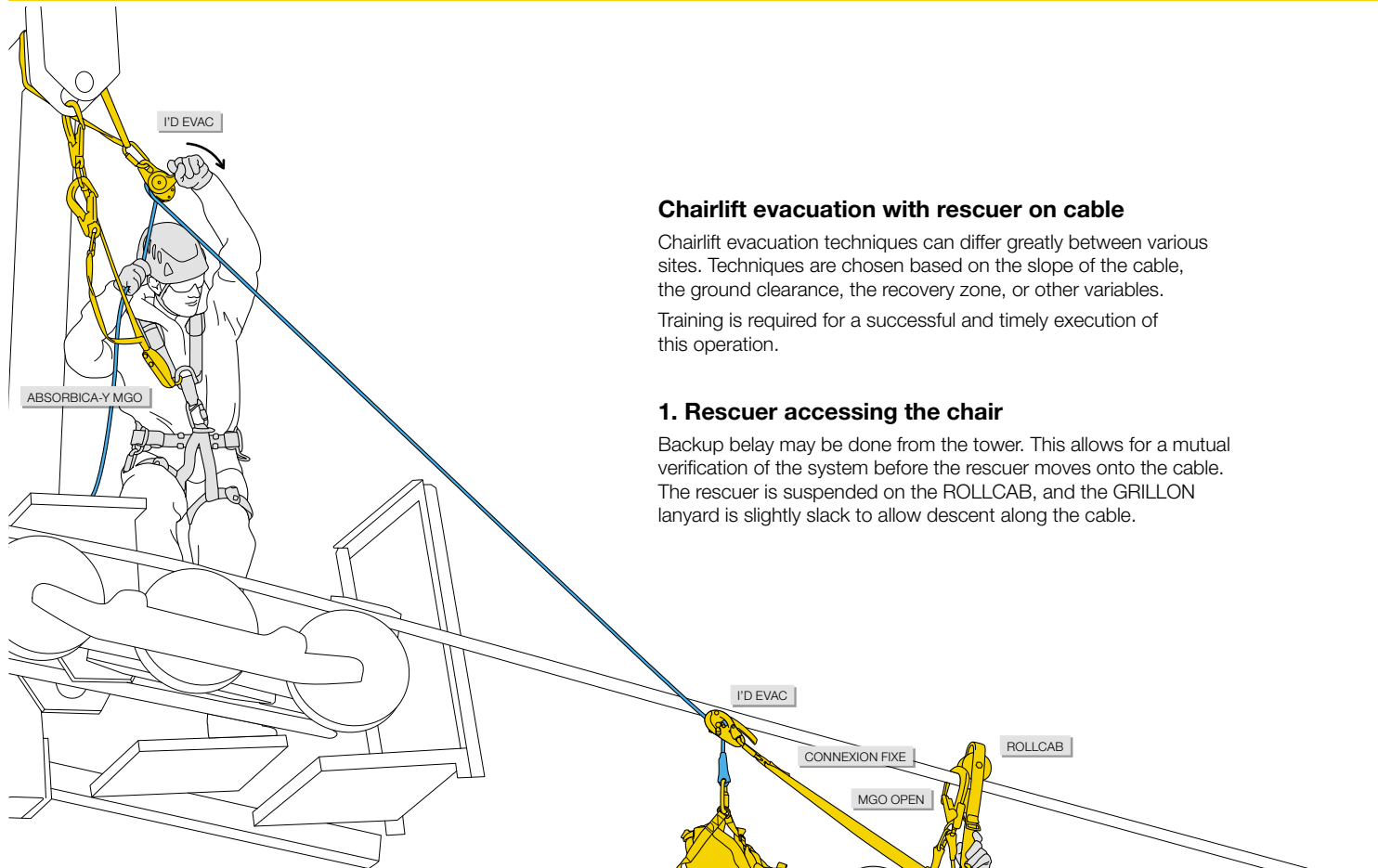

Chairlift evacuation with rescuer on cable

Chairlift evacuation techniques can differ greatly between various sites. Techniques are chosen based on the slope of the cable, the ground clearance, the recovery zone, or other variables.

Training is required for a successful and timely execution of this operation.

1. Rescuer accessing the chair

Backup belay may be done from the tower. This allows for a mutual verification of the system before the rescuer moves onto the cable.

The rescuer is suspended on the ROLLCAB, and the GRILLON lanyard is slightly slack to allow descent along the cable.

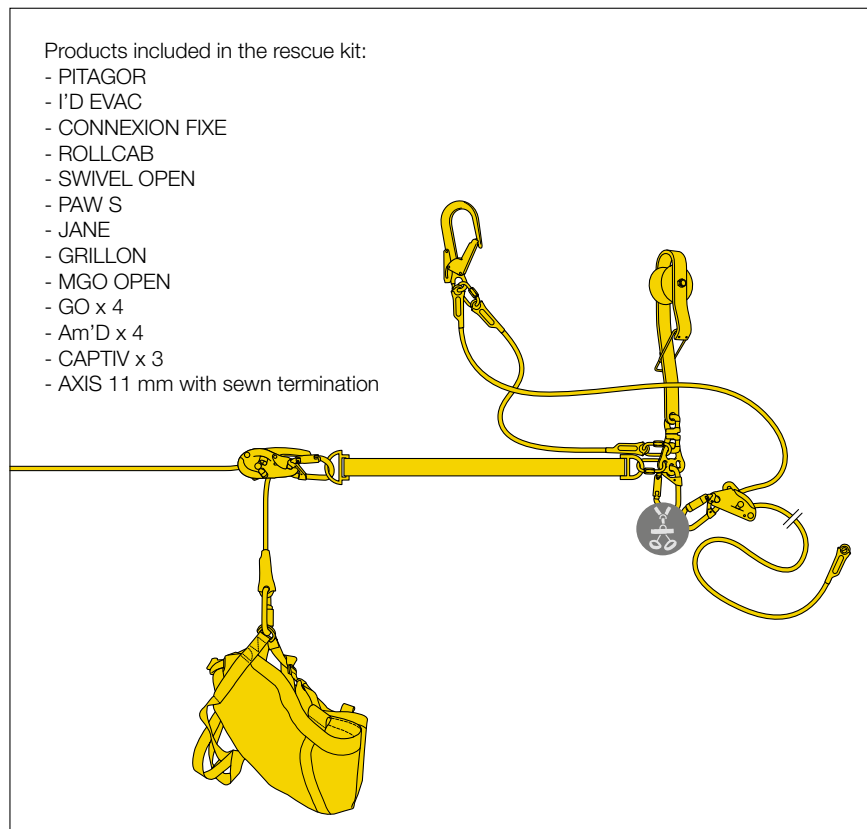



How to carry out a chairlift evacuation

2. Evacuating the passenger

The rescuer descends on the GRILLON lanyard to the chair. They install the PITAGOR evacuation triangle on the passenger, then evacuate them with an I'D EVAC descender.

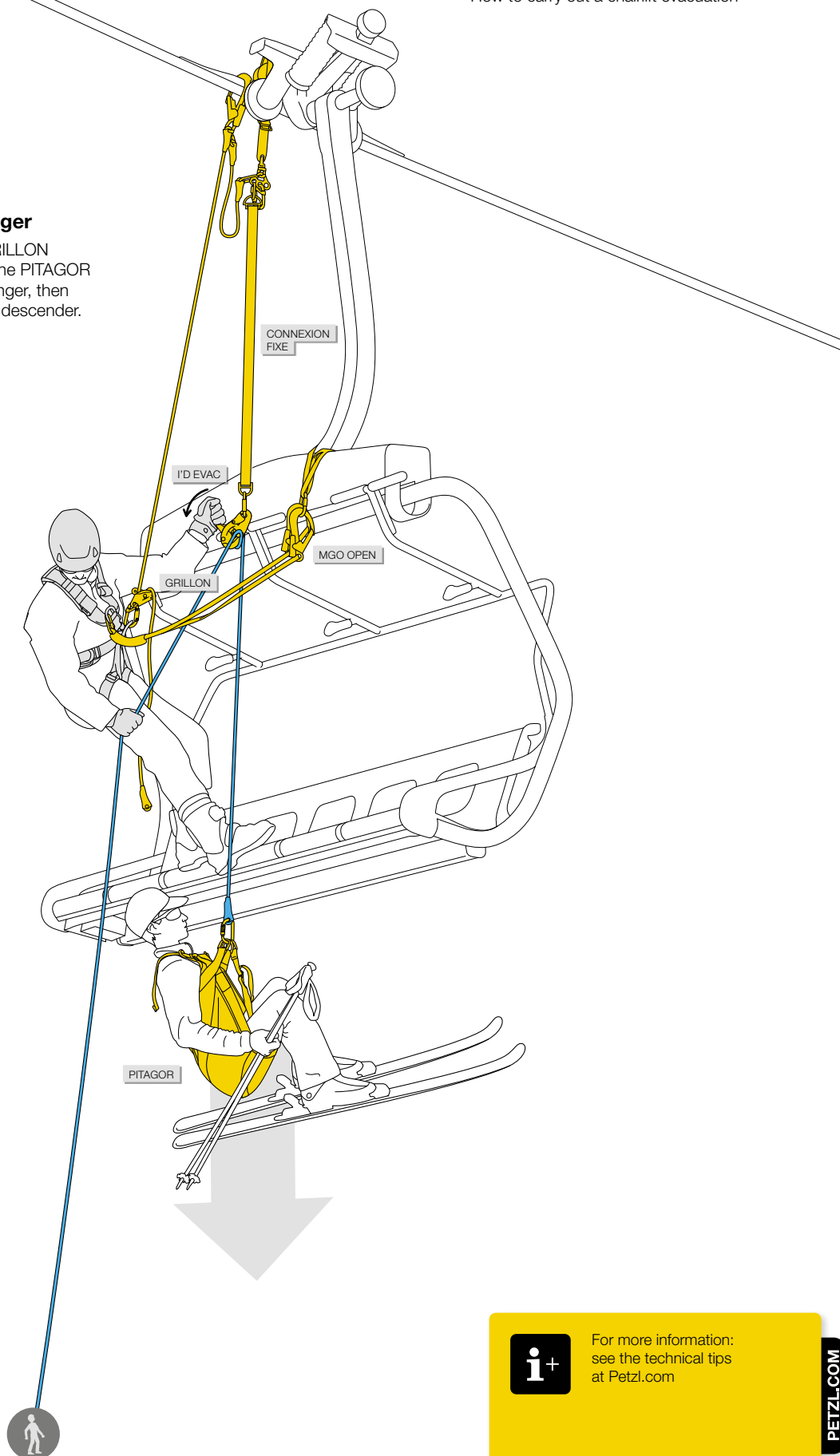

For more information:
see the technical tips
at [Petzl.com](https://www.petzl.com)

ePPEcentre Application

ePPEcentre is a Petzl application designed for professionals to facilitate PPE management.

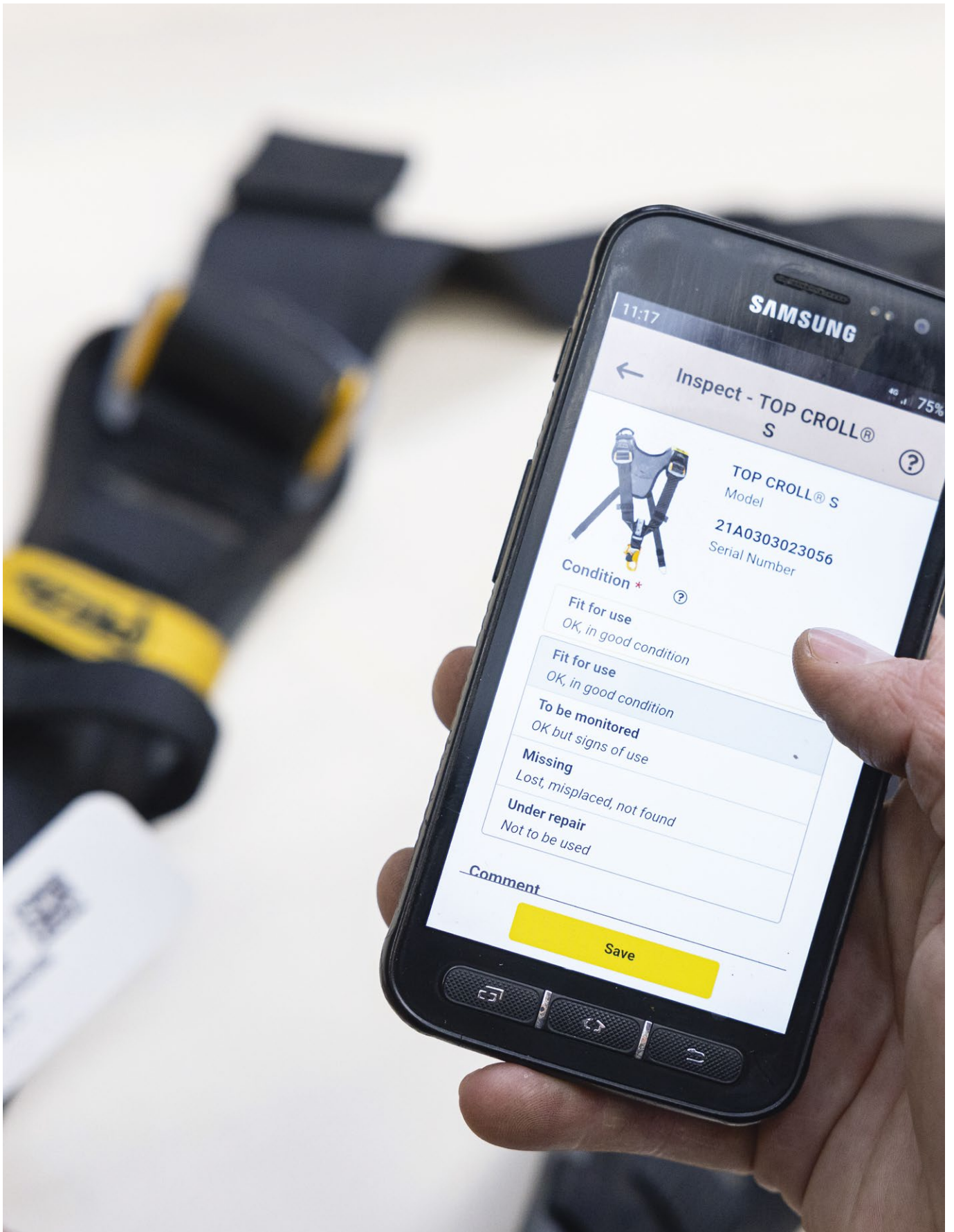

ePPE

CENTRE

Save Time

Simplified Management of Your Petzl PPE

- Add a Petzl product by simply scanning its datamatrix: all the information in our database that is related to the product will automatically populate
- Add products from other brands, as well
- Add photos and comments for context and to better monitor inspections
- Easily import and export your existing PPE data



© 2023 Petzl Distribution

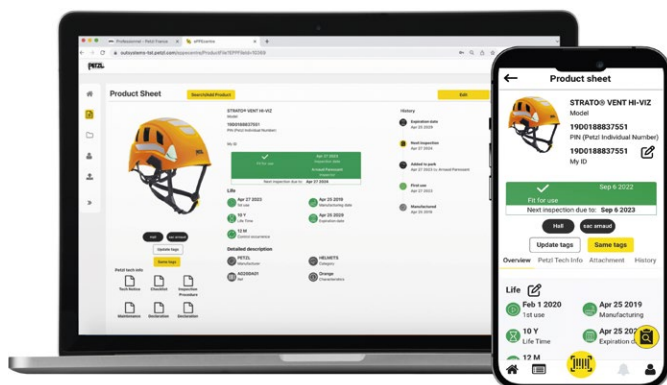

[Learn more](#)

See Overview of PPE at Any Time

- See an overview of your PPE with one quick glance at the dashboard on the home page: see the number of current products organized by status and immediately view the number of PPE inspections that need to be done in the coming days, weeks, and months
- View product history from the date of manufacture
- Access your data by installing the application on a mobile device, or on the computer via the ePPEcentre website

Customize Your PPE Management

- Choose the option that makes sense for you and your business (STARTER/PROFESSIONAL/ENTERPRISE). With PROFESSIONAL and ENTERPRISE, manage employee access by creating user profiles for your team (administrator, manager, inspector, viewer)
- Use tags to organize your products however you see fit (by family, users, location of use, etc.)
- Customize how your product list is displayed

Try ePPEcentre

To access the web version, go to:

epecentre.petzl.com

To access the mobile app, install it via your app store:



HELMETS

Essential for work at height and certain industrial activities, helmets provide the user with effective protection from falling objects, or in the event that the user falls.



Comfortable Helmets

Helmets with webbing suspension for optimal comfort.

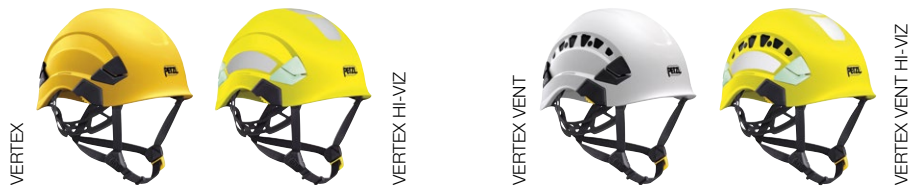

Lightweight Helmets

Lightweight, compact helmets with hybrid construction liner (EPP and EPS foams).

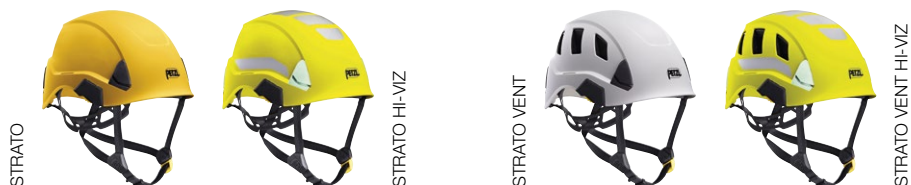

Protective Eye and Face Shields

Protective eye and face shields for VERTEX and STRATO helmets.



Accessories

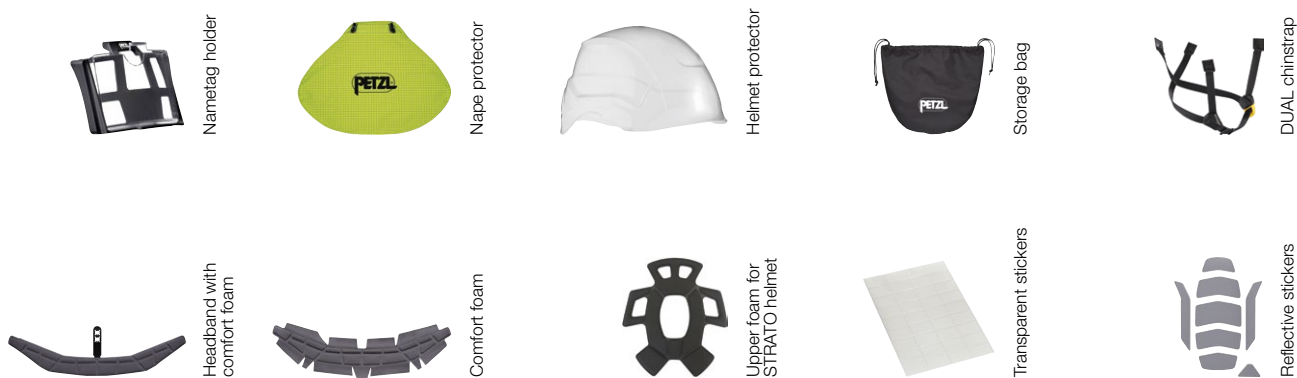

Hats and Balaclava

Hats and balaclava for protection against rain and cold.



Essential for work at height and certain industrial activities, helmets provide the user with effective protection from falling objects, or in the event that the user falls. With a very secure fit, Petzl helmets are comfortable to wear in a variety of different situations. With a complete line of entirely modular accessories, they meet the diverse needs of professionals.

• Excellent fit on the head

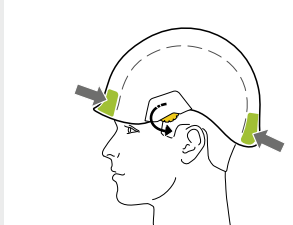

CENTERFIT adjustment

The CENTERFIT adjustment system allows the helmet to be perfectly centered on the head. The headband is easy to adjust by simultaneously rotating the two side adjustment wheels, even while wearing gloves.

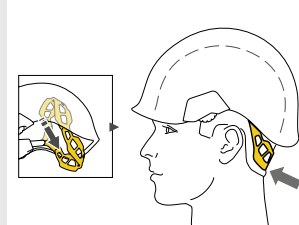

FLIP&FIT system

The FLIP&FIT system immediately positions the headband in a low position, to provide a secure fit on the head. The headband folds into the shell for easy storage and transport.



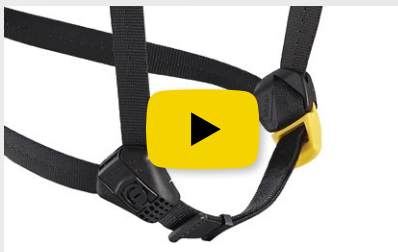



• DUAL chinstrap strength is adjustable, to adapt to a variety of different work situations



The DUAL chinstrap allows the worker to adjust chinstrap strength in order to adapt the helmet to different environments: work at height (EN 12492) or on the ground (EN 397). The clip has two positions, corresponding to the following two uses:

- Higher strength to limit the risk of the helmet coming off in a fall (strength > 50 daN)
- Lower strength to limit the risk of strangulation, by releasing if snagged when user is at ground level (strength < 25 daN)

Solution for Different Protection Needs

	Helmets With Unventilated Outer Shell		Helmets With Ventilated Outer Shell	
	VERTEX	STRATO	VERTEX VENT	STRATO VENT
  PENETRATION PROTECTION IMPACT PROTECTION	●		●	
 VENTILATION	-		●	
 ELECTRICAL PROTECTION	●		-	
 MOLTEN METAL PROTECTION	● Except HI-VIZ version		● Except HI-VIZ version	
 LATERAL DEFORMATION	●		●	

• **Modular accessories**

Extensive line of protective eye and face shields, headlamps, and accessories

- Eye shields, face shields for protection against electric arc hazards, specific shields for tree care
- Headlamps for lighting
- Nametag holder, nape protector, helmet protectors, chinstraps



Nametag holder



Helmet protector



Headlamp



Stickers



VIZIR / VIZIR SHADOW



Nape protector



VIZEN
VIZEN MESH



Headbands and foam



Storage bag

VERTEX
+ Nametag holder



VERTEX
+ PIXA R



STRATO VENT
+ VIZEN MESH
+ Nape protector



• A variety of choices



Available in assorted colors

VERTEX helmets are available in seven standard colors; STRATO helmets are available in four colors. VERTEX and STRATO helmets are also available in two HI-VIZ versions, with a fluorescent outer shell (yellow or orange), phosphorescent clips, and reflective bands for optimal visibility of the worker, day or night.

Multiple certifications

Depending on the model, Petzl helmets meet the requirements for the following certifications:

- European EN 397, EN 12492 and EN 50365
- American ANSI Z89.1
- Canadian CSA Z94.1
- Russian EAC
- Australian AS/NZS 1801
- Chinese GB 2811

• Easy to install and modular design

All Petzl helmets can be adapted to additional needs for protection or lighting in just a few seconds, thanks to the EASYCLIP system and a variety of inserts.

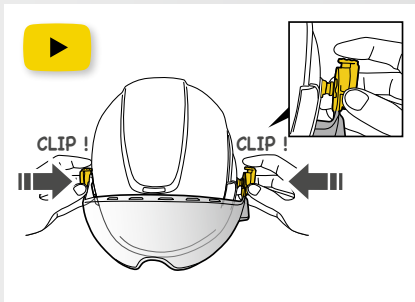

EASYCLIP

The EASYCLIP system allows quick installation of a protective shield. EASYCLIP is easy to install and is compatible with all Petzl helmets and shields. It comes with every protective eye and face shield.

• Petzl Custom for helmets



CUSTOM

Petzl Custom can:
- Customize the helmet with a logo and reflective stickers
- Pre-mount Petzl eye and face shields and accessories of your choice onto the helmet for a ready-made solution, with each helmet delivered in an individual transport pouch. Available for orders of 20 helmets or more.

• Comfortable construction



VERTEX helmets have a six-point webbing suspension system, conforming to the shape of the head for maximum comfort. Shock absorption is achieved through deformation of the external shell.

• Lightweight construction



The liner of STRATO helmets is designed in two parts: EPP (expanded polypropylene) and EPS (expanded polystyrene), for reduced weight. Shock absorption is achieved through deformation of the liner.

VERTEX and VERTEX VENT helmets



VERTEX®

Comfortable helmet

The VERTEX helmet is very comfortable, with its six-point textile suspension and CENTERFIT and FLIP&FIT systems, which provide a secure fit on the head. The adjustable-strength chinstrap makes it ideal for both work at height and on the ground. The unventilated outer shell protects against electrical hazards, molten metal splash, and flames. With its potential for integration of a Petzl headlamp, hearing protection, and multiple accessories, it is an entirely modular helmet, meeting the additional needs of professionals.



VERTEX® HI-VIZ

Comfortable high-visibility helmet

The high-visibility version features a fluorescent outer shell with phosphorescent clips and reflective bands for optimal visibility of the worker, day or night.



VERTEX® VENT

Comfortable ventilated helmet

The VERTEX VENT helmet is very comfortable, with its six-point textile suspension and CENTERFIT and FLIP&FIT systems, which provide a secure fit on the head. The adjustable-strength chinstrap makes it ideal for both work at height and on the ground. Ventilation holes with sliding shutters allow airflow through the helmet. With its potential for integration of a Petzl headlamp, hearing protection, and multiple accessories, it is an entirely modular helmet, meeting the additional needs of professionals.



VERTEX® VENT HI-VIZ

Comfortable, ventilated, high-visibility helmet

The high-visibility version features a fluorescent outer shell with phosphorescent clips and reflective bands for optimal visibility of the worker, day or night.

STRATO and STRATO VENT helmets



STRATO®

Lightweight helmet

The STRATO helmet is very lightweight and comfortable, with CENTERFIT and FLIP&FIT systems which provide a secure fit on the head. The adjustable-strength chinstrap makes it ideal for both work at height and on the ground. The unventilated outer shell protects against electrical hazards, molten metal splash, and flames. With its potential for integration of a Petzl headlamp, hearing protection, and multiple accessories, it is an entirely modular helmet, meeting the additional needs of professionals.



STRATO® HI-VIZ

Lightweight, high-visibility helmet

The high-visibility version features a fluorescent outer shell with phosphorescent clips and reflective bands for optimal visibility of the worker, day or night.



STRATO® VENT

Lightweight, ventilated helmet

The STRATO VENT helmet is very lightweight and comfortable, with CENTERFIT and FLIP&FIT systems which provide a secure fit on the head. The adjustable-strength chinstrap makes it ideal for both work at height and on the ground. Ventilation holes allow airflow through the helmet. With its potential for integration of a Petzl headlamp, hearing protection, and multiple accessories, it is an entirely modular helmet, meeting the additional needs of professionals.



STRATO® VENT HI-VIZ

Lightweight, ventilated, high-visibility helmet

The high-visibility version features a fluorescent outer shell with phosphorescent clips and reflective bands for optimal visibility of the worker, day or night.



 How to install a face shield



VIZIR

Eye shield with EASYCLIP system for VERTEX and STRATO helmets

The VIZIR eye shield protects the eyes against projectile hazards. It is easy to install on VERTEX and STRATO helmets with the EASYCLIP attachment system. It also has scratch resistant and anti-fog coatings.



VIZIR SHADOW

Tinted eye shield with EASYCLIP system for VERTEX and STRATO helmets

The VIZIR SHADOW eye shield provides eye protection against projectile hazards. It is easy to install on VERTEX and STRATO helmets with the EASYCLIP attachment system. It has a level 2.5 solar protection filter, and anti-scratch and anti-fog treatments.



VIZEN

Face shield for protection against electric arc hazards, with EASYCLIP system for VERTEX and STRATO helmets

The VIZEN face shield protects against electric arc hazards. This full-coverage shield offers face and eye protection while preserving peripheral vision. It is easily installed on VERTEX and STRATO helmets using the EASYCLIP attachment system. It also has scratch resistant and anti-fog coatings.



VIZEN MESH

Face shield for tree care for VERTEX and STRATO helmets, with EASYCLIP system

The VIZEN MESH face shield protects against flying wood chips and shavings. This full-coverage shield offers complete face protection while providing good visibility. It is easily installed on VERTEX and STRATO helmets using the EASYCLIP attachment system.



Nametag Holder for VERTEX® and STRATO® Helmets

The nametag holder for VERTEX and STRATO helmets allows quick identification of the worker. It is easy to install and provides effective rain protection for business cards.



Nape Protector for VERTEX® and STRATO® Helmets

The nape protector for VERTEX and STRATO helmets provides effective sun and rain protection for the nape of the neck. Fluorescent colors give the worker optimal visibility, night and day. Available in two colors.



Protector for VERTEX® Helmet

The protector for the VERTEX helmet is easy to install and protects the shell from soiling and splash.



Protector for STRATO® Helmet

The protector for the STRATO helmet is easy to install and protects the shell from soiling and splash.



Storage Bag for VERTEX® and STRATO® Helmets

Storage bag to protect VERTEX and STRATO helmets during storage and transport. It allows the worker to modify chinstrap strength in order to adapt the helmet to different environments: work at height or on the ground. Available in two colors and in a long version.



DUAL Chinstrap for VERTEX® and STRATO® Helmets

This chinstrap can be used to change or replace the chinstrap of VERTEX and STRATO helmets. It allows the worker to modify chinstrap strength in order to adapt the helmet to different environments: work at height or on the ground. Available in two colors and in a long version.



Helmets

Accessories



Headband With Comfort Foam for VERTEX® and STRATO® Helmets

Ready-to-install headband with comfort foam (standard or absorbent), to extend the lifespan of a VERTEX or STRATO helmet. Pack of 5.



Comfort Foam for VERTEX® and STRATO® Helmets

Comfort foam (standard or absorbent), to be installed on the headband of a VERTEX or STRATO helmet, to extend its lifespan.



Upper Foam for STRATO® Helmet

Upper foam installs on the liner of the STRATO helmet, to extend its lifespan. It is comfortable, absorbent, and machine-washable.



Transparent Stickers for VERTEX® and STRATO® Helmets

Transparent stickers allow VERTEX and STRATO helmets to be customized using a permanent marker or laser printer.



Reflective Stickers for VERTEX® Helmet

Reflective stickers for increased visibility of VERTEX helmets.



Reflective Stickers for STRATO® Helmet

Reflective stickers for increased visibility of STRATO helmets.

Hats and Balaclava

Buff® is a trademark and property of Original Buff®



LINER

Breathable cap for wicking perspiration

LINER is a breathable cap for wicking perspiration and drying quickly. The seamless fitted design makes it comfortable to wear under a helmet, without getting in the way.



BEANIE

Protective cap for cold and wind

BEANIE is a cap that protects the head on cold and windy days. The design, specific to each zone, optimizes thermal insulation and regulates moisture. The seamless fitted design and side vents make it comfortable to wear under a helmet, without getting in the way.



BALACLAVA

Balaclava for protection against cold and wind

BALACLAVA protects the head, face, and neck on cold, windy days. The design, specific to each zone, optimizes thermal insulation and regulates moisture. The seamless fitted design and multiple side vents make it comfortable to wear under a helmet, without getting in the way.



		Certifications	Weight
Eye and Face Shields			
VIZIR	A015AA00	CE EN 166, 1BT, ANSI Z87.1, EAC, GB 32166.1	80 g
VIZIR SHADOW	A015BA00	CE EN 166, 1BT, CE EN 172, 5-2,5, ANSI Z87.1, EAC, GB 32166.1	80 g
VIZEN	A014AA00	CE EN 166, 1BT8, CE EN 170, 2C-1,2, GS ET-29, Class 1, ANSI Z87.1, EAC	180 g
VIZEN MESH	A021AA00	CE EN 1731, ANSI Z87.1, EAC	117 g



		Colors	Versions	Weight
--	--	--------	----------	--------

Accessories				
Nametag Holder for VERTEX and STRATO Helmets	A018AA00	-	-	45 g
Nape Protector for VERTEX and STRATO Helmets	A019AA00	Yellow	-	55 g
	A019AA01	Orange	-	
Protector for VERTEX Helmet	A012AA00	-	-	60 g
Protector for STRATO Helmet	A012BA00	-	-	60 g
Storage Bag for VERTEX and STRATO Helmets	A022AA00	-	-	175 g
DUAL Chinstrap for VERTEX and STRATO Helmets	A010FA00	Yellow / Black	Standard	34 g
	A010FA01	Black	Standard	
	A010FA02	Yellow / Black	Extended	
Headband With Comfort Foam for VERTEX and STRATO Helmets	A010HA00	-	Standard	30 g
	A010JA00		Absorbent	
Comfort Foam for VERTEX and STRATO Helmets	A010KA00	-	Standard	15 g
	A010LA00		Absorbent	
Upper Foam for STRATO Helmet	A020EA00	-	-	15 g
Transparent Stickers for VERTEX and STRATO	A10100	-	-	-
Reflective Stickers for VERTEX	A010MA00	-	-	10 g
Reflective Stickers for STRATO	A020FA00	-	-	10 g



		Sizes	Head Circumference	Weight
--	--	-------	--------------------	--------



Hats and Balaclava				
LINER	A016AA00	M - L	56 - 59 cm	15 g
	A016AA01	L - XL	59 - 63 cm	
BEANIE	A016BA00	M - L	56 - 59 cm	25 g
	A016BA01	L - XL	59 - 63 cm	
BALACLAVA	A016CA00	M - L	56 - 59 cm	60 g
	A016CA01	L - XL	59 - 63 cm	





Helmets

		European Certifications	U.S. Certifications	Canadian Certification	Russian Certification	Australian Certification	Chinese Certification	IMPACT PROTECTION		PENETRATION PROTECTION	
								EN 397	EN 12492	ANSI Z89.1	EN 397

Comfortable Helmets

 VERTEX	A010AA00	<input type="checkbox"/>	CE EN 397 EN 50365 EN 12492 (6)	ANSI Z89.1 Type I Class E	CSA Z94.1 Type I Class E (5)	EAC	AS/NZS 1801	GB 2811	●	●	●	●	●
	A010AA01	<input type="checkbox"/>											
	A010AA02	<input type="checkbox"/>											
	A010AA03	<input type="checkbox"/>											
	A010AA04	<input type="checkbox"/>											
	A010AA05	<input type="checkbox"/>											
	A010AA06	<input type="checkbox"/>											
VERTEX HI-VIZ	A010DA00	<input type="checkbox"/>	CE EN 397 EN 50365 EN 12492 (6)	ANSI Z89.1 Type I Class E	CSA Z94.1 Type I Class E (5)	EAC	AS/NZS 1801	GB 2811	●	●	●	●	●
	A010DA01	<input type="checkbox"/>											
 VERTEX VENT	A010CA00	<input type="checkbox"/>	CE EN 12492 EN 397	ANSI Z89.1 Type I Class C	-	EAC	-	GB 2811	●	●	●	●	●
	A010CA01	<input type="checkbox"/>											
	A010CA02	<input type="checkbox"/>											
	A010CA03	<input type="checkbox"/>											
	A010CA04	<input type="checkbox"/>											
	A010CA05	<input type="checkbox"/>											
	A010CA06	<input type="checkbox"/>											
VERTEX VENT HI-VIZ	A010EA00	<input type="checkbox"/>	CE EN 12492 EN 397	ANSI Z89.1 Type I Class C	-	EAC	-	GB 2811	●	●	●	●	●
	A010EA01	<input type="checkbox"/>											

Lightweight Helmets

 STRATO	A020AA00	<input type="checkbox"/>	CE EN 397 (1) EN 50365 (2) EN 12492(6)	ANSI Z89.1 Type I Class E	-	EAC	-	GB 2811	●	●	●	●	●
	A020AA01	<input type="checkbox"/>											
	A020AA02	<input type="checkbox"/>											
	A020AA03	<input type="checkbox"/>											
STRATO HI-VIZ	A020CA00	<input type="checkbox"/>	CE EN 397 (1) EN 50365 (2) EN 12492(6)	ANSI Z89.1 Type I Class E	-	EAC	-	GB 2811	●	●	●	●	●
	A020CA01	<input type="checkbox"/>											
 STRATO VENT	A020BA00	<input type="checkbox"/>	CE EN 12492	ANSI Z89.1 Type I Class C	-	-	-	-	●	●	●	●	●
	A020BA01	<input type="checkbox"/>											
	A020BA02	<input type="checkbox"/>											
	A020BA03	<input type="checkbox"/>											
STRATO VENT HI-VIZ	A020DA00	<input type="checkbox"/>	CE EN 12492	ANSI Z89.1 Type I Class C	-	-	-	-	●	●	●	●	●
	A020DA01	<input type="checkbox"/>											

CHINSTRAP STRENGTH			VENTILATION		ELECTRICAL PROTECTION			MOLTEN METAL PROTECTION		FLAME RESISTANCE		LATERAL DEFORMATION		LOW TEMPERATURE		HIGH VISIBILITY		Head Circumference	Weight
EN 397 (3)	EN 12492 (4)	ANSI Z89.1	EN 12492	EN 397	EN 50365	ANSI Z89.1	EN 397	EN 397	ANSI Z89.1	EN 397	EN 397	ANSI Z89.1	ANSI Z89.1						
•	•	•	-	•	•	•	•	•	•	•	•	•	•	-	53-63 cm	490 g			
•	•	•	-	•	•	•	-	•	•	•	•	•	•	•	53-63 cm	495 g			
•	•	•	•	-	-	-	•	•	•	•	•	•	•	-	53-63 cm	490 g			
•	•	•	•	-	-	-	-	•	•	•	•	•	•	•	53-63 cm	495 g			
•	•	•	-	•	•	•	-	•	•	•	•	•	•	-	53-63 cm	435 g			
•	•	•	-	•	•	•	-	•	•	•	•	•	•	•	53-63 cm	445 g			
•	•	•	•	-	-	-	-	-	-	•	•	•	-	-	53-63 cm	415 g			
•	•	•	•	-	-	-	-	-	-	•	•	•	•	-	53-63 cm	425 g			



(4) Higher strength (> 50 daN) limits risk of helmet coming off in a fall. (5) For VERTEX Canada version. (6) Meets all requirements of the EN 12492 standard, except the ventilation requirement.

HARNESSES

Simple to use, comfortable, with numerous accessories and technically suited to the requirements of the work they are designed for, Petzl harnesses set the standard in terms of safety and efficiency for workers at height.



Historical building maintenance and repair, Central Park, New York City, New York, USA © 2024 Petzl Distribution - Vuedici.org - SPAR

To give each user the best possible fit, Petzl harnesses are adjustable at the waist, shoulders, and leg loops. They are equipped with different types of buckles:



FAST buckles
FAST buckles are fastened and unfastened quickly and easily without loss of adjustment, even when wearing gloves.



DOUBLEBACK self-locking buckles
These buckles do not require re-threading to be locked: they adjust easily in seconds.

General Purpose Harnesses

Fall-Arrest Harnesses

Fall-arrest harnesses with a simple, lightweight design.



NEWTON

NEWTON FAST

NEWTON EASYFIT

Fall-Arrest and Work-Positioning Harnesses

Fall-arrest and work-positioning harnesses that are comfortable and easily donned.



VOLT

VOLT WIND

Harnesses for Fall Arrest, Work Positioning, and Suspension

Versatile and very comfortable harnesses for fall arrest, work positioning, and suspension.



NEW 2025

AVAO
AVAO FAST

NEW 2025

AVAO SIT
AVAO SIT FAST

NEW 2025

TOP

Specialized Harnesses

Rope Access Harnesses

Very comfortable harnesses, with integrated ventral rope clamp to facilitate ascending a rope.

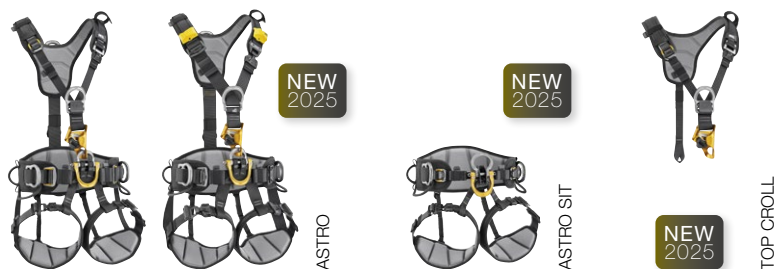

NEW 2025

ASTRO

NEW 2025

ASTRO SIT

NEW 2025

TOP GROLL

Tree Care Harnesses

Very comfortable harnesses, with attachment bridge for greater freedom of movement in the trees.



SEQUOIA SRT

SEQUOIA

Rescue Harnesses

Lightweight harnesses suitable for various rescue environments.



FALCON

FALCON ASCENT

FALCON MOUNTAIN

Evacuation Triangles and Litter

Equipment designed for rope rescue (such as in confined spaces or on cable lifts).



THALES

PITAGOR

NEST
STEF



Fall-Arrest Harnesses European Version

Certified to European and Russian standards, these harnesses are designed specifically for fall arrest. More specifically, they allow for the attachment of ABSORBICA energy-absorbing lanyards or an ASAP or ASAP LOCK mobile fall arrester.

• Lightweight, ergonomic design

NEWTON harnesses are designed to avoid interfering with the movement of the worker. The anatomical and lightweight design is close-fitting yet allows optimal freedom of movement.



How to put on the NEWTON harness

• Easy to use



Easy to fasten and unfasten harness

The FAST LT PLUS sternal buckle allows the harness to be quickly and easily fastened and unfastened without loss of adjustment, even with gloves. The buckle's locking system limits the risk of accidental unfastening.



Ready access to tools

The equipment loops simplify tool organization, and the slots allow a TOOLBAG pouch to be added.

• Versatile



Textile sternal attachment point

Lightweight and abrasion resistant, the textile sternal attachment point allows attachment of a fall-arrest system.



Metal dorsal attachment point

Made of anodized aluminum for high strength, the dorsal attachment point allows attachment of a fall-arrest system.

• Great simplicity



NEWTON harnesses have color-coded (yellow/black) straps allowing rapid identification of the upper and lower parts of the harness before donning.

• Quick donning



Equipped with padded shoulder straps and FAST LT buckles on the leg loops, the NEWTON FAST harness dons very easily with both feet on the ground, without loss of adjustment.

• Optimal comfort



The NEWTON EASYFIT harness is designed to keep its shape, and includes two pockets for stowing small items. The leg loops are padded and equipped with FAST LT buckles, enabling the harness to be easily donned while keeping both feet on the ground, without loss of adjustment.

NEWTON Harnesses



NEWTON European Version

Fall-arrest harnesses

NEWTON is a lightweight, ergonomic fall-arrest harness. It is easy to use and its straps are color-coded to make donning easier. The harness allows immediate access to tools, with equipment loops and slots for the TOOLBAG pouch. Its textile sternal attachment point and metal dorsal attachment point provide tremendous versatility. It is certified to European and Russian standards.



NEWTON FAST European Version

Quick-donning fall-arrest harness

NEWTON FAST is a lightweight, ergonomic fall-arrest harness that can be quickly donned. It is equipped with padded shoulder straps and FAST LT buckles on the leg loops, allowing the harness to be donned with both feet on the ground, without loss of adjustment. The harness allows immediate access to tools, with equipment loops and slots for the TOOLBAG pouch. Its textile sternal attachment point and metal dorsal attachment point provide tremendous versatility. It is certified to European and Russian standards.



NEWTON EASYFIT European Version

Comfortable and quick-donning fall-arrest harness

NEWTON EASYFIT is a comfortable, ergonomic fall-arrest harness that can be quickly donned. It is equipped with padded shoulder straps and FAST LT buckles on the leg loops, allowing the harness to be donned with both feet on the ground, without loss of adjustment. Its lightweight, breathable design offers two zippered pockets for storing small items. The harness allows immediate access to tools, with equipment loops and slots for the TOOLBAG pouch. Its textile sternal attachment point and metal dorsal attachment point provide tremendous versatility. It is certified to European and Russian standards.

Accessories



HI-VIZ Vest for NEWTON Harnesses

Fluorescent-colored vest with reflective strips makes the worker highly visible in a variety of lighting conditions. It installs quickly and easily on NEWTON, NEWTON FAST, and NEWTON EASYFIT harnesses. The sternal buckle, multiple attachment points, and lanyard connector parking all remain accessible during use for optimal freedom of movement.



Leg Loop Padding for NEWTON Harnesses

Leg loop padding that can be added to NEWTON and NEWTON FAST harnesses to increase comfort, or used as replacement padding on NEWTON EASYFIT harnesses.



Fall-Arrest Harnesses International Version

Certified to North American, European, and Russian standards, these harnesses are designed specifically for fall arrest. More specifically, they allow for the attachment of ABSORBICA energy-absorbing lanyards or an ASAP or ASAP LOCK mobile fall arrester.

• Lightweight, ergonomic design

NEWTON harnesses are designed to avoid interfering with the movement of the worker. The anatomical and lightweight design is close-fitting yet allows optimal freedom of movement.



How to put on the NEWTON harness

• Easy to use



Easy to fasten and unfasten harness

The FAST LT PLUS sternal buckle allows the harness to be quickly and easily fastened and unfastened without loss of adjustment, even with gloves. The buckle's locking system limits the risk of accidental unfastening.

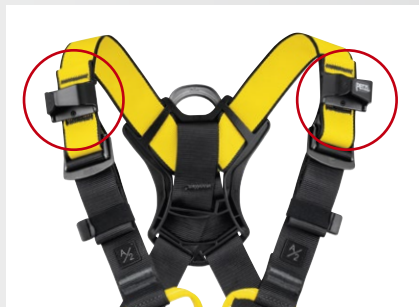

Lanyard connector parking

The harnesses have a parking system for fall-arrest lanyard connectors on each shoulder strap. In the event of a fall, the system releases the MGO connector and allows the absorber to be deployed.

• Versatile

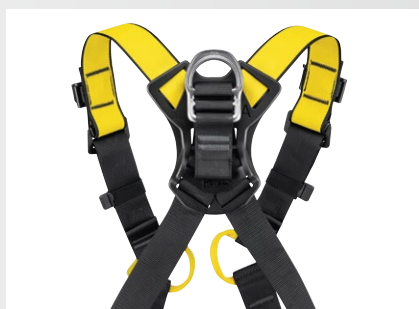

The harnesses have a metal dorsal attachment point that allows attachment of a fall-arrest system, and a textile dorsal attachment point that allows attachment of a self-retracting fall-arrest system.

• Easy harness inspection



The sternal and dorsal attachment points are equipped with visual indicators: a red tag appears after a fall to indicate that the harness must be retired.

• Great simplicity



NEWTON harnesses have color-coded (yellow/black) straps allowing rapid identification of the upper and lower parts of the harness before donning.

• Quick donning



Equipped with padded shoulder straps and FAST LT PLUS buckles on the leg loops, the NEWTON FAST harness dons very easily with both feet on the ground, without loss of adjustment.

• Optimal comfort



The NEWTON EASYFIT harness is designed to keep its shape, and includes two pockets for stowing small items. The leg loops are padded and equipped with FAST LT PLUS buckles, enabling the harness to be easily donned while keeping both feet on the ground, without loss of adjustment.

▶ NEWTON Harnesses



NEWTON International Version

Fall-arrest harnesses

NEWTON is a lightweight, ergonomic fall-arrest harness. It is easy to use and its straps are color-coded to make donning easier. The harness allows immediate access to tools, with equipment loops and slots for the TOOLBAG pouch. Its textile sternal attachment point and metal and textile dorsal attachment points provide tremendous versatility. It ergonomically stows MGO connectors and has fall indicators. It is certified to North American, European, and Russian standards.



NEWTON FAST International Version

Quick-donning fall-arrest harness

NEWTON FAST is a lightweight, ergonomic fall-arrest harness that can be quickly donned. It is equipped with padded shoulder straps and FAST LT PLUS buckles on the leg loops, allowing the harness to be donned with both feet on the ground, without loss of adjustment. The harness allows immediate access to tools, with equipment loops and slots for the TOOLBAG pouch. Its textile sternal attachment point and metal and textile dorsal attachment points provide tremendous versatility. It ergonomically stows MGO connectors and has fall indicators. It is certified to North American, European, and Russian standards.



NEWTON EASYFIT International Version

Comfortable and quick-donning fall-arrest harness

NEWTON EASYFIT is a comfortable, ergonomic fall-arrest harness that can be quickly donned. It is equipped with padded shoulder straps and FAST LT PLUS buckles on the leg loops, allowing the harness to be donned with both feet on the ground, without loss of adjustment. Its lightweight, breathable design offers two zippered pockets for storing small items. The harness allows immediate access to tools, with equipment loops and slots for the TOOLBAG pouch. Its textile sternal attachment point and metal and textile dorsal attachment points provide tremendous versatility. It ergonomically stows MGO connectors and has fall indicators. It is certified to North American, European, and Russian standards.

Accessories



HI-VIZ Vest for NEWTON Harnesses

Fluorescent-colored vest with reflective strips makes the worker highly visible in a variety of lighting conditions. It installs quickly and easily on NEWTON, NEWTON FAST, and NEWTON EASYFIT harnesses. The sternal buckle, multiple attachment points, and lanyard connector parking all remain accessible during use for optimal freedom of movement.



Leg Loop Padding for NEWTON Harnesses

Leg loop padding that can be added to NEWTON and NEWTON FAST harnesses to increase comfort, or used as replacement padding on NEWTON EASYFIT harnesses.



Fall-Arrest and Work-Positioning Harnesses

These harnesses help provide fall protection for the worker and enable them to position themselves at a workstation, with a GRILLON lanyard, for example. Additionally, they are specifically designed to facilitate vertical progression on a rail or cable (European versions only).

• Quick and easy donning



VOLT and VOLT WIND harnesses are very quick to don. The waistbelt and leg loops are equipped with FAST LT PLUS/FAST LT buckles, allowing the harness to be easily donned while keeping both feet on the ground.

• Optimal comfort



Comfortable work positioning

The wide, semi-rigid waistbelt and leg loops provide excellent support. The lightweight, breathable construction maximizes air flow.



Ventral attachment point suitable for vertical progression on a rail or cable

The LADDER CLIMB attachment point allows for ventral attachment of the fall-arrest trolley, which distributes the load on the waistbelt, providing optimal comfort. In the event of a fall, the attachment point automatically moves upward to a sternal position to help keep the body in a vertical post-fall position (only on European versions).



Folding side attachment points

Side attachment points can be folded down to prevent them snagging accidentally when not in use.

• Easy to use

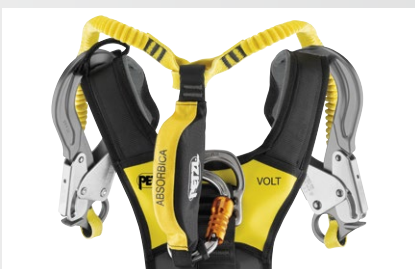

The harnesses have a parking system for the MGO connectors on fall-arrest lanyards on each shoulder strap. In the event of a fall, the system releases the MGO connectors and allows the absorber to be deployed.

• For work on towers and antennas



VOLT harnesses have a wide waistbelt with equipment loops on the back for easy organization of work tools.

• For work inside wind turbine towers



VOLT WIND harnesses have dorsal wear protectors to reduce wear on the straps when moving about inside a wind turbine tower.



VOLT® European Version

Fall-arrest and work-positioning harness with attachment point for vertical progression on rail or cable

The VOLT fall-arrest and work-positioning harness is very quick to don, thanks to the FAST LT PLUS and FAST LT buckles that allow it to be donned with both feet on the ground. The wide, semi-rigid waistbelt and leg loops provide excellent support. Its lightweight, breathable construction maximizes air flow. Its LADDER CLIMB attachment point allows for ventral attachment of the fall-arrest trolley, providing optimal comfort during progression. It is certified to European and Russian standards.



VOLT® International Version

Fall-arrest and work-positioning harness

The VOLT fall-arrest and work-positioning harness is very quick to don, thanks to the FAST LT PLUS buckles that allow it to be donned with both feet on the ground. The wide, semi-rigid waistbelt and leg loops provide excellent support. Its lightweight, breathable construction maximizes air flow. It features a textile dorsal attachment point designed for connecting a self-retracting fall-arrest system. It is certified to North American and European standards.

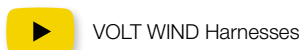

VOLT® WIND European Version

Fall-arrest and work-positioning harness for the wind power industry with attachment point for vertical progression on rail or cable

The VOLT WIND fall-arrest and work-positioning harness is very quick to don, thanks to the FAST LT PLUS and FAST LT buckles that allow it to be donned with both feet on the ground. The wide, semi-rigid waistbelt and leg loops provide excellent support. Its lightweight, breathable construction maximizes air flow. Its LADDER CLIMB attachment point allows for ventral attachment of the fall-arrest trolley, providing optimal comfort during progression. It has wear protectors on the waistbelt and dorsal point to limit wear when moving about inside the wind turbine tower. It is certified to European and Russian standards.



VOLT® WIND International Version

Fall-arrest and work-positioning harness for the wind power industry

The VOLT WIND fall-arrest and work-positioning harness is very quick to put on, thanks to the FAST LT PLUS buckles that allow it to be donned with both feet on the ground. The wide, semi-rigid waistbelt and leg loops provide excellent support. Its lightweight, breathable construction maximizes air flow. It features a textile dorsal attachment point designed for connecting a self-retracting fall-arrest system. It has wear protectors on the waistbelt and dorsal point to limit wear when moving about inside the wind turbine tower. It is certified to North American and European standards.

Accessories

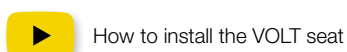

Seat for VOLT® Harnesses

Seat for VOLT harnesses for greater comfort while suspended

The seat for the VOLT harness attaches to the designated slots on the harness. It provides additional comfort during prolonged suspension.



Harnesses for Fall Arrest, Work Positioning, and Suspension

Harnesses in the AVAO range are specifically designed for workers at height. Their design is specific to positioning and rope descent.

• Comfortable construction



All contact zones, including the shoulder straps, waistbelt and leg loops, use contoured foam and are lined with breathable material, making work more comfortable for professionals. Semi-rigid waistbelt and leg loops provide optimal harness fit and support.

• Equipment organization

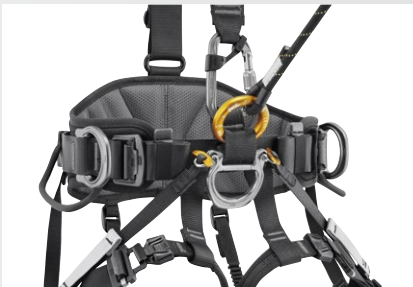

Equipment integration

The ventral connection point consists of a textile loop and a metal D ring for integrating a positioning lanyard, a descender, or a PODIUM or LITEPOD work seat.



Organize equipment

The waistbelt is equipped with two side metal attachment points for connecting a positioning lanyard in double mode. Five equipment loops, two slots for CARITool tool holders and INTERFAST connection system allow the user to organize all the necessary equipment for a day of work.

• Easy to install and adjust



Easy to don

The AVAO FAST and AVAO SIT FAST harnesses are equipped with FAST opening buckles on the leg loops, making it easier to put on and take off, even while wearing gloves.



Easy to adjust

Adjusting the harness is easy with self-locking DOUBLEBACK buckles. They're equipped with an anti-slip device that helps the buckle maintain the right adjustment throughout the workday.

• A complete solution with dorsal attachment point



The AVAO and AVAO FAST full-body harnesses are equipped with a dorsal attachment point for connecting a fall-arrest system.

• A lightweight and modular solution



Combining an AVAO SIT harness with a TOP chest harness provides a modular, lightweight solution if the user does not need a dorsal attachment point.

NEW
2025



AVAO® / AVAO® FAST European Version

Comfortable and versatile harness for work at height

The AVAO harness is specifically designed for workers at height. Its design is specific to work positioning and rope descent. Contoured foam on the semi-rigid waistbelt and leg loops provide comfort during use. The waistbelt features metal side attachment points, equipment loops, and tool holder slots, allowing the user to organize all the necessary equipment for a day of work. Adjustment is quick and easy with self-locking DOUBLEBACK buckles and FAST opening buckles (AVAO FAST).

NEW
2025



AVAO® / AVAO® FAST International Version

Comfortable and versatile harness for work at height

The AVAO harness is specifically designed for workers at height. Its design is specific to work positioning and rope descent. Contoured foam on the semi-rigid waistbelt and leg loops provide comfort during use. The waistbelt features metal side attachment points, equipment loops, and tool holder slots, allowing the user to organize all the necessary equipment for a day of work. Adjustment is quick and easy with self-locking DOUBLEBACK buckles and FAST opening buckles (AVAO FAST).

NEW
2025



TOP

Chest harness for sit harness

The TOP chest harness transforms AVAO SIT, AVAO SIT FAST, FALCON, FALCON MOUNTAIN, and SEQUOIA SRT sit harnesses into fall-arrest harnesses. The padded shoulder straps are widely spaced to reduce neck chafing. The TOP chest harness helps distribute the load over the shoulders when the waistbelt is loaded.

NEW
2025



AVAO® SIT / AVAO® SIT FAST

Comfortable and versatile sit harness for work at height

The AVAO SIT sit harness is specifically designed for workers at height looking for a lightweight and modular solution. It can be turned into a full-body fall-arrest harness by connecting a TOP or TOP CROLL chest harness. Its design is specific to work positioning and rope descent. Contoured foam on the semi-rigid waistbelt and leg loops provide comfort during use. The waistbelt features metal side attachment points, equipment loops, and tool holder slots, allowing the user to organize all the necessary equipment for a day of work. Adjustment is quick and easy with self-locking DOUBLEBACK buckles and FAST opening buckles on the leg loops (AVAO SIT FAST).

Accessories

NEW
2025



PODIUM

Comfortable work seat designed for prolonged suspension

The PODIUM work seat allows work-at-height and rope access technicians to sit when suspended in their harness for long periods of work, providing additional comfort. It features three equipment loops and is easily adjustable, with DOUBLEBACK buckles. It can be connected to the harness with T-BARS, which can be attached directly to the shackles, or with connectors or accessory carabiners such as the MINO. A replacement covering for the PODIUM work seat is available as an accessory.

NEW
2025



LITEPOD

Compact work seat designed for prolonged suspension

The LITEPOD work seat allows work-at-height and rope access technicians to sit when suspended in their harness for long periods of work, providing additional comfort. It features two equipment loops and is easily adjustable, with DOUBLEBACK buckles. It can be connected to the harness with T-BARS, which can be attached directly to the shackles, or with connectors or accessory carabiners such as the MINO. A replacement covering for the LITEPOD work seat is available as an accessory.



Rope Access Harnesses

Harnesses in the ASTRO range are designed for rope access technicians. Their design is specific to movement and rope ascent.

- **Comfortable design**



All contact zones (shoulder straps, waistbelt and leg loops) use 3D foam padding and are lined with breathable material for more comfort while suspended and throughout the workday. Semi-rigid waistbelt and leg loops provide optimal harness fit and support.

- **Equipment integration and organization**

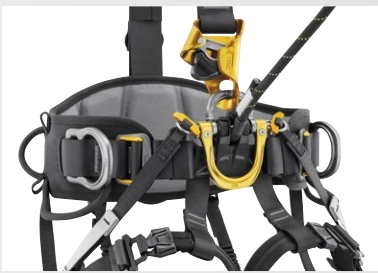

- **Optimally integrate equipment**

The gated ventral point on the ASTRO harness allows optimal integration of equipment for rope progression, as well as a PODIUM or LITEPOD work seat.



- **Organize equipment**

The waistbelt is equipped with two side metal attachment points for connecting a positioning lanyard in double mode. Seven equipment loops, two slots for CARITool tool holders and INTERFAST connection system, and two loops for TOOLBAG tool pouches allow the user to install and organize all the necessary equipment for a day of work.

- **Easy to put on**



Shoulder straps have a FAST opening buckle on the left, making it easy to put on and take off; and a DOUBLEBACK self-locking buckle on the right with an anti-slip device, for easy adjustments that don't slip.

- **Convenient adjustment system**

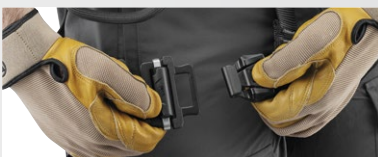

- **Easy to don**

Leg loops are equipped with FAST opening buckles that allow the harness to be donned with both feet on the ground without loss of adjustment, even while wearing gloves.

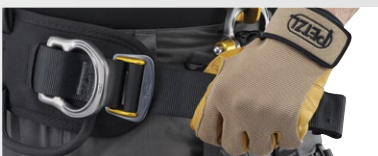

- **Easy to adjust**

Waistbelt equipped with self-locking DOUBLEBACK buckles for quick and easy adjustment.

- **A complete solution with dorsal attachment point**



ASTRO full-body harnesses are equipped with a dorsal attachment point for attaching a fall-arrest system. On the international version, in the event of a fall on the dorsal attachment point, a red indicator appears, signaling that the harness should be retired.

- **A lightweight and modular solution**



Combining an ASTRO SIT harness with the TOP CROLL chest harness provides a modular, lightweight solution. The bridge construction makes lateral movement easier.

NEW
2025



ASTRO® European Version

Ultra-comfortable harness for rope access

The ASTRO harness is designed for rope access technicians. Its design is specific to movement and rope ascent. The 3D foam padding and semi-rigid waistbelt and leg loop construction provide comfort throughout the workday. The gated ventral attachment point allows the user to efficiently install the necessary equipment for progression. The integrated CROLL L rope clamp improves efficiency for rope ascent. The waistbelt features metal side attachment points, equipment loops, and tool holder slots, allowing the user to organize and carry all the necessary equipment for a day of work. DOUBLEBACK PLUS self-locking buckles and FAST opening buckles make donning and adjusting the harness simple and convenient, even while wearing gloves.

NEW
2025



ASTRO® International Version

Ultra-comfortable harness for rope access

The ASTRO harness is designed for rope access technicians. Its design is specific to movement and rope ascent. The 3D foam padding and semi-rigid waistbelt and leg loop construction provide comfort throughout the workday. The gated ventral attachment point allows the user to efficiently install the necessary equipment for progression. The integrated CROLL L rope clamp improves efficiency for rope ascent. The waistbelt features metal side attachment points, equipment loops, and tool holder slots, allowing the user to organize and carry all the necessary equipment for a day of work. DOUBLEBACK self-locking buckles and FAST opening buckles make donning and adjusting the harness simple and convenient, even while wearing gloves.

NEW
2025



TOP CROLL®

Chest harness for sit harness, with integrated CROLL L ventral rope clamp

The TOP CROLL chest harness transforms AVAO SIT, AVAO SIT FAST, ASTRO SIT, FALCON, FALCON ASCENT, FALCON MOUNTAIN, and SEQUOIA SRT sit harnesses into full-body harnesses for work at height and rope access. The padded shoulder straps are widely spaced to reduce neck chafing. The TOP CROLL chest harness helps distribute the load over the shoulders when the waistbelt is loaded.

NEW
2025



ASTRO® SIT

Ultra-comfortable sit harness for rope access

The ASTRO SIT sit harness is specifically designed for workers at height and rope access technicians looking for a lightweight and modular solution. It can be made into a full-body fall-arrest harness by connecting a TOP CROLL chest harness, for ascending a rope. The 3D foam padding and semi-rigid waistbelt and leg loop construction provide comfort throughout the workday. The textile bridge construction provides ease of movement and comfort when walking. The gated ventral attachment point allows the user to efficiently install the necessary equipment for progression. The waistbelt features metal side attachment points, equipment loops, and tool holder slots, allowing the user to organize and carry all the necessary equipment for a day of work. DOUBLEBACK self-locking buckles and FAST opening buckles make donning and adjusting the harness simple and convenient, even while wearing gloves.

Accessories

NEW
2025



PODIUM

Comfortable work seat designed for prolonged suspension

The PODIUM work seat allows work-at-height and rope access technicians to sit when suspended in their harness for long periods of work, providing additional comfort. It features three equipment loops and is easily adjustable, with DOUBLEBACK buckles. It can be connected to the harness with T-BARS, which can be attached directly to the shackles, or with connectors or accessory carabiners such as the MINO. A replacement covering for the PODIUM work seat is available as an accessory.

NEW
2025



LITEPOD

Compact work seat designed for prolonged suspension

The LITEPOD work seat allows work-at-height and rope access technicians to sit when suspended in their harness for long periods of work, providing additional comfort. It features two equipment loops and is easily adjustable, with DOUBLEBACK buckles. It can be connected to the harness with T-BARS, which can be attached directly to the shackles, or with connectors or accessory carabiners such as the MINO. A replacement covering for the LITEPOD work seat is available as an accessory.



Tree Care Harnesses

These harnesses are designed for arborists: they allow great mobility in the tree and optimally distribute the load between the waistbelt and the leg loops. They also provide excellent lumbar support in the many work phases where the arborist has their weight on the harness.

• Comfortable



The semi-rigid, extra-wide waistbelt provides excellent support for the user. It is also sculpted and lined with foam padding for improved comfort while suspended.

• Ergonomic

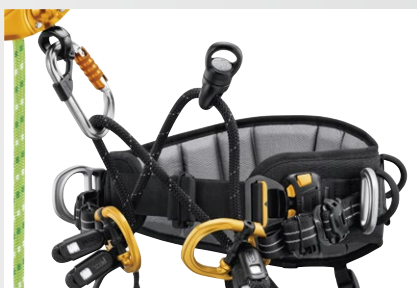

Gated attachment points

The gated attachment points facilitate connection of a ZILLON or MICROFLIP lanyard. They also allow installation of several attachment bridges (adjustable or fixed), as well as accessories like RING attachment rings or SWIVELS, directly on the attachment bridge.



Easy to don

The leg loops of SEQUOIA harnesses are equipped with FAST LT PLUS buckles that facilitate donning the harness with both feet on the ground or with large footwear, without loss of adjustment, even when wearing gloves.

• Accessories

Accessories for the SEQUOIA line of harnesses allow each user to adapt the equipment to their needs.



• For single rope ascent techniques

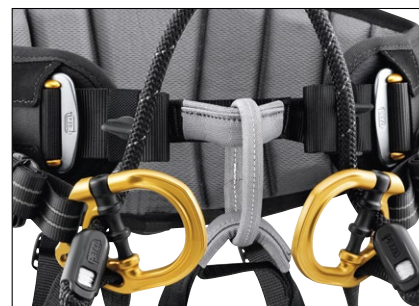

The SEQUOIA SRT features a ventral attachment point for installing a ZIGZAG mechanical Prusik with the CHICANE and KNEE ASCENT accessories.

• For doubled rope ascent techniques



The SEQUOIA harness waistbelt is equipped with a FAST buckle for quick and simple fastening and unfastening without loss of adjustment, even while wearing gloves.

[▶ How to Install an Adjustable Attachment Bridge On the SEQUOIA Harness](#)

[▶ How to Use an Adjustable Attachment Bridge On the SEQUOIA Harness](#)

SEQUOIA SRT harnesses



SEQUOIA® SRT

Tree care sit harness for single-rope ascent techniques

The SEQUOIA SRT is a tree care sit harness for single rope ascent techniques. It has a ventral attachment point that allows a ZIGZAG or ZIGZAG PLUS mechanical Prusik to be installed with CHICANE and KNEE ASCENT accessories. The extra-wide, semi-rigid waistbelt and leg loops provide comfort for the arborist. It is equipped with DOUBLEBACK PLUS self-locking buckles on the waistbelt and FAST LT PLUS buckles on the leg loops. The gated attachment points allow the user to easily connect a ZILLON or MICROFLIP lanyard, or to install several attachment bridges and accessories directly on the bridge. The harness also makes it easy to carry and organize work tools, with multiple equipment loops and slots for attaching CARITOOL tool holders.



SEQUOIA®

Tree care sit harness for doubled rope ascent techniques

The SEQUOIA is a tree care sit harness for doubled rope ascent techniques. The extra-wide, semi-rigid waistbelt and leg loops provide comfort for the arborist. The waistbelt is equipped with a FAST buckle for quick and easy fastening and unfastening without loss of adjustment, even while wearing gloves. The leg loops have FAST LT PLUS buckles. The gated attachment points allow the user to easily connect a ZILLON or MICROFLIP lanyard, or to install several attachment bridges and accessories directly on the bridge. The harness also makes it easy to carry and organize work tools, with multiple equipment loops and slots for attaching CARITOOL tool holders.

Accessories

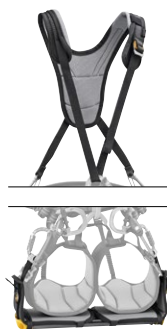

Shoulder Straps (Only for SEQUOIA® SRT)

Shoulder straps for SEQUOIA SRT sit harness designed for taking the load from the waistbelt and redistributing it to the shoulders for improved comfort. They connect to the ventral attachment point of the harness and to the two slots at the rear of the waistbelt.

Seat

Wide seat for a comfortable working position while suspended. The width is adjustable, reducing bulk and making it easier to move within the tree. It connects to the two gated points on the SEQUOIA and SEQUOIA SRT arborist sit harnesses, using the two shackles.



Adjustable Attachment Bridge

Adjustable attachment bridge for SEQUOIA and SEQUOIA SRT harnesses allows quick and precise adjustment of the position of progression tools installed on the bridge.



Attachment Bridge

Attachment bridge for connection to the two gated attachment points of the SEQUOIA and SEQUOIA SRT arborist sit harnesses, to optimize lateral mobility.



RING

The RING connection ring can be used to create multiple anchors or be installed directly onto the SEQUOIA and SEQUOIA SRT harnesses' attachment bridges to improve the arborist's lateral mobility.



Shackles

Shackles for connecting a seat.



Rescue Harnesses

Designed for rescuers, these harnesses are lightweight for increased mobility and rapid movement during operations. Having the choice between several different models allows you to choose the best fit for different environments that may be encountered in the field.

- **Comfortable, lightweight design**



Comfortable, lightweight design

The semi-rigid and slim waistbelt and leg loops with 3D foam padding provide the range of FALCON harnesses with an optimal comfort-to-weight ratio to limit bulk.



Compact side attachment points

The textile side attachment points on harnesses in the FALCON range are designed for occasional use and limit bulk and weight.

- **Ergonomic**



Easy to adjust

The FALCON and FALCON ASCENT harnesses feature DOUBLEBACK PLUS self-locking buckles on the waistbelt and FAST LT buckles on the leg loops, making them quick and easy to put on and adjust.

- **Efficiently organize equipment and work tools**



Equipment loops and slots

The range of FALCON harnesses feature equipment loops on the sides and at the rear of the waistbelt. Each harness also has slots designed for the CARITOOl tool holder and the TOOLBAG tool pouch.

- **For working while suspended**



The metal ventral attachment point on the FALCON harness distributes the load between the waistbelt and the leg loops while suspended.

- **For efficiency when ascending a rope**



The two-part ventral attachment point of the FALCON ASCENT harness increases the efficiency of rope ascents when using a CROLL ventral rope clamp.

- **For operations using climbing techniques**



The textile bridge construction of the FALCON MOUNTAIN harness favors progression with climbing techniques and makes it comfortable to walk in.

FALCON harnesses



FALCON

Lightweight sit harness for suspended rescue

FALCON is a lightweight sit harness designed for rescue operations involving suspension. The metal ventral attachment point distributes the load between the waistbelt and leg loops. The design is lightweight and comfortable, joining the slim, semi-rigid waistbelt and leg loops with 3D foam padding. It provides optimal balance between low weight and comfort, as well as reduced bulk, when you're standing, moving, or hanging. The DOUBLEBACK PLUS self-locking buckles on the waistbelt and the FAST LT buckles on the leg loops make it quick and easy to put on and adjust. The rear loop allows a TOP or TOP CROLL L chest harness to be attached.



FALCON ASCENT

Lightweight and comfortable sit harness for rescue operations and work involving rope ascent

FALCON ASCENT is a lightweight sit harness designed for rescue operations and work involving rope ascent. The two-part ventral attachment point fastens with an OMNI carabiner and provides greater efficiency when ascending a rope. The design is lightweight and comfortable, joining the slim, semi-rigid waistbelt and leg loops with 3D foam padding, which provides optimal balance between low weight and comfort, as well as reduced bulk. The DOUBLEBACK PLUS self-locking buckles on the waistbelt and the FAST LT buckles on the leg loops make it quick and easy to put on and adjust. The rear loop allows a TOP CROLL L chest harness to be attached.



FALCON MOUNTAIN

Ultra-lightweight and comfortable sit harness for rescue operations that involve climbing techniques

FALCON MOUNTAIN is an ultra-lightweight sit harness designed for rescue operations that involve climbing techniques. Its ventral attachment point has a textile bridge for mobility when progressing and comfort when walking. The design is very lightweight and comfortable, joining the slim, semi-rigid waistbelt and leg loops with 3D foam padding, which provides an optimal balance between low weight and comfort, as well as reduced bulk. The DOUBLEBACK self-locking buckles on the waistbelt and leg loops make it quick and easy to put on and adjust. The rear plastic loop allows a TOP or TOP CROLL L chest harness to be attached.

Accessories



CHEST'AIR

Chest harness for sit harness

The CHEST'AIR chest harness transforms the FALCON, FALCON MOUNTAIN, AVAO SIT, and SEQUOIA SRT sit harnesses into fall-arrest harnesses. With multiple certifications, CHEST'AIR can be attached to a climbing or mountaineering harness to keep a victim upright during a rescue. It simply connects to the ventral attachment point of the sit harness and fastens via the FAST LT buckle at the chest, for quick donning. It adapts easily to different body types with its DOUBLEBACK PLUS self-locking buckles on the shoulder straps and ventral strap. Made with 3D foam padding, the CHEST'AIR chest harness provides additional comfort while hanging.



Evacuation Triangles and Litter

Evacuation Triangles

Evacuation triangles are mainly used for rescue on cable lifts and by firefighters. They allow unequipped people to be evacuated in minimal time.



THALES

Safety chest collar and comfortable evacuation triangle with shoulder straps

The THALES safety chest collar and evacuation triangle is designed for rescue operations, cable lift evacuations, and helicopter evacuations. The chest collar configuration allows the evacuee to be secured in an emergency and then evacuated with the triangle. Passing from the chest collar configuration to the triangle configuration is quick with the use of three hook and loop straps. The ergonomic shape of the seat and the presence of shoulder straps makes suspension more comfortable than with a classic evacuation triangle. Color-coding differentiates the back and seat, as well as the different straps and closure system, making it easier to put on the evacuee. The high-strength TPU tarp material allows regular to intensive use.



PITAGOR

Comfortable evacuation triangle with shoulder straps

The PITAGOR evacuation triangle is designed for rescue operations and cable lift evacuations. The ergonomic shape of the seat and the presence of shoulder straps makes suspension more comfortable than with a classic evacuation triangle. Color-coding differentiates the back and seat, as well as the closure system, making it easier to put on the evacuee. The high-strength TPU tarp material allows regular to intensive use.

Rescue Litter



STEF

Tilting device for NEST litter

The STEF tilting device joins the three connection points of the NEST litter and allows it to be easily tilted according to the terrain. It has three Am'D TRIACT-LOCK connectors for automatic locking of the connection points, and a swivel for precise orientation of the litter.

NEST

Litter for confined spaces

The NEST litter was developed in partnership with the French national caving rescue organization. It allows a victim to be transported horizontally, vertically, or at an angle. It handles easily and simplifies loading the victim. It is suitable for technical rope rescue, particularly in confined spaces.



Bag for NEST Litter

The bag for the NEST litter allows it to be transported and stored. The openings at either end allow the handles of the litter to protrude, for easier handling. It is equipped with three handles and a bandolier system for easier transport.



RING2RING

Rigid double ring for sit harnesses with textile bridges

Specifically designed to be used on sit harnesses with textile bridges, the RING2RING accessory is primarily for use during helicopter rescue. It functions as a second attachment ring in addition to the textile loop, allowing the rescuer to better organize their equipment at the ventral attachment point and making it easier for the winch operator to access the connection point when connecting the rescuer.



RING2SIDE

Accessory that allows you to convert a textile lateral attachment point into a metal attachment point

The RING2SIDE accessory allows you to convert a textile lateral attachment point into a metal attachment point on the FALCON and FALCON ASCENT harnesses. Its large ring and intuitive clipping orientation makes it easier to attach equipment. It can also be folded down to avoid being snagged when not in use.



LIFT

Spreader for harnesses

Spreader for full-body harnesses or sit harnesses used in conjunction with a chest harness, allowing upright descent (for confined spaces).



Installing and uninstalling the CARITOOl



CARITOOl

Harness tool holder

The CARITOOl tool holder provides one-handed tool access and storage. The stabilizing clip allows it to slip onto the harness straps and stay in place. The gate has a protective feature that limits accidental snagging. It is available in two sizes.



RING OPEN

Multidirectional gated ring



Shackles

Shackles for connecting a seat (pack of 2). Connects to the gated attachment point on a harness, allowing you to efficiently integrate equipment.



Lanyard Connector Parking

Lanyard connector parking accessory (pack of 2)

Lanyard connector parking accessories install on the shoulder straps of VOLT, VOLT WIND, AVAO BOD, AVAO BOD FAST, and ASTRO BOD FAST harnesses and TOP, TOP CROLL S, and TOP CROLL L chest harnesses. They allow the MGO connectors on fall-arrest lanyards to be stowed on each shoulder strap, keeping the connectors within reach and the lanyard out of the user's way. In the event of a fall, the system releases the MGO connectors and allows the absorber to be deployed.



PORTO

Webbing equipment loop

Webbing equipment loop that attaches to a pack's internal loop for organizing equipment.



BOLTBAG

Equipment pouch

Equipment pouch for organizing a hammer, bolting gear, and other equipment. It has two pockets and exterior holster.



Harness Accessories

Petzl offers a complete solution that secures equipment when working at height to help prevent tools from being dropped. These products were designed in accordance to the ANSI/ISEA 121-2018 standard for dropped object prevention solutions.



Petzl Dropped Tool Prevention Solution



INTERFAST

+



TOOLEASH

+



TOOLINK S
& TOOLTAPE

or



TOOLINK M

or



TOOLINK L

- TOOLINK S & TOOLTAPE for tools up to 2.3 kg



- TOOLINK M for tools up to 3 kg



- TOOLINK L for tools up to 5 kg





TOOLBAG

Tool pouch

The TOOLBAG tool pouch allows you to store small tools and fasteners. The opening and closure system is easy to use with one hand. It can be connected to the harness using the INTERFAST accessory, reducing bulk on the harness and making the pouch more accessible. It is durably constructed and can be used on a daily basis without worrying about wear. It is available in three sizes: 1.5, 3, and 6 liters.



INTERFAST

Quick connection accessory for the TOOLBAG and TOOLEASH

INTERFAST is an accessory that allows you to connect a TOOLBAG tool pouch and a TOOLEASH drop-prevention tether. It is versatile and compatible with any harness that has slots. The design is compact and durable to limit bulk on the harness and keep all the attached elements secure when working at height.



TOOLEASH

Extendable drop-prevention tether for tools weighing up to 5 kg

The TOOLEASH extendable tether allows you to attach a tool to prevent dropping it when working at height. The high-strength elasticized tether is compact on your harness. The versatile connection system allows the user to make a long-term tool tether or switch between tools, depending on need. TOOLEASH is part of a complete solution for dropped tool prevention.



x5

TOOLINK S and TOOLTAPE

Attachment for a tool weighing up to 2.3 kg (pack of 5 TOOLINK S tether and a TOOLTAPE adhesive)

TOOLINK S is an attachment that allows you to connect and secure a tool with no connection hole and a smooth, straight handle when working at height. It can be installed on a tool weighing up to 2.3 kg using TOOLTAPE adhesive. The ergonomic connection point allows you to quickly clip and unclip, so it's easy to use.



x5

TOOLINK M

Attachment for a tool weighing up to 3 kg with a connection hole (pack of 5)

TOOLINK M is an attachment that allows you to connect and secure a tool weighing up to 3 kg with an integrated connection hole when working at height. The ergonomic connection point allows you to quickly clip and unclip, so it's easy to use.



x5

TOOLINK L

Attachment for a tool weighing up to 5 kg (pack of 5)

TOOLINK L is an attachment that allows you to connect and secure a heavier tool weighing up to 5 kg when working at height. The ergonomic connection point allows you to quickly clip and unclip, so it's easy to use.









MINO

Non-PPE accessory carabiner

This product is not PPE (Personal Protective Equipment).



General Purpose Harnesses



		European Versions		International Versions		
		References	Certifications	References	Certifications	
Fall-Arrest Harnesses						
NEWTON		NEWTON	C073AA01	CE EN 361 EAC JSFAD	C073BA01	ANSI Z359.11 CSA Z259.10 CE EN 361 EAC JSFAD XF 494 Type III GB 6095
			C073AA02		C073BA02	
		NEWTON FAST	C073CA01		C073DA01 C073IA00 (1)	
			C073CA02		C073DA02 C073IA01 (1)	
		NEWTON EASYFIT	C073EA00		C073FA00	
			C073EA01		C073FA01	
			C073EA02		C073FA02	
HI-VIZ Vest for NEWTON Harnesses		C073GA00	CE EN 20471	-	ANSI 107 CSA Z96	
	C073HA00					
Leg Loop Padding for NEWTON Harnesses		C073JA00	-	-	-	
Fall-Arrest and Work-Positioning Harnesses						
VOLT		VOLT	C072AA00	CE EN 361 EN 358 EN 813 EAC JSFAD	C072CA00	ANSI Z359.11 CSA Z259.10 CE EN 361, EN 358 JSFAD
			C072AA01		C072CA01	
			C072AA02		C072CA02	
		VOLT WIND	C072BA00		C072DA00	
			C072BA01		C072DA01	
			C072BA02		C072DA02	
Seat for VOLT Harnesses			C072EA00	CE EN 358 (3)	-	ANSI Z359.11 (6) CSA Z259.10 (6)
Harnesses for Fall Arrest, Work Positioning, and Suspension						
NEW2025 AVAO		AVAO	C071AB00	CE EN 361 EN 358 EN 813	C071CB00	ANSI Z359.11 ANSI Z459.1 NFPA 1983 class III CSA Z259.10 CE EN 361, EN 358, EN 813 GB 6095: Q-W-Z
			C071AB01		C071CB01	
			C071AB02		C071CB02	
		AVAO FAST	C071BB00 C071BB03 (1)		C071DB00 C071DB03 (1)	
			C071BB01 C071BB04 (1) C071BB02 C071BB05 (1)		C071DB01 C071DB04 (1) C071DB02 C071DB05 (1)	
NEW2025 TOP		C081AB00 C081AB01 (1)	CE EN 361 (2)	C081EA00 (TOP JP)	CE EN 361 (2) JSFAD (2)	
NEW2025 AVAO SIT		AVAO SIT	C079AB00 C079AB02 (1)	CE EN 358 EN 813 JSFAD	-	-
			C079AB01 C079AB03 (1)			
		AVAO SIT FAST	C079BB00	CE EN 358 EN 813		
			C079BB01 C079BB02			
NEW2025 PODIUM		S071AB00	-	-	-	
NEW2025 PODIUM Covering		S071CA00	-	-	-	
NEW2025 LITEPOD		S071BA00	-	-	-	
NEW2025 LITEPOD Covering		S071DA00	-	-	-	

	Attachment Points				Sizes				Weight	
	Dorsal	Sternal	Ventral	Side	Sizes	Waistbelt	Leg Loops	Height		
● ● - -	● ● - -	● ● - -	- -	- -	1	70 - 93 cm	47 - 62 cm	165 - 185 cm	900 g 1125 g (4)	
					2	83 - 120 cm	50 - 65 cm	175 - 200 cm	900 g 1155 g (4)	
	● ● - -	● ● - -	- -	- -	- -	1	70 - 93 cm	47 - 62 cm	165 - 185 cm	1010 g 1355 g (4)
						2	83 - 120 cm	50 - 65 cm	175 - 200 cm	1050 g 1395 g (4)
	● ● - -	● ● - -	- -	- -	- -	0	65 - 80 cm	44 - 59 cm	160 - 180 cm	1310 g 1655 g (4)
						1	70 - 93 cm	47 - 62 cm	165 - 185 cm	1370 g 1715 g (4)
2						83 - 120 cm	50 - 65 cm	175 - 200 cm	1420 g 1765 g (4)	
- - - -	- - - -	- - - -	- - - -	- - - -	- - - -	- - - -	- - - -	- - - -	380 g	
- - - -	- - - -	- - - -	- - - -	- - - -	- - - -	- - - -	- - - -	- - - -	- - - -	70 g
● ● ● (5) ●	● ● ● (5) ●	● ● ● (5) ●	● (5)	●	0	65 - 80 cm	44 - 59 cm	160 - 180 cm	2100 g 2300 g (4)	
					1	70 - 93 cm	47 - 62 cm	165 - 185 cm	2150 g 2350 g (4)	
					2	83 - 120 cm	50 - 65 cm	175 - 200 cm	2230 g 2430 g (4)	
	● ● ● (5) ●	● ● ● (5) ●	● ● ● (5) ●	● (5)	●	0	65 - 80 cm	44 - 59 cm	160 - 180 cm	2150 g 2350 g (4)
						1	70 - 93 cm	47 - 62 cm	165 - 185 cm	2200 g 2400 g (4)
						2	83 - 120 cm	50 - 65 cm	175 - 200 cm	2280 g 2480 g (4)
- - - -	- - - -	- - - -	- - - -	- - - -	- - - -	- - - -	- - - -	- - - -	1050 g	
● ● ● ●	● ● ● ●	● ● ● ●	● ●	● ●	0	65 - 80 cm	44 - 59 cm	160 - 180 cm	1720 g 1935 g (4)	
					1	70 - 93 cm	47 - 62 cm	165 - 185 cm	1760 g 1965 g (4)	
					2	83 - 120 cm	50 - 65 cm	175 - 200 cm	1860 g 2075 g (4)	
	● ● ● ●	● ● ● ●	● ● ● ●	● ●	● ●	0	65 - 80 cm	44 - 59 cm	160 - 180 cm	1695 g 2060 g (4)
						1	70 - 93 cm	47 - 62 cm	165 - 185 cm	1735 g 2100 g (4)
						2	83 - 120 cm	50 - 65 cm	175 - 200 cm	1835 g 2200 g (4)
- ● - -	- ● - -	- - - -	- - - -	- - - -	- - - -	- - - -	- - - -	- - - -	160 - 200 cm	465 g
- - ● ●	- - ● ●	- - ● ●	● ●	● ●	1	70 - 93 cm	47 - 62 cm	165 - 185 cm	1100 g	
					2	83 - 120 cm	50 - 65 cm	175 - 200 cm	1200 g	
	- - ● ●	- - ● ●	- - ● ●	● ●	● ●	0	65 - 80 cm	44 - 59 cm	160 - 180 cm	1035 g
						1	70 - 93 cm	47 - 62 cm	165 - 185 cm	1075 g
						2	83 - 120 cm	50 - 65 cm	175 - 200 cm	1175 g
- - - -	- - - -	- - - -	- - - -	- - - -	- - - -	- - - -	- - - -	- - - -	- - - -	1150 g
- - - -	- - - -	- - - -	- - - -	- - - -	- - - -	- - - -	- - - -	- - - -	- - - -	440 g
- - - -	- - - -	- - - -	- - - -	- - - -	- - - -	- - - -	- - - -	- - - -	- - - -	770 g
- - - -	- - - -	- - - -	- - - -	- - - -	- - - -	- - - -	- - - -	- - - -	- - - -	310 g

(1) Black harness, (2) with AVAO SIT, FALCON, FALCON MOUNTAIN, SEQUOIA SRT sit harnesses, (3) with VOLT harnesses, (4) weight of international version, (5) on European versions, (6) depending on the VOLT harness used.



Specialized Harnesses

		European Versions		International Versions		
		References	Certifications	References	Certifications	
Rope Access Harnesses						
 NEW2025 ASTRO		C083AB00	CE EN 361 EN 358 EN 813 EN 12841 type B	C083BB00 C083BB03 (1)	ANSI Z359.11, ANSI Z459.1 NFPA 2500 class III CSA Z259.10 CE EN 361, EN 358, EN 813, EN 12841 type B JSFAD XF 494, GB 6095	
		C083AB01				C083BB01 C083BB04 (1)
		C083AB02				C083BB02 C083BB05 (1)
 NEW2025 TOP CROLL		C081CB00	CE EN 361 (2) EN 12841 type B (2)	C081DA00 (TOP CROLL JP)	CE EN 361 (2) EN 12841 type B (2) JSFAD (2)	
 NEW2025 ASTRO SIT		C085AB00	CE EN 358, EN 813	-	-	
		C085AB01				
		C085AB02				
NEW2025 PODIUM		S071AB00	-	-	-	
NEW2025 PODIUM Covering		S071CA00	-	-	-	
NEW2025 LITEPOD		S071BA00	-	-	-	
NEW2025 LITEPOD Covering		S071DA00	-	-	-	

Tree Care Harnesses						
 SEQUOIA	SEQUOIA SRT	C069BA00	CE EN 358, EN 813 EAC	-	-	
		C069BA01			-	
		C069BA02			-	
	SEQUOIA	C069AA00			-	GB 6095
		C069AA01			-	
		C069AA02			-	
Shoulder Straps		C069DA00	-	-	-	
Seat		S069AA00	-	-	-	
Adjustable attachment bridge		C69R	-	-	-	
Attachment bridge	40 cm	C069CA00	-	-	-	
	45 cm	C069CA01	-	-	-	
	50 cm	C069CA02	-	-	-	

Rescue Harnesses					
 FALCON	FALCON	C038DA02 (1)	CE EN 813, EN 358 EAC ASTM F1772	-	-
		C038DA00 / C038DA03 (1)			-
		C038DA01 / C038DA04 (1)			-
	FALCON ASCENT	C038EA00	CE EN 813, EN 358 EAC ASTM F1772	-	-
		C038EA01			-
	FALCON MOUNTAIN	C038FA00	CE EN 813, EN 358 EN 12277 type C EAC, ASTM F1772	-	-
C038FA01				-	
CHEST'AIR		C098AA00	CE EN 361 (3), EN 12277 type D EAC	-	-

Evacuation Triangles and Litter					
THALES		C061AA00	CE EN 1497, EN 1498 types A & B, EASA CM-CS-005	-	-
PITAGOR		C060AA00	CE EN 1497 EN 1498 type B EASA CM-CS-005	-	-
NEST		S061AA00	CE	-	-
STEF		S059AA00 / S059BA00 (5)	CE	-	-
Bag for NEST Litter		S062AA00	-	-	-

		References	Certifications	Colors	Weight
Harness Accessories					
RING2RING		C030AA00	CE EN 362 type M, EN 12275 type Q, EAC	-	100 g
RING2SIDE		C030BA00	CE EN 362 type M, EAC	-	75 g
LIFT		L54	CE	-	520 g
CARITool S		P042AA00	-	-	35 g
CARITool L		P042AA01			75 g
RING OPEN		P28, M028AA00	CE EN 362	-	70 g
Shackles		C087AA00	-	-	20 g
Lanyard Connector Parking		C088AA00	-	Yellow	45 g
		C088AA01		Black	
PORTO		C33	-	-	18 g
BOLTBAG		C11 A	-	-	170 g

	Attachment Points				Sizes				Weight
	Dorsal	Sternal	Ventral	Side	Sizes	Waistbelt	Leg Loops	Height	
	•	•	•	•	0	65 - 80 cm	44 - 59 cm	160 - 180 cm	1930 g / 2415 g (4)
	•	•	•	•	1	70 - 93 cm	47 - 62 cm	165 - 185 cm	1935 g / 2445 g (4)
	•	•	•	•	2	83 - 120 cm	50 - 65 cm	175 - 200 cm	2060 g / 2580 g (4)
	-	•	-	-	-	-	-	160 - 200 cm	525 g / 660 g (JP)
	-	-	•	•	0	65 - 80 cm	44 - 59 cm	-	1145 g
	-	-	•	•	1	70 - 93 cm	47 - 62 cm	-	1170 g
	-	-	•	•	2	83 - 120 cm	50 - 65 cm	-	1265 g
	-	-	-	-	-	-	-	-	1150 g
	-	-	-	-	-	-	-	-	440 g
	-	-	-	-	-	-	-	-	770 g
	-	-	-	-	-	-	-	-	310 g
	-	-	•	•	0	65 - 80 cm	44 - 59 cm	-	1580 g
	-	-	•	•	1	70 - 93 cm	47 - 62 cm	-	1630 g
	-	-	•	•	2	83 - 120 cm	50 - 65 cm	-	1700 g
	-	-	-	•	0	65 - 80 cm	44 - 59 cm	-	1480 g
	-	-	-	•	1	70 - 93 cm	47 - 62 cm	-	1530 g
	-	-	-	•	2	83 - 120 cm	50 - 65 cm	-	1600 g
	-	-	-	-	-	-	-	-	190 g
	-	-	-	-	-	-	-	-	920 g
	-	-	-	-	-	-	-	-	220 g
	-	-	-	-	S	-	-	-	65 g
	-	-	-	-	M	-	-	-	70 g
	-	-	-	-	L	-	-	-	75 g
	-	-	•	•	0	65 - 80 cm	44 - 59 cm	-	900 g
	-	-	•	•	1	70 - 93 cm	47 - 62 cm	-	915 g
	-	-	•	•	2	83 - 120 cm	50 - 65 cm	-	945 g
	-	-	•	•	1	70 - 93 cm	47 - 62 cm	-	800 g
	-	-	•	•	2	83 - 120 cm	50 - 65 cm	-	830 g
	-	-	•	•	1	70 - 93 cm	47 - 62 cm	-	670 g
	-	-	•	•	2	83 - 120 cm	50 - 65 cm	-	700 g
	-	•	-	-	-	-	-	-	525 g
	-	-	-	-	-	-	-	-	1315 g
	-	-	-	-	-	-	-	-	1300 g
	-	-	-	-	-	-	-	-	13,1 kg
	-	-	-	-	-	-	-	-	640 g / 620 g (5)
	-	-	-	-	-	-	-	-	1860 g

References	Certifications	Volume	Weight
Harness Accessories (continued)			
TOOLBAG 1.5	S047BA00	1,5 l	100 g
TOOLBAG 3	S047BA01	3 l	140 g
TOOLBAG 6	S047BA02	6 l	245 g
INTERFAST	S051AA00	-	55 g
TOOLEASH	S049AA00	-	56 g
TOOLINK S & TOOLTAPE	S050AA00	-	8 g
TOOLINK M	S050BA00	-	11 g
TOOLINK L	S050CA00	-	16 g

(1) Black harness, (2) when combined with ASTRO SIT FAST, AVAO SIT, AVAO SIT FAST, FALCON, FALCON ASCENT, or SEQUOIA SRT harnesses, (3) when combined with the FALCON, FALCON MOUNTAIN, AVAO SIT, AVAO SIT FAST, or SEQUOIA SRT sit harnesses into fall-arrest harnesses, (4) international version, (5) for NEST litter before 2020.



LANYARDS AND ENERGY ABSORBERS

Whether for work positioning or to have an energy absorber that limits the force transmitted to the user in the event of a fall, Petzl offers a complete line of lanyards for different applications.



Communication tower maintenance, France © 2024 Petzl Distribution – Vuedici.org – Green Up – TDF

Depending on the model, the ends of Petzl lanyards are equipped with plastic sheaths or with a STRING. These items help keep the connector positioned on the major axis and make it easier to clip. They also protect the ends from abrasion due to repeated rubbing.



Plastic sheath



STRING

General Purpose Lanyards

Work-Positioning Lanyards

Adjustable lanyards with ergonomic handle allow comfortable positioning at a workstation.



Fall-Arrest Lanyards

Lanyards with an energy absorber, used when there is a fall hazard.

Petzl offers three types of lanyards with an absorber:

- Single (ABSORBICA-I) or double (ABSORBICA-Y) lanyards with an energy absorber
- Lanyards that can be combined with an ABSORBICA energy absorber to create a single or double energy-absorbing lanyard with a maximum length of two meters



Specialized Lanyards

Progression Lanyards for Rope Access

Fixed or adjustable lanyards, for many different types of progression. Available in single and double versions.



Positioning Lanyard for Rope Access

Adjustable lanyard with rope adjuster, for positioning at a workstation.

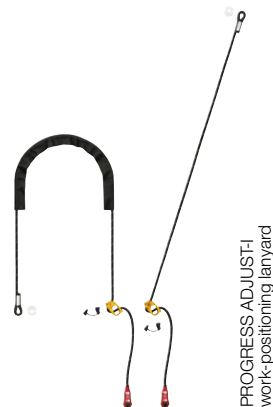

Tree Care Lanyards

Adjustable positioning lanyards that allow comfortable positioning for tree care work.



Helivac Lanyards

Lanyards for helicopter drop-off and recovery.



Work-Positioning Lanyards

Positioning lanyards allow the user to position themselves precisely at a workstation, with feet supported on the structure. They can adapt to different anchoring configurations.

• Versatile

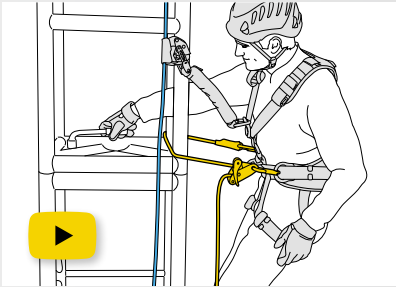

Double mode use

The GRILLON lanyard can be used in double mode (on the harness side attachment points) when the user works with weight on their feet. This type of attachment provides better load distribution on the belt. The user precisely adjusts their position by pressing on the lanyard's pivoting cam.

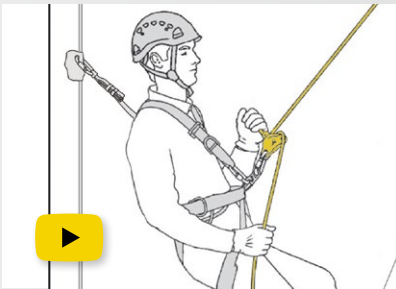

Single mode use

When the anchor is located above the user, the GRILLON lanyard is connected to the harness ventral attachment point, so that the load is comfortably distributed between the waistbelt and leg loops. The user adjusts their position by operating the handle, while holding the free end of the lanyard.

• Easy to handle



Sewn terminations with plastic sheaths

Sewn terminations increase strength (compared to a knotted termination) while reducing bulk. The plastic sheaths protect the stitching from abrasion and facilitate handling by holding the connector in position.

• Differentiation of lanyard lengths

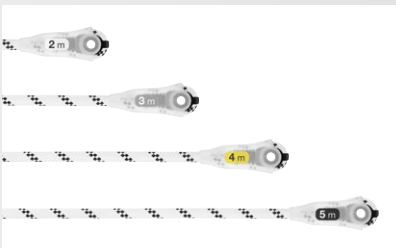

Lanyard length can be immediately identified by a color-coded label at the connector end.

• Petzl Custom for work-positioning lanyards

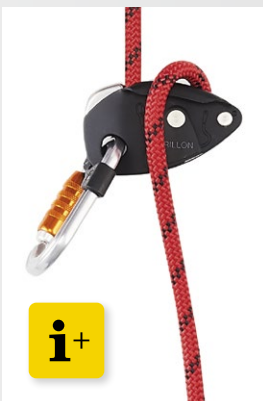

Petzl Custom allows you to choose:

- Lanyard type: Standard or high-strength rope
- Lanyard color
- Lanyard length
- Type of lanyard-end connectors and harness connector

The assembly of various components of your choice offers a ready-made solution specific to the user.

• Without connector



GRILLON lanyards are sold without connectors, so that they can be combined with different connector types, depending on the user's requirements.

• With HOOK connector



GRILLON HOOK lanyards are equipped with a HOOK auto-locking connector, ideal for connections using the harness side attachment points.

• With MGO connector



GRILLON lanyards, in combination with an MGO auto-locking connector, are ideal for connection to metal structures or to large-diameter cables and bars.



GRILLON

Adjustable lanyard for work positioning

The GRILLON adjustable lanyard is used to make work-positioning systems to complement a fall-arrest system. Its length can be very easily and precisely adjusted as necessary for comfortable positioning at the workstation. Depending on the configuration, it can be used in single or double mode. GRILLON is available in seven lengths (2, 3, 4, 5, 10, 15 and 20 m), and also in black. It is certified to North American, European, and Russian standards.



GRILLON PLUS

Adjustable work-positioning lanyard with high abrasion resistance

The GRILLON PLUS lanyard is used to make work-positioning systems, to complement a fall-arrest system. Its length can be very easily and precisely adjusted as necessary for comfortable positioning at the workstation. The aramid fiber rope provides excellent abrasion resistance. Depending on the configuration, it can be used in single or double mode. GRILLON PLUS is available in two lengths: 2 and 3 m, and is certified to North American, European, and Russian standards.



GRILLON HOOK European Version

Adjustable work-positioning lanyard with HOOK connector

The GRILLON HOOK adjustable lanyard is used to make work-positioning systems to complement a fall-arrest system. Its length can be very easily and precisely adjusted as necessary for comfortable positioning at the workstation. Its HOOK connector is ideal for using the lanyard in double mode on the harness side attachment points. The GRILLON HOOK (European version) is available in four lengths (2, 3, 4 and 5 m) and is certified to European and Russian standards.



GRILLON HOOK International Version

Adjustable work-positioning lanyard with HOOK connector

The GRILLON HOOK adjustable lanyard is used to make work-positioning systems to complement a fall-arrest system. Its length can be very easily and precisely adjusted as necessary for comfortable positioning at the workstation. Its HOOK connector is ideal for using the lanyard in double mode on the harness side attachment points. GRILLON HOOK (international version) is available in four lengths (2, 3, 4 and 5 m) and is certified to North American and European standards.



GRILLON MGO

Adjustable work-positioning lanyard with MGO connector

The GRILLON MGO lanyard is used to make work-positioning systems to complement a fall-arrest system. Its length can be very easily and precisely adjusted as necessary for comfortable positioning at the workstation. Connector with large gate opening is ideal for connection to metal structures or to large-diameter cables and bars. GRILLON MGO is available in two lengths: 2 and 3 m, and is certified to North American and European standards.



Fall-Arrest Lanyards

These lanyards are used when there is a fall hazard and they are connected to the sternal or dorsal attachment point on the harness. The integrated absorber provides energy absorption in a fall, limiting the impact force on the user.

- **Energy absorption for users who weigh between 60 and 140 kg**

In the event of a fall, the progressive tearing of the energy absorber webbing limits the impact force on the user. The lanyards are designed for users who weigh between 60 and 140 kg.

- **Compact and abrasion resistant energy absorber**



The energy absorbers are very compact to avoid hindering the user's movements or interfering with work. The durable fabric pouch helps protect the energy absorber from abrasion and potential contaminants.

- **Ready-to-use or customizable lanyards**



Ready-to-Use Lanyards

ABSORBICA-Y MGO and ABSORBICA-Y TIE-BACK MGO lanyards come with lanyard-end connectors, as well as connectors for harness attachment.

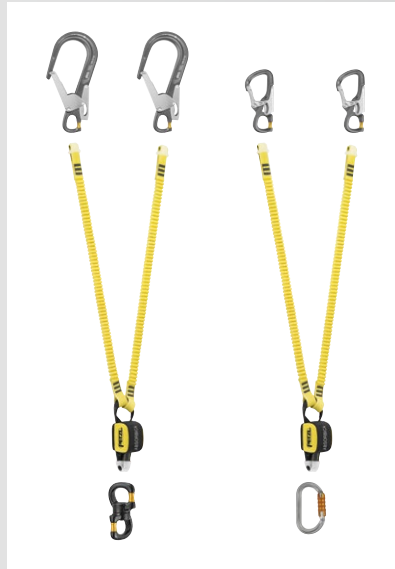

Customizable Lanyards

ABSORBICA-I (80, 150, and VARIO) and ABSORBICA-Y (80, 150, and TIE-BACK) lanyards do not come with connectors, allowing the user to customize the lanyard according to their needs and the structure they're working on.

Note: Certifications depend on the connectors that are used.

- **For progression on a lifeline without passing intermediate anchors**

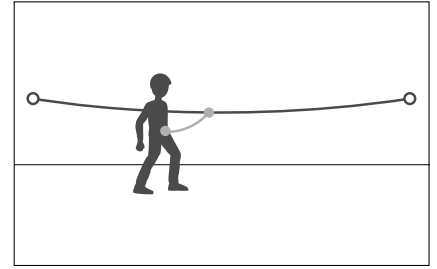

ABSORBICA-I single lanyards are designed especially for protection on a horizontal lifeline or on an elevated platform.

- **For progression on a vertical structure or a lifeline and when passing intermediate anchors**

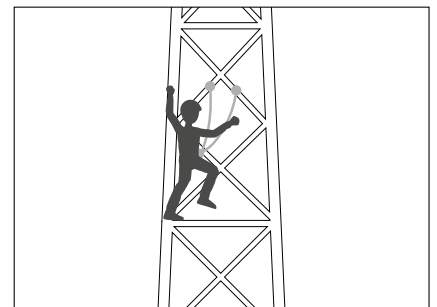
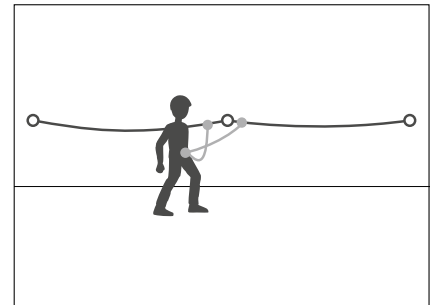

The ABSORBICA-Y lanyards with two arms allow for continuous protection by successively detaching and re-attaching the two arms.



ABSORBICA-I lanyards



ABSORBICA®-I 80/150

Single lanyard with integrated energy absorber

ABSORBICA-I is a single lanyard with compact energy absorber, designed for progression on a horizontal lifeline (rope or cable) or on an elevated platform, without passing intermediate anchors. It works with users who weigh between 60 and 140 kg. It has several connection options on the harness and can be used with different types of connectors. Available in two versions: 80 (rope arm) or 150 FLEX (elasticized arm).

ABSORBICA®-I VARIO

Adjustable single lanyard with integrated energy absorber

ABSORBICA-I VARIO is an adjustable single lanyard with compact energy absorber designed for progression on a horizontal lifeline (rope or cable) or on an elevated platform, without passing intermediate anchors. It works with users who weigh between 60 and 140 kg. It features the VARIO adjustment system, allowing the lanyard length to be adjusted in order to reduce potential fall height.



ABSORBICA-Y lanyards



ABSORBICA®-Y 80/150

Double lanyard with integrated energy absorber

ABSORBICA-Y is a double lanyard with compact energy absorber, designed for progression on a vertical structure or a horizontal lifeline, and for passing intermediate anchors. It works with users who weigh between 60 and 140 kg. It has several connection options on the harness and can be used with different types of connectors. Available in two versions: 80 (rope arms) or 150 FLEX (elasticized arms).

ABSORBICA®-Y MGO 80/150 European Version

Double lanyard with integrated energy absorber and MGO connectors

ABSORBICA-Y MGO is a double lanyard with compact energy absorber, designed for progression on a vertical structure or a horizontal lifeline, and when passing intermediate anchors. It works with users who weigh between 60 and 140 kg. It's ready to use, with two large-opening MGO connectors on the end of the lanyard and an OK TRIACT-LOCK connector for harness attachment. It is available in two versions: 80 (rope arms), or 150 FLEX (elasticized arms).

ABSORBICA®-Y MGO 80/150 International Version

Double lanyard with integrated energy absorber and MGO connectors

ABSORBICA-Y MGO is a double lanyard with compact energy absorber, designed for progression on a vertical structure or a horizontal lifeline, and when passing intermediate anchors. It works with users who weigh between 60 and 140 kg. It's ready to use, with two large-opening MGO connectors on the end of the lanyard and a Bm'D connector for harness attachment. It is available in two versions: 80 (rope arms), or 150 FLEX (elasticized arms).

ABSORBICA®-Y TIE-BACK/MGO

Double lanyard with integrated intermediate tie-back rings and energy absorber

The ABSORBICA-Y TIE-BACK is a double lanyard with integrated intermediate tie-back rings and compact energy absorber. It is designed for vertical progression on very large structures and passing intermediate anchor points. It works with users who weigh between 60 and 140 kg. The TIE-BACK system allows the user to wrap structures with very large cross sections. The arms are elasticized to avoid hindering progression. It's available in two versions: without connectors, or with large-opening MGO connectors on the lanyard ends and a Bm'D connector for harness attachment.



Fall-Arrest Lanyards

Fall-Arrest Lanyards



JANE-I

Single lanyard for making a fall-arrest lanyard

JANE-I is a non-adjustable dynamic rope lanyard that can be combined with an ABSORBICA energy absorber to make a single lanyard with energy absorber. The plastic sheath helps hold the carabiner in position and facilitates clipping while protecting the termination from abrasion. It can be used to set up a temporary anchor. It is available in three lengths: 60, 100, and 150 cm.



JANE-Y for Fall-Arrest Lanyard

Double lanyard for making a fall-arrest lanyard

JANE-Y for fall-arrest lanyard is a non-adjustable dynamic rope lanyard that can be combined with an ABSORBICA energy absorber to make a double lanyard with energy absorber. The plastic sheaths help hold the carabiners in position and facilitate clipping while protecting the terminations from abrasion. It has two symmetrical ends and is available in two lengths: 60 and 100 cm.



RING OPEN

Multidirectional gated ring



ABSORBICA®

Compact energy absorber

ABSORBICA is an energy absorber designed to be used in combination with a JANE lanyard to make a fall-arrest lanyard. Very compact, it minimizes bulk on the harness. Equipped with tear-webbing inside an openable pouch, the absorber is protected from abrasion while allowing for regular inspection.

Progression Lanyards for Rope Access



PROGRESS ADJUST-Y

Double adjustable progression lanyard

PROGRESS ADJUST-Y is a double adjustable progression lanyard that enables continuous connection for different types of progression (such as rope ascent or moving along a fixed line). Using the ADJUST rope adjuster, the length of the adjustable arm can be quickly and easily adjusted. The TANGA accessory and the plastic sheath help hold the connectors in a good position for easy clipping.



The PROGRESS ADJUST-Y lanyard allows continuous connection during all types of progression (rope ascent, moving along a traverse line...).



It adjusts quickly and precisely with the ADJUST rope adjuster, which releases with a simple turn and handles easily, thanks to its ergonomic shape.



PROGRESS ADJUST-I

Single adjustable progression lanyard

PROGRESS ADJUST-I is a single adjustable progression lanyard that, when combined with another lanyard, allows continuous connection for different types of progression (such as rope ascent or moving along a fixed line). Using the ADJUST rope adjuster, the length can be quickly and easily adjusted. Reversible, the ADJUST rope adjuster can be placed on the anchor or on the harness ventral attachment point. The CAPTIV ADJUST and STUART accessories help hold the connectors in a good position for easy clipping.

JANE-Y

Double progression lanyard

JANE-Y is a double progression lanyard that allows continuous connection during rope ascents. The plastic sheaths help hold the carabiners in position and facilitate clipping while protecting the terminations from abrasion. It has a 60 cm long arm and a 30 cm short arm.

Work-Positioning Lanyard

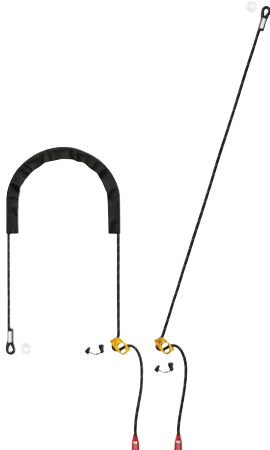

PROGRESS ADJUST-I

Adjustable positioning lanyard

When combined with a fall-arrest device, the PROGRESS ADJUST-I adjustable positioning lanyard enables comfortable positioning at a workstation when the user has support for their feet. Using the ADJUST rope adjuster, the length can be quickly and easily adjusted. The CAPTIV ADJUST and STUART accessories help hold the connectors in a good position for easy clipping. Depending on the configuration, it can be used in single or double mode. The PROGRESS ADJUST-I positioning lanyard is available in three lengths (2, 3, and 5 m).

ZILLON

Adjustable work-positioning lanyard for tree care

The ZILLON work-positioning lanyard for tree care adjusts easily with only one hand, even when loaded. It is designed for use in double mode on the harness side attachment points, or in single mode on the ventral attachment point with the hand on the free end. The yellow color makes it highly visible. ZILLON lanyard ropes are also available individually.

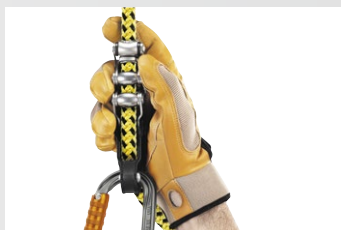

Easy to adjust with one hand, due to the progressive locking/unlocking action of the device.



Pulley mounted on sealed ball bearings allows slack to be taken up easily.



MICROFLIP

Reinforced adjustable positioning lanyard for tree care work

MICROFLIP is a reinforced adjustable lanyard designed for positioning in tree care work. Its cable core reduces the risk of severing the lanyard and facilitates moving about on the trunk. The yellow color makes it highly visible. MICROFLIP lanyard ropes are also available individually.



MICROGRAB

Replacement cam-loaded rope clamp for MICROFLIP

Replacement rope clamp for MICROFLIP, featuring an ergonomic cam and integrated cam spring.

Helivac Lanyards



LEZARD

Helivac lanyard with securing of the drop-off/recovery phases

The LEZARD lanyard is designed for helivac at altitude. It allows the drop-off/recovery phases to be secured due to the adjustable arm that can be instantly ejected to free the victim, the rescuer, and the helicopter if the latter needs to suddenly leave its stationary position. Operating the LEZARD helivac lanyard is easy, with color-coded attachment elements that can be instantly identified and the ADJUST rope adjuster that can quickly and precisely adjust lanyard length.



IGUANE

Helivac lanyard for ground drop-off/recovery

The IGUANE lanyard is designed for ground helivac. Easy to use, with color-coded attachment elements that can be instantly identified. Lanyard available in two lengths.



The lower ends are equipped with STRING, which helps hold the carabiner in position and protects the webbing from wear.

Lanyard-End Connectors

NEW
2025



VERTIGO TWIST-LOCK

Connector for progression lanyard



EASHOOK OPEN

Connector with gated connection point for double lanyard and work-positioning lanyard



MGO OPEN

Auto-locking directional connector with large gate opening and a gated connection point



		Connectors	Lengths	Certifications	Weight
Work-Positioning Lanyards and Lanyards for Rope Access or Tree Care					
GRILLON	L052AA00	-	2 m	CE EN 358 EN 12841 type C ANSI Z359.3 CSA Z259.11 EAC GB 24543 GB 30862 Type B GB 38454	480 g
	L052AA01		3 m		560 g
	L052AA02		4 m		640 g
	L052AA03		5 m		720 g
	L052AA04		10 m		1075 g
	L052AA05		15 m		1475 g
	L052AA06		20 m		1875 g
	L052AA07 (black)		2 m		480 g
	L052AA08 (black)		3 m		560 g
GRILLON PLUS	L052EA00	-	2 m		435 g
	L052EA01		3 m		515 g
GRILLON HOOK European Version	L052BA00	HOOK	2 m	CE EN 358 EN 12841 type C EAC	635 g
	L052BA01		3 m		715 g
	L052BA02		4 m		795 g
	L052BA03		5 m		875 g
GRILLON HOOK International Version	L052CA00	HOOK	2 m	CE EN 358 EN 12841 type C ANSI Z359.3 CSA Z259.11 EAC GB 24543 GB 30862 Type B GB 38454	770 g
	L052CA01		3 m		850 g
	L052CA02		4 m		930 g
	L052CA03		5 m		1010 g
GRILLON MGO	L052DA00	MGO 60	2 m		1220 g
	L052DA01		3 m		1300 g
Fall-Arrest Lanyards					
ABSORBICA-I 80	L011AB00	-	70 cm	CE EN 355 (1)	170 g
ABSORBICA-I 150	L013AB01	-	153 cm	CE EN 355 ANSI Z359.13, CSA Z259.11-17 JSFAD GB/T 24538-2009: type II (1)	225 g
ABSORBICA-I VARIO	L016AB00	-	70 - 167 cm	CE EN 355 ANSI Z359.13, CSA Z259.11-17 JSFAD GB/T 24538-2009: type II (1)	495 g
ABSORBICA-Y 80	L012AB00	-	70 cm	CE EN 355 (1)	240 g
ABSORBICA-Y 150	L014AB01	-	153 cm	CE EN 355 ANSI Z359.13 CSA Z259.11-17 JSFAD GB/T 24538-2009: type II (1)	275 g
ABSORBICA-Y 80 MGO European Version	L012CB00	MGO x 2 OK TRIACT-LOCK	100 cm	CE EN 355 (1)	1260 g
ABSORBICA-Y 150 MGO European Version	L014CB01		183 cm		1250 g
ABSORBICA-Y 80 MGO International Version	L012BB00	MGO x 2 Bm'D	100 cm	CE EN 355 ANSI Z359.13 JSFAD GB/T 24538-2009: type II (1)	1730 g
ABSORBICA-Y 150 MGO International Version	L014BB01		183 cm		1690 g
ABSORBICA-Y TIE-BACK	L015AB00	-	153 cm	CE EN 355 ANSI Z359.13 CSA Z259.11-17 JSFAD GB/T 24538-2009: type II (1)	400 g
ABSORBICA-Y TIE-BACK MGO	L015BB00	MGO x 2 Bm'D	183 cm		1780 g

		Connectors	Lengths	Certifications	Weight
Fall-Arrest Lanyards					
JANE-I	L050BA00		60 cm	CE EN 354 EN 795 type B ANSI Z359.3 CSA Z259.11 EAC GB 30862 Type B	100 g
	L050BA01	-	100 cm		120 g
	L050BA02		150 cm		145 g
JANE-Y for fall-arrest lanyard	L051AA02	-	60 cm	CE EN 354 ANSI Z359.3	145 g
	L051AA01		100 cm		185 g
ABSORBICA	L010AB00	-	14 cm	CE EN 355	115 g
Progression Lanyards for Rope Access					
PROGRESS ADJUST-Y	L044AA00	-	1 fixed arm, 65 cm 1 arm adjustable up to 95 cm	CE EN 358 EAC GB 24543	230 g
PROGRESS ADJUST-I progression lanyard	L044BA00	-	1 arm adjustable up to 1 m	CE EN 358 ANSI Z359.3 CSA Z259.11 EAC GB 24543 GB 30862 Type B	185 g
JANE-Y	L051AA00	-	1 arm, 60 cm 1 arm, 30 cm	CE EN 354 ANSI Z359.3 EAC	130 g
Work-Positioning Lanyard					
PROGRESS ADJUST-I work-positioning lanyard	L044BA01		1 arm adjustable up to 2 m	CE EN 358 ANSI Z359.3 CSA Z259.11 EAC GB 24543 GB 30862 Type B	300 g
	L044BA02	-	1 arm adjustable up to 3 m		370 g
	L044BA03		1 arm adjustable up to 5 m		510 g
Tree Care Lanyards					
ZILLON	L22A 025		Adjustable to 2.5 m	CE EN 358	570 g
	L22A 040	-	Adjustable to 4 m		735 g
	L22A 055		Adjustable to 5.5 m		900 g
MICROFLIP	L33 025		Adjustable to 2.5 m	CE EN 358 EAC	750 g
	L33 040	-	Adjustable to 4 m		1055 g
	L33 055		Adjustable to 5.5 m		1355 g
MICROGRAB	B53A	-	-	CE EN 358 (2) EN 567 NFPA 2500 Technical Use EAC	150 g
Helivac Lanyards					
LEZARD	L01	3 x VERTIGO TWIST-LOCK 1 x VERTIGO WIRE-LOCK	2 x 35 cm fixed arms 1 ejectable arm, adjustable up to 95 cm	CE	880 g
IGUANE	L001AA00	2 x VERTIGO TWIST-LOCK	2 x 25 cm fixed arms	CE EN 354	390 g
	L001AA01	1 x Am'D TWIST-LOCK	2 x 35 cm fixed arms		395 g

(1) Certifications depend on the connectors that are used, more information provided in the Instructions for Use, (2) with MICROFLIP



MOBILE FALL ARRESTERS

Installed on a lifeline, mobile fall arresters follow the user automatically as they move, whether on an inclined or vertical surface. In the event of a shock load or sudden acceleration, they lock onto the rope and stop the fall.



Mobile Fall Arresters

Installed on a lifeline, mobile fall arresters will lock in the event of a shock load or sudden acceleration.

• For fall protection

Mobile fall arrester that can be combined (or not) with an ASAP'SORBBER or ASAP'SORBBER AXESS energy absorber.



ASAP

• For fall protection, with locking function

Mobile fall arrester with locking function, used with an ASAP'SORBBER or ASAP'SORBBER AXESS energy absorber.



ASAP LOCK

Absorbers for Mobile Fall Arresters

These energy absorbers are for use only with an ASAP or ASAP LOCK mobile fall arrester. They limit the impact force transmitted to the user in the event of a fall.



ASAP'SORBBER



ASAP'SORBBER AXESS

Ropes for Mobile Fall Arresters

Ropes with sewn terminations for use with ASAP and ASAP LOCK mobile fall arresters.



ASAP/AXIS 11 mm



AXIS 11 mm
with sewn termination



RAY 11 mm
with sewn termination



Mobile Fall Arresters

Installed on the primary or secondary rope, the ASAP and ASAP LOCK mobile fall arresters connect to the harness fall-arrest attachment point. They follow the user in their movements, and in the event of a slip, sudden acceleration, or uncontrolled descent, the devices lock and stop the fall.

• Quick installation



The ASAP and ASAP LOCK mobile fall arresters are easy to install anywhere on the rope.

• Free movement along the rope

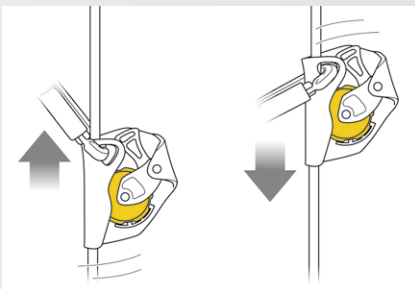

The mobile fall arresters follow the worker in their movements along the rope at a normal speed, without the need for manual operation.

• Integrated locking



In the event of a fall, slip, or uncontrolled descent, the blocking system activates and stops the fall.

• Use in a fall-arrest system

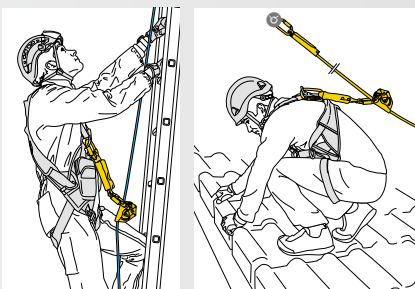

In a fall-arrest system, the worker moves about on the structure. The ASAP or ASAP LOCK mobile fall arrester is installed on a lifeline.

• Use in a rope access system

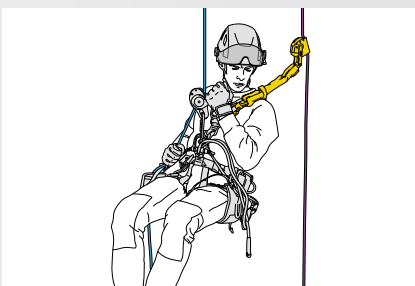

In a rope access system, the worker moves along a work rope. The ASAP LOCK or ASAP mobile fall arrester is installed on a backup rope. Its role is to arrest the fall in case the primary rope fails.

• For fall protection

Depending on the use, the ASAP mobile fall arrester can be combined (or not) with an ASAP'SORBBER energy absorber.

• For fall protection, with locking function

The ASAP LOCK has a locking function allowing users to reduce the potential fall distance. Additionally, it is drop resistant when passing intermediate anchors. It is used with an ASAP'SORBBER energy absorber.



ASAP®

Mobile fall arrester for rope

With its unique locking system, the ASAP sets the standard in fall protection for workers at height. In normal use, the device moves freely along the rope without any manual intervention and follows the user in all their movements. In the event of a shock load or sudden acceleration, the ASAP locks on the rope and stops the user. Depending on the intended use, the ASAP may also be combined with an ASAP'SORBBER or ASAP'SORBBER AXESS energy absorber to work at a distance from the rope.



ASAP® LOCK

Mobile fall arrester for rope, with locking function

The ASAP LOCK mobile fall arrester is designed to facilitate handling during rope ascents. In normal use, the device moves freely along the rope without any manual intervention and follows the user in all their movements. In the event of a shock load or sudden acceleration, the fall arrester locks on the rope and stops the user. The integrated locking function allows the user to immobilize the device in order to reduce the potential fall distance. The connection arm makes the system drop resistant when passing intermediate anchors. The ASAP LOCK is used with an ASAP'SORBBER or ASAP'SORBBER AXESS energy absorber to work at a distance from the rope.



How to install the ASAP and ASAP LOCK on a lifeline



Mobile Fall Arresters

Absorbers for Mobile Fall Arresters



ASAP'SORBER

Energy absorber for ASAP and ASAP LOCK

The ASAP'SORBER energy absorber may only be used with an ASAP or ASAP LOCK mobile fall arrester. It allows the user to work at a distance from the rope, in order to protect it during certain work phases. Equipped with tear-webbing inside a pouch that opens on each end, the absorber is protected from abrasion, while allowing for regular inspection. It is available in two lengths to provide the best balance between distance from the rope and reduced fall distance.



ASAP'SORBER AXESS

Energy absorber for an ASAP or ASAP LOCK for a maximum load of 250 kg

The ASAP'SORBER AXESS energy absorber may only be used with the ASAP or ASAP LOCK mobile fall arrester. It allows the user to work at a distance from the rope, in order to protect it during certain work phases. Equipped with tear-webbing inside a pouch that opens on each end, the absorber is protected from abrasion, while allowing for regular inspection. It can be used in two-person rescue situations for a maximum load of 250 kg.

Ropes for Mobile Fall Arresters



ASAP'AXIS 11 mm

Low stretch kernmantle rope with sewn termination and integrated energy dissipater, for use with an ASAP mobile fall arrester

The ASAP'AXIS 11 mm low stretch kernmantle rope with sewn termination and integrated energy dissipater is designed for use with an ASAP mobile fall arrester. The energy dissipater is integrated with the rope and meets the requirements of the European EN 353-2 standard for fall protection. The standard diameter provides a good grip for easier handling. EverFlex technology provides great flexibility and consistent performance over time. The sewn termination features the STUART accessory that helps keep the connector in position to facilitate handling. Rope available in six lengths.



AXIS 11 mm With Sewn Termination

Low stretch kernmantle rope with sewn termination for use with an ASAP LOCK mobile fall arrester

The AXIS 11 mm low stretch kernmantle rope with sewn termination is designed for use with an ASAP LOCK mobile fall arrester and an ASAP'SORBER or ASAP'SORBER AXESS energy absorber. It has a sewn termination with a protective sheath that helps keep the connector in position, allowing it to meet the requirements of the European EN 353-2 standard for fall protection. The standard diameter provides a good grip for easier handling. EverFlex technology provides great flexibility and consistent performance over time. Rope available in six lengths.





RAY 11 mm With Sewn Termination

(only available in the United States)



Static rope with sewn termination for use with ASAP and ASAP LOCK mobile fall arresters

The RAY 11 mm static rope with sewn termination is designed for use with an ASAP or ASAP LOCK mobile fall arrester. It has low elongation under load, allowing it to meet the requirements of the ANSI Z359.15 American fall protection standard. The standard diameter provides a good grip for easier handling. EverFlex technology provides great flexibility and consistent performance over time. The sewn termination with protective sheath helps keep the connector in position and makes handling easy. Rope available in five lengths.













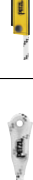

		Certifications	Weight
Mobile Fall Arresters			
ASAP	 B070AA00	<p>CE EN 12841 type A when used with an OK TRIACT-LOCK carabiner and an EN 1891 type A 10-13 mm rope. An ASAP'SORBER or ASAP'SORBER AXESS energy absorber can be used when needed.</p> <p>CE EN 353-2 when used with an OK TRIACT-LOCK carabiner and an ASAP'AXIS 11 mm rope. An ASAP'SORBER or ASAP'SORBER AXESS energy absorber can be used when needed.</p> <p>ANSI Z359.15 when used with an ASAP'SORBER or ASAP'SORBER AXESS energy absorber, a Bm'D or OXAN TRIACT-LOCK (international version) carabiner, a CAPTIV positioning bar, and a RAY 11 mm static rope with sewn termination.</p> <p>EAC when used with an OK TRIACT-LOCK carabiner and an EN 1891 type A 10-13 mm rope. An ASAP'SORBER or ASAP'SORBER AXESS energy absorber can be used when needed.</p> <p>XF 494 Light Use GB/T 24537 when used with an OK TRIACT-LOCK carabiner and an ASAP'SORBER or ASAP'SORBER AXESS energy absorber.</p>	295 g

ASAP LOCK	 B071BA00	<p>CE EN 12841 type A when used with an ASAP'SORBER or ASAP'SORBER AXESS energy absorber, and an EN 1891 type A 10 to 13 mm rope.</p> <p>CE EN 353-2 when used with an ASAP'SORBER or ASAP'SORBER AXESS energy absorber and an AXIS 11 mm rope with sewn termination.</p> <p>ANSI Z359.15 when used with an ASAP'SORBER or ASAP'SORBER AXESS energy absorber, a Bm'D or OXAN TRIACT-LOCK (international version) carabiner, a CAPTIV positioning bar, and a RAY 11 mm static rope with sewn termination.</p> <p>EAC when used with an ASAP'SORBER or ASAP'SORBER AXESS energy absorber, and an EN 1891 type A 10 to 13 mm rope.</p> <p>XF 494 Light Use GB/T 24537 when used with an OK TRIACT-LOCK carabiner and an ASAP'SORBER or ASAP'SORBER AXESS energy absorber.</p>	425 g
-----------	---	--	-------

	Lengths	Certifications	Weight
--	---------	----------------	--------

Absorbers for Mobile Fall Arresters			
ASAP'SORBER	 L071AA00	20 cm	125 g
	 L071AA01	40 cm	145 g
ASAP'SORBER AXESS	 L071CB00	40 cm	205 g

	Lengths	Certifications	Weight per Meter
--	---------	----------------	------------------

Ropes for Mobile Fall Arresters			
ASAP'AXIS 11 mm	 R074DA00	10 m	82 g
	 R074DA01	20 m	
	 R074DA02	30 m	
	 R074DA03	40 m	
	 R074DA04	50 m	
	 R074DA05	60 m	
AXIS 11 mm with sewn termination	 R074BA00	10 m	82 g
	 R074BA01	20 m	
	 R074BA02	30 m	
	 R074BA03	40 m	
	 R074BA04	50 m	
	 R074BA05	60 m	
RAY 11 mm with sewn termination	 R100BA00	25 ft	98 g
	 R100BA01	50 ft	
	 R100BA02	75 ft	
	 R100BA03	100 ft	
	 R100BA04	200 ft	



CONNECTORS

To address various situations encountered in the field, Petzl offers several types of connectors, with different shapes, sizes, gate openings, and locking systems.



Gearing up © 2024 Petzl Distribution - Lafauche - SPAR

▶ How to Choose the Right Connector

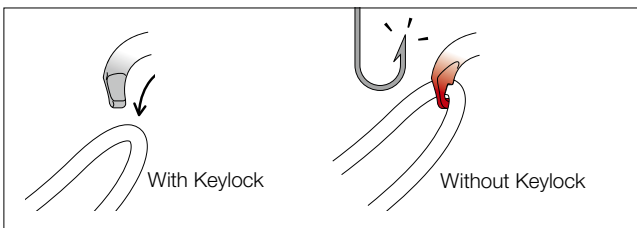

Keylock System: helps prevent snagging

To provide optimal efficiency, all Petzl carabiners use the Keylock system: the nose of the carabiner, where the body and gate meet, does not have a notch that could snag on anchors, ropes, harness equipment loops, or other gear.

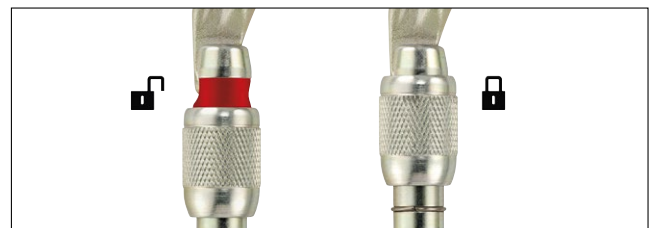

Visual locking indicator

To facilitate equipment checks, SCREW-LOCK manual locking carabiners have a red band that is visible only when the carabiner is not locked.

Lightweight Carabiners

Aluminum carabiners designed for workers at height.



Ultra-Lightweight Carabiners

Compact aluminum carabiners for workers at height looking to reduce weight to a minimum.



High-Strength Carabiners

Carabiners suitable for difficult environments, primarily used for setting up anchors and for connecting to metal structures.



Lanyard-End Connectors

Connectors designed for lanyard ends.



Special Carabiners

Aluminum carabiners designed for specific uses: with groups, for additional braking with a descender, and for harness fastening.



Semi-Permanent Connectors

Connectors designed for semi-permanent connection of equipment.



Connector Positioning Accessories

Accessories that keep the carabiner correctly positioned in devices and at the end of a lanyard.



Lightweight Carabiners

- Design facilitates handling

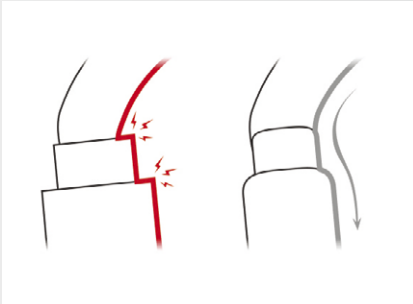

Fluid interior design

Fluid interior design limits the risk of having a catch point and facilitates rotation of the carabiner.



Optimal strength-to-weight ratio

The H-shaped cross section provides an optimal strength-to-weight ratio and protects the markings from abrasion.

- Multiple locking systems depending on the intensity of use:

- For frequent use:

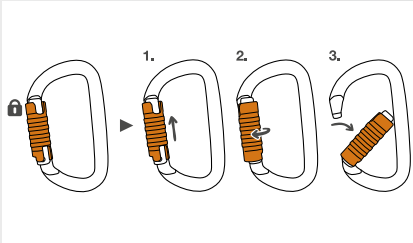

TRIACT-LOCK automatic system:

Unlocking is accomplished by raising, then turning the sleeve.

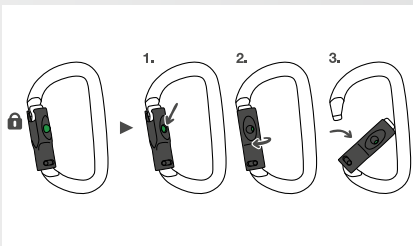

BALL-LOCK automatic system:

Unlocking is accomplished by pressing on the green indicator, then turning the sleeve. The green visual indicator is visible only when the gate is locked.

- For occasional use:

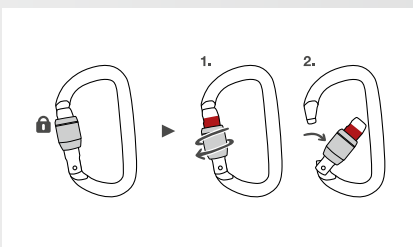

SCREW-LOCK manual system:

This system is ideal for harsh environments where contaminants (mud, ice) could cause an automatic locking system to jam. The red visual indicator is visible when the carabiner is unlocked.

- For connecting to equipment that has a large cross section



The OK carabiner has a symmetrical oval shape for optimal loading of devices with a large cross section, such as pulleys, rope clamps, or mobile fall arresters.

- For connecting equipment such as descenders or positioning lanyards



The Am'D carabiner has an asymmetrical D shape that is ideal for attaching equipment such as descenders or positioning lanyards.

- For connecting multiple items

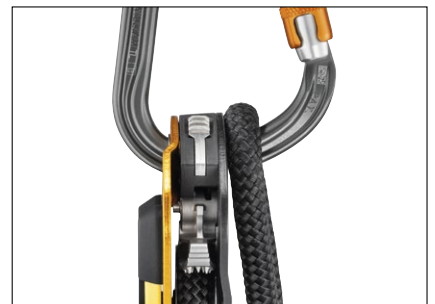

The WILLIAM has an asymmetrical pear shape, with a large capacity for attaching multiple elements, and a large gate opening to facilitate their installation.



CAPTIV
COMPATIBLE

OK Lightweight oval carabiner

The lightweight OK carabiner is made of aluminum. It has an oval shape that allows optimal loading of devices with a large cross section, such as pulleys, rope clamps, and mobile fall arresters. Designed with a smooth interior and Keylock system for ease of use. It is available in three locking systems: automatic TRIACT-LOCK or BALL-LOCK, or manual SCREW-LOCK. OK can be used with a CAPTIV positioning bar to help orient the carabiner to load the major axis, limit the risk of rotation, and keep it integrated with the device.



CAPTIV
COMPATIBLE

Am'D Lightweight asymmetrical carabiner

The Am'D lightweight asymmetrical carabiner is made of aluminum. It has a D shape particularly suited for connecting to diverse equipment such as descenders or positioning lanyards. Designed with a smooth interior and Keylock system for ease of use. The Am'D carabiner is available in three locking systems: automatic TRIACT-LOCK or BALL-LOCK system, or manual SCREW-LOCK system. Am'D may be used with a CAPTIV positioning bar to promote loading of the carabiner on the major axis, to limit the risk of rotation, and to keep it integrated with the device.



CAPTIV
COMPATIBLE

WILLIAM Lightweight asymmetrical large-capacity carabiner

The lightweight WILLIAM large-capacity asymmetrical carabiner is made of aluminum. The pear shape makes it easy to attach multiple items. Designed with a smooth interior and Keylock system for ease of use. The WILLIAM carabiner is available in three locking systems: automatic TRIACT-LOCK or BALL-LOCK, or manual SCREW-LOCK. WILLIAM can be used with the CAPTIV bar to promote positioning of the carabiner on the major axis, to limit the risk of rotation, and to keep it integrated with the device.



Connectors

Ultra-Lightweight Carabiners

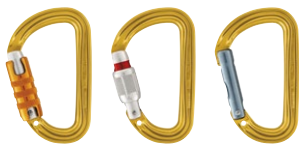

Sm'D Ultra-lightweight asymmetrical carabiner

The compact Sm'D asymmetrical aluminum carabiner is recommended for workers at height looking to reduce weight to a minimum. The D shape makes it especially suitable for attaching devices. It is available in two locking systems (automatic TRIACT-LOCK system or manual SCREW-LOCK system), or without a locking system.

High-Strength Carabiners



CAPTIV
COMPATIBLE



OXAN High-strength oval carabiner

OXAN is a high-strength steel carabiner designed for use in harsh environments. The oval, symmetrical shape allows the carabiner to be loaded in the optimal position when setting up anchors or connecting to metal structures. It is available in two locking systems: automatic TRIACT-LOCK system or manual SCREW-LOCK system. OXAN TRIACT-LOCK is available in European or international versions. OXAN can be used with the CAPTIV bar to promote positioning of the carabiner on the major axis, to limit the risk of rotation, and to keep it integrated with the device.



CAPTIV
COMPATIBLE



VULCAN High-strength, large-capacity, asymmetrical carabiner

VULCAN is a high-strength steel carabiner designed for use in harsh environments. The large-capacity asymmetrical shape is ideal for setting multiple anchors. The VULCAN carabiner is available in two locking systems: automatic TRIACT-LOCK system or manual SCREW-LOCK system. VULCAN TRIACT-LOCK is available in European or international versions. VULCAN can be used with a CAPTIV positioning bar to help orient the carabiner to load the major axis, limit the risk of rotation, and keep it integrated with the device.



CAPTIV
COMPATIBLE



Bm'D Lightweight asymmetrical high-strength carabiner

The Bm'D lightweight asymmetrical carabiner is made of aluminum. It has a D shape particularly suited for connecting to diverse equipment such as descenders or positioning lanyards. Designed with a smooth interior and Keylock system for ease of use. The Bm'D carabiner has the TRIACT-LOCK automatic locking system. The sleeve is reinforced for greater inward and lateral gate strength. Bm'D can be used with a CAPTIV positioning bar to help orient the carabiner to load the major axis, limit the risk of rotation, and keep it integrated with the device.

Lanyard-End Connectors

NEW
2025



VERTIGO TWIST-LOCK Connector for progression lanyard

The VERTIGO TWIST-LOCK connector is designed for use on progression lanyards. The excellent grip and automatic locking system make it easy to handle when passing intermediate anchors. The large opening and the Keylock system make it easy to connect. The VERTIGO TWIST-LOCK can be used with a TANGA positioning ring to help orient the carabiner to load the major axis, limit the risk of rotation, and keep it integrated with the ADJUST rope adjuster.

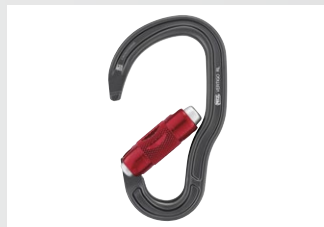

The TWIST-LOCK system is designed for passing intermediate anchors. It allows the connector to lock automatically when it closes and unlock with a simple rotation.



EASHOOK OPEN Connector with gated connection point for double lanyard and work-positioning lanyard

The EASHOOK OPEN connector is designed for use at the ends of a double lanyard or work-positioning lanyard. The gated connection point allows the connector to be directly attached to the lanyard. If the lanyard is damaged, the connector can be reused. The excellent grip and automatic locking system make it easy to handle when passing intermediate anchors.



MGO OPEN

Auto-locking directional connector with large gate opening and a gated connection point

MGO OPEN is an auto-locking directional connector with a large gate opening for connection to metal structures or to large-diameter cables and bars. It has a gated connection point for attachment to different types of lanyards. If the lanyard is damaged, the connector can be reused. MGO OPEN is available in two versions: 60 and 110 mm.

Special Carabiners



Am'D PIN-LOCK

Asymmetrical aluminum carabiner, unlocks with a tool

The Am'D PIN-LOCK asymmetrical aluminum carabiner is designed for use with groups. It secures the connection of the participant with a PIN-LOCK system, which can only be opened by the operator with a specific unlocking tool. Am'D PIN-LOCK can be used with a CAPTIV positioning bar to help orient the carabiner to load the major axis, limit the risk of rotation, and keep it integrated with the device.



FREINO Z

Carabiner with friction spur for descenders

The FREINO Z carabiner has a friction spur for adding or adjusting friction during the descent. It is easy to use and compatible with I'D S, I'D L, I'D EVAC, and RIG self-braking descenders. When rotated, it makes the descender drop resistant when being transferred from the equipment loop to the ventral attachment point or anchor. The FREINO Z has the TRIACT-LOCK automatic locking system.



NEW
2025



OMNI

Multidirectional semi-circle carabiner

Multidirectional semi-circle OMNI carabiner for fastening FALCON ASCENT, NEWTON, and VOLT harnesses or attaching a CROLL ventral rope clamp. It is available in two locking systems: automatic TRIACT-LOCK system or manual SCREW-LOCK system.



The OMNI carabiner can be used to fasten the FALCON ASCENT harness by joining the two textile attachment points.

Semi-Permanent Connectors



RING OPEN

Multidirectional gated ring

The RING OPEN gated ring is designed for semi-permanent connection of equipment. The round shape allows it to function optimally in all directions. It has a large opening that allows installation of ropes with sewn terminations.



DELTA

Triangular steel quick link

When closed with a wrench, this steel quick link becomes a semi-permanent anchor ring.



GO

Oval steel quick link

When closed with a wrench, this steel quick link becomes a semi-permanent anchor ring.



DEMI ROND

Semi-circle aluminum alloy quick link

When closed with a wrench, this aluminum quick link is used to fasten harnesses that have two attachment points that must be joined with a connector.



Connectors

Connector Positioning Accessories

 How to Install the CAPTIV Positioning Bar



CAPTIV

Connector positioning bar (pack of 10)

The CAPTIV positioning bar helps orient the carabiner to load the major axis, limits the risk of rotation, and keeps it integrated with the device or lanyard. CAPTIV is compatible with OK, Am'D, WILLIAM, OXAN, VULCAN, Bm'D carabiners, and the ROLLCLIP A pulley carabiner.



CAPTIV ADJUST

Carabiner positioning bar combined with an ADJUST rope adjuster

The CAPTIV ADJUST positioning bar helps orient the carabiner to load the major axis and holds the ADJUST rope adjuster in the proper position to reduce the risk of accidental release. It helps keep the lanyard and rope adjuster integrated with the carabiner, reducing the risk of losing them. CAPTIV ADJUST is compatible with OK, Am'D, Bm'D, and OXAN carabiners.



STUART

Connector positioning accessory (pack of 10)

STUART helps keep the connector in the correct position and facilitates clipping. It is compatible with most auto-locking connectors.



TANGA

Connector positioning ring (pack of 10)

















The TANGA positioning ring helps hold the connector in the correct position.



STRING

Accessory for maintaining connector orientation and protecting the webbing (pack of 10)

STRING helps maintain the proper orientation of the connector and protects the webbing from wear.

Lock	References					Certifications	Weight
Lightweight Carabiners							
OK	 TRIACT-LOCK	M33A TL M33A TLN (1)	22 mm				75 g
	 BALL-LOCK	M33A BL	23 mm	25 kN	8 kN	7 kN	75 g
	 SCREW-LOCK	M33A SL M33A SLN (1)	22 mm				70 g
Am'D	 TRIACT-LOCK	M34A TL M34A TLN (1) M34A TLY (2)	24 mm				75 g
	 BALL-LOCK	M34A BL M34A BLY (2)	25 mm	27 kN	8 kN	7 kN	75 g
	 SCREW-LOCK	M34A SL M34A SLN (1)	25 mm				70 g
WILLIAM	 TRIACT-LOCK	M36A TL M36A TLN (1) M36A TLY (2)	27 mm				90 g
	 BALL-LOCK	M36A BL M36A BLY (2)	27 mm	27 kN	8 kN	8 kN	90 g
	 SCREW-LOCK	M36A SL M36A SLN (1)	28 mm				85 g
Ultra-Lightweight Carabiners							
Sm'D	 TRIACT-LOCK	M39A TL M39A TLN (1)	18 mm				55 g
	 SCREW-LOCK	M39A SL M39A SLN (1)	20 mm	23 kN	8 kN	7 kN	45 g
	 Non-Locking	M39A S M39A SN (1)	23 mm				40 g

Lock		References						Certifications	Weight
High-Strength Carabiners									
OXAN		TRIACT-LOCK European Version	M72A TL	22 mm				CE EN 362 NFPA 2500 Technical Use EAC GB/T 23469, XF 494	195 g
		TRIACT-LOCK International Version	M72A TLA M72A TLN (1)	20 mm	38 kN	16 kN	15 kN	CE EN 362 ANSI Z359.12 NFPA 2500 Technical Use CSA Z259.12 EAC	230 g
		SCREW-LOCK	M72A SL M72A SLN (1)	22 mm				CE EN 362 NFPA 2500 Technical Use EAC GB/T 23469, XF 494	185 g
VULCAN		TRIACT-LOCK European Version	M073BA00	28 mm				CE EN 362 NFPA 2500 General Use EAC GB/T 23469, XF 494	245 g
		TRIACT-LOCK International Version	M073CA00 M073CA01 (1)	26 mm	45 kN	16 kN	18 kN	CE EN 362 ANSI Z359.12, NFPA 2500 General Use, CSA Z259.12 EAC	265 g
		SCREW-LOCK	M073AA00 M073AA01 (1)	29 mm				CE EN 362 NFPA 2500 General Use EAC GB/T 23469, XF 494	235 g
Bm'D		TRIACT-LOCK	M032AA00 M032AA01 (1)	18 mm	32 kN	16 kN	10 kN	CE EN 362 ANSI Z359.12, ANSI Z459.1 NFPA 2500 Technical Use CSA Z259.12 EAC XF 494 FZL-G-Q, GB/T 23469 Type B	105 g
Lanyard-End Connectors									
NEW 2025		VERTIGO TWIST-LOCK	M041AA00	25 mm	25 kN	10 kN	8 kN	CE EN 362 B, EN 12275 class B & K GB/T 23469 B & K	75 g
		EASHOOK OPEN	M043AA00 M043AA01 (1)	25 mm	25 kN	-	10 kN	CE EN 362 EAC	160 g
		MGO OPEN 60	MGOO 60	63 mm	23 kN	-	23 kN	CE EN 362 EAC	490 g
		MGO OPEN 110	M080AA00	110 mm					930 g
Special Carabiners									
Am'D		PIN-LOCK	M34A PL (x1) M34AB PL (x10)	25 mm	27 kN	8 kN	7 kN	CE EN 362, EN 12275 EAC	80 g
FREINO Z		TRIACT-LOCK	M042BA00	18 mm	23 kN	8 kN	8 kN	CE EN 362, EN 12275 NFPA 2500 Technical Use EAC GB/T 23469 / B	75 g
NEW 2025		TRIACT-LOCK	M037BA00	21 mm	20 kN	15 kN	8 kN	CE EN 362 B & M, EN 12275 class B GB/T 23469 type B & K	80 g
OMNI		SCREW-LOCK	M037AA00						75 g
Semi-Permanent Connectors									
RING OPEN		Gated Ring	P28 M028AA00	11 mm	23 kN	23 kN	-	CE EN 362	70 g
DELTA		Quick Link	P11	12 mm	45 kN	10 kN	-	CE EN 362 type Q EN 12275	150 g
		Quick Link	P11 8, P11 8B, P11 8BN (1)	10 mm	27 kN	10 kN			85/95 g
GO		Quick Link	P15	16 mm	25 kN	10 kN			60 g
DEMI ROND		Quick Link	P18	10 mm	25 kN	10 kN			55 g
Connector Positioning Accessories									
CAPTIV			M093AA00	10 g	STUART			M096AA00	10 g
CAPTIV ADJUST			M095AA00	10 g	TANGA			M92000	5 g
					STRING			M090AA01	10 g

(1) Black connector, (2) Gold connectors.



DESCENDERS

Descenders are designed to help regulate friction and control the descent on a fixed rope. They allow a worker to position themselves at any point on the rope. Certain Petzl descenders can also be used as belay devices.



Self-Braking Descenders

Self-braking descenders with ergonomic handle and AUTO-LOCK system allow a comfortably controlled descent and easy positioning at the workstation. These devices are designed for work at height, rope access, and technical rescue and evacuation.



Descenders for Technical Rescue

Descenders with integrated progress-capture pulley and AUTO-LOCK system to facilitate lowering and raising heavy loads.



Mechanical Prusiks for Tree Care

Mechanical Prusiks allow the user to move around efficiently in a tree while benefiting from the handling of a classic Prusik pulley system.



Standard Descenders

Descenders with a simple design, using the friction between the rope and the device to brake a descent. The speed of the descent is regulated by varying the grip on the free end of the rope.

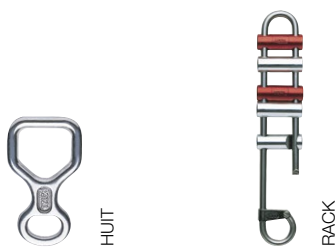

Personal Escape System

Rescue device that allows a single person to get themselves out of a building or structure in the event of an emergency. It has a multipurpose anchor hook adapted for locations where the possibility of finding an anchor point is uncertain.



Descenders

Self-Braking Descenders

Easy to use, self-braking descenders adapt to a variety of situations encountered during work at height, rope access work, or technical rescue: descending, work positioning, short rope ascents, belaying with climbing techniques.

- Easy to use

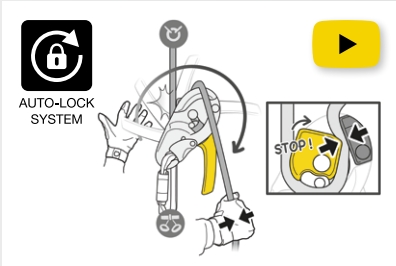

AUTO-LOCK system

The AUTO-LOCK system allows users to easily position themselves at a workstation without having to manipulate the handle or tie off the device: as soon as the user releases the handle, the rope is automatically locked in the device.



Installing the rope

The device has a safety gate on the moving side plate that allows the rope to be easily installed while the device remains connected to the harness.



Comfortable, controlled descent

The ergonomic handle allows the user to unblock the rope and comfortably control the descent. Two descent modes are possible: on the side plate or in the V-shaped friction channel.

- Versatile

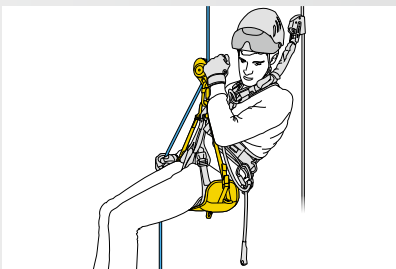

Self-braking descenders are versatile and can be used for both descents and short rope ascents.

- Wear resistant



The stainless steel wear plate improves durability by reinforcing the rope friction zone.

- With anti-panic function and anti-error catch

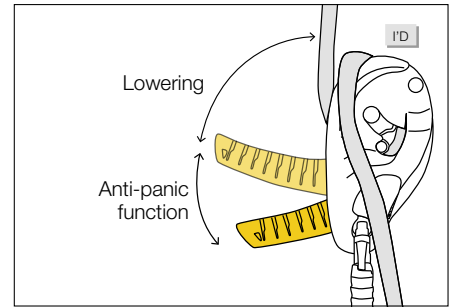

Designed for work at height, rope access, and technical rescue and evacuation, these devices are equipped with an anti-panic function and an anti-error catch, to reduce the risk of an accident due to user error. They are also compatible with auxiliary brakes, which help increase the friction for lowering heavy loads.

- Compact and lightweight



The RIG descender is compact and lightweight, and designed for experienced rope access workers.

I'D self-braking descenders with anti-panic function

UPDATED
2025



I'D® S

Self-braking descender with anti-panic function for work at height and rope access work

The self-braking I'D S descender is primarily designed for work at height and rope access work. It has an ergonomic handle that allows comfortable descent control. The integrated anti-panic function and anti-error catch reduce the risk of an accident due to user error. The AUTO-LOCK system allows users to easily position themselves at the workstation without having to manipulate the handle or tie off the device. Once locked, the rope can be taken up without having to manipulate the handle. The safety gate allows the rope to be installed with the device remaining connected to the harness. I'D S is compatible with 10 to 11.5 mm ropes.



I'D® L

Self-braking descender with anti-panic function for rescue

The I'D L self-braking descender is primarily designed for rescue. It has an ergonomic handle that allows comfortable descent control. The integrated anti-panic function and anti-error catch reduce the risk of an accident due to user error. The AUTO-LOCK system allows users to position themselves without having to manipulate the handle or tie off the device. Once locked, the rope can be taken up without having to manipulate the handle. The safety gate allows the rope to be installed with the device remaining connected to the harness. I'D L is compatible with 12.5 to 13 mm ropes.



I'D® EVAC

Self-braking descender with anti-panic function for lowering from an anchor

The I'D EVAC self-braking descender is primarily designed for lowering from an anchor. The ergonomic handle is specifically oriented for managing a load from the anchor and offers comfortable descent control. The integrated anti-panic function and anti-error catch reduce the risk of an accident due to user error. The AUTO-LOCK system allows the rope to be automatically locked without having to manipulate the handle or tie off the device. Once locked, the rope can be taken up without having to manipulate the handle. The safety gate allows the rope to be installed with the device remaining connected to the anchor. I'D EVAC is compatible with 10 to 11.5 mm ropes.

Accessories



Open Auxiliary Brake for I'D®

Open auxiliary brake for I'D S, I'D L, and I'D EVAC self-braking descenders

The open auxiliary brake is designed for I'D self-braking descenders. It is used to add friction depending on the load and rope diameter, and allows the rope to be inserted or removed at any time.



Closed Auxiliary Brake for I'D®

Closed auxiliary brake for I'D S, I'D L, and I'D EVAC self-braking descenders

The closed auxiliary brake is designed for I'D self-braking descenders. It is used to add friction depending on the load and rope diameter and provides a constant redirect of the rope.



RIG®

Compact self-braking descender for rope access, designed for experienced users

RIG is a compact self-braking descender for rope access, designed for experienced users. It has an ergonomic handle that allows comfortable descent control. The AUTO-LOCK system allows users to easily position themselves at the workstation without having to manipulate the handle or tie off the device. Once locked, the rope can be taken up without having to manipulate the handle. The safety gate allows the rope to be installed with the device remaining connected to the harness.



Descenders

Descenders for Technical Rescue

These descenders offer the versatility required for technical rescue operations: lowering, hauling, handling heavy loads, use in the primary system or in a backup belay.

- **Easy rope installation**



Markings on the device make rope installation quick and easy.

- **Comfortable, controlled descent, even with heavy loads**



The ergonomic handle and integrated brake enable a comfortably controlled descent.



The faceted sheave creates additional friction zones for the rope, providing extra braking for lowering heavy loads.

- **Excellent hauling efficiency**

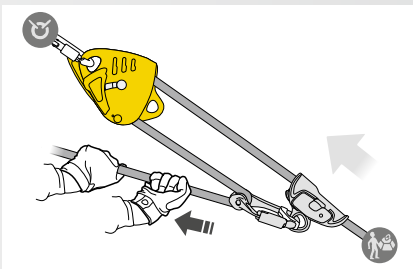

The integrated progress-capture pulley with very large diameter sheave mounted on sealed ball bearings rotates in only one direction for excellent hauling efficiency. The lower connection point can be used to create different types of haul systems.

- **AUTO-LOCK system: automatically locks the rope**

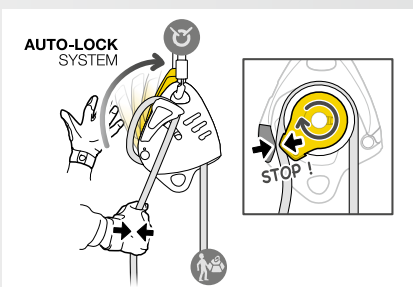

AUTO-LOCK SYSTEM

The AUTO-LOCK system allows automatic locking of the rope when the handle is not in use. Once locked, the rope can be taken up without having to manipulate the handle.

MAESTRO S

Ø 10 to 11.5 mm

 250 kg

MAESTRO L

Ø 12.5 to 13 mm

 280 kg

▶ MAESTRO descenders with integrated progress-capture pulley

UPDATED
2025



MAESTRO® S

Descender with integrated progress-capture pulley for loads up to 250 kg, compatible with 10 to 11.5 mm ropes

MAESTRO S is a descender designed for technical rescue operations. It makes it easier to manipulate heavy loads when lowering or hauling, and may be used in both the primary system or in a backup belay. This versatility allows rescuers to adapt to a variety of different situations they may encounter on the rescue scene. The ergonomic handle and integrated brake enable a comfortably controlled descent. Changing from lowering to hauling is immediate, without the need to transfer the load. The integrated progress-capture pulley has a large diameter sheave mounted on sealed ball bearings, providing excellent hauling efficiency. The AUTO-LOCK system automatically locks the rope when the handle is not in use. Once locked, the rope can be taken up without having to manipulate the handle. The MAESTRO S descender is compatible with 10 to 11.5 mm ropes and can handle loads up to 250 kg.



MAESTRO® L

Descender with integrated progress-capture pulley for loads up to 280 kg, compatible with 12.5 to 13 mm ropes

MAESTRO L is a descender designed for technical rescue operations. It makes it easier to manipulate heavy loads when lowering or hauling, and may be used in both the primary system or in a backup belay. This versatility allows rescuers to adapt to a variety of different situations they may encounter on the rescue scene. The ergonomic handle and integrated brake enable a comfortably controlled descent. Changing from lowering to hauling is immediate, without the need to transfer the load. The integrated progress-capture pulley has a large diameter sheave mounted on sealed ball bearings, providing excellent hauling efficiency. The AUTO-LOCK system automatically locks the rope when the handle is not in use. Once locked, the rope can be taken up without having to manipulate the handle. The MAESTRO L descender is compatible with 12.5 to 13 mm ropes and can handle loads up to 280 kg.



Descenders

Mechanical Prusiks for Tree Care

Mechanical Prusiks allow arborists to optimize their movement within a tree. They are user-friendly and intuitive to use. To meet a variety of needs, they can be used on doubled ropes or a single rope.

• Intuitive design



The technique is identical to that of a classic Prusik pulley system, offering immediate usability. The device locks automatically once the friction chain is extended.

• For efficient movement



Smooth, precise rope feed

The release lever is mounted on a spring for great precision when moving around. Adjusting the pressure on this lever controls the speed of movement.

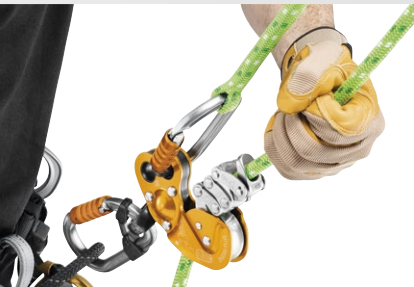

Slack easily taken up

The pulley is mounted on sealed ball bearings to allow the slack to be taken up easily when moving around. The widely spaced side plates also contribute to smooth rope glide.

• Versatile



Use on doubled ropes

ZIGZAG and ZIGZAG PLUS can be used on doubled ropes.

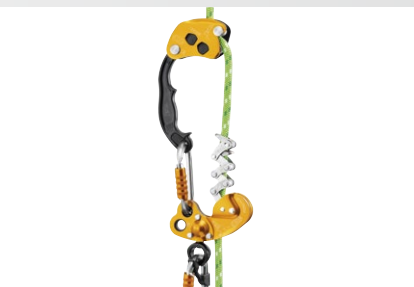

Use on a single rope

They can also be used on a single rope, thanks to the CHICANE accessory, which offers more friction on the descent, and the KNEE ASCENT assemblies, which facilitate the ascent.

• Standard version



The lower attachment hole is fixed to maintain alignment of the device with the axis of the worker and to optimize grip.

• Version with high-efficiency swivel



The lower attachment hole with high-efficiency swivel provides stable and correct positioning of the mechanical Prusik and optimal rope glide through the device.



ZIGZAG®

Mechanical Prusik for tree care

The ZIGZAG mechanical Prusik allows the user to move around efficiently in a tree using classic Prusik pulley system technique. The friction chain provides precision and fluidity when moving around. The pulley is mounted on sealed ball bearings to allow the slack to be taken up easily. Can be used on either doubled ropes or a single rope, providing great versatility. The lower attachment hole is fixed to maintain alignment of the device with the axis of the worker and to optimize grip.



ZIGZAG PLUS mechanical Prusik



ZIGZAG® PLUS

Mechanical Prusik with high-efficiency swivel, for tree care

The ZIGZAG PLUS mechanical Prusik allows the user to move around efficiently in a tree using classic Prusik pulley system technique. The friction chain provides precision and fluidity when moving around. The pulley is mounted on sealed ball bearings to allow the slack to be taken up easily. Can be used on either doubled ropes or a single rope, providing great versatility. The lower attachment hole with high-efficiency swivel provides stable and correct positioning of the mechanical Prusik and optimal rope glide through the device.

Accessories



CHICANE

Auxiliary brake for mechanical Prusik on single ropes, for tree care

The CHICANE auxiliary braking device allows ZIGZAG and ZIGZAG PLUS mechanical Prusiks to be used on single ropes. It provides continuous additional friction on descents. The excellent compatibility of the CHICANE and mechanical Prusik as an assembled unit provides smooth rope glide through the brake during ascents. The ergonomic handle provides excellent grip and facilitates movement while limb walking. With the openable side plate, installation is quick and easy.



Descenders

Standard Descenders



HUIT

Figure-eight descender

Figure-eight descender, compact and lightweight. Square shape helps reduce rope twist.



RACK

Variable friction descender with brake bars

The design and configuration of the RACK bars make it easy to set up and insert the rope. Compact and lightweight, the device allows the user to adjust the amount of friction during the descent to adapt to changing conditions.

Personal Escape System

EXO® AP HOOK

Personal escape system with anchor hook

EXO AP HOOK is a personal escape system with a HOOK anchor hook, adapted for situations where the possibility of finding an anchor point is uncertain. It has a self-braking system with anti-panic function for quickly moving horizontally, climbing through a window, and controlling or stopping a descent. If the user pulls too hard on the handle, the anti-panic function brakes and stops the descent automatically. EXO AP HOOK also includes a rope that resists wear and high temperatures, an Am'D connector with CAPTIV positioning bar, and a bag for transporting and attaching the system directly to the harness. Other rope lengths and other types of connectors (such as the EASHOOK OPEN) are available by special order.

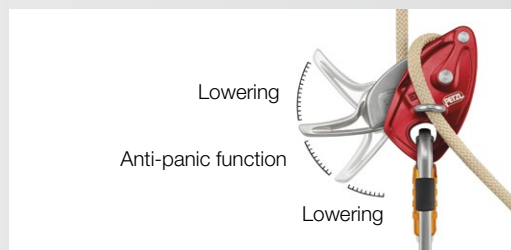

If the user pulls too hard on the handle, the anti-panic function brakes and stops the descent automatically.



The anchor hook may be used around a structure, secured with a locking hitch.

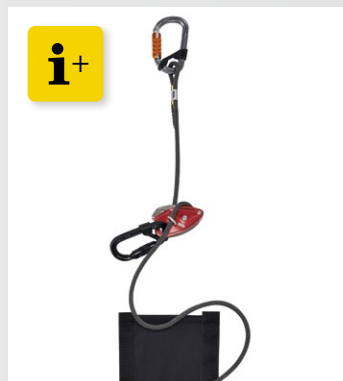

Petzl Custom allows you to choose:

- Rope type: Standard or high-strength rope
- Rope color
- Rope length
- Type of rope-end connectors and harness connector

The assembly of various components of your choice offers a ready-made solution specific to the user, delivered in a transport pouch or bag adapted to the length of the rope.

Because of the unique shape of the anchor hook, special Petzl training for the EXO AP HOOK is mandatory.

			Certifications	Rope Diameter Compatibility	Working Load Limit	Weight
Self-Braking Descenders						
 I'D S	D020AA00 (yellow) D020AA01 (black)	EN 341 type 2 class A CE EN 12841 type C CE EN 15151-1 ANSI Z359.9, ANSI Z459.1 NFPA 2500 Technical Use NFPA 2500 General Use EAC XF 494 Light Use GB/T 38230 II A (1)	10 to 11.5 mm	150 kg for single-person use, and up to 250 kg for rescue use (and up to 272 kg when used with an 11 mm diameter NFPA-certified General Use rope)	600 g	
I'D L 	D020BA00 (yellow) D020BA01 (black)	EN 341 type 2 class A CE EN 12841 type C ANSI Z359.9 NFPA 2500 General Use EAC (1)	12.5 to 13 mm	150 kg for single-person use, and up to 280 kg for rescue use	600 g	
I'D EVAC 	D020CA00 (yellow) D020CA01 (black)	EN 341 type 2 class A CE EN 12841 type C ANSI Z359.9, ANSI Z459.1 NFPA 2500 Technical Use EAC (1)	10 to 11.5 mm	150 kg for single-person use, and up to 250 kg for rescue use	615 g	
RIG 	D021AA00 (yellow) D021AA01 (black)	CE EN 12841 type C EN 341 type 2 class A CE EN 15151-1 ANSI Z359.9, ANSI Z459.1 NFPA 2500 Technical Use EAC XF 494 Light Use GB/T 38230 II A (1)	10 to 11.5 mm	Handling of loads up to 200 kg	400 g	
Open Auxiliary Brake for I'D	D020DA00	-	-	-	20 g	
Closed Auxiliary Brake for I'D	D020EA00	-	-	-	20 g	
Rescue Descenders						
 MAESTRO S	D024AB00	CE EN 12841 type C, EN 341 NFPA 2500 Technical Use NFPA 2500 General Use ANSI Z359.9, ANSI Z459.1 EAC (1)	10 to 11.5 mm	Handling of loads up to 250 kg (and up to 272 kg when used with an 11 mm diameter NFPA-certified General Use rope)	1100 g	
MAESTRO L 	D024BA00	CE EN 12841 type C, EN 341 NFPA 2500 General Use EAC XF 494 General Use GB/T 38230 II A (1)	12.5 to 13 mm	Handling of loads up to 280 kg	1100 g	
Mechanical Prusiks for Tree Care						
ZIGZAG 	D022AA00	CE	11.5 to 13 mm	140 kg	365 g	
ZIGZAG PLUS 	D022BA00	CE	11.5 to 13 mm	140 kg	425 g	
CHICANE 	D022CA00	CE (with ZIGZAG or ZIGZAG PLUS mechanical Prusik)	11.5 to 13 mm	140 kg	255 g	
Standard Descenders						
HUIT 	D02	-	8 to 13 mm (single and double rope)	100 kg	100 g	
RACK 	D11	-	9 to 13 mm (single rope) 8 to 11 mm (double rope)	100 kg	470 g	
Personal Escape System						
EXO AP HOOK 	D031DA00	NFPA 2500 Escape Use	7.5 mm (EXO rope only)	140 kg	1470 g	

(1) More information in the Instructions for Use



ROPE CLAMPS

Petzl rope clamps are primarily used for progression on ropes and for setting up haul systems.



Glass window maintenance, Tour Crayon de la Part-Dieu, Lyon, France © 2024 Petzl Distribution - Lafouche - Bleu Ciel Services (BCS) - Tour Crayon de la Part-Dieu



Optimal locking

Petzl frame-loaded rope clamps are designed to function optimally under many different conditions (wet, frozen, dirty ropes, for example). They are therefore equipped with a special stainless steel cam. Its unique design, the shape of its teeth, and its self-cleaning slot allow optimal grip on the rope without damaging it, while reducing the effort required to slide the device up the rope.

Rope Clamps for Progression

Frame-loaded rope clamps are easy to install and specially designed for rope ascents (handled rope clamps, ventral rope clamps, and foot ascenders).



Versatile Rope Clamp

Rope clamp that can be used to ascend a fixed rope, or as progress capture in a haul system.



Backup Rope Clamp

Ultra-compact, lightweight rope clamp for occasional rope ascents and haul systems.



Cam-Loaded Rope Clamp

Rope clamp designed for use in haul systems as a tractor or progress-capture device.



Rope Clamps

Rope Clamps for Progression



ASCENSION
left-handed

ASCENSION
right-handed

ASCENSION

Handled rope clamp for rope ascents

The ASCENSION handled ascender is designed for rope ascents and features an overmolded handle and ergonomic top section for a comfortable and powerful grip when pulling with one or two hands. The ASCENSION handled rope clamp has a large lower hole for easily attaching two carabiners for a lanyard and foot loop.



The overmolded dual-density grip has an area for the index finger and a wide, supportive base to keep the hand from slipping. Ergonomic upper part maximizes power when pulling with two hands.



PROGRESS ADJUST-Y

Double adjustable progression lanyard



FOOTAPE

Adjustable webbing foot loop

The adjustable FOOTAPE foot loop is used with an ASCENSION or BASIC rope clamp for rope ascents. A height-adjustable elastic band keeps the foot in the loop, regardless of shoe type.

FOOTCORD

Adjustable cord foot loop

The adjustable FOOTCORD foot loop is used with an ASCENSION or BASIC rope clamp for rope ascents. Its high-modulus polyethylene construction increases durability. A height-adjustable elastic band keeps the foot in the loop, regardless of shoe type.

LOOPING

Four-step etrier

The LOOPING four-step etrier attaches to an ASCENSION rope clamp for rope ascents or directly onto an anchor for progression in overhangs.



CROLL® Ventral rope clamp

Designed for rope ascents, the CROLL ventral rope clamp is simple to use, with a pinch opening system, which is totally integrated in the clamp to avoid any involuntary snagging. The attachment holes allow efficient positioning during ascents. It is available in two versions to adapt to different rope diameters.



SECUR Shoulder straps for positioning the CROLL ventral rope clamp

SECUR shoulder straps position the CROLL ventral rope clamp and attach to AVAO SIT, FALCON, FALCON ASCENT, and SEQUOIA SRT harnesses.



ASCENTREE Double-handled rope clamp for tree care

Handled rope clamp designed for double rope ascents, the ASCENTREE has ergonomic handles allowing a comfortable and powerful grip when pulling. Catch/cam unit is totally integrated to prevent any involuntary snagging.



PANTIN
left-foot

PANTIN
right-foot

PANTIN® Foot ascender

The PANTIN foot ascender is used with the CROLL, ASCENSION, or ASCENTREE rope clamps to make rope ascents faster and less tiring. It is available in right- and left-foot versions.

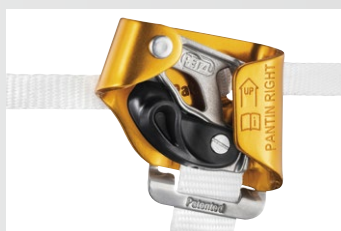

Catch to keep the rope in the device during rope ascents.



Installing the
KNEE ASCENT

KNEE ASCENT LOOP

Knee ascender assembly with foot loop to facilitate ascents on a single rope, for tree care

The KNEE ASCENT LOOP assembly facilitates the arborist's ascent when using the ZIGZAG or ZIGZAG PLUS mechanical Prusik on a single rope. It contains an upper strap, a CROLL L rope clamp, a lower strap with foot loop, and a TOOLBAG 1.5 tool pouch. The system is fully adjustable and adapts to different body types.

KNEE ASCENT CLIP

Knee ascender assembly with boot connector, facilitating single rope ascents, for tree care

The KNEE ASCENT CLIP assembly facilitates the arborist's ascent when using the ZIGZAG or ZIGZAG PLUS mechanical Prusik on a single rope. It contains an upper strap, a CROLL L rope clamp, a lower strap with connector that attaches to the sewn webbing on the top of the arborist's boot, and a TOOLBAG 1.5 tool pouch. The system is fully adjustable and adapts to different body types.



Rope Clamps

Versatile Rope Clamp



BASIC

Compact, versatile rope clamp

The BASIC rope clamp is very compact, making it easy to grip. The large lower hole allows lanyard and foot loop carabiners to be easily connected.

Backup Rope Clamp



TIBLOC

Backup Rope Clamp

Extremely compact and lightweight, the TIBLOC is a backup rope clamp for ascending ropes or setting up haul systems.

Cam-Loaded Rope Clamp



RESCUCENDER

Openable cam-loaded rope clamp

Simple to use and ergonomic, the RESCUCENDER is an openable cam-loaded rope clamp designed for use in haul systems as a tractor or progress-capture device.



Openable guided cam allows easy installation or removal of the rope clamp at any point on the rope.

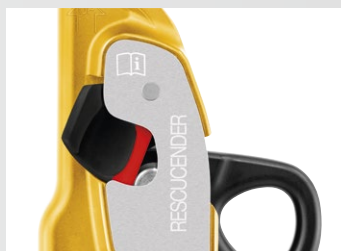

The safety catches are equipped with indicators that show when they are unlocked.

			Certifications	Rope Diameter Compatibility	Weight
Rope Clamps for Progression					
ASCENSION		B17ALA (left-handed, black/yellow) B17ALN (left-handed, black) B17ARA (right-handed, black/yellow) B17ARN (right-handed, black)	CE EN 567, EN 12841 type B NFPA 2500 Technical Use EAC XF 494: FZL-SS-Q10/13	8 to 13 mm	165 g
FOOTAPE		C47A	-	-	65 g
FOOTCORD		C48A	-	-	40 g
LOOPING		C25	-	-	145 g
CROLL S		B16BAA	CE EN 567, EN 12841 type B NFPA 2500 Technical Use EAC XF 494	8 to 11 mm	85 g
CROLL L		B016AA00	CE EN 567, EN 12841 type B NFPA 2500 Technical Use EAC XF 494	8 to 13 mm	140 g
SECUR		C74A	-	-	135 g
ASCENTREE		B19AAA	CE	8 to 13 mm	330 g
PANTIN		B02CLA (left-foot) B02CRA (right-foot)	The PANTIN is not an item of PPE	8 to 13 mm	85 g
Catch for PANTIN		B02210 (for left foot PANTIN) B02200 (for right foot PANTIN)	-	-	25 g
KNEE ASCENT LOOP		D022DA00	-	8 to 13 mm	280 g
KNEE ASCENT CLIP		D022EA00	-	8 to 13 mm	285 g
Versatile Rope Clamp					
BASIC		B18BAA	CE EN 567, EN 12841 type B EAC XF 494	8 to 11 mm	85 g
Backup Rope Clamp					
TIBLOC		B01BN	CE EN 567 EAC	8 to 11 mm	35 g
Cam-Loaded Rope Clamp					
RESCUCENDER		B50A	CE EN 567, EN 12841 type B NFPA 2500 Technical Use EAC XF 494: FZL-Z-Q (3)	9 to 13 mm (1) 10 to 13 mm (2)	260 g

(1) For the CE EN 567 standard, (2) for the other standards, (3) when used with a 9.5 to 13 mm rope.



PULLEYS

Pulleys are used for raising equipment and for making haul systems in a rescue situation. Some of them can be combined with a rope clamp to facilitate maneuvers; others allow movement along rope or cable.



© 2022 Petzl Distribution - Vuedici.org

Two factors determine a pulley's efficiency:

- Sheave size: the larger the sheave diameter, the higher the efficiency
- Bushings and bearings:
 - Self-lubricating bushings are efficient, but they must be regularly maintained
 - Sealed ball bearings are very efficient, and they do not require any maintenance

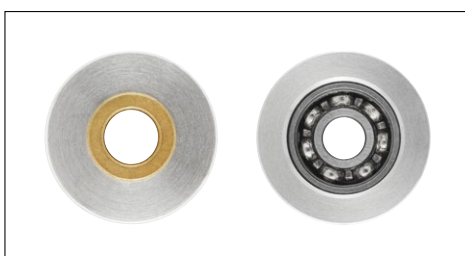

High-Efficiency Pulleys With Swivel

High-performance pulleys equipped with a swivel, making them drop resistant while installing the rope.



High-Efficiency Pulleys

Versatile, high-performance pulleys adapted for intensive use.



Pulley-Carabiners

Pulley-carabiners with excellent efficiency.



Progress-Capture Pulleys

Pulleys with an integrated progress-capture system may be used to replace a traditional pulley/rope clamp setup in haul systems.



Prusik Pulleys

High-performance pulleys designed for use with a Prusik friction hitch to build a lightweight progress-capture system. The shape of the side plates allows the knot to be released when it stops against the pulley.



Single Pulleys

Lightweight, versatile pulleys designed for situations that do not require a high level of efficiency (such as redirecting the rope).



Transport Pulleys

Pulleys designed for movement along a rope or cable.



Haul System

Ready-to-use kit, designed to easily pick off and lower (or simply pick off) a victim.

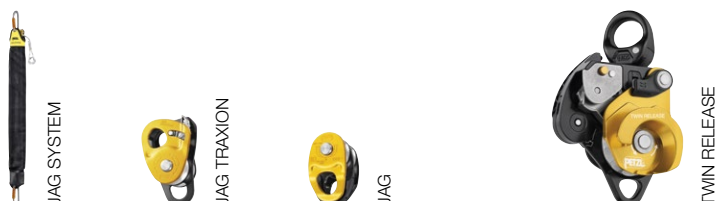

High-Efficiency Pulleys With Swivel



 SPIN L1 and SPIN L2 pulleys

SPIN L1

Very high efficiency single pulley with swivel

Possible to open, even when attached to the anchor, the SPIN L1 pulley is designed for maximum simplicity in setting up haul or load deviation systems and tensioned highlines. The large-diameter sheave mounted on sealed ball bearings gives it excellent efficiency. The swivel makes it easier to operate, allowing the pulley to be oriented under load and for carabiners, ropes, or slings to be directly connected.



SPIN L2

Very high efficiency double pulley with swivel

Possible to open, even when attached to the anchor, the SPIN L2 is a double pulley designed for maximum simplicity when setting up haul systems or tensioned highlines. The two parallel-mounted sheaves and auxiliary attachment point allow the pulley to be used to set up various types of complex haul systems. The large-diameter sheaves mounted on sealed ball bearings provide excellent efficiency. The swivel makes it easier to operate, allowing the pulley to be oriented under load and for carabiners, ropes, or slings to be directly connected.

 SPIN L1D pulley



SPIN L1D

Very high efficiency single pulley with one-way rotation and swivel

Possible to open, even when attached to the anchor, the SPIN L1D pulley is designed to be used in conjunction with a descender for maximum simplicity when setting up a deviation for a heavy load. The faceted sheave only rotates in one direction, providing excellent efficiency when hauling, and adding friction zones for the rope for additional braking when lowering. The swivel makes it easier to operate, allowing the pulley to be oriented under load and for carabiners, ropes, or slings to be directly connected.

 SPIN S1 and SPIN S1 OPEN pulleys



SPIN S1

Very high efficiency, compact single pulley with swivel

Possible to open, even when attached to the anchor, the SPIN S1 pulley is designed for maximum simplicity in setting up haul or load deviation systems and tensioned highlines. Compact, reducing weight and bulk, which is especially useful during technical rescue. The sheave mounted on sealed ball bearings provides excellent efficiency. The swivel makes it easier to operate, allowing the pulley to be oriented under load and for carabiners, ropes, or slings to be directly connected.



SPIN S1 OPEN

Very high-efficiency, compact single pulley with gated swivel

Possible to open, even when attached to the anchor, the SPIN S1 OPEN pulley is designed for maximum simplicity in setting up haul or load deviation systems and tensioned highlines. Compact, reducing weight and bulk, which is especially useful during technical rescue. The sheave mounted on sealed ball bearings provides excellent efficiency. The swivel facilitates operations, allowing the pulley to be oriented under load. The opening gate on the swivel makes the pulley compatible with a wide variety of products (tripod, REEVE pulley, PAW rigging plates, and more), reducing bulk during setup.

High-Efficiency Pulleys



PARTNER

Ultra-compact, high-efficiency pulley

The PARTNER is an ultra compact, extremely lightweight pulley. It is designed for daily tasks and on-site rescue.



RESCUE

High-strength, very high-efficiency pulley

The very high efficiency RESCUE pulley is designed for intensive use by rescue professionals.

Pulley-Carabiners



ROLLCLIP A

Pulley-carabiner that facilitates installation of the rope when pulley is connected to the anchor

ROLLCLIP A is a pulley-carabiner with the gate opening on the pulley end, to facilitate rope installation when the pulley is fixed to the anchor. It is available with an automatic TRIACT-LOCK locking system, or without a locking system. ROLLCLIP A can be used with a CAPTIV positioning bar to help orient the carabiner to load the major axis, limit the risk of rotation, and keep it integrated with the device.



ROLLCLIP Z

Pulley-carabiner that facilitates installation on anchors and devices

ROLLCLIP Z is a pulley-carabiner with the gate opening on the non-pulley end, to facilitate installation on anchors and devices. It is available in two locking systems: automatic TRIACT-LOCK system or manual SCREW-LOCK system.

Progress-Capture Pulleys



PRO TRAXION

Very high-efficiency, drop resistant progress-capture pulley with swivel

Possible to open, even when attached to the anchor, the PRO TRAXION progress-capture pulley is designed for setting up haul systems. With a large diameter sheave mounted on sealed ball bearings and excellent efficiency, it is particularly suitable for hauling heavy loads. The swivel makes it easier to operate, allowing the pulley to be oriented under load, and for carabiners, ropes, or slings to be directly connected.



MINI TRAXION

Compact and drop resistant high-efficiency progress-capture pulley

Possible to open, even when attached to the anchor, the MINI TRAXION progress-capture pulley is designed for setting up haul systems. With a medium-diameter sheave and great efficiency, it is particularly suitable for hauling mid-weight loads. It is compact, with minimized weight and bulk, which is especially useful during technical rescue and rope access work.



MINI TRAXION
Progress-Capture Pulley

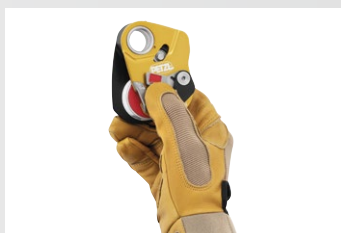

Triple-action opening of the moving side plate is quick and easy, even with gloves.

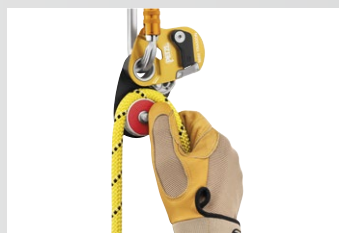

The rope can be installed in the MINI TRAXION pulley when it is connected to the anchor.



Pulleys

Prusik Pulleys



MINI

Highly efficient and lightweight Prusik pulley

The MINI compact pulley offers a lightweight solution for setting up progress-capture haul systems.



GEMINI

Highly efficient and lightweight double Prusik pulley

GEMINI is a compact double pulley for setting up progress-capture haul systems of high mechanical advantage.



MINDER

High strength, very high efficiency Prusik pulley

MINDER is a high-strength pulley designed for rescue professionals, or setting up progress-capture haul systems.



TWIN

High-strength, very high efficiency double Prusik pulley

TWIN is a high-strength double pulley designed for rescue professionals. It can be used to set up progress-capture haul systems of high mechanical advantage.

Single Pulleys



MOBILE

Versatile ultra-compact pulley

Compact and extremely lightweight, the MOBILE pulley is designed for a variety of uses.



FIXE

Versatile compact pulley

Versatile and compact, the FIXE pulley allows quick installation onto the rope.

Transport Pulleys



REEVE

Carriage pulley for rescue on a tensioned highline

Combining two pulleys and a rigging plate, the REEVE carriage pulley is an integrated solution designed to simplify setting up rescue systems on tensioned highlines. The compact design limits the number of connectors and the height of the system. Two large-diameter sheaves mounted on sealed ball bearings provide excellent efficiency when moving. Multiple connection holes to directly attach ropes, slings, or carabiners, allowing for better organization.



REEVE carriage pulley



Triple-action opening of the moving side plates is quick and easy, even with gloves.



Two red indicators provide a visual warning when the moving side plates are unlocked.



TANDEM® / TANDEM® SPEED

Double pulleys for tensioned highlines

TANDEM and TANDEM SPEED are designed for tensioned highlines on cables or ropes, and can accommodate up to three connectors to facilitate operations. TANDEM is used on a rope. TANDEM SPEED can also be used on a cable because of its wear resistant sheaves mounted on sealed ball bearings.



KOOTENAY

Knot-passing pulley

KOOTENAY is a knot-passing pulley that allows passage of joining knots. The large-diameter sheave mounted on sealed ball bearings provides excellent efficiency.



ROLLCAB

Roller for movement along cable

ROLLCAB is a roller designed for movement and evacuation along mechanical lift cables.

Haul System



JAG SYSTEM

Haul kit

The JAG SYSTEM haul kit is designed for pick-offs, making a releasable anchor, or tensioning a system, with a 4:1 mechanical advantage and excellent efficiency (sheaves with sealed ball bearings). The collapsed kit is highly compact, allowing it to be used even when the distance to the anchor is very short. The JAG SYSTEM haul kit is quick and easy to deploy: it is ready to use due to the flexible cover that helps prevent the risk of tangling. The haul end is color-coded for instant identification. It is available in three lengths: 1, 2, and 5 meters.



JAG TRAXION

High-efficiency double progress-capture pulley

The JAG TRAXION double progress-capture pulley is designed for use with the JAG pulley to make a 4:1 haul system. Sheaves with sealed ball bearings provide excellent efficiency.



JAG

High-efficiency double pulley

The JAG double pulley is designed for use with the JAG TRAXION double progress-capture pulley to make a 4:1 haul system. Sheaves with sealed ball bearings provide excellent efficiency.





TWIN RELEASE
progress-capture pulley

TWIN RELEASE

Releasable double progress-capture pulley for haul systems









Releasable, the TWIN RELEASE progress-capture pulley is designed to set up 4:1 haul systems for work in confined spaces or for technical rescue. It's possible to release the cam using the ergonomic handle. When lowering heavy loads, the brake integrated into the moving side plate and the main faceted sheave with single-direction rotation offer additional braking and better control. The two sheaves provide excellent hauling efficiency. The swivel makes it easier to operate, allowing the pulley to be oriented under load and for carabiners, ropes, or slings to be directly connected.



Release of the cam and passage of the rope through the brake integrated into the main moving side plate, allows comfortable and precise control when lowering.



The cam can be locked in the open position to make it easier to feed slack.

			Certifications	Rope Diameter Compatibility	Sheave Diameter	Ball Bearings	Efficiency	Working Load Limit	Weight
High-Efficiency Pulleys With Swivel									
SPIN L1		P001BA00 P001BA01 (1)	CE EN 12278 NFPA 2500 Pulley General Use UIAA	7 to 13 mm	38 mm	●	95%	4 x 2 = 8 kN	290 g
SPIN L2		P001CA00 P001CA01 (1)	XF 494: FZL-H-T9.5/13					8 kN (3)	480 g
SPIN L1D		P001AA00	CE (2) NFPA 2500 Pulley General Use	8 to 13 mm	40 mm	●	93%	3 x 2 = 6 kN	425 g
SPIN S1		P002AA00 P002AA01 (1)	CE EN 12278 NFPA 2500 Pulley Technical Use UIAA	7 to 11 mm	25 mm	●	91%	2,5 x 2 = 5 kN	145 g
SPIN S1 OPEN		P002BA00							160 g
High-Efficiency Pulleys									
PARTNER		P52A	CE EN 12278	7 to 11 mm	25 mm	●	91%	2,5 kN x 2 = 5 kN	56 g
RESCUE		P50A P50AN (1)	CE EN 12278 NFPA 2500 General Use XF 494: FZL-H-T 9.5/13	7 to 13 mm	38 mm	●	95%	4 kN x 2 = 8 kN	185 g
Pulley-Carabiners									
ROLLCLIP A		P74 TL	CE EN 362 EN 12275 EN 12278 EAC	7 to 13 mm	18 mm	●	85%	2 kN x 2 = 4 kN	115 g
		P74	CE EN 12275 EN 12278 EAC						105 g
ROLLCLIP Z		P75 TL	CE EN 362 EN 12278 EAC	7 to 13 mm	18 mm	●	85%	2 kN x 2 = 4 kN	110 g
		P75 SL							

			Certifications	Rope Diameter Compatibility	Sheave Diameter	Ball Bearings	Efficiency	Working Load Limit	Weight
Progress-Capture Pulleys									
PRO TRAXION		P055AA00	CE EN 567, EN 12278 EN 12841 type B NFPA 2500 Technical Use Pulley and Rope grab	8 to 13 mm	38 mm	●	95%	Pulley: 11.5 kN x 2 = 23 kN Rope clamp: 4 kN	295 g
MINI TRAXION		P054AA00		7 to 11 mm	32 mm	●	93%	Pulley: 10 kN x 2 = 20 kN Rope clamp: 4 kN	150 g
Prusik Pulleys									
MINI		P59A	CE EN 12278 NFPA 2500 Technical Use	7 to 11 mm	25 mm	●	91%	2,5 kN x 2 = 5 kN	80 g
GEMINI		P66A	CE EN 12278 NFPA 2500 Technical Use	7 to 11 mm	25 mm	●	91%	2 x 1,5 kN x 2 = 6 kN	135 g
MINDER		P60A	CE EN 12278 NFPA 2500 General Use	7 to 13 mm	51 mm	●	97%	4 kN x 2 = 8 kN	295 g
TWIN		P65A	CE EN 12278 NFPA 2500 General Use	7 to 13 mm	51 mm	●	97%	2 x 3 kN x 2 = 12 kN	450 g
Single Pulleys									
MOBILE		P03A	CE EN 12278	7 to 13 mm	21 mm	-	71%	2,5 kN x 2 = 5 kN	75 g
FIXE		P05W P05WN (1)	CE EN 12278	7 to 13 mm	21 mm	-	71%	2,5 kN x 2 = 5 kN	90 g
Transport Pulleys									
REEVE		P005AA00	CE EN 12278 NFPA 2500 General Use XF 494: FZL-H-T 9.5/13	7 to 13 mm	38 mm	●	95%	4 kN x 2 = 8 kN	650 g
TANDEM		P21	CE EN 12278	Rope ≤ 13 mm	21 mm	-	71%	10 kN	195 g
TANDEM SPEED		P21 SPE	CE EN 12278	Rope ≤ 13 mm	27,5 mm	●	95%	10 kN	270 g
KOOTENAY		P67	CE EN 12278 XF 404: FZL-H-Q 9.5/16	8 to 19 mm	76 mm	●	-	5 kN x 2 = 10 kN	1390 g
ROLLCAB		P47	CE EN 1909	Cable ≤ 55 mm	55 mm	-	-	5 kN	1470 g
Haul System									
JAG SYSTEM	1 m 2 m 5 m	P044AA00 P044AA01 P044AA02	EN 358 EAC	8 mm	-	●	91%	6 kN	610 g 805 g 1460 g
JAG TRAXION		P54	CE EN 567 NFPA 2500 Technical Use	8 to 11 mm	25 mm	●	91%	2 x 1,5 kN x 2 = 6 kN	145 g
JAG		P45	CE EN 12278 NFPA 2500 Technical Use	8 to 11 mm	25 mm	●	91%	2 x 1,5 kN x 2 = 6 kN	120 g
TWIN RELEASE		P001DA00	CE EN 567 EN 12278 (4) NFPA 2500 Pulley General Use NFPA 2500 Rope Grab Technical Use (5) XF 494: FZL-H-T 9.5/13 XF 494: FZL-Z-Q 9.5/13	8 to 13 mm	40 mm 38 mm	●	95%	280 kg	800 g

(1) Black pulleys, (2) CE based on the relevant requirements of the EN 12278 standard, (3) 3 kN per arm, more information in Instructions for Use, (4) partial CE EN 12278: meets performance requirements of the CE EN 12278 standard, (5) system certification: ANSI Z359.4 Synthetic Rope Tackle Block (more information in the Instructions for Use).



ANCHORS

Anchors are the link between the safety system and the structure or terrain. To complement the standard anchor equipment, Petzl offers a lifeline device specific to horizontal progression and a complete set of accessories.



Rock and Concrete Anchors

Elements that allow installation of temporary or permanent fixed anchors.



COEUR BOLT
STEEL



COEUR BOLT
STAINLESS



COEUR BOLT
HCR



COEUR PULSE
12 mm



COEUR
STEEL



COEUR
STAINLESS



COEUR
HCR



COLLINOX



BAT'INOX

Rigging Equipment

Swivels provide a solution to help prevent twisting and tangling ropes, especially when hauling. Rigging plates allow the workstation to be organized and increase the number of anchoring options. Rings allow multiple anchors to be organized.



MICRO SWIVEL



SWIVEL
OPEN



SWIVEL



PAW



RING



RING
OPEN

Anchor Slings and Straps

Slings and anchor straps designed for setting up temporary anchors.



ANNEAU



ST'ANNEAU



PUR'ANNEAU



CONNEXION
FIXE



CONNEXION
VARIO



WIRE
STROP

Quick-Adjustment Anchors



GRILLON



PROGRESS
ADJUST-H

Temporary Horizontal Lifeline

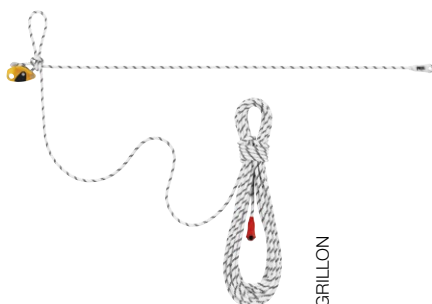

GRILLON

Anchor Straps for Tree Care

Friction savers for tree care.



EJECT



NAJA



TREESBEE



COEUR BOLT STEEL/STAINLESS/HCR

Anchors comprised of a COEUR hanger, a nut, and a bolt (pack of 20)



Different steels suited to various environments

Petzl anchors (hangers and bolts) use different types of steels to adapt the anchor to the environment in which it is used:

- Standard steel, designed for interior uses or non-permanent installations: **COEUR BOLT STEEL**
- 316L high quality stainless steel, designed for typical exterior uses: **COEUR BOLT STAINLESS**
- HCR 904 (High Corrosion Resistance) stainless steel, designed for ultra-corrosive environments: **COEUR BOLT HCR**

Hangers (COEUR STEEL, COEUR STAINLESS and COEUR HCR) and bolts (BOLT STEEL, BOLT STAINLESS, and BOLT HCR) are also available separately (pack of 20).



COEUR PULSE 12 mm

Removable anchor with locking function

The COEUR PULSE 12 mm is a removable, high-quality stainless steel anchor that can be installed and removed for reuse very simply and rapidly without tools. The locking function limits the risk of accidental removal. The COEUR hanger can rotate during installation and when laterally loaded during use, allowing it to better align with the systems in place.



How to install and inspect
COEUR PULSE anchors

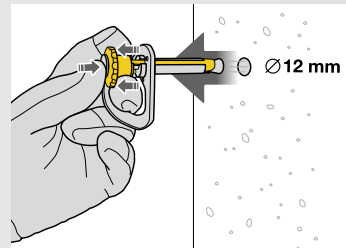

The anchor can be installed and removed for reuse very simply and rapidly, without tools.

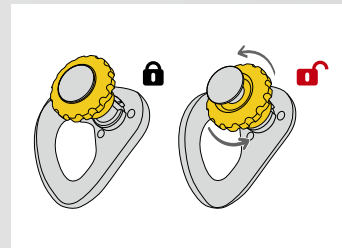

Manual screw-lock function limits the risk of involuntary removal.



COLLINOX

Forged stainless steel glue-in bolt (pack of 10)



AMPOULE COLLINOX

Resin glue for COLLINOX (pack of 10)



BAT'INOX

Forged stainless steel glue-in bolt (pack of 10)



AMPOULE BAT'INOX

Resin glue for BAT'INOX (pack of 10)



MICRO SWIVEL

Compact gated swivel

The compact, gated MICRO SWIVEL is designed for attachment to a locking carabiner. It helps prevent twisting of lanyards and allows correct positioning of devices. Its design without bearings allows it to turn freely when not loaded and to stop moving when loaded in order to hold the devices in position.



SWIVEL OPEN

Gated swivel with sealed ball bearings

The SWIVEL OPEN gated swivel features a large opening and can be attached to a wide range of products (such as pulleys or lanyards). It reduces the bulk and weight of component systems and solves the twisting and tangling problems of ropes and lanyards. Sealed ball bearings offer excellent performance and reliability.



SWIVEL

Ball bearing swivel

Available in two sizes, the SWIVEL prevents the rope from twisting when the load is turning. Sealed ball bearings offer excellent performance and reliability.



PAW

Rigging plate

Available in three sizes, the PAW rigging plate can be used to organize a workstation and set up multi-anchor systems. The hole design allows ropes or slings to be threaded for direct connection. Made of forged aluminum, it offers an excellent strength-to-weight ratio.



RING

Connection ring

The RING connection ring can be used to create multiple anchors or be installed directly onto the SEQUOIA and SEQUOIA SRT harnesses' attachment bridges to improve the arborist's lateral mobility.



RING OPEN

Multidirectional gated ring



Anchors

Anchor Slings and Straps

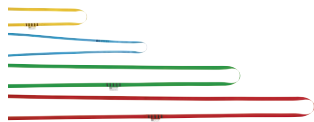

ANNEAU

Sewn sling

ANNEAU is an open loop sling available in four lengths, color-coded for easy identification of length.

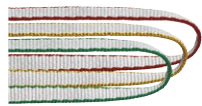

ST'ANNEAU

Lightweight sewn sling

ST'ANNEAU is a lightweight alternative to classic slings, available in three lengths, with color coding for easy identification of length.



PUR'ANNEAU

Ultra-light sewn sling

PUR'ANNEAU is a very lightweight sling with exceptional durability, thanks to its high-modulus polyethylene construction. It is particularly supple, for easy handling. Available in three lengths, color-coded for easy identification of length.



CONNEXION FIXE

Anchor strap

CONNEXION FIXE is a durable anchor strap with two forged steel attachment points. It offers several configurations for setting up an anchor: directly to an anchor point or around a suitable structure. It is available in three lengths: 100, 150, and 200 cm.



CONNEXION VARIO

Adjustable anchor strap

CONNEXION VARIO is a durable and adjustable anchor strap equipped with two forged steel attachment points. It offers several configurations for setting up an anchor: directly to an anchor point or around a suitable structure. The strap length can be adjusted using the adjustment buckle. A system keeps the remaining webbing stowed. It is available in two lengths: 30 to 200 cm and 200 to 400 cm.



WIRE STROP

Anchor strap

WIRE STROP is an anchor strap made of 6.5 mm diameter galvanized steel with two terminations of different sizes. It offers several configurations for setting up an anchor: directly to an anchor point or around a suitable structure. The plastic sheath helps hold the connector in position and facilitates clipping. It is available in five lengths (50, 100, 150, 200, and 300 cm).



Anchor strap with two terminations of different sizes. The plastic sheath helps hold the connector in position and facilitates clipping.

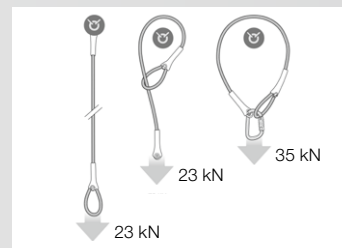

It offers several configurations for setting up an anchor: directly to an anchor point or around a suitable structure.

Quick-Adjustment Anchors



GRILLON Anchor

Quick-adjustment anchor

The adjustable GRILLON anchor can be used to quickly set a fixed anchor point. The length of rope required to set it is easily adjusted with the integrated self-locking device. The removable protective sheath allows smoother rope glide while protecting the rope from abrasive surfaces. It is available in four lengths.



PROGRESS ADJUST-I Anchor

Lightweight quick-adjustment anchor

Lightweight and compact, the PROGRESS ADJUST-I adjustable anchor can be used to quickly set up a fixed anchor point. The rope length required to set it up is easily adjusted with the ADJUST rope adjuster. The removable protective sheath protects the rope while enhancing rope glide. It is available in three lengths: 2, 3, and 5 m.

Temporary Horizontal Lifeline

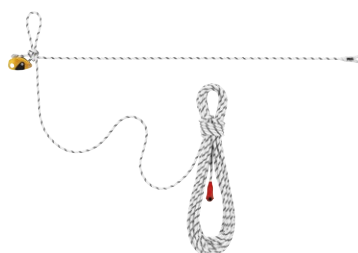

GRILLON Lifeline

Temporary horizontal lifeline

GRILLON allows a horizontal lifeline to be installed quickly when there is a large work area to cover. The integrated self-blocking device allows easy adjustment of length, depending on the distance between two anchor points. It is available in four lengths to adapt to a variety of different situations.



Anchor Straps for Tree Care

• Adjustable

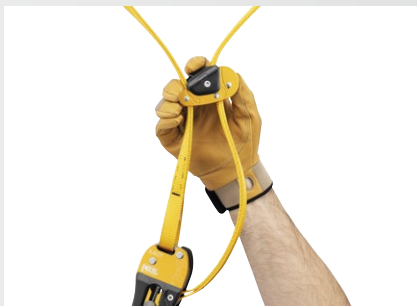

The EJECT and NAJA friction savers are adjustable so they can adapt to different branch diameters.

• Efficient



The EJECT and NAJA friction savers are both equipped with a pulley mounted on sealed ball bearings. This improves rope glide through the anchor and optimizes rope ascents and movement in the tree.

• Easily retrievable from the ground

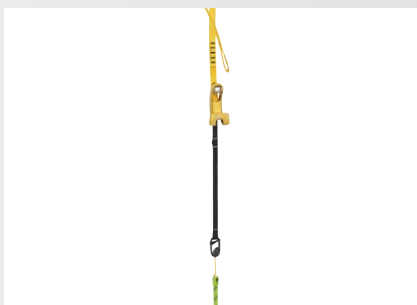

The EJECT and NAJA friction savers' thin construction reduces the risk of snagging during retrieval. The specially-designed retrieval balls make it easy to unlock the systems from the ground.

• EJECT: Adjustable friction saver with choking function

The adjuster on the EJECT friction saver allows you to precisely select the length of the strap to wrap or choke the tree trunk or branch. It is also possible to link two anchors for small branches. Unlocking the system is simple and quick, making it easy to retrieve from the ground.



EJECT adjustable friction saver

• NAJA: Friction saver featuring a strap with four different adjustment positions

The NAJA friction saver's adjustable strap has four different positioning loops, allowing you to better adapt to the diameter of the tree trunk or branch.



How to Use NAJA on a Single Rope (SRS)



How to Use NAJA on a Doubled Rope (MRS)

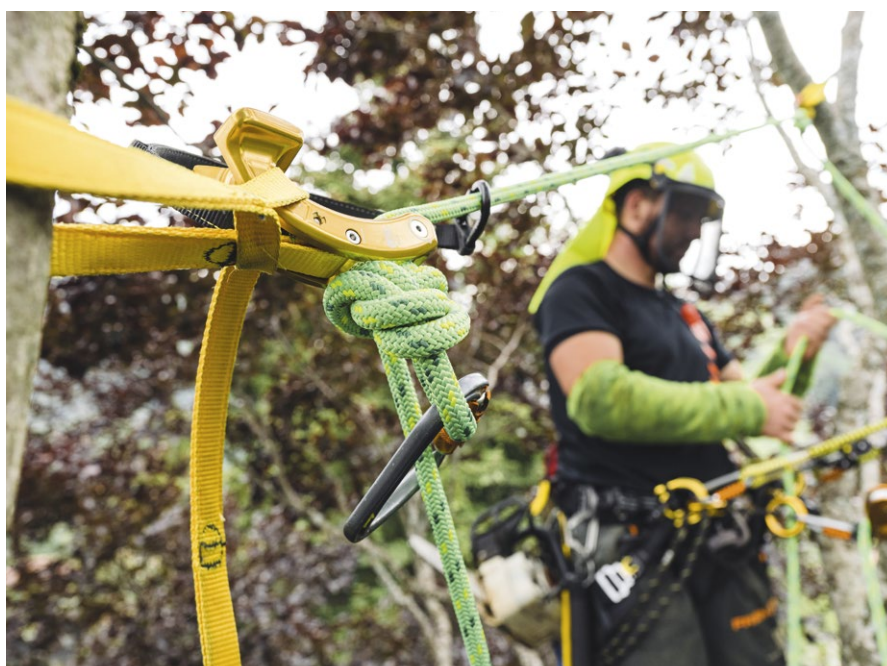



EJECT

Adjustable friction saver for tree care that is easily retrievable from the ground and has an integrated pulley and choking function

Designed for tree care, the EJECT friction saver allows the work rope to be set up without damaging the tree, even in narrow forks. It offers multiple setup configurations on one or two branches and has a choke adjuster that allows precise length adjustment of the friction saver. Rope ascents and movement in the tree are optimized with the very high-efficiency pulley, which facilitates rope glide at the anchor. The included retrieval ball makes the system easily retrievable from the ground.



Strap for EJECT

Strap for EJECT adjustable friction saver

This strap is specially designed for the EJECT adjustable friction saver. It can be used to replace the original strap or link two straps together to lengthen the friction saver and enable work on larger-diameter trees. It is available in two lengths: 150 and 250 cm.

Retrieval Ball for EJECT

Retrieval ball for EJECT adjustable friction saver

With a diameter of 21 mm, this retrieval ball is specially designed for the EJECT adjustable friction saver. It enables quick and easy system retrieval from the ground.



NAJA

Friction saver for tree care that is easily retrievable from the ground, with an integrated pulley and a strap with different adjustment positions

Designed for tree care, the NAJA friction saver allows the work rope to be set up without damaging the tree. The strap has four different adjustment positions to adapt to different branch diameters. Rope ascents and movement in the tree are optimized with the high-efficiency pulley, which facilitates rope glide at the anchor. The included retrieval ball makes the system easily retrievable from the ground.



Strap for NAJA

Strap for NAJA adjustable friction saver

This strap is specially designed for the NAJA adjustable friction saver. It can be used to replace the original strap or link two straps together to lengthen the friction saver and enable work on larger-diameter trees. It is available in two lengths: 150 and 250 cm.

Retrieval Ball for NAJA

Retrieval ball for NAJA adjustable friction saver

With a diameter of 21 mm, this retrieval ball is specially designed for the NAJA adjustable friction saver. It enables quick and easy system retrieval from the ground.



Anchor Straps for Tree Care



TREESBEE®

Friction saver for tree care, designed for ropes with spliced terminations

The TREESBEE anchor strap is used to improve rope glide at the anchor while protecting the tree from abrasion. It is designed for ropes with spliced terminations (the splice goes through the small ring). The galvanized steel rings provide great durability.

		Certifications	Diameters	Shear Strength in 50 MPa Concrete	Pull-Out Strength in 50 MPa Concrete	Weight
Rock and Concrete Anchors						
COEUR BOLT STEEL	P36BA 10	EN 959	10 mm	23 kN	15 kN	110 g
	P36BA 12		12 mm	25 kN	18 kN	135 g
COEUR BOLT STAINLESS	P36BS 10	EN 959	10 mm	25 kN	15 kN	110 g
	P36BS 12		12 mm		18 kN	135 g
COEUR BOLT HCR	P36BH 12	EN 959	12 mm	25 kN	18 kN	145 g
COEUR STEEL	P36AA 10	EN 795 A GB 30862/A	10 mm	-	-	65 g
	P36AA 12		12 mm	-	-	60 g
COEUR STAINLESS	P36AS 10	EN 795 A GB 30862/A	10 mm	-	-	65 g
	P36AS 12		12 mm	-	-	60 g
COEUR HCR	P36AH 12	EN 795 A, GB 30862/A	12 mm	-	-	60 g
COEUR PULSE 12 mm	G037BA00	CE EN 795 B, EN 959 TS 16415 GB 30862/B	12 mm	25 kN	20 kN	140 g
COLLINOX	G100AA00	EN 959	10 mm	25 kN	15 kN	95 g
AMPOULE COLLINOX	G101AA00	-	-	-	-	14 g
BAT'INOX	G102AA00	EN 959	14 mm	25 kN	15 kN	250 g
AMPOULE BAT'INOX	G103AA00	-	-	-	-	20 g

		Certifications	Breaking Strength	Weight
Rigging Equipment				
MICRO SWIVEL	P58 XSO	CE, EAC	23 kN	75 g
SWIVEL OPEN	P58 SO	CE NFPA 2500 Technical Use EAC	23 kN	130 g
SWIVEL	S P58 S	CE NFPA 2500 Technical Use EAC	23 kN	95 g
	L P58 L	CE NFPA 2500 General Use EAC	36 kN	150 g
PAW	S G063AA00/G063AA01 (1)	CE NFPA 2500 General Use	36 kN	60 g
	M G063BA00/G063BA01 (1)		45 kN	180 g
	L G063CA00/G063CA01 (1)		50 kN	350 g
RING	S C04620	CE	23 kN	40 g
	L C04630			70 g

		Certifications	Lengths	Breaking Strength	Weight
Anchor Slings and Straps					
ANNEAU	C40A 60/C40 60N (1)	CE EN 566 CE EN 795 B EAC GB 30862/B XF 494:FZL-B-Q	60 cm	22 kN	60 g
	C40A 80/C40 80N (1)		80 cm		80 g
	C40A 120/C40120 N (1)		120 cm		100 g
	C40A 150		150 cm		135 g
ST'ANNEAU	C07 24	CE EN 795 B GB 30862/B XF 494:FZL-B-Q	24 cm	22 kN	10 g
	C07 60		60 cm		20 g
	C07 120		120 cm		40 g
PUR'ANNEAU	G006AA00	CE EN 795 B GB 30862/B XF 494:FZL-B-Q	60 cm	22 kN	18 g
	G006AA01		120 cm		32 g
	G006AA02		180 cm		48 g
CONNEXION FIXE	G010AA00	CE EN 795 B NFPA 2500 General Use ANSI Z359.18 CSA Z259.15-17	100 cm	25 kN	355 g
	G010AA01		150 cm		415 g
	G010AA02		200 cm		475 g
CONNEXION VARIO	G011AA00		30 - 200 cm	25 kN	810 g
	G011AA01		200 - 400 cm		950 g
WIRE STROP	G200AA00		CE EN 795 B CE EN 354 TS 16415 (2) NFPA 2500 Technical Use ANSI Z359.18 GB 30862/B XF 494:FZL-B-Q	50 cm	23 kN
	G200AA01	100 cm		320 g	
	G200AA02	150 cm		420 g	
	G200AA03	200 cm		520 g	
	G200AA04	300 cm		720 g	
Quick-Adjustment Anchors and Temporary Horizontal Lifeline					
GRILLON Anchor GRILLON Lifeline	L052AA00	CE EN 795 B EAC GB 30862/B	2 m	-	480 g
	L052AA01		3 m	-	560 g
	L052AA02		4 m	-	640 g
	L052AA03		5 m	-	720 g
	L052AA04		10 m	-	1075 g
	L052AA05		15 m	-	1475 g
	L052AA06		20 m	-	1875 g
PROGRESS ADJUST-I Anchor	L044BA01	CE EN 795 B EAC GB 30862/B	2 m	-	300 g
	L044BA02		3 m	-	370 g
	L044BA03		5 m	-	510 g
Anchor Straps for Tree Care					
EJECT	G001AA00	CE EN 795 B, EN 12278 TS 16415, EAC	150 cm	25 kN	490 g
Strap for EJECT	G002AA00	-	150 cm	-	140 g
	G002AA01	-	250 cm	-	225 g
Retrieval Ball for EJECT	G003AA00	-	-	-	8 g
NAJA	G004AA00	CE EN 795 B, EN 12278 TS 16415	150 cm	25 kN	400 g
Strap for NAJA	G004BA00	-	150 cm	-	140 g
	G004BA01	-	250 cm	-	230 g
Retrieval Ball for NAJA	G004CA00	-	-	-	8 g
TREESBEE	G040AA00	CE EN 795 B TS 16415, EAC	90 cm	23 kN	420 g
	G040AA01		110 cm		440 g



ROPES

The line of Petzl ropes is designed for professionals in the vertical world.
They offer effective solutions for the requirements of various activities: rope access, technical rescue, industry.



Historical building maintenance and repair, Central Park, New York City, New York, USA © 2024 Petzl Distribution - Latouche - SPAR

Low Stretch Kernmantle Ropes

For Work at Height

Standard diameter low stretch kernmantle rope provides a good grip for easier handling.



AXIS 11 mm

For Rope Access

Low stretch kernmantle rope with small diameter provides very good performance in terms of flexibility and weight.



PARALLEL 10.5 mm

For Rescue

Low stretch kernmantle rope with a large diameter provides great strength and excellent handling when working with heavy loads.



BEAM 11 mm



VECTOR 12.5 mm

For Tree Care

Low stretch kernmantle rope with splice provides optimal performance when used with the ZIGZAG and ZIGZAG PLUS mechanical Prusiks.



FLOW 11.8 mm



CONTROL 12.5 mm

Static Ropes

For long descents, when intermediate anchors are not possible.

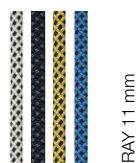

RAY 11 mm

Dynamic Rope

For progression using rock climbing techniques.



MAMBO 10.1 mm

Technical Cord

Cord for setting up Prusik hitches, anchors, or haul systems.



SEGMENT 8 mm

Accessory Cord

Cord for guiding a victim during rescue or for hauling equipment.

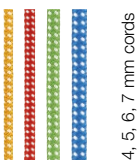

4, 5, 6, 7 mm cords

Rope Accessories

Professional rope accessories.



Identification Label for Petzl Ropes



Rope End Identification Kit

Rope Protectors

Devices that protect the rope at friction zones.

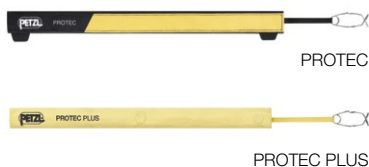

PROTEC

PROTEC PLUS



ROLLER COASTER



Low Stretch Kernmantle Ropes

A specific construction for each use and a choice of lengths and colors according to user needs.



- **EverFlex technology: provides flexibility and handling over time**

This technology provides great flexibility over time and under many different conditions (such as water, dust, and mud). The flexibility allows it to maintain consistent handling over the long run and perform optimally with devices.

- **Available in several lengths and colors**

Petzl low stretch kernmantle ropes come in several standard lengths, according to user needs and activities.



- **For work at height, rope access work and rescue**

They are also available in six colors for easy differentiation of kits, work ropes, safety ropes, and collective access ropes.



- **For tree care**

They are available in two colors, to differentiate working ropes from access ropes.

- **Petzl Custom for ropes**

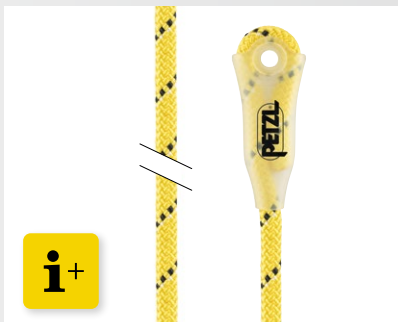

Petzl Custom allows you to choose:

- Rope color
- Rope length
- Type of termination (sewn or not, only on low stretch kernmantle ropes)

- **For work at height**

Standard diameter low stretch kernmantle rope provides a good grip and compatibility with most devices.

- **For rope access**

Low stretch kernmantle rope with small diameter provides very good performance in terms of flexibility and weight.

- **For rescue**

Low stretch kernmantle rope with medium to large diameter provides great strength and good handling when working with heavy loads.

∅ 11 mm

∅ 12,5 mm

- **For tree care**

Low stretch kernmantle rope with splice provides optimal performance when used with the ZIGZAG and ZIGZAG PLUS mechanical Prusiks.

∅ 11,8 mm

∅ 12,5 mm



AXIS 11 mm

Low stretch kernmantle rope with good handling for work at height

The AXIS 11 mm low stretch kernmantle rope is designed for work at height. The standard diameter provides a good grip for easier handling. Rope available in six colors and four lengths.



PARALLEL 10.5 mm

Low stretch kernmantle rope, flexible and lightweight for rope access

The PARALLEL 10.5 mm low stretch kernmantle rope is designed for rope access. The small diameter provides very good performance in terms of flexibility and weight. It has low elongation when under tension, increasing efficiency at the start of a rope ascent. Rope available in six colors and four lengths.

NEW
2025



BEAM 11 mm

High-strength, low stretch kernmantle rope with good handling for rescue

The BEAM 11 mm rope is designed for rescue professionals. Its diameter provides a solid grip and great strength. The specific rope construction limits compression and low elongation provides superior efficiency and comfort when handling heavy loads. EverFlex technology makes the rope highly flexible, providing excellent handling over time under a variety of conditions. The rope is available in four colors and four lengths.

NEW
2025



VECTOR 12.5 mm

High-strength, low stretch kernmantle rope with excellent handling for rescue

The VECTOR 12.5 mm rope is designed for rescue professionals. Its large diameter provides a solid grip and great strength. The specific rope construction limits compression and low elongation provides superior efficiency and comfort when handling heavy loads. EverFlex technology makes the rope highly flexible, providing excellent handling over time under a variety of conditions. The rope is available in six colors and four lengths.

NEW
2025



FLOW 11.8 mm

Flexible and lightweight low stretch kernmantle rope for tree care

The FLOW 11.8 mm low stretch kernmantle rope is designed for tree care. Its medium diameter provides great performance in terms of flexibility and weight. The rope's low elongation under load increases efficiency when moving in the tree. EverFlex technology provides great flexibility and handling over time. It comes with a splice at one or two ends, for optimal rope glide through devices like a friction saver or pulley, and through tree branches. With a small splice, the rope can pass through the friction chain of the ZIGZAG and ZIGZAG PLUS mechanical Prusiks. The rope is available in two colors and four lengths with one splice, and one length with two splices.

NEW
2025



CONTROL 12.5 mm

High-strength, low stretch kernmantle rope with excellent handling for tree care

The CONTROL 12.5 mm low stretch kernmantle rope is designed for tree care. The large diameter provides great strength and excellent grip. EverFlex technology provides great flexibility and excellent handling over time. It comes with a splice at one or two ends, for optimal rope glide through devices like a friction saver or pulley, and through tree branches. With a small splice, the rope can pass through the friction chain of the ZIGZAG and ZIGZAG PLUS mechanical Prusiks. The rope is available in two colors and three lengths with one splice, and one length with two splices.



Install a CONTROL rope in a ZIGZAG mechanical Prusik



Ropes

Static Ropes



RAY 11 mm

Static kernmantle rope with good grip for work at height and technical rescue

The RAY 11 mm static rope is designed for work at height and technical rescue involving long descents when intermediate anchors are not possible. It has low elongation under load for optimal precision during progression and positioning. The standard diameter provides a good grip for easier handling. EverFlex technology provides great flexibility and consistent performance over time. Rope available in four colors and four lengths.

Dynamic Rope



MAMBO® 10.1 mm

Dynamic rope for progression using climbing techniques

The 10.1 mm diameter MAMBO dynamic rope is designed for work at height professionals who use climbing techniques for progression. The thick sheath improves abrasion resistance.

Technical Cord



SEGMENT 8 mm

Technical cord

The SEGMENT 8 mm technical accessory cord is used when setting up Prusik hitches, anchors, or haul systems. EverFlex technology provides great flexibility and consistent performance over time. Cord available in three lengths.

Accessory Cord



Cords

Accessory cords

These rugged and durable cords are for guiding a victim during rescue or for hauling equipment. Available in four diameters, in a 120-meter roll.

Ropes for Mobile Fall Arresters



ASAP'AXIS 11 mm

Low stretch kernmantle rope with sewn termination and integrated energy dissipater, for use with an ASAP mobile fall arrester

The ASAP'AXIS 11 mm low stretch kernmantle rope with sewn termination and integrated energy dissipater is designed for use with an ASAP mobile fall arrester. The energy dissipater is integrated with the rope and meets the requirements of the European EN 353-2 standard for fall protection. The standard diameter provides a good grip for easier handling. EverFlex technology provides great flexibility and consistent performance over time. The sewn termination features the STUART accessory that helps keep the connector in position to facilitate handling. Rope available in six lengths.



AXIS 11 mm With Sewn Termination

Low stretch kernmantle rope with sewn termination for use with an ASAP LOCK mobile fall arrester

The AXIS 11 mm low stretch kernmantle rope with sewn termination is designed for use with an ASAP LOCK mobile fall arrester and an ASAP'SORBBER or ASAP'SORBBER AXESS energy absorber. It has a sewn termination with a protective sheath that helps keep the connector in position, allowing it to meet the requirements of the European EN 353-2 standard for fall protection. The standard diameter provides a good grip for easier handling. EverFlex technology provides great flexibility and consistent performance over time. Rope available in six lengths.



RAY 11 mm With Sewn Termination

(only available in the United States)

Static rope with sewn termination for use with ASAP and ASAP LOCK mobile fall arresters

The RAY 11 mm static rope with sewn termination is designed for use with an ASAP or ASAP LOCK mobile fall arrester. It has low elongation under load, allowing it to meet the requirements of the ANSI Z359.15 American fall protection standard. The standard diameter provides a good grip for easier handling. EverFlex technology provides great flexibility and consistent performance over time. The sewn termination with protective sheath helps keep the connector in position and makes handling easy. Rope available in five lengths.

Rope Accessories



Rope End Identification Kit

The rope end identification kit can be used to replace old labels or to identify individual ropes for professional uses. It contains twenty pre-printed labels and twenty heat-shrink sheaths compatible with 10.5 to 13 mm ropes.

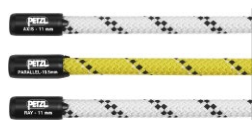

Identification Label for Petzl Ropes

Identification labels for marking Petzl professional ropes (pack of 10 pairs)

The identification labels can be used to replace old labels or establish a tracking system in order to more easily identify individual Petzl AXIS 11 mm, PARALLEL 10.5 mm, and RAY 11 mm ropes. They can quickly be installed on the end of the rope without using a tool. The labels are rigid, allowing for clear readability and longer-lasting markings.



Rope Protectors



PROTEC

Flexible protection for a fixed rope

The PROTEC flexible protector is designed to protect a fixed rope from abrasion when working at height or during rescue. Easy to install and durable, it's made for regular to intensive use. Versatile, PROTEC fits most rope diameters used by professionals, as well as anchor straps.

PROTEC PLUS

High-strength flexible protection for a fixed rope

With the help of its aramid construction, the PROTEC PLUS flexible protector is designed to protect a fixed rope from particularly abrasive surfaces or heat when working at height or during rescue. Easy to install and versatile, PROTEC PLUS fits most rope diameters used by professionals, as well as anchor straps.



ROLLER COASTER

Reversible rope protector on bearings for a moving rope





The ROLLER COASTER protector is designed to help protect a moving rope from abrasion. Reversible, with different frame shapes on either side that allow it to adapt to flat or angled surfaces. Multiple connection holes allow the use of different attachment methods. It's possible to connect multiple modules to better adapt to different types of terrain.



		Colors	Lengths	European Certification	U.S. Certifications	Russian Certification	Chinese Certification	Weight per Meter
Low Stretch Kernmantle Ropes								
AXIS 11 mm 	R074AA03	White	50 m	CE EN 1891 type A	ANSI Z459.1 NFPA 2500 Technical Use	EAC	XF 494	82 g
	R074AA04	Yellow						
	R074AA05	Black						
	R074AA38	Blue						
	R074AA39	Red						
	R074AA40	Orange						
	R074AA09	White	100 m					
	R074AA10	Yellow						
	R074AA11	Black						
	R074AA12	Blue						
	R074AA13	Red						
	R074AA14	Orange						
	R074AA21	White	200 m					
	R074AA22	Yellow						
	R074AA23	Black						
	R074AA24	Blue						
	R074AA25	Red						
	R074AA26	Orange						
	R074AA28	White	500 m					
	R074AA00	White	150 ft					
	R074AA01	Yellow						
	R074AA02	Black						
R074AA35	Blue							
R074AA36	Red							
R074AA37	Orange							
R074AA06	White	200 ft						
R074AA07	Yellow							
R074AA08	Black							
R074AA41	Blue							
R074AA42	Red							
R074AA43	Orange							
R074AA15	White	600 ft						
R074AA16	Yellow							
R074AA17	Black							
R074AA18	Blue							
R074AA19	Red							
R074AA20	Orange							
R074AA27	White	1200 ft						

		Colors	Lengths	European Certifications	U.S. Certifications	Russian Certification	Chinese Certification	Weight per Meter
Low Stretch Kernmantle Ropes								
PARALLEL 10.5 mm 	R077AA03	White	50 m	CE EN 1891 type A	NFPA 2500 Technical Use	EAC	XF 494	75 g
	R077AA04	Yellow						
	R077AA05	Black						
	R077AA35	Blue						
	R077AA36	Red						
	R077AA37	Orange						
	R077AA09	White						
	R077AA10	Yellow						
	R077AA11	Black						
	R077AA12	Blue						
	R077AA13	Red						
	R077AA14	Orange						
	R077AA21	White						
	R077AA22	Yellow						
R077AA23	Black							
R077AA24	Blue							
R077AA25	Red							
R077AA26	Orange							
R077AA28	White							
R077AA28	White							
R101CA00	White							
R101CA01	Yellow							
R101CA02	Blue							
R101CA03	Red							
R101CA04	White							
R101CA05	Yellow							
R101CA06	Blue							
R101CA07	Red							
R101CA08	White							
R101CA09	Yellow							
R101CA10	Blue							
R101CA11	Red							
R101CA12	White							
NEW 2025 BEAM 11 mm 	R101CA00	White	200 ft	CE EN 1891 type A	NFPA 2500 General Use Cordage Institute 1801 Low Stretch	-	XF 494	90 g
	R101CA01	Yellow						
	R101CA02	Blue						
	R101CA03	Red						
	R101CA04	White						
	R101CA05	Yellow						
	R101CA06	Blue						
	R101CA07	Red						
	R101CA08	White						
	R101CA09	Yellow						
	R101CA10	Blue						
	R101CA11	Red						
	R101CA12	White						
	R101CA12	White						
R101CA12	White							
NEW 2025 VECTOR 12.5 mm 	R078BA00	White	50 m	CE EN 1891 type A	NFPA 2500 General Use Cordage Institute 1801 Low Stretch	-	XF 494	113 g
	R078BA01	Yellow						
	R078BA02	Black						
	R078BA03	Blue						
	R078BA04	Red						
	R078BA05	Orange						
	R078BA06	White						
	R078BA07	Yellow						
	R078BA08	Black						
	R078BA09	Blue						
	R078BA10	Red						
	R078BA11	Orange						
	R078BA12	White						
	R078BA13	Yellow						
	R078BA14	Black						
	R078BA15	Blue						
	R078BA16	Red						
	R078BA17	Orange						
	R078BA18	White						
	R078CA00	White						
	R078CA01	Yellow						
	R078CA02	Black						
R078CA03	Blue							
R078CA04	Red							
R078CA05	Orange							
R078CA06	White							
R078CA07	Yellow							
R078CA08	Black							
R078CA09	Blue							
R078CA10	Red							
R078CA11	Orange							
R078CA12	White							
R078CA13	Yellow							
R078CA14	Black							
R078CA15	Blue							
R078CA16	Red							
R078CA17	Orange							
R078CA18	White							
R078CA18	White							
R078CA18	White							



Ropes

		Colors	Lengths	European Certifications	U.S. Certifications	Russian Certification	Chinese Certification	Weight per Meter
Low Stretch Kernmantle Ropes								
	1 splice			CE EN 1891 type A	ANSI Z133	-	-	103 g
	R079DA06	Green	25 m					
	R079DA07	Orange						
	R079DA00	Green	35 m					
	R079DA01	Orange						
	R079DA02	Green	45 m					
	R079DA03	Orange						
	R079DA04	Green	60 m					
	R079DA05	Orange						
	2 splices							
R079EA00	Green	45 m						
R079EA01	Orange							
	1 splice			CE EN 1891 type A	ANSI Z133	-	-	115 g
	R080EA00	Green	35 m					
	R080EA01	Orange						
	R080EA02	Green	45 m					
	R080EA03	Orange						
	R080EA04	Green	60 m					
	R080AB05	Orange						
	2 splices							
	R080DA00	Green	45 m					
	R080DA01	Orange						
Static Ropes								
	R100AA00	White	150 ft	-	ANSI Z359.15 ANSI Z459.1 NFPA 2500 Technical Use CI 1801	-	-	98 g
	R100AA01	Black						
	R100AA02	Yellow						
	R100AA03	Blue						
	R100AA04	White	200 ft					
	R100AA05	Black						
	R100AA06	Yellow						
	R100AA07	Blue						
	R100AA08	White	600 ft					
	R100AA09	Black						
	R100AA10	Yellow						
	R100AA11	Blue						
R100AA12	White	1200 ft						
Dynamic Rope								
	R32AC 050	Turquoise	50 m	CE EN 892 UIAA	-	-	GB/T 23268.1	65 g
	R32AD 050	Green						
	R32AC 060	Turquoise	60 m					
	R32AD 060	Green						
	R32AC 070	Turquoise	70 m					
	R32AD 070	Green						
Technical Cord								
	R076AA00	White	50 m	CE EN 564	NFPA 1983 Escape Use	-	-	43 g
	R076AA03		100 m					
	R076AA06		200 m					
Accessory Cord								
Cords	4 mm	R044AA00	Orange	CE EN 564	-	-	-	10 g
	5 mm	R045AA00	Red					15 g
	6 mm	R046AA00	Green					24 g
	7 mm	R047AA00	Blue					31 g

		Lengths	European Certifications	U.S. Certifications	Russian Certification	Chinese Certification	Weight per Meter
Ropes for Mobile Fall Arresters							
ASAP'AXIS 11 mm 	R074DA00	10 m	CE EN 1891 type A	-	-	-	82 g
	R074DA01	20 m					
	R074DA02	30 m					
	R074DA03	40 m					
	R074DA04	50 m					
	R074DA05	60 m					
AXIS 11 mm with sewn termination 	R074BA00	10 m	CE EN 1891 type A	NFPA 2500 Technical Use	EAC	XF 494 Light Use	82 g
	R074BA01	20 m					
	R074BA02	30 m					
	R074BA03	40 m					
	R074BA04	50 m					
	R074BA05	60 m					
RAY 11 mm with sewn termination 	R100BA00	25 ft	-	ANSI Z359.15 ANSI Z459 NFPA 2500	-	-	98 g
	R100BA01	50 ft					
	R100BA02	75 ft					
	R100BA03	100 ft					
	R100BA04	200 ft					

		Weight
Rope Accessories		
Rope End Identification Kit	R002AA00	-
Identification Label for Petzl Ropes	R004BA00 (AXIS 11mm)	-
	R004AA00 (PARALLEL 10.5 mm)	-
	R004CA00 (RAY 11 mm)	-

Rope Protectors		
PROTEC	R003AA00	130 g
PROTEC PLUS	R003BA00	135 g
ROLLER COASTER	R005AA00	470 g

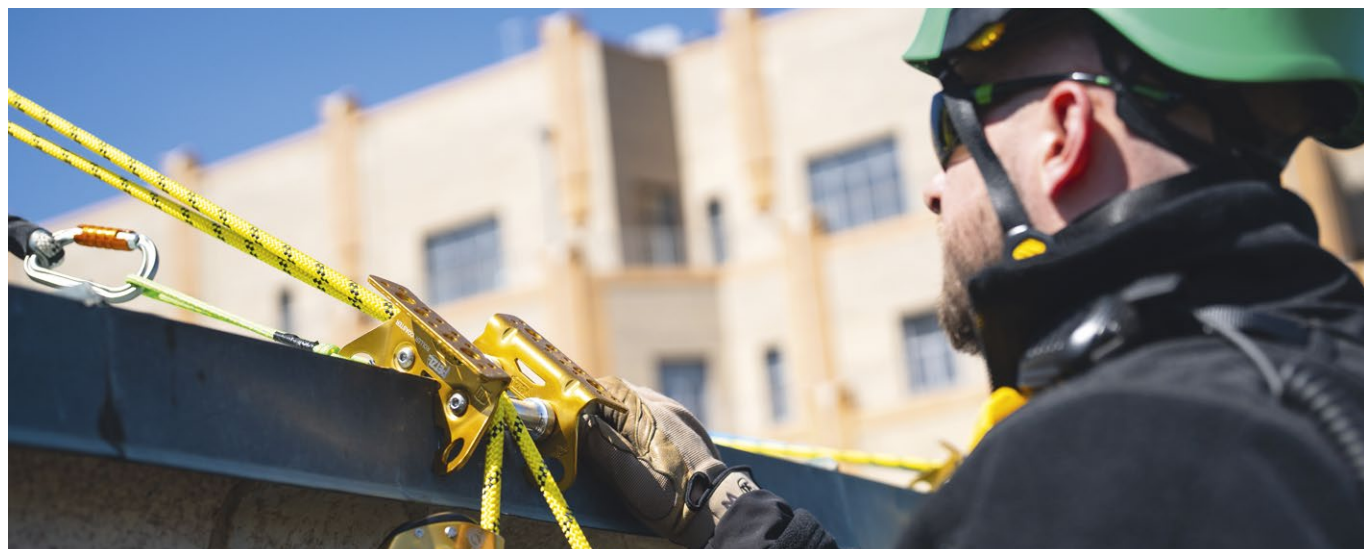

PACKS AND ACCESSORIES

To work comfortably, you need the right tools: packs, gloves, and accessories. Petzl offers an entire range of innovative accessories, the result of numerous years of experience in the field.



Transport Bags

Robust and comfortable, these large-capacity bags are designed for organizing and transporting equipment to the worksite.



Packs

Comfortable and durable, these large-capacity bags are designed for organizing and carrying equipment in a vertical environment.



Freestanding Bags

Even when empty, these bags maintain their shape when placed on the ground, for easy access to the equipment inside.



Tree Care Accessories

Specific products that help with placing an access rope in a tree.



Gloves

Protective gloves.



Accessories



Packs and Accessories

Transport Bags



DUFFEL 65



DUFFEL 85

DUFFEL 65/85

Transport bag

Designed to be carried on any means of transport, the DUFFEL bags are ergonomic and comfortable. Padded back and shoulder straps make them comfortable to carry as a backpack. Removable shoulder straps make these bags versatile, providing different carrying options. The large opening allows easy access to equipment, including two pockets in the inner flap and a large side pocket for a helmet or shoes. A large transparent area allows rapid identification of the bag. Constructed with high-strength TPU tarp material, these bags are built for intensive use. The DUFFEL bags are available in two sizes: 65 or 85 liters, and in two colors: yellow/black or black.



Large D-shaped opening for easy equipment organization.



Padded, adjustable back and shoulder straps for comfortable carrying.

Packs



TRANSPORT 30



TRANSPORT 45



TRANSPORT 60

TRANSPORT 30/45/60

Durable pack

Designed for regular to intensive use, the TRANSPORT packs are comfortable and durable. The back panel and shoulder straps are padded with thermoformed foam to optimize comfort, even when carrying heavy loads. They are constructed with high-strength TPU tarp material to withstand intensive use without premature wear. With a practical, freestanding design, they can also be hauled, hung open at a workstation, or carried using one of the three durable handles. The TRANSPORT 45 and TRANSPORT 60 have a waistbelt to distribute the weight of the pack. They are available in three sizes: 30, 45, or 60 liters, and in two colors: yellow/black or black.



Back panel and shoulder straps are padded with thermoformed foam to optimize comfort when carrying heavy loads.



TRANSPORT was designed to stay upright. The user can easily access their equipment, even when the pack is sitting open on the ground.



Let's go to work, New York City, New York, USA © 2024 Petzl Distribution - Vuedici.org - SPAR

Freestanding Bags



BUCKET 15



BUCKET 30



BUCKET 45

BUCKET 15/30/45

Freestanding bag

Simple and durable, BUCKET rope bags allow you to store up to 185 meters of 11 mm diameter rope. They're freestanding and keep their shape, even when empty, for easy access to the inside of the bag. They have an exterior pocket to store personal items and a marking area to quickly identify the contents of the bag. Made with TPU tarp material, they're designed to withstand regular to intensive use. The BUCKET 30 and BUCKET 45 are equipped with shoulder straps so they can be carried like a backpack. They are available in three sizes: 15, 30, or 45 liters, and in three colors: yellow, red, or black.



BUCKET bags can store 11 mm ropes:

- 45 meters of rope (BUCKET 15)
- 110 meters of rope (BUCKET 30)
- 185 meters of rope (BUCKET 45)



A roll top closure provides optimal protection against moisture.



How to Store Your Rope in the BUCKET Bag



TARP PRO

Large rope tarp

TARP PRO is a large rope tarp. It provides a 100 x 100 cm area to protect the rope from dust and dirt and can be quickly and easily stored in the BUCKET 30 or BUCKET 45 rope bags.



Packs and Accessories

Tree Care Accessories



JET

Throw-bag

Double-layer construction gives the JET throw-bag excellent longevity. Streamlined shape facilitates passage through tree branches. It is available in three versions: 250, 300, and 350 g.



AIRLINE

Throw-line

The AIRLINE throw-line offers an excellent compromise between flexibility and rigidity, for an accurate throw without the formation of knots as it comes out of the bag. The excellent sheath-core bond maintains a round cross section, providing good rope glide through the tree. It is available in two lengths: 60 and 300 meters.



ECLIPSE

Storage for throw-line

ECLIPSE provides easy storage for AIRLINE throw-lines and JET throw-bags. The double bottom allows two throw-lines to be stored separately. Once folded into the small bag, it all fits perfectly into the BUCKET.

JET throw-bag



WARNING
for California
Residents

This product can expose you to chemicals including lead, which is known to the State of California to cause cancer, birth defects or other reproductive harm. For more information, go to www.P65Warnings.ca.gov

Gloves



CORDEX

Lightweight belay/rappel gloves

These lightweight belay/rappel gloves combine the durability of a work glove with the precise fit and dexterity of a thinner glove. Double-layered leather protects the palm and other high-wear areas. The back is made of abrasion resistant, breathable stretch nylon, providing comfort and fit. The low profile neoprene cuff with Velcro closure features a reinforced carabiner hole for attaching the gloves to your harness.



CORDEX PLUS

Belay/rappel gloves

These medium weight belay/rappel gloves offer extra protection without sacrificing dexterity. Double-layer leather and padding protect the palm from heat generated during long rappels or lowers. Fingertips and other high-wear areas are reinforced for increased durability. The back is made of leather with abrasion resistant stretch nylon at key flex areas. The low profile neoprene cuff with Velcro closure features a reinforced carabiner hole for attaching the gloves to your harness.

CORDEX and CORDEX PLUS gloves



WARNING
for California
Residents

This product can expose you to chemicals including hexavalent chromium, which is known to the State of California to cause cancer, birth defects or other reproductive harm. For more information, go to www.P65Warnings.ca.gov

Accessories



MINO

Non-PPE accessory carabiner

MINO is a small, lightweight accessory carabiner ideal for hanging accessories on your harness. It is ergonomic and easy to use, even with gloves. MINO is sold individually or with two additional accessories (CAPTIV-type anti-rotation bar and LOCK-type locking bar). This product is not PPE (Personal Protective Equipment).



SPATHA

Clippable knife

The SPATHA knife is designed to accompany the worker at height during all daily tasks. The profile of the blade allows easy cutting of ropes and cords. It has a carabiner hole for easily attaching the knife to the harness. It is easy to manipulate with its textured wheel, even when wearing gloves, and can be locked in the open position.



CRAB 6

6-point crampons

Six-point crampons, adaptable to all shoe sizes, used for moving over talus and snow- and ice-covered slopes.

		Colors		Capacity	Weight		
Transport Bags							
DUFFEL 65		S045AA00	Yellow/Black	65 l	1350 g		
		S045AA02	Black				
DUFFEL 85		S045AA01	Yellow/Black	85 l	1550 g		
		S045AA03	Black				
Packs							
TRANSPORT 30		S042AA00	Yellow/Black	30 l	1300 g		
		S042AA01	Black				
TRANSPORT 45		S042BA00	Yellow/Black	45 l	1530 g		
		S042BA01	Black				
TRANSPORT 60		S042CA00	Yellow/Black	60 l	1780 g		
		S042CA01	Black				
Freestanding Bags							
BUCKET 15		S001AA00	Yellow	15 l	465 g		
		S001BA00	Red				
		S001CA00	Black				
BUCKET 30		S001AA01	Yellow	30 l	735 g		
		S001BA01	Red				
		S001CA01	Black				
BUCKET 45		S001AA02	Yellow	45 l	890 g		
		S001BA02	Red				
		S001CA02	Black				
TARP PRO		S001DA00	-	-	210 g		
Tree Care Accessories							
JET		S02Y 250	-	-	250 g		
		S02Y 300	-	-	300g		
		S02Y 350	-	-	350 g		
AIRLINE		R02Y 060	-	-	2,1 g/m		
		R02Y 300	-	-	2,1 g/m		
ECLIPSE		S03Y	-	-	500 g		
		Sizes		Hand Circumference	Colors	Certifications	
Gloves							
CORDEX		K52 SN	S	8	20 cm	Black	CE EN 21420 EN 388 (3123) EAC
		K52 MN	M	8,5	21,5 cm		
		K52 LN	L	9	23 cm		
		K52 XLN	XL	9,5	24,5 cm		
		K52 XST	XS	7,5	19 cm	Beige	
		K52 ST	S	8	20 cm		
		K52 MT	M	8,5	21,5 cm		
		K52 LT	L	9	23 cm		
CORDEX PLUS		K53 SN	S	8	20 cm	Black	CE EN 21420 EN 388 (3123) EAC
		K53 MN	M	8,5	21,5 cm		
		K53 LN	L	9	23 cm		
		K53 XLN	XL	9,5	24,5 cm		
		K53 XST	XS	7,5	19 cm	Beige	
		K53 ST	S	8	20 cm		
		K53 MT	M	8,5	21,5 cm		
		K53 LT	L	9	23 cm		
			K53 XLT	XL	9,5	24,5 cm	
Accessories							
MINO	M007AA00 (no accessory)		M007BA00 (with accessories)				
SPATHA	S92AN						
CRAB 6	64160						



KITS

Helping users to easily get equipped or to update their equipment, Petzl proposes kits for installing a temporary vertical lifeline, protecting falls, work positioning, or evacuating a victim.



Customizable Temporary Vertical Lifelines and Fall-Arrest Kits

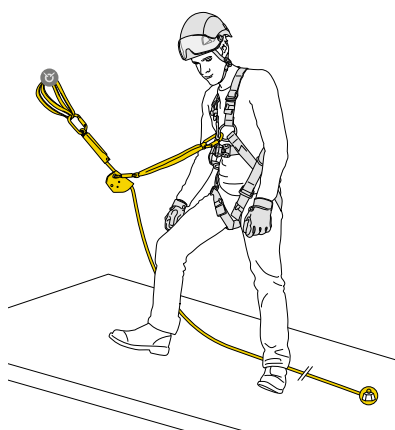

ASAP® VERTICAL LIFELINE

Vertical lifeline for protection against falls with ASAP mobile fall arrester

ASAP VERTICAL LIFELINE is a temporary vertical lifeline designed for belaying and to protect against falls from height. It contains an ASAP mobile fall arrester, an ASAP'SORBBER energy absorber, three OK TRIACT-LOCK carabiners, an ANNEAU open loop sling, an ASAP'AXIS 11 mm rope with sewn termination and integrated energy dissipater, a weight, and a BUCKET bag. It is available in two lengths.

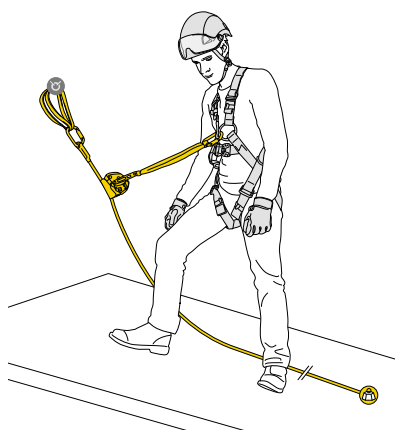

ASAP® LOCK VERTICAL LIFELINE

Vertical lifeline for protection against falls with ASAP LOCK mobile fall arrester

ASAP LOCK VERTICAL LIFELINE is a temporary vertical lifeline designed for belaying and to protect against falls from height. It contains an ASAP LOCK mobile fall arrester with locking function, an ASAP'SORBBER energy absorber, two OK TRIACT-LOCK carabiners, an ANNEAU open loop sling, an AXIS 11 mm rope with sewn termination, a weight, and a BUCKET bag. It is available in two lengths.

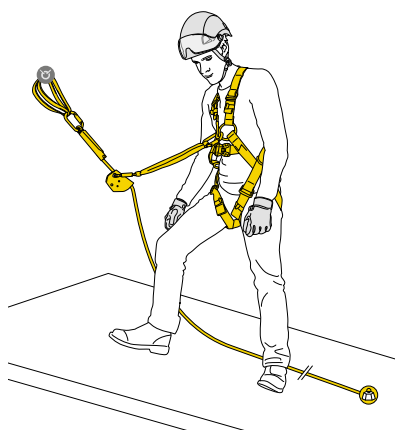

ASAP® FALL ARREST KIT

Kit for protection against falls, with NEWTON harness and ASAP mobile fall arrester

ASAP FALL ARREST KIT is a ready-to-use kit designed to protect against falls from height. It contains a NEWTON fall-arrest harness, an ASAP mobile fall arrester, an ASAP'SORBBER energy absorber, three OK TRIACT-LOCK carabiners, an ANNEAU open loop sling, an ASAP'AXIS 11 mm rope with sewn termination and integrated energy dissipater, a weight, and a BUCKET bag. The kit is available in two sizes and two lengths.

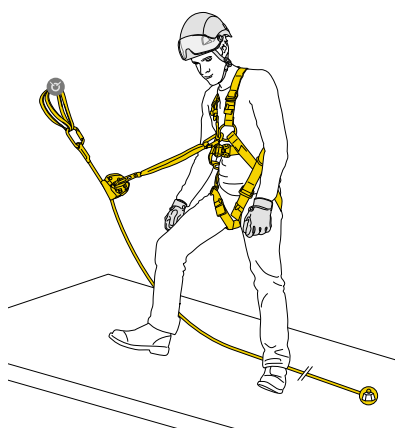

ASAP® LOCK FALL ARREST KIT

Kit for protection against falls, with NEWTON harness and ASAP LOCK mobile fall arrester

ASAP LOCK FALL ARREST KIT is a ready-to-use kit designed to protect against falls from height. It contains a NEWTON fall-arrest harness, an ASAP LOCK mobile fall arrester with locking function, an ASAP'SORBBER energy absorber, two OK TRIACT-LOCK carabiners, an ANNEAU open loop sling, an AXIS 11 mm rope with sewn termination, a weight, and a BUCKET bag. The kit is available in two sizes and two lengths.



How to use the ASAP and ASAP LOCK on a lifeline



Fall-Arrest Kit

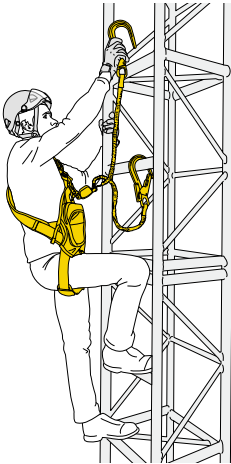

ABSORBICA®-Y FALL ARREST KIT

Kit for protection against falls, with NEWTON EASYFIT harness and ABSORBICA-Y MGO 150 lanyard

ABSORBICA-Y FALL ARREST KIT is a ready-to-use kit designed for fall protection. It is optimized for work at height requiring connection to metal structures or large-diameter cables and bars. The kit contains a NEWTON EASYFIT fall-arrest harness, a 150 cm ABSORBICA-Y double lanyard with energy absorber and MGO large-opening connectors, and a BUCKET bag. It is available in two sizes.

Fall-Arrest and Work-Positioning Kit

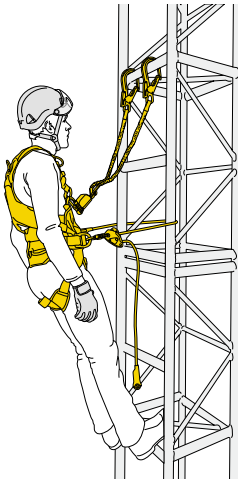

FALL ARREST AND WORK POSITIONING KIT

Fall-arrest and work-positioning kit with VOLT harness, ABSORBICA-Y MGO 150 lanyard, and GRILLON HOOK

FALL ARREST AND WORK POSITIONING KIT is a ready-to-use kit designed to protect against falls and for positioning at a workstation. It is optimized for work at height requiring connection to metal structures or large-diameter cables and bars. The kit contains a VOLT fall-arrest and work-positioning harness, a 150 cm ABSORBICA-Y double lanyard with energy absorber and MGO large-opening connectors, a 2-meter GRILLON HOOK adjustable work-positioning lanyard, an OK TRIACT-LOCK carabiner, a CAPTIV positioning bar, and a BUCKET bag. It is available in two sizes.

Rescue Kit

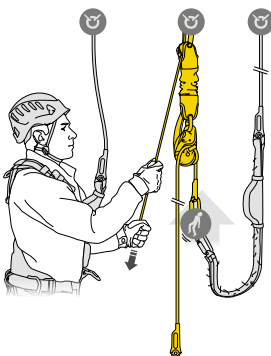

JAG RESCUE KIT

Reversible rescue kit with JAG SYSTEM haul kit and I'D EVAC descender

The JAG RESCUE KIT is a ready-to-use reversible rescue kit designed to easily pick off and lower a victim. It contains a JAG SYSTEM haul kit, a RING OPEN gated ring, an I'D EVAC descender with integrated brake, a CONNEXION FIXE 150 cm anchor strap, a BUCKET bag, and an AXIS 11 mm rope with two sewn terminations. It is available in three lengths: 30, 60, and 120 m.



CUSTOM

Available in
Custom version

		Contents of Kit	Harness Size	Rope Length	Weight
Temporary Vertical Lifelines and Fall-Arrest Kits					
ASAP VERTICAL LIFELINE	K091AB00	ASAP ASAP'SORBBER 40 cm OK TRIACT-LOCK (x3) ANNEAU 150 cm AXIS 11 mm rope with sewn termination and integrated energy dissipater	-	10 m	2485 g
	K091AB01	A 400 g weight BUCKET 30		20 m	3285 g
ASAP LOCK VERTICAL LIFELINE	K092AA00	ASAP LOCK ASAP'SORBBER 40 cm OK TRIACT-LOCK (x2) ANNEAU 150 cm AXIS 11 mm With Sewn Termination	-	10 m	2615 g
	K092AA01	A 400 g weight BUCKET 30		20 m	3415 g
ASAP FALL ARREST KIT	K093AB00	NEWTON European Version ASAP ASAP'SORBBER 40 cm OK TRIACT-LOCK (x3) ANNEAU 150 cm AXIS 11 mm rope with sewn termination and integrated energy dissipater	1	10 m	3535 g
	K093AB01		2	10 m	3565 g
	K093AB02		1	20 m	4335 g
	K093AB03		2	20 m	4365 g
ASAP LOCK FALL ARREST KIT	K094AA00	NEWTON European Version ASAP LOCK ASAP'SORBBER 40 cm OK TRIACT-LOCK (x2) ANNEAU 150 cm AXIS 11 mm With Sewn Termination	1	10 m	3665 g
	K094AA01		2	10 m	3695 g
	K094AA02		1	20 m	4465 g
	K094AA03		2	20 m	4495 g
ABSORBICA-Y FALL ARREST KIT	K095AC00	NEWTON EASYFIT International Version ABSORBICA-Y MGO 150 European Version BUCKET 30	1	-	3445 g
	K095AC01		2		3495 g
Fall-Arrest and Work-Positioning Kit					
FALL ARREST AND WORK POSITIONING KIT	K096AB00	VOLT ABSORBICA-Y MGO 150 European Version GRILLON HOOK European Version 2 m OK TRIACT-LOCK CAPTIV BUCKET 30	1	-	4795 g
	K096AB01		2		4875 g
Rescue Kit					
JAG RESCUE KIT	K090AA00	JAG SYSTEM RING OPEN I'D EVAC CONNEXION FIXE 150 cm AXIS 11 mm rope with two sewn terminations BUCKET 30 or BUCKET 45	-	30 m	4460 g
	K090AA01		-	60 m	6760 g
	K090AA02		-	120 m	11460 g





CUSTOMIZABLE PRODUCTS



With Petzl Custom, you can customize certain Petzl products. We're able to manufacture and assemble ready-made products to meet specific user needs or to customize a product with a company's colors or logo, for example. To take advantage of Petzl Custom, simply contact your Petzl representative and place your order.



Customizable Helmets



VERTEX CUSTOM



STRATO CUSTOM

Customizable Work-Positioning Lanyard



GRILLON CUSTOM

Customizable Kit



JAG RESCUE KIT CUSTOM

Customizable Personal Escape System



EXO CUSTOM

Customizable Ropes and Cords



SEGMENT 8 mm CUSTOM



PARALLEL 10.5 mm CUSTOM



DURALINE 10.5 mm CUSTOM



AXIS 11 mm CUSTOM



RAY 11 mm CUSTOM



VECTOR 12.5 mm CUSTOM

NEW 2025

Customizable Helmets



VERTEX® CUSTOM

Customizable helmet from the VERTEX range

Petzl Custom offers customized helmets from the VERTEX range. There is a choice of shell (with or without ventilation) and of color (standard or fluorescent). Stickers with a logo and/or names can be printed, and colored reflective bands may be added. A wide range of accessories (chinstraps, protective eye and face shields, helmet protectors, nape protectors, name-tag holders, beanies) are available and may be pre-mounted. They are packaged individually for a ready-to-go solution. Minimum order quantity: 20 units.



STRATO® CUSTOM

Customizable helmet from the STRATO range

Petzl Custom can customize one of the helmets in the STRATO range. There is a choice of shell (with or without ventilation) and of color (standard or fluorescent). Stickers with a logo and/or names can be printed, and colored reflective bands may be added. A wide range of accessories (chinstraps, protective eye and face shields, helmet protectors, nape protectors, name-tag holders, beanies) are available and may be pre-mounted. They are packaged individually for a ready-to-go solution. Minimum order quantity: 20 units.





Customizable Work-Positioning Lanyard



GRILLON CUSTOM

Customizable work-positioning lanyard

Petzl Custom can customize a work-positioning lanyard from the GRILLON range. You can choose the type of rope (standard or high-strength), the color, and the length (up to 20 meters). You can also choose the color of the device. The lanyard can be equipped with connectors for attachment to the harness or for the end. The GRILLON CUSTOM lanyard is packaged individually for a ready-to-go solution. GRILLON CUSTOM replacement ropes are also available individually.

Customizable Kit



JAG RESCUE KIT CUSTOM

Reversible and customizable rescue kit with JAG SYSTEM haul kit and I'D descender

Petzl Custom allows you to customize a JAG RESCUE KIT. Choice of color and length are offered for the AXIS 11 mm rope, from 10 to 185 meters. You can also choose anchor type, haul kit length, and either the I'D S or I'D EVAC self-braking descender with anti-panic function. The kit is delivered in a bag that corresponds to the selected rope length for a ready-to-go solution.

Customizable Personal Escape System



EXO® CUSTOM

Customizable personal escape system

Petzl Custom offers customized EXO personal escape systems. Choice of rope color and length, up to 150 meters, are available. You can also choose a descender with or without anti-panic function. The system can be equipped with connectors for attachment to the anchor and to the harness. The EXO CUSTOM personal escape system can be delivered in a bag for a ready-to-go solution. EXO CUSTOM replacement ropes are also available individually.

Customizable Ropes and Cords



SEGMENT 8 mm CUSTOM

Customizable technical cord

Petzl Custom offers customized SEGMENT cords. We offer the choice of length (up to 2000 meters) and the option to add a manufactured sewn termination to one or both ends. The SEGMENT 8 mm CUSTOM cord is packaged individually for a ready-to-go solution.



PARALLEL 10.5 mm CUSTOM

Customizable low stretch kernmantle rope for rope access

Petzl Custom can customize a PARALLEL 10.5 mm rope. We offer the choice of color, length (up to 700 meters), and the option to add a manufactured sewn termination to one or both ends. Markings at the end of the rope can also be customized with a heat-shrink cover or laser-marked rigid identification label. The PARALLEL 10.5 mm CUSTOM rope is packaged individually for a ready-to-go solution.



DURALINE 10.5 mm CUSTOM

High-strength, low stretch kernmantle rope that is customizable and made for work at height, rope access, and rescue

The DURALINE 10.5 mm CUSTOM low stretch kernmantle rope is designed for work at height, rope access, and rescue. Its aramid fiber sheath provides better resistance to abrasion, wear, and heat, than a classic rope. The thin diameter makes it flexible and lightweight. It's equipped with a rigid identification label on the end of the rope for better tracking and durability. The length and packaging are customizable to meet the needs of the user.



AXIS 11 mm CUSTOM

Customizable low stretch kernmantle rope for work at height

Petzl Custom can customize an AXIS 11 mm rope. We offer the choice of color, length (up to 700 meters), and the option to add a manufactured sewn termination to one or both ends. Markings at the end of the rope can also be customized with a heat-shrink cover or laser-marked rigid identification label. The AXIS 11 mm CUSTOM rope is packaged individually for a ready-to-go solution.



RAY 11 mm CUSTOM

Customizable static kernmantle rope for work at height and technical rescue

Petzl Custom can customize a RAY 11 mm rope. We offer the choice of color, length (up to 500 meters), and the option to add a manufactured sewn termination to one or both ends. The RAY 11 mm CUSTOM rope is packaged individually for a ready-to-go solution.



NEW
2025

VECTOR 12.5 mm CUSTOM

Customizable, high-strength, low stretch kernmantle rope with excellent handling for rescue

Petzl Custom can customize a VECTOR 12.5 mm rope. We offer the choice of color, length (up to 500 meters), and the option to add a manufactured sewn termination to one or both ends. The VECTOR 12.5 mm CUSTOM rope is packaged individually for a ready-to-go solution.

	References
VERTEX CUSTOM	A010XY
STRATO CUSTOM	A020XY
GRILLON CUSTOM	L052XYXX
JAG RESCUE KIT CUSTOM	K090XY
EXO CUSTOM	D030XYXX
SEGMENT 8 mm CUSTOM	R076DA
PARALLEL 10.5 mm CUSTOM	R077XY
DURALINE 10.5 mm CUSTOM	R075XY
AXIS 11 mm CUSTOM	R074XY
RAY 11 mm CUSTOM	R100XY
NEW 2025 VECTOR 12.5 mm CUSTOM	R078XY01



LIGHTING





A Range for Every Use

The Petzl headlamp range covers the full spectrum of professional needs, from intensive to occasional use, and for different work environments that require varying degrees of brightness.

Professions	Industry, Maintenance, Inspection, and Rescue	Industry, Energy and Networks, Construction, Maintenance	Workshop, Maintenance, and Stage Work
Frequency of Use	Intensive	Frequent	Occasional to Frequent
User Needs	<ul style="list-style-type: none"> - Very powerful, intelligent lighting - Long burn time - Durable - Waterproof (except SWIFT RL) 	<ul style="list-style-type: none"> - Durable and chemical resistant - Water resistant - Easy to use with gloves - Helmet mounting plate included - Consistent lighting 	<ul style="list-style-type: none"> - Lightweight and compact - Durability and water resistance - Easy to use - RGB lighting (RGB versions)
Petzl Solutions	<p>Powerful and Intelligent Headlamps</p>  <p>DUO RL</p>  <p>XENA</p>  <p>SWIFT RL</p>	<p>Compact and Durable Headlamps</p>  <p>PIXA R</p>  <p>PIXA</p>  <p>PIXA Z0</p>	<p>Ultra-Compact and Versatile Headlamps</p>  <p>ARIA 2R</p>  <p>ARIA 1R</p>  <p>ARIA 2</p>  <p>ARIA 2 RGB</p>  <p>ARIA 1</p>  <p>ARIA 1 RGB</p> <hr/> <p>Emergency Headlamp</p>  <p>e+LITE</p>

Intelligent lighting for greater convenience and performance

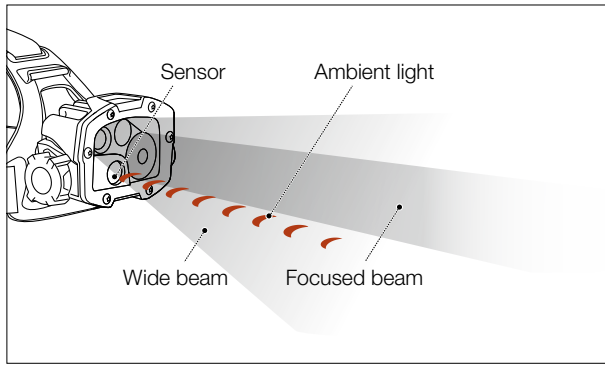

This exclusive technology developed by Petzl instantly provides the right lighting at the right time, without any need for manual operation. Burn time is optimized so you can remain focused on the activity.

REACTIVE LIGHTING technology offers:

- Intelligent lighting
- Hands-free lighting for greater convenience and performance
- Longer burn time



This feature is available in DUO RL and SWIFT RL headlamps.

Choose the battery type that fits your needs

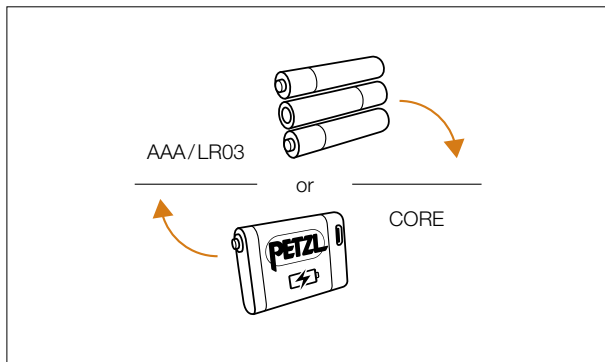

The HYBRID CONCEPT design allows Petzl's compact headlamps to run on either the CORE rechargeable battery or three AAA/LR03 batteries without an adapter.

- CORE rechargeable battery is an economical solution for frequent and/or intensive use
- AAA/LR03 batteries for occasional use with very long burn time



This feature is available in the ARIA and PIXA headlamp ranges.

Compatible with a variety of helmet types

All Petzl headlamps are designed to be worn on the head or a helmet, and allow the headlamp to be tilted:

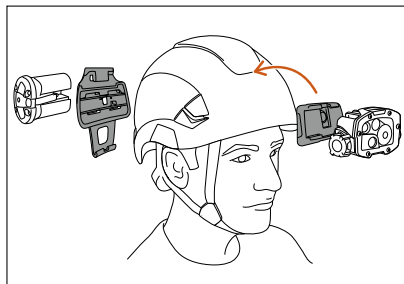

- On Petzl helmets, using their mounting plates

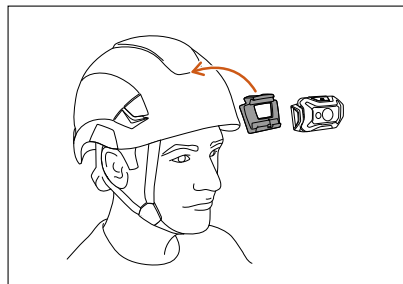

- On Petzl helmets, using specific mounting plates that are available as accessories

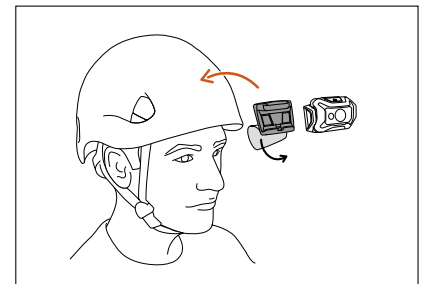

- On other helmets, using adhesive plates that are available as accessories



Brightness and Burn Time

A Question of Balance

Brightness and burn time are two inextricably linked parameters of any headlamp, regardless of its lighting technology. For a given quantity of energy, increasing the brightness automatically decreases burn time, and vice versa.

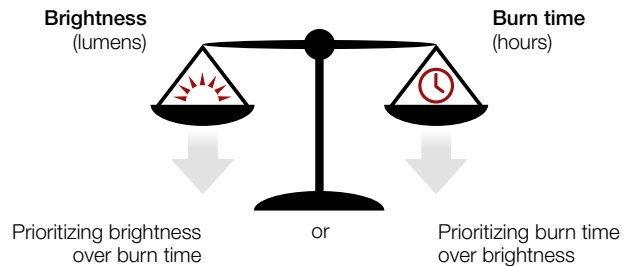

Different Lighting Technologies



Prioritizing burn time: STANDARD LIGHTING

Brightness decreases gradually as the batteries are drained. It is the most common technology.

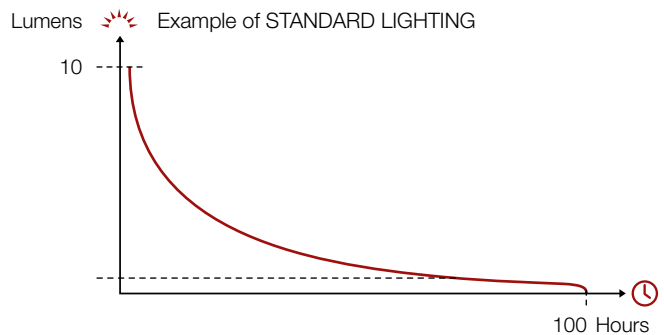

Prioritizing guaranteed brightness over time: CONSTANT LIGHTING

Brightness stays constant as the batteries drain. When the batteries are almost drained, the headlamp switches automatically to reserve lighting, providing reduced brightness with longer burn time.

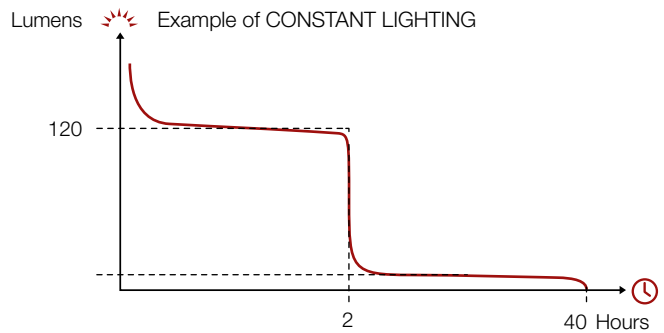

Optimized lighting performance: REACTIVE LIGHTING®

Brightness varies according to the user's need. Intelligent lighting optimizes battery life, offering longer burn time.

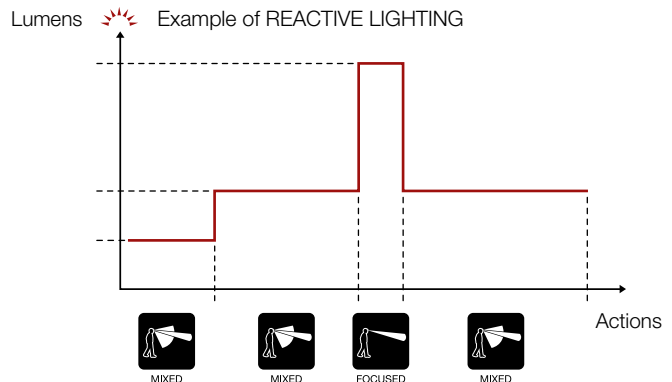

Different Beam Types



LARGE

Wide beam

Wide beam designed for proximity lighting, to see up close or around your feet. The wide angle provides a very large and comfortable field of view.



MIXED

Mixed beam

Mixed beam consists of a wide beam and a focused component, allowing both proximity lighting and longer-range vision for moving around.



FOCUSED

Focused beam

Focused beam allows focused lighting on a target in order to see objects or people at a distance.

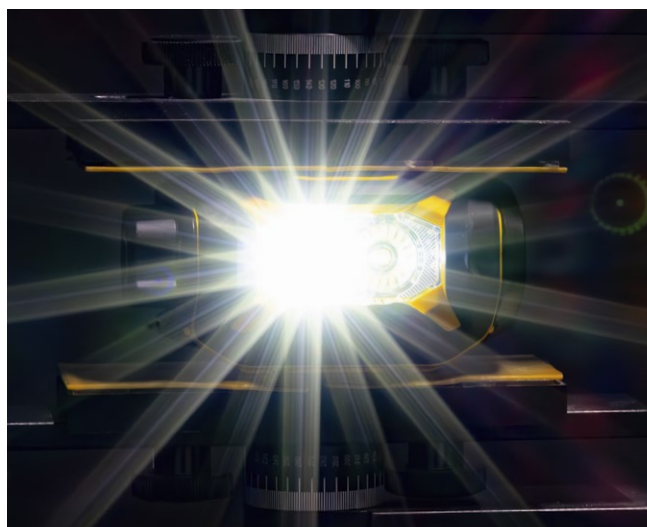

© 2024 Petzl Distribution - Lafouche

Brightness: the shape of the beam directly affects lighting distance

Lighting distance depends directly on brightness, but mainly on the shape of the beam. In fact, given the same brightness, lighting distance will vary depending on the shape of the beam.

Petzl indicates the different lighting modes available for each headlamp. These modes correspond to specific conditions of use: close-range work, moving around, seeing at a distance.

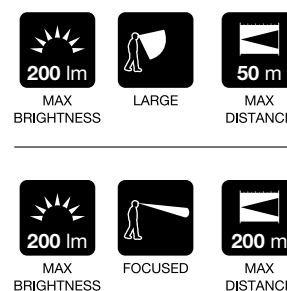

Lighting performance as defined by the ANSI/PLATO FL 1 protocol

Petzl has chosen to comply with the ANSI (American National Standards Institute) FL 1 protocol to measure and demonstrate the lighting performance of our headlamps. This voluntary move allows users to easily compare the lighting performance of different headlamp models using standardized criteria.

Lighting Performance: How Is It Measured?



MAX BRIGHTNESS

Brightness (lumens)

This measurement is taken between 30 and 120 seconds after the headlamp is turned on. It indicates the maximum light output when the lamp is first turned on using new batteries (included).



MAX BURN TIME

Burn time (hours)

This is the length of time for which lighting remains optimal, from the moment the lamp is turned on until it drops to 10% of maximum light output. It then switches to reserve lighting.



MAX DISTANCE

Lighting distance (meters)

This is the maximum distance between the lamp and the location where only 0.25 lux of illumination remains. The measurement is taken when the lamp is turned on, using new batteries. Lighting distance depends directly on brightness, but mainly on the shape of the beam.



RESERVE LIGHTING

Reserve lighting (outside of the ANSI/PLATO FL 1 protocol)

In addition to these measures, Petzl offers reserve lighting. Reserve lighting provides a minimum light level to be able to move around. However, the lighting may be insufficient for certain activities (such as precision work or inspection).

Potentially Explosive Atmospheres

If an explosion hazard is identified in an environment, the hazardous areas are classified as areas at risk, depending on the prevalence and type of combustible, gas or dust. All of the materials used in these zones must conform with current regulations for this type of zone (ATEX and/or HAZLOC).

The PIXA Z0 was designed to meet the needs of maintenance and industrial professionals working in potentially explosive environments. It has the following certifications: ATEX area 0 (II 1 G Ex ia IIC T4), HAZLOC (Class I Div 1 A, B, C, D T4), and IECEx (Gas: Ex ia IIC T4 Ga). Durable, waterproof, and resistant to certain chemicals, it is ideal for intensive and demanding professional use.



PIXA® Z0

Classification of ATEX / HAZLOC zones

Potentially Explosive Atmosphere	Gas Type Combustible	
	ATEX	HAZLOC
Permanent or Long-Term	ZONE 0	Class I Div 1
Occasional	ZONE 1	Class I Div 1
Accidental	ZONE 2	Class I Div 2

Example of ATEX area (gas type combustible)

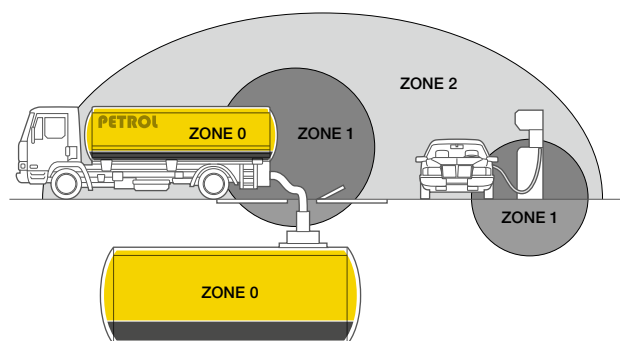

For more information on ATEX and HAZLOC regulations, see Petzl.com

How to read an ATEX or HAZLOC marking on the PIXA Z0 headlamp?

	II 1 G	Ex ia	IIC	T4	Ga
HAZLOC	Class I Div 1 A, B, C, D			T4	

ATEX CODING

	II Equipment group	1 Equipment category	G
EU Explosive atmosphere symbol	I: mining	M1: energised	
		M2: de-energised*	
	II: non-mining	1: zone 0	
		2: zone 1	
3: zone 2			
			Gas

* in presence of explosive atmosphere

ELECTRICAL PROTECTION CONCEPTS

Standard IEC/EN	Code	Intrinsic Safety	Zone
60079-11	Ex ia		
	Ex ib	1	
	Ex ic	2	

CSA C22.2 No. 60079-11, UL 60079-11 and UL 913

GAS GROUPS

Gas group	Representative test gas
I	Methane (mining only)
IIA	Propane
IIB	Ethylene
IIC	Hydrogen

Gases are classified according to the ignitability of gas-air mixture. Refer to IEC/EN 60079-20-1 for classification of common gases and vapors.

TEMPERATURE CLASS

T class	Maximum surface temperature
T1	450°C
T2	300°C
T3	200°C
T4	135°C
T5	100°C
T6	85°C

EQUIPMENT PROTECTION LEVEL

Equipment protection level	Zone
ia	0 (Ga)
ib	1 (Gb)
ic	2 (Gc)

HAZLOC CODING

Class	Group	Division	
		1	2
I Gases, vapors, liquids	A: Acetylene	Explosive and always dangerous	Where ignitable concentrations of flammable gases, vapors or liquids are not likely to exist under normal operating conditions.
	B: Hydrogen		
	C: Ether		
	D: Hydrocarbons, fuels, solvents		



IP and IK Protection Index

The IP Protection Index

A headlamp's resistance to solids and/or liquids is indicated by its IP rating. This index classifies the level of protection offered by equipment against intrusions by solids (e.g. dust) and liquids (e.g. water, oil) according to the IEC 60529 standard.

Understanding the protection index

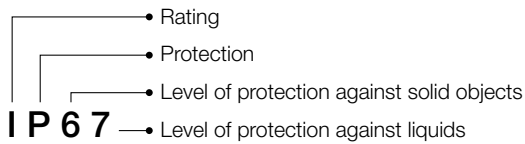

Protection against solid objects
X = Not measured
0 = Not protected
1 = Protected against projection of solid objects 50 mm or greater in diameter
2 = Protected against projection of solid objects 12.5 mm or greater in diameter
3 = Protected against projection of solid objects 2.5 mm or greater in diameter
4 = Protected against projection of solid objects 1 mm or greater in diameter
5 = Protected against dust (limited ingress, no harmful deposits)
6 = Completely protected against dust

Protection against liquids
X = Not measured
0 = Not protected
1 = Protected against vertically falling water drops
2 = Protected against water drops (15° from vertical)
3 = Protected against rain (60° from vertical)
4 = Protected against splashing water
5 = Protected against water jets
6 = Protected against powerful water jets
7 = Temporary immersion (-1 meter for 30 minutes)
8 = Prolonged immersion (deeper than 1 meter for period defined by manufacturer)
9 = Prolonged immersion (deeper than 1 meter) and protection against pressure-washing

Protection Against External Mechanical Impacts: IK Protection Index

The IK rating, as defined by the IEC 62262 standard, indicates the degree of protection against external mechanical impacts. In other words, the impact resistance of a product. The rating is composed of two numbers, each corresponding to a level of protection.

IK Rating	Impact Energy	Impact Equivalent
	In joules	Equivalent to impact of XX g dropped from XX cm
00	No protection	-
01	0.14 J	140 g - 10 cm
02	0.20 J	200 g - 10 cm
03	0.35 J	200 g - 17.5 cm
04	0.50 J	200 g - 25 cm
05	0.70 J	200 g - 35 cm
06	1 J	200 g - 10 cm
07	2 J	500 g - 20 cm
08	5 J	1700 g - 27.5 cm
09	10 J	5 kg - 20 cm
10	20 J	5 kg - 40 cm



Choosing a Petzl headlamp means selecting a work tool designed to withstand the most severe conditions of use while providing maximum reliability:











Testing from design to manufacturing

Each model must pass particularly stringent tests:

- For shock resistance, fall resistance, and crushing (including at low temperatures)
- For functional reliability (mechanical endurance)
- Individual inspection and test at the end of the assembly line (final quality check)
- For water resistance



Headlamp Specifications

									
STANDARD LIGHTING	CONSTANT LIGHTING	REACTIVE LIGHTING®	MAX BRIGHTNESS	MAX DISTANCE	MAX BURN TIME	RESERVE LIGHTING	LARGE	MIXED	FOCUSED
ANSI/PLATO FL 1									







Powerful and Intelligent Headlamps

DUO RL		•	-	•	2800 lm	255 m	72 h	•	•	•	•
XENA		-	•	-	1400 lm	170 m	32 h	•	•	•	•
SWIFT RL		•	-	•	1100 lm	155 m	100 h	•	-	•	•

Compact and Durable Headlamps

NEW2025 PIXA R		-	•	-	600 lm	90 m	12 h	•	•	•	•
NEW2025 PIXA		-	•	-	450 lm	80 m	12 h	•	•	•	•
NEW2025 PIXA Z0		-	•	-	350 lm	65 m	12 h	•	•	•	-

Ultra-Compact and Versatile Headlamps

ARIA 2R		•	-	-	600 lm	115 m	100 h	•	•	•	-
ARIA 1R		•	-	-	450 lm	75 m	110 h	•	•	-	-
ARIA 2		•	-	-	450 lm	100 m	100 h	•	•	•	-
ARIA 2 RGB											
ARIA 1		•	-	-	350 lm	70 m	110 h	•	•	-	-
ARIA 1 RGB											

Emergency Headlamp

e+LITE		•	-	-	40 lm	15 m	9 h 30	-	•	-	-
--------	---	---	---	---	-------	------	--------	---	---	---	---

RED LIGHTING	RGB LIGHTING	WHITE / RED STROBE	HYBRID CONCEPT	RECHARGEABLE	STANDARD BATTERIES	Certifications	IP INGRESS PROTECTION	IK IMPACT PROTECTION	WEIGHT	
-	-	-	-	●	3200 mAh	-	CE	IP67	-	390 g
-	-	● red	-	●	3200 mAh	-	CE	IP67	IK07	185 g
●	-	● red	-	●	2350 mAh	-	CE	IP54	IK05	110 g
-	-	-	-	●	1250 mAh	-	CE	IP68	IK08	130 g
-	-	-	●	-	3 x AAA LR03	-	CE	IP68	IK08	130 g
-	-	-	-	-	3 x AAA LR03 (1)	CE ATEX zone 0 (II 1 G Ex ia IIC T4) HAZLOC (Class I Div 1 A, B, C, D T4) IECEX (Gas : Ex ia IIC T4 Ga)	IP68	IK08	138 g	
-	-	-	●	●	1250 mAh	-	CE	IP67	IK07	95 g
-	-	-	●	●	1250 mAh	-	CE	IP67	IK07	94 g
-	-	-	●	-	3 x AAA LR03	-	CE	IP67	IK07	106 g
-	-	-	●	-	3 x AAA LR03	-	CE	IP67	IK07	105 g
●	-	●	-	-	2 x lithium CR2032	-	CE	IPX7	-	26 g

POWERFUL AND INTELLIGENT HEADLAMPS

Powerful and intelligent headlamps designed for intensive use by maintenance, industrial, or rescue professionals.



Night via ferrata rescue exercise, Vadiello, Huesca, Spain © 2023 Petzl Distribution - Vuedici.org - GREIM - Guardia Civil

DUO RL

Ultra-powerful and rechargeable multi-beam headlamp featuring REACTIVE LIGHTING technology. 2800 lumens



R2



Quick Charger



Extension Cord for Headlamp



PRO ADAPT

XENA

Powerful, rechargeable, lightweight, and balanced headlamp featuring CONSTANT LIGHTING technology. 1400 lumens



R1



R1 Extension Cord



SLOT ADAPT



NEW 2025

HELMET ADAPT



UNIADAPT



Spare XENA Headband

SWIFT RL

Compact, powerful, lightweight, and rechargeable headlamp featuring REACTIVE LIGHTING technology. 1100 lumens



SWIFT RL Rechargeable Battery



SLOT ADAPT



NEW 2025

HELMET ADAPT



UNIADAPT



POCHE PIXA & SWIFT RL



PRO 28MM Headband



Powerful and Intelligent Headlamps



DUO RL

Ultra-powerful and rechargeable multi-beam headlamp featuring REACTIVE LIGHTING® technology. 2800 lumens

Designed for technical rescue and worksites, the DUO RL rechargeable headlamp provides 2800-lumen brightness. Using REACTIVE LIGHTING technology, a sensor analyzes the ambient light and automatically adjusts brightness to user needs. Manual operation is minimized and burn time is optimized, so the user can remain focused on the activity. The aluminum lamp body provides excellent impact resistance. The DUO RL is waterproof and ideal for use in wet environments. 3200 mAh rechargeable battery.



REACTIVE LIGHTING®

Longer burn time, greater visual comfort, and less manual operation with REACTIVE LIGHTING mode, which allows the light sensor to automatically adjust brightness and beam pattern, optimizing battery life.



IP 67
INGRESS PROTECTION

Dustproof and waterproof in up to 3 meters of fresh water for 30 minutes.



DUO RL headlamp



2800 lm
MAX BRIGHTNESS



255 m
MAX DISTANCE



72h
MAX BURN TIME



Ultra-bright with 2800 lumens and multi-beam lighting to suit a wide variety of situations.



Aluminum lamp body provides excellent fall, crush, and impact resistance.

Accessories



R2

Rechargeable battery for DUO RL headlamps. 3200 mAh



Quick Charger

EUR/US-compatible quick wall charger for R2 rechargeable battery



Extension Cord for Headlamp

Extension power cable for DUO RL headlamps



PRO ADAPT

Adhesive accessory for mounting a DUO headlamp on a variety of different helmet types



XENA headlamp



1400lm
MAX BRIGHTNESS



170 m
MAX DISTANCE



32h
MAX BURN TIME



Powerful and lightweight, XENA casts 1400 lumens at 185 grams. The battery is worn in the rear for a more balanced and comfortable fit.

XENA®

Powerful, rechargeable, lightweight, and balanced headlamp featuring CONSTANT LIGHTING technology. 1400 lumens (BOOST mode)

Designed for maintenance, industrial, inspection, and technical rescue professionals, the XENA headlamp offers an excellent weight-to-power ratio (185 grams / 1400 lumens). The battery pack is in the rear, making it balanced and comfortable to wear. Durable, it is fall and impact resistant. It is also waterproof and dustproof, making it suitable for various work conditions. Three beam types and five lighting levels provide optimal visual comfort in a variety of situations. CONSTANT LIGHTING technology provides stable lighting intensity over time. It features a rotating knob that is easy to use, even when wearing gloves. Wear the lamp on your head or mounted on a variety of helmet types using compatible accessories for a convenient solution. Rechargeable via USB-C, the 3200 mAh battery is removable and replaceable.



CONSTANT LIGHTING

CONSTANT LIGHTING technology provides stable brightness over a given amount of time.

Accessories



R1

Rechargeable battery for the XENA headlamp. 3200 mAh

The R1 rechargeable battery, 3200 mAh (3,7 V / 11,84 Wh), provides excellent lighting performance for the XENA headlamp, even at low temperatures. It recharges with a USB-C port and has a five-level gauge for precise monitoring of the battery charge level. It is equipped with red lighting for visibility from behind and can be used as a spare battery to charge other electronic devices.



R1 Extension Cord

Extension cord for the XENA headlamp

Extension cord for the XENA headlamp R1 battery, allowing it to be carried separately to reduce weight on the head, as well as preserve battery and headlamp performance when temperatures are low.



SLOT ADAPT

Plate for mounting a XENA headlamp on a Petzl helmet

Plate for mounting a XENA headlamp on a Petzl VERTEX or STRATO helmet, maintaining the ability to tilt the headlamp.



HELMET ADAPT

Adhesive plate for mounting a XENA headlamp on a helmet

Adhesive plate for mounting a headlamp on a helmet, maintaining the ability to tilt the headlamp.



UNI ADAPT

Adhesive clip for mounting a Petzl headlamp on a variety of helmet types (pack of 4)



Spare XENA® Headband

Spare headband for the XENA headlamp



Powerful and Intelligent Headlamps



SWIFT® RL

Compact, powerful, lightweight, and rechargeable headlamp featuring REACTIVE LIGHTING® technology. 1100 lumens

Designed for maintenance, inspection, and rescue professionals, the rechargeable SWIFT RL headlamp offers 1100 lumens of brightness at only 110 grams. Using REACTIVE LIGHTING technology, a sensor analyzes the ambient light and automatically adjusts brightness to user needs. Manual operation is minimized and burn time is optimized, so the user can remain focused on the task. The mixed beam provides visual comfort for a variety of work situations. Easy to use, with a single button for controlling all lamp functions. Wear the lamp on your head or mounted on a helmet using compatible accessories for a convenient solution. Rechargeable via USB-C, the 2350 mAh battery is removable and replaceable.



Longer burn time, visual comfort, and minimal manual operation with REACTIVE LIGHTING mode.



Removable and replaceable 2350 mAh battery, rechargeable via USB-C port.



Powerful and lightweight:
1100 lumens at only 110 g.



The five-level gauge allows precise
monitoring of the battery charge level.

Accessories



SWIFT® RL rechargeable battery

Rechargeable battery for the SWIFT RL headlamp. 2350 mAh

The 2350 mAh (3.7 V / 8.69 Wh) rechargeable battery for the SWIFT RL headlamp can be recharged via USB-C port and has a battery charge indicator.



SLOT ADAPT

Plate for mounting a SWIFT RL headlamp on a Petzl helmet

Plate for mounting a SWIFT RL headlamp on a Petzl VERTEX or STRATO helmet, maintaining the ability to tilt the headlamp.



HELMET ADAPT

Adhesive plate for mounting a SWIFT RL headlamp on a helmet

Adhesive plate for mounting a headlamp on a helmet, maintaining the ability to tilt the headlamp.



UNI ADAPT

Adhesive clip for mounting a Petzl headlamp on a variety of helmet types (pack of 4)



POCHE PIXA® & SWIFT® RL

Carry pouch for PIXA and SWIFT RL headlamps



**PRO 28MM Headband
Spare Headband for SWIFT RL**

	Certifications	 CONSTANT LIGHTING	 REACTIVE LIGHTING®	Lighting Colors	Lighting Modes	ANSI/PLATO FL 1			Weight
						 MAX BRIGHTNESS	 MAX DISTANCE	 MAX BURN TIME	
 DUO RL E103AA0	CE	-	●	White	Close-Range Work (1)	25 - 120 lm	18 m	24 - 72 h	390 g
					Movement (1)	50 - 250 lm	32 m	12 - 38 h	
					Rapid Movement (1)	100 - 550 lm	75 m	6 - 24 h	
					Maximum Power (1)	150 - 2800 lm	255 m	1 h 30 - 18 h	
					Focused (1)	100 - 900 lm	235 m	3 - 24 h	
					Close-Range Work (1)	80 lm	16 m	24 h	
					Movement (1)	200 lm	32 m	12 h	
					Rapid Movement (1)	450 lm	70 m	6 h	
					Maximum Power (1)	1800 lm	200 m	1 h 30	
					Focused (1)	700 lm	230 m	3 h	
					Survival Mode: Low	20 lm	8 m	72 h	
					Survival Mode: High	100 lm	26 m	24 h	
 XENA E004BA00	CE	●	-	White	Close-Range Work	45 lm	20 m	32 h	185 g
					Proximity	150 lm	40 m	10 h	
					Movement	225 lm	65 m	6 h 30	
					Rapid Movement	420 lm	100 m	3 h 20	
					Distance Vision	450 lm	125 m	3 h	
					BOOST	1400 lm	170 m	10 s	
				Reserve Lighting	15 lm for 2 h				
				Red (Rear)	Continuous	1 lm	1 m	75 h	
Strobe	Visible at 200 m for 250 h								
 SWIFT RL E810AB00	CE	-	●	White	Close-Range Work	18 - 100 lm	35 m	10 - 70 h	110 g
					Proximity	25 - 275 lm	75 m	7 - 45 h	
					Movement	30 - 1100 lm	155 m	2 - 35 h	
					Distance Vision	25 - 600 lm	150 m	4 - 50 h	
				White	Close-Range Work	10 lm	12 m	100 h	
					Proximity	160 lm	50 m	7 h	
					Movement	700 lm	115 m	2 h	
					Distance Vision	280 lm	95 m	4 h	
				Reserve Lighting	10 lm for 2 h				
				Red	Continuous	4 lm	6 m	50 h	
Strobe	Visible at 150 m for 300 h								

(1) Factory setting, programmable by user.

Accessories		Weight
R2	E103CA00	168 g
Quick Charger	E55800 E55800 UK	145 g
Extension Cord for Headlamp	E55950	75 g
PRO ADAPT	E80004	48 g
SLOT ADAPT	E073BA00	11 g
Spare DUO headband	E51999	-

		Weight
R1	E037AA00	80 g
R1 Extension Cord	E105BA00	45 g
Spare XENA Headband	E007CA00	185 g
HELMET ADAPT	E073AA00	22 g
UNI ADAPT	E000BA00	10 g
SWIFT RL Rechargeable Battery	E092DB00	50 g
POCHE PIXA & SWIFT RL	E78001	44 g
PRO 28MM Headband	E092FB00	26 g



COMPACT AND DURABLE HEADLAMPS

Headlamps designed for frequent use, for the energy and networks, and building and maintenance markets.



PIXA R

Compact, durable, waterproof, and rechargeable headlamp designed for demanding environments. 600 lumens (BOOST mode)

NEW 2025



PIXA

Compact, durable, and waterproof headlamp designed for demanding environments. 450 lumens (BOOST mode)

NEW 2025



PIXA Z0

Compact, durable, and waterproof headlamp designed for potentially explosive environments. 350 lumens (BOOST mode)

NEW 2025



Accessories

NEW 2025



CORE PRO

NEW 2025



Charging Cable for CORE PRO



SLOT ADAPT

NEW 2025



HELMET ADAPT

NEW 2025



RUBBER EX

NEW 2025



Headband for PIXA Z0 EX



PRO 28MM Headband



Compact and Durable Headlamps

Headlamps designed for frequent to intensive use by professionals working in demanding environments in the maintenance industry.

• Versatile lighting

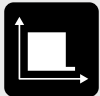

CONSTANT LIGHTING

CONSTANT LIGHTING technology offers a constant level of brightness throughout the duration of use, helping to reduce visual fatigue for the user. When the batteries are almost drained, the headlamp switches automatically to reserve lighting, providing reduced brightness with longer burn time.



BOOST MODE

PIXA headlamps have a BOOST mode that can be used at any time for the occasional need for maximum brightness.

• Waterproof, robust and durable



The PIXA headlamps are waterproof (IP68), durable (IK08), crush resistant (80 kg), fall resistant, and impact resistant, as well as resistant to certain chemicals to adapt to demanding work conditions for industrial and maintenance professionals.

• Convenient



All lamp functions are accessible with the rotating selector knob. Convenient, it can be operated while wearing gloves. The selector knob is on the side of the headlamp, so it can be used without dirtying the optical lens.



When not in use and for safe storage, the headlamp features a 180° rotation system that can be locked in place to protect the lens.



Adaptable for helmets, PIXA headlamps come with a SLOT ADAPT plate, which allows them to be mounted on a professional Petzl helmet. They are also compatible with the HELMET ADAPT adhesive plate (available as an accessory) for installing it on a variety of helmet types.

• For demanding environments



Rechargeable, the PIXA R comes with the CORE PRO battery and a charging cable.



LARGE



MIXED



FOCUSED



The PIXA features the HYBRID CONCEPT design and comes with 3 standard batteries.



LARGE



MIXED



FOCUSED

• For potentially explosive and demanding environments



PIXA Z0 has the following certifications: ATEX zone 0 (II 1 G Ex ia IIC T4), HAZLOC (Class I Div 1 A, B, C, D T4), and IECEx (Gas: Ex ia IIC T4 Ga).



LARGE



MIXED

PIXA headlamps



NEW
2025

600 lm
MAX BRIGHTNESS

90 m
MAX DISTANCE

12h
MAX BURN TIME

PIXA® R

Compact, durable, waterproof, and rechargeable headlamp designed for demanding environments. 600 lumens (BOOST mode)

The PIXA R was designed to meet the needs of maintenance and industrial professionals. Durable, waterproof, and resistant to certain chemicals, it is ideal for intensive and demanding professional use. The PIXA R is convenient and can easily be installed on a helmet with the included SLOT ADAPT plate. It's easy to use, with a single selector knob that controls all functions. The rotating selector knob can be used while wearing gloves. Rechargeable, the PIXA R comes with the CORE PRO rechargeable battery (1250 mAh). It's removable and can be switched out in order to continue working. Featuring CONSTANT LIGHTING technology, it provides a constant level of brightness. Casting 600 lumens in BOOST mode and three beam types (wide, mixed, and focused), the PIXA R adapts to a variety of work situations. The PIXA R should not be used in a potentially explosive atmosphere.



NEW
2025

450 lm
MAX BRIGHTNESS

80 m
MAX DISTANCE

12h
MAX BURN TIME

PIXA®

Compact, durable, and waterproof headlamp designed for demanding environments. 450 lumens (BOOST mode)

The PIXA was designed to meet the needs of maintenance and industrial professionals. Durable, waterproof, and resistant to certain chemicals, it is ideal for intensive and demanding professional use. Convenient, the PIXA can easily be installed on a helmet with the included SLOT ADAPT plate. It's easy to use, with a single selector knob that controls all functions. The rotating selector knob can be used while wearing gloves. Featuring CONSTANT LIGHTING technology, it provides a constant level of brightness. Casting 450 lumens in BOOST mode and three beam types (wide, mixed, and focused), PIXA adapts to a variety of work situations. The PIXA should not be used in a potentially explosive atmosphere.



NEW
2025

350 lm
MAX BRIGHTNESS

65 m
MAX DISTANCE

12h
MAX BURN TIME

PIXA® Z0

Compact, durable, and waterproof headlamp designed for potentially explosive environments. 350 lumens (BOOST mode)

The PIXA Z0 was designed to meet the needs of maintenance and industrial professionals working in potentially explosive environments. It has the following certifications: ATEX area 0 (II 1 G Ex ia IIC T4), HAZLOC (Class I Div 1 A, B, C, D T4), and IECEx (Gas: Ex ia IIC T4 Ga). Durable, waterproof, and resistant to certain chemicals, it is ideal for intensive and demanding professional use. The PIXA Z0 is convenient and can easily be installed on a helmet with the included SLOT ADAPT plate. It's easy to use, with a single selector knob that controls all functions. The rotating selector knob can be used while wearing gloves. Featuring CONSTANT LIGHTING technology, it provides a constant level of brightness. Casting 350 lumens in BOOST mode and two beam types (wide, mixed), the PIXA Z0 adapts to a variety of work situations.



Compact and Durable Headlamps

Accessories

NEW
2025



CORE PRO

Rechargeable battery compatible with the PIXA R headlamp. 1250 mAh

High-capacity 1250 mAh (3.6 V / 4.5 Wh) lithium-ion rechargeable battery for the PIXA R headlamp. It provides excellent lighting performance, even at low temperatures. It can be recharged without being removed from the headlamp, or externally, via external charging contact points and its charging cable. The CORE PRO rechargeable battery offers an economical solution as the main power supply or as a backup battery.

NEW
2025



Charging Cable for CORE PRO

CORE PRO Charging Cable

▶



SLOT ADAPT

Plate for mounting a PIXA headlamp on a Petzl helmet

Plate for mounting a headlamp from the PIXA range on a Petzl VERTEX or STRATO helmet, maintaining the ability to tilt the headlamp.

NEW
2025



HELMET ADAPT

Adhesive plate for mounting a PIXA headlamp on a helmet

Adhesive plate for mounting a headlamp on a helmet, maintaining the ability to tilt the headlamp.

NEW
2025



RUBBER EX

Rubber headband for the PIXA headlamp, compatible with a variety of helmet types

The RUBBER EX headband adapts to a variety of helmets on the market and holds a PIXA headlamp securely in place.

NEW
2025



Headband for PIXA® Z0 EX

Spare headband for the PIXA Z0 headlamp

Spare headband for the PIXA Z0 headlamp, designed for use in potentially explosive environments.



PRO 28MM Headband

Spare headband for PIXA R and PIXA headlamps



	Certifications	 CONSTANT LIGHTING	Lighting Modes	ANSI/PLATO FL 1			Weight
				 MAX BRIGHTNESS	 MAX DISTANCE	 MAX BURN TIME	
 PIXAR E120CA00 NEW2025	CE	●	Close-Range Work	45 lm	15 m	12 h	130 g
			Movement	90 lm	30 m	6 h	
			Rapid Movement	250 lm	50 m	2 h	
			Distance Vision	250 lm	65 m	2 h	
			BOOST	600 lm	90 m	10 s	
			Reserve Lighting	15 lm for 2 h			
 PIXA E120AA00 NEW2025	CE	●	Close-Range Work	35 lm	10 m	12 h	138 g
			Movement	60 lm	25 m	6 h	
			Rapid Movement	145 lm	40 m	2 h	
			Distance Vision	140 lm	50 m	2 h	
			BOOST	450 lm	80 m	10 s	
			Reserve Lighting	15 lm for 2 h			
 PIXAZO E120BA00 NEW2025	CE ATEX zone 0 (II 1 G Ex ia IIC T4) HAZLOC (Class I Div 1 A, B, C, D T4) IECEX (Gas : Ex ia IIC T4 Ga)	●	Close-Range Work	30 lm	10 m	12 h	138 g
			Movement	50 lm	25 m	6 h	
			Rapid Movement	130 lm	40 m	2 h	
			BOOST	350 lm	65 m	8 s	
			Reserve Lighting	15 lm for 2 h			

Accessories		Certifications	Weight
NEW2025 CORE PRO	E132AA00	CE	25 g
NEW2025 Charging Cable for CORE PRO	E131AA00	CE	30 g
SLOT ADAPT	E073BA00	-	11 g
NEW2025 HELMET ADAPT	E073AA00	-	22 g
NEW2025 RUBBER EX	E130BA00	IEC 60079-0	35 g
NEW2025 Headband for PIXAZO EX	E130AA00	IEC 60079-0	20 g
PRO 28MM Headband	E092FB00	-	26 g



ULTRA-COMPACT AND VERSATILE HEADLAMPS

Ultra-compact and versatile headlamps designed for occasional or frequent use by tradespeople, maintenance professionals, or stage workers.



Stainless steel plumbing, France © 2023 Petzl Distribution - Rémi Flament - Croze

ARIA 2R

Compact, rechargeable, durable, and waterproof headlamp, with lighting designed for proximity vision and movement. 600 lumens



ARIA 1R

Compact, rechargeable, durable, and waterproof headlamp, designed for proximity lighting. 450 lumens



ARIA 2 / ARIA 2 RGB

Compact, durable, and waterproof headlamp, designed for proximity lighting and movement. 450 lumens



ARIA 1 / ARIA 1 RGB

Compact, durable, and waterproof headlamp designed for proximity lighting. 350 lumens



Accessories



CORE



SLOT ADAPT

NEW 2025



HELMET ADAPT



UNIADAPT

NEW 2025



RUBBER EX



SHELL L



Spare Headband for ARIA

Emergency Headlamp

e+LITE

Ultra-compact emergency headlamp. 40 lumens



Ultra-Compact and Versatile Headlamps

• Ultra-compact

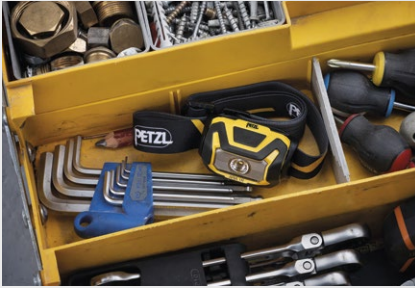

Ultra-compact, ARIA headlamps can be easily stored in a toolbox.

• Waterproof and durable



ARIA headlamps are designed to meet the needs of professionals: waterproof (IP67), impact resistant (IK07), and fall resistant up to 2 meters.

• Easy to use



The single button on ARIA headlamp allows you to access every lamp function: on/off, lighting levels, lighting colors (black version only), lock, and battery level.

• Convenient

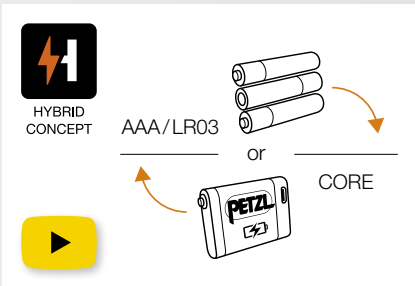

The HYBRID CONCEPT design allows the headlamps to function with standard AAA/LR03 batteries or with a CORE rechargeable battery. The headlamp automatically detects the energy source and optimizes lighting performance. With a rechargeable CORE battery, the lamp provides more brightness when it is turned on and throughout the duration of use.

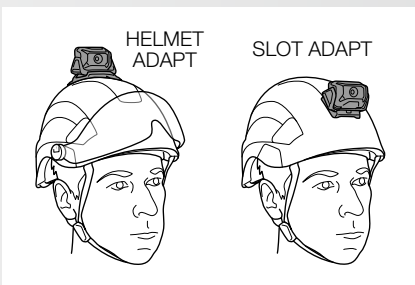

The headband allows ARIA headlamps to be worn on the head or around the neck. They can also be mounted on a helmet, with mounts available as accessories: HELMET ADAPT (compatible with a variety of helmet types) and SLOT ADAPT (for helmets with compatible slots).

• For frequent use, lamps with rechargeable battery

Wide and mixed beam



Wide beam



• For occasional use, lamps with standard batteries

Wide and mixed beam



Wide beam



Ultra-Compact and Versatile Headlamps

Accessories



CORE

Rechargeable battery compatible with Petzl headlamps featuring the HYBRID CONCEPT design. 1250 mAh

High-capacity 1250 mAh (3.6 V / 4.5 Wh) lithium-ion rechargeable battery for Petzl headlamps featuring the HYBRID CONCEPT design: ARIA 1, ARIA 1R, ARIA 2, and ARIA 2R. It provides excellent lighting performance, even at low temperatures. It recharges directly with the integrated USB port. The CORE rechargeable battery offers an economical solution as the main power supply or as a backup battery.



SLOT ADAPT

Plate for mounting an ARIA headlamp on a Petzl helmet

Plate for mounting a headlamp from the ARIA range on a Petzl VERTEX or STRATO helmet, maintaining the ability to tilt the headlamp.



HELMET ADAPT

Adhesive plate for mounting an ARIA headlamp on a helmet

Adhesive plate for mounting a headlamp on a helmet, maintaining the ability to tilt the headlamp.



UNI ADAPT

Adhesive clip for mounting a Petzl headlamp on a variety of helmet types (pack of 4)



Spare Headband for ARIA®

Spare headband for headlamps from the ARIA range.



RUBBER EX

Rubber headband for the ARIA headlamp, compatible with a variety of helmet types

The RUBBER EX headband adapts to a variety of helmets on the market and holds a ARIA headlamp securely in place.



SHELL L

Pouch for storing ultra-compact headlamps from the ARIA range.

Emergency Headlamp



e+LITE®

Ultra-compact emergency headlamp. 40 lumens

Ultra-lightweight and highly compact, the e+LITE emergency headlamp is the one to always have with you. With a carrying case, it's always ready to use and can be stored with its batteries for ten years in a backpack, vest, or emergency kit, or used as a backup headlamp. It casts 40 lumens of continuous or strobe, white or red lighting, so you can be seen. The whistle integrated in the elastic headband allows the user to signal an emergency. Weighing only 26 grams, e+LITE is an ideal emergency headlamp.

Continuous or strobe lighting (white or red) allows you to be seen and to signal an emergency.



© Sam Bié

Climbing

Whether climbing at a crag or on an indoor wall, Petzl is constantly imagining new solutions for dedicated climbers, or for those simply seeking a moment to recreate and be social.

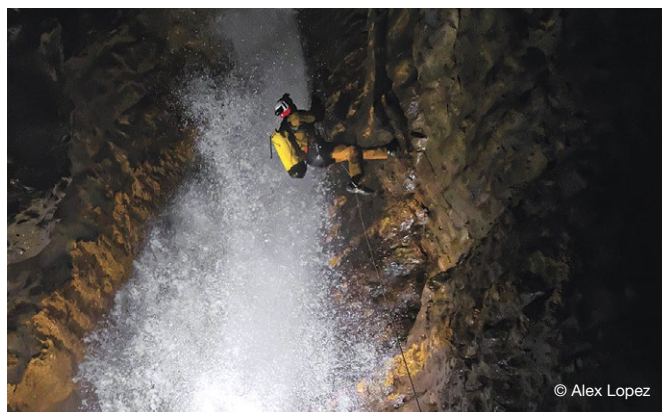

© Alex Lopez

Caving

Petzl's roots are in subterranean exploration! For over 50 years, since the development of our very first headlamps, rope clamps and descenders, we have shared a profound connection with explorers of the deep.



© Mathis Dumas

Ice Climbing

Ice climbing is very technical and requires highly specialized equipment. Gullies, couloirs, icefalls: climbing these ephemeral formations always brings an extra bit of adventure.



© Peignée Verticale

Mountaineering

Deploy every technique for progression on snow, ice, or rock. Put your skills to the test and choose the right gear. Do whatever it takes to reach the summit and find your limit.



© Sam Bié

Canyoning

A combination of hiking, climbing, and swimming in whitewater, canyoning has become a major outdoor activity in recent years, even outside the summer season.



© Sam Bié

Via Ferrata

Via ferrata is the most approachable way to discover the vertical environment, via a route made of cables, ladders, and steps on a rock wall. It's a wonderful introduction to more technical pursuits.



© Arnaud Childéric

After Dark Outdoor Activities

Disconnect from everyday life and get back to nature for an evening or a weekend. Make your days longer; stargaze, observe the wildlife, or simply share a moment around a campfire with family or friends.



© Anthony Deroeux

Night Running

Get out of the house, hit the trails or run the city streets. Running gives you a fresh perspective on your daily life, whether your goal is to spend time in nature or push your limits in training.



© James Roh

Tactical, Special Forces

Tactical operations in a hostile environment require maximum safety in every situation, so being able to count on the quality and performance of the equipment is essential.



Exploring New Horizons

The Petzl Foundation's mission is to support and initiate public interest projects through its activities in mountainous and vertical domains; projects that help bring balance to humankind's place in its natural, cultural, and economic environments. The foundation supports non-profit organizations through financial and equipment grants, as well as consultation and training.

Our courses of action:



Prevent accidents in vertical environments



Encourage mountain exploration



Support ecological transition in mountainous areas

New Knowledge About the Work Conditions of Rope Access Technicians

The Laboratory of Vulnerabilities and Innovation in Sport (University of Lyon 1) and the Petzl Foundation are publishing their first round of results from an ongoing study on the working conditions of rope access technicians in France.

This research focuses on the organization of work, career paths of rope access technicians, and mental, physiological and mechanical demands placed on these professionals in the course of their work. It is a continuation of a 2017 epidemiological study on injuries suffered by French rope access technicians that was also supported by the Petzl Foundation⁽¹⁾.

Without diving into the details of the results published in the summary, "A Look at the Working Conditions of Rope Access Technicians"⁽²⁾, we can say that:

- The amount of time spent with arms raised at an angle that suggests high risk of injury (> 90°) is up to two times greater for those on rope than those on ground level.
- Every week, a rope access technician performs an average of close to 2500 arm lifts that suggest risk (>60°), for both right and left arms; a figure comparable to the average 2500 strokes per week that a tennis player hits in training (national and international level).
- On average, rope access technicians exert effort of moderate intensity throughout a workday (around 100 heartbeats per minute - bpm - equivalent to a rapid walk). We also observe several spikes of elevated intensity characterized by heart rates in excess of 140 bpm. The average heart rate of a person at rest is 70 bpm.
- Average levels and intensity spikes tend to be more elevated at the beginning of the week than at the end of the week. The proportion of high-intensity activity is higher at the beginning of the week and tends to decrease throughout the work week.
- A rope access technician's work week is characterized by a heavy mental workload (perceptions of pain and fatigue) that regularly increase throughout the week. However, the weeks are generally perceived to be pleasant, exciting, and stimulating (perceptions of challenge and reward, excitement).

1 - Vignal, Soulié, Rogowski, Epidemiological Study on French Rope Access Technicians, 2017. Find it online on www.fondation-petzl.org
 2 - Online at: https://www.petzl.com/fondation/s/mieux-connaître-blessures-cordiste?language=en_US

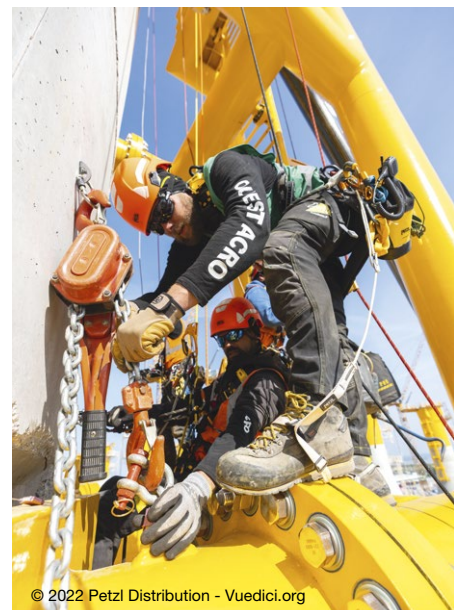

© 2022 Petzl Distribution - Vuedici.org

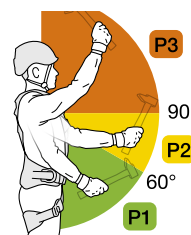

Elevating the arms less than 60° is considered to present a low risk of injury (P1), elevation between 60 and 90° is considered to present a risk of injury (P2), and elevation above 90° is considered to present a high risk of injury (P3).

See all Petzl Foundation projects

www.petzl.com

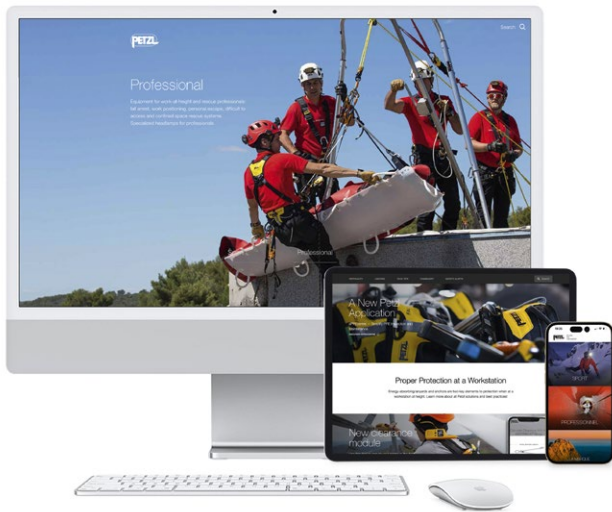

The site for professionals working at height and in dark environments.

- Discover Petzl solutions for verticality and lighting
- Check out tips and technical information on best practices for using Petzl products
- Find all the Petzl news and reports on various trades: videos, news, portraits, and events

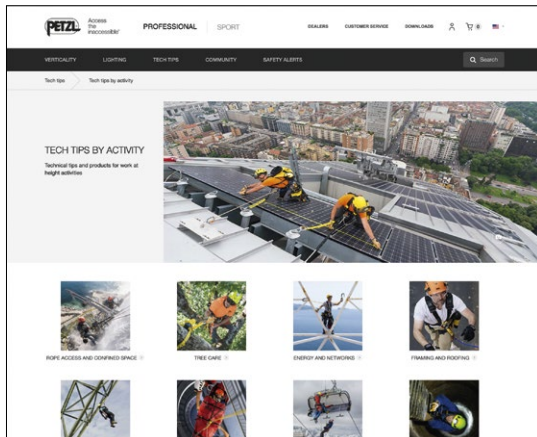

Pages to explore

Beyond our product offerings, Petzl offers a wide range of technical information: Instructions for Use, tech tips, PPE inspection records, and more.

Discover all the content pages on our website. Whether you are novice or expert in your field, Petzl shares its technical expertise to help you work more safely and efficiently.

On our product pages, you will find:

- Instructions for Use: they are the base of our technical information and provide the essentials for using your products. Remember to read them before using your products.
- Technical tips, "by Petzl". They contain information complementary to the Instructions for Use: test results, feedback, and technical videos. Documents with all you need to know about your products!
- Documents and procedures for PPE inspection: use them when you inspect your PPE

Find us on:



Subscribe to our newsletter and stay connected!

Find a Petzl dealer

© Petzl 2024



Petzl headquarters: PETZL INTERNATIONAL. Z.I. Crolles, 38920 CROLLES, FRANCE

Graphic design:
 Pierre Bena design - www.pierrebenadesign.com
 Product photos (non-contractual photos): © Petzl
 Kalice - www.kalice.fr
 Aurélie Jeannette, Photographer - www.aureliejeannette.com
 Yannick Siegel

Digital Publication: Fluidbook.com

Access the inaccessible[®]

