

MORSA+ MORSADUE +



BISAGRA DE ENGANCHE RÁPIDO Y CONTRAPLACAS PREMONTADAS

Sólidas
Montaje muy rápido
Robustas

 SAVIO

 pt 

MORSA+/MORSADUE+

Novedad en la nueva contraplaca con un exclusivo dentado de enganche (patentado).



¡ Para mantener a distancia las imitaciones...
MORSA+ HA SACADO LOS DIENTES !

¡ MORSA+, gracias a su exclusivo dentado de enganche, asegura una resistencia al deslizamiento que ninguna otra bisagra puede garantizar!

PRIMERO FUE LA MORSA...

Hace 12 años, SAVIO presentaba MORSA (patentada), revolucionando la forma y los contenidos de las bisagras para ventanas y creando un nuevo estándar para el mercado.

MORSA + y MORSADUE +, UNA NUEVA REVOLUCIÓN

La contra placa de MORSA + y de MORSADUE+ ha sido enriquecida con un dentado de enganche (patentado) que le permite garantizar una fijación sin precedentes.

MORSA+ y MORSADUE+: la innovación de SAVIO en las bisagras para ventanas

NUEVO SISTEMA DE FIJACIÓN

El exclusivo dentado de la contraplaca, en la parte que se introduce dentro del perfil, se clava en la superficie garantizando una resistencia al deslizamiento vertical sin igual.

GAMA COMPLETA

Las distintas versiones disponibles permiten la colocación de la bisagra sobre todos los principales perfiles y en todas las soluciones.

SOPORTE

La resistencia de la bisagra permite soportar pesos muy elevados, desde 80 Kg con 2 bisagras de 2 alas (MORSA+) hasta 100 Kg con 3 bisagras de 3 alas.

MATERIALES

Utilizando la contraplaca, los tornillos y el pernio en acero inox, tenemos la posibilidad de colocar la bisagra incluso en ambientes corrosivos como zonas marinas, industriales, etc.

El tapón al sulfuro de molibdeno reduce los roces entre los distintos elementos, evitando de esta manera posibles ruidos molestos.

Bisagras de enganche rápido para ventanas y puerta-ventanas MORSA+

La cabeza de los tornillos tiene endaduras más profundas que permiten la utilización de atornilladores automáticos o neumáticos y su forma cónica aumenta la superficie de contacto en la bisagra.

Los agujeros de fijación tienen una ranura que hace posible una auto-regulación de la contraplaca, lo que ayuda a evitar los problemas ocasionados por las tolerancias normales de los extruídos y maximiza el agarre al perfil.

El diámetro de la bisagra de 14 mm y el mayor espesor de otros componentes, permiten obtener el máximo soporte de toda la categoría.

Pernio en acero inox de 7 mm de diámetro, que al ser estriado, elimina todas las tolerancias de acoplamiento, haciendo más rígida la bisagra.

Tapón al sulfuro de molibdeno que garantiza una larga duración sin desgaste. También está provista de anillos de centrado que le permiten centrar perfectamente el ala de la bisagra, garantizando una fijación muy sólida.

La contraplaca en acero inox con un espesor de 2.3 mm, premontada, tiene un diseño que moldeado en su zona de anclaje, aumenta la superficie de enganche en un 30%, y, al ser dentada, garantiza la máxima fijación al perfil de aluminio. Esta forma especial de la contraplaca hace posible que la fijación de la bisagra sea duradera en el tiempo. Además, un tratamiento especial de la moldura aumenta la superficie roscante de la misma contraplaca, permitiendo atornillar con más facilidad.

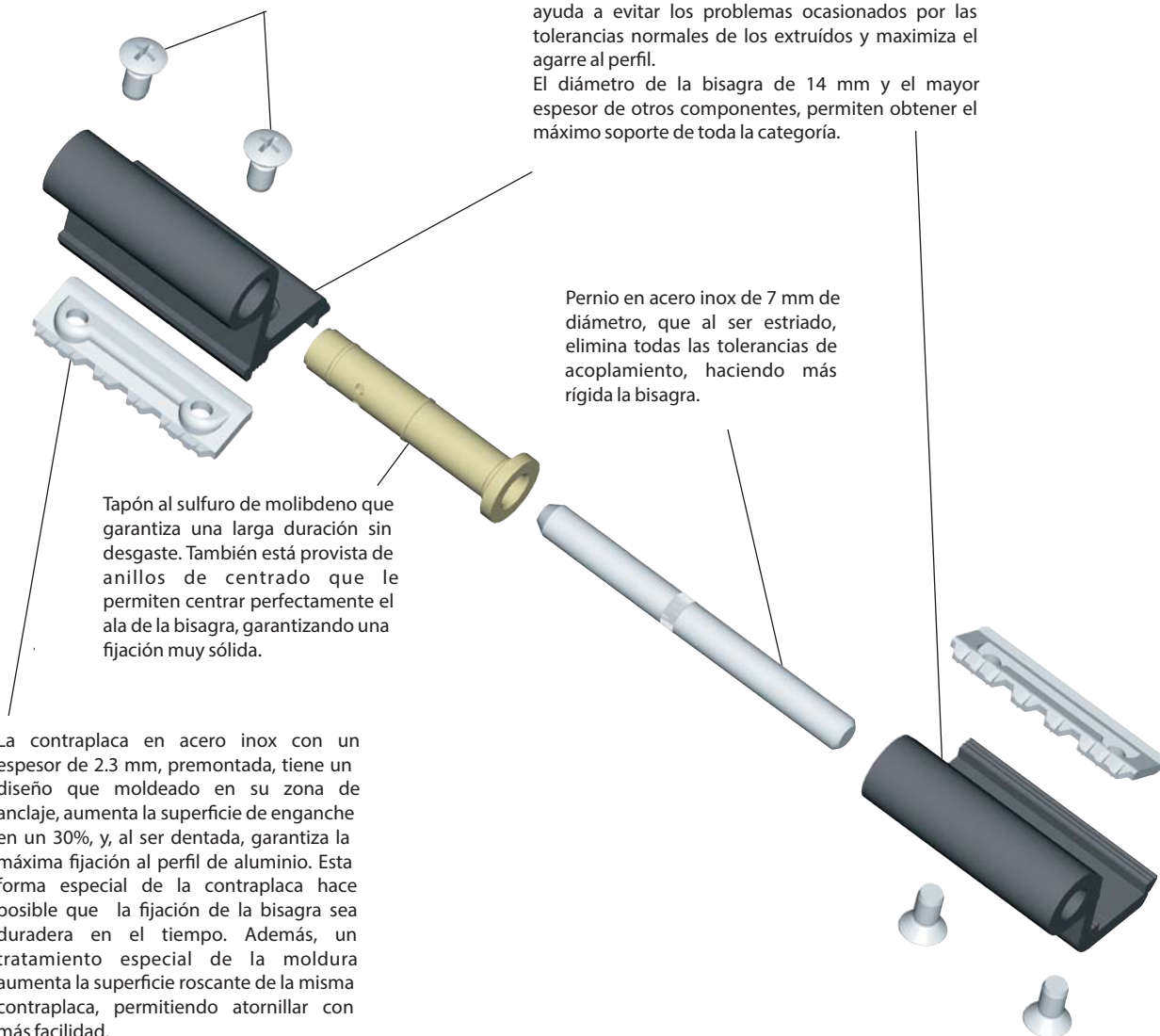

MORSA+

Bisagras para ventanas



Art.	Descripción	Unid.	Acabados
1121 1121.1	(patentado) Bisagra de 2 alas en aluminio, casquillo de nylon, pernio, pletinas y 4 tornillos TSC M5x10 pre-montados en acero inox 430.	50	C, F, U, NE, BL10, ZE, HL, 1013, 1015, 6002, 6005, 8017, 8019, 9001, 9005, 9010, B.SA, 9016, BR801, BW21, GR217, GR606, RD501, WT005
	Nueva versión con contraplaca dentada.	20	PVD H, PVD X, XSD
1121.2/.3/.4/.5/.7 1121.10/.13	Soporta: 2 bisagras 80 Kg, 3 bisagras 90 Kg.	50	C, F, U, NE, BL10, ZE, HL, 1013, 6005, 8017, 8019, 9001, 9005, 9010, BR801, GR217, GR606, RD501, WT005
1121.6/.9		50	C, F, U, NE, BL10, ZE, HL, 1013, 6005, 8017, 8019, 9001, 9005, 9010, BR801, BW21, GR217, GR606, RD501, WT005
1121.11		50	C, F, U, NE, BL10, ZE, HL, 1013, 6005, 8017, 8019, 9001, 9005, 9010, BR801, BW21, GR217, GR606, RD501, WT005
		20	PVD H, PVD X, XSD
1121.12		50	C, F, U, NE, BL10, ZE, HL, 1013, 6005, 8017, 8019, 9001, 9005, 9010, BR801, GR217, GR606, RD501, WT005
		20	XSD
1121.78		50	C, F, U, NE, BL10, ZE, HL, 1013, 6005, 8017, 9005, 9010
1121.79		50	C, F, U, NE, BL10, ZE, HL, 1013, 6005, 8017, 8019, 9001, 9005, 9010, BR801, GR217, GR606, RD501, WT005
1121/.1/.11 D	Como 1121/.1/.11 pero pre-montada a derechas.	50	F, NE, BL10, ZE, 1013, 9005, 9010
1121/.1/.11 S	Como 1121/.1/.11 pero pre-montada a izquierdas.	50	



Art.	Descripción	Unid.	Acabados
1121.951	Útil de montaje del pernio para art. 1121-1123, en acero zincado.	4	



Art.	Descripción	Unid.	Acabados
1121.952	Útil de montaje casquillos para art. 1115-1116-1121-1123, en acero zincado.	4	

Bisagras para ventanas



Art.	Descripción	Unid.	Acabados
1122/.1	(patentado) Bisagra de 3 alas en aluminio pre-montada, casquillos de nylon, pernios, pletinas y 6 tornillos TSC M5x10 pre-montados en acero inox 430.	20	C, F, U, NE, BL10, ZE, HL, 1013, 6002, 6005, 8017, 8019, 9001, 9005, 9010, 9016, BR801, BW21, GR217, GR606, RD501, WT005
1122.2/.3/.4/.5/.6/.7 1122.9/.10/.12/.13	Nueva versión con contraplaca dentada.	20	C, F, U, NE, BL10, ZE, HL, 1013, 6005, 8017, 8019, 9001, 9005, 9010, BR801, GR217, GR606, RD501, WT005
1122.11	Soporta: 2 bisagras 90 Kg, 3 bisagras 100 Kg.	20	C, F, U, NE, BL10, ZE, HL, 1013, 6005, 7032, 8017, 8019, 9001, 9005, 9010, BR801, BW21, GR217, GR606, RD501, WT005



Art.	Descripción	Unid.	Acabados
1122.200/.211	(patentado) Bisagra de 3 cuerpos en aluminio, pre-montada, casquillos en nylon, pernio extraíble pre-montado, pletinas y 6 tornillos TS M5x9 pre-montados en acero inox 430.	20	C, F, U, NE, BL10, ZE, HL, 1013, 6005, 8017, 8019, 9001, 9005, 9010, 9016, BR801, GR217, GR606, RD501, WT005
		10	PVD H, PVD X, XSD
1122.201	Soporta: 2 bisagras 90 Kg, 3 bisagras 100 Kg.	20	C, F, U, NE, BL10, ZE, HL, 1013, 1015, 6005, 8017, 8019, 9001, 9005, 9010, 9016, BR801, GR217, GR606, RD501, WT005
		10	PVD H, PVD X, XSD



Art.	Descripción	Unid.	Acabados
1123	(patentado) Bisagra de 2 alas en aluminio para la tercera hoja, casquillo de nylon, pernio, pletinas y 4 tornillos TSC M5x10 pre-montados en acero inox 430.	50	C, F, U, NE, BL10, ZE, HL, 1013, 6005, 7032, 8017, 8019, 9001, 9005, 9010, 9016, BR801, BW21, GR217, GR606, RD501, WT005, PVD H, PVD X, XSD
		20	PVD H, PVD X, XSD
1123.3/.5/.6/.7 1123.10/.13	Nueva versión con contraplaca dentada.	50	C, F, U, NE, BL10, ZE, HL, 1013, 6005, 8017, 8019, 9001, 9005, 9010, BR801, GR217, GR606, RD501, WT005
1123.9	Soporta: 2 bisagras 80 Kg, 3 bisagras 90 Kg.	50	C, F, U, NE, BL10, ZE, HL, 1013, 6005, 8017, 8019, 9001, 9005, 9010, BR801, BW21, GR217, GR606, RD501, WT005
1123.11		50	C, F, U, NE, BL10, ZE, HL, 1013, 6005, 7032, 8017, 8019, 9001, 9005, 9010, BR801, BW21, GR217, GR606, RD501, WT005
		20	PVD H, PVD X, XSD

MORSA DUE+

Bisagras para ventanas



Art.	Descripción	Unid.	Acabados
1115	(patentado) Bisagra de 2 alas en aluminio, 2 casquillos en nylon, pernio en acero zincado, pletinas y 4 tornillos TSC M5x10 pre-montados en acero inox 430.	50	C, F, U, NE, BL10, ZE, HL, 1013, 1015, 6005, 8017, 8019, 9001, 9005, 9010, 9016, BR801, GR217, GR606, RD501, WT005
1115.1	Nueva versión con diámetro más grande y contraplaca dentada (a excepción de 1115.3/.9).	50	C, F, U, NE, BL10, ZE, HL, 1013, 6005, 8017, 8019, 9001, 9005, 9010, 9016, BR801, GR217, GR606, RD501, WT005
1115.3/.9/.11/.13/.14 1115.15/.71/.73/.115	Soporta: 2 bisagras 60 Kg, 3 bisagras 70 Kg.	50	C, F, U, NE, BL10, ZE, HL, 1013, 6005, 8017, 8019, 9001, 9005, 9010, BR801, GR217, GR606, RD501, WT005
1115.12		50	C, F, U, NE, BL10, ZE, HL, 1013, 6005, 8017, 8019, 9001, 9005, 9010, BR801, GR217, GR50, GR606, RD501, WT005
1115.74/.75/.81 1115.83/.95	Como 1115 pero con pernio en acero inox.	50	C, F, U, NE, BL10, ZE, HL, 1013, 6005, 8017, 8019, 9001, 9005, 9010, BR801, GR217, GR606, RD501, WT005



Art.	Descripción	Unid.	Acabados
1116.1	(patentado) Bisagra de 2 alas en aluminio para la tercera hoja, 2 casquillos en nylon, pernio en acero zincado, pletinas y 4 tornillos TSC M5x10 pre-montados en acero inox 430.	50	C, F, U, NE, BL10, ZE, HL, 1013, 1015, 6005, 8017, 8019, 9001, 9005, 9010, 9016, BR801, GR217, GR606, RD501, WT005
1116.3/.9/.11/.13/.15	Nueva versión con diámetro más grande y contraplaca dentada (a excepción de 1116.3/.9). Soporta: 2 bisagras 60 Kg, 3 bisagras 70 Kg.	50	C, F, U, NE, BL10, ZE, HL, 1013, 6005, 8017, 8019, 9001, 9005, 9010, 9016, BR801, GR217, GR606, RD501, WT005
1116.75	Como 1116.1 pero con pernio en acero inox.	50	C, F, U, NE, BL10, ZE, HL, 1013, 6005, 8017, 8019, 9001, 9005, 9010, BR801, GR217, GR606, RD501, WT005

Leyenda Acabados

1013 = lacado marfil RAL
 1015 = lacado marfil oscuro RAL
 6002 = lacado verde hoja RAL
 7032 = lacado gris silíceo RAL
 8017 = lacado marrón RAL
 8019 = lacado café RAL
 9001 = lacado crema RAL
 9005 = lacado negro RAL
 9010 = lacado blanco RAL
 9016 = lacado blanco tipo "señalización" RAL
 BL10 = lacado negro mate

BSA = lacado blanco satinado
 C = bruto
 HL = oro anodizado brillante
 F = plata anodizada
 U = bronce anodizado
 NE = negro electrocolor
 ZE = café electrocolor
 BR801 = marrón marmóreo
 BW21 = lacado blanco hielo
 GALET 9660 = lacado gris
 GR217 = gris oscuro marmóreo

GR50 = lacado verde con efecto rugoso
 GR606 = verde marmóreo
 RD501 = rojo marmóreo
 WT005 = blanco gótico
 PVD H = tratamiento PVD ORO BRILLANTE
 PVD X = tratamiento PVD INOX SATINADO
 XSD = inox satinado

MORSA DUE+

Gama de las bisagras serie 1115

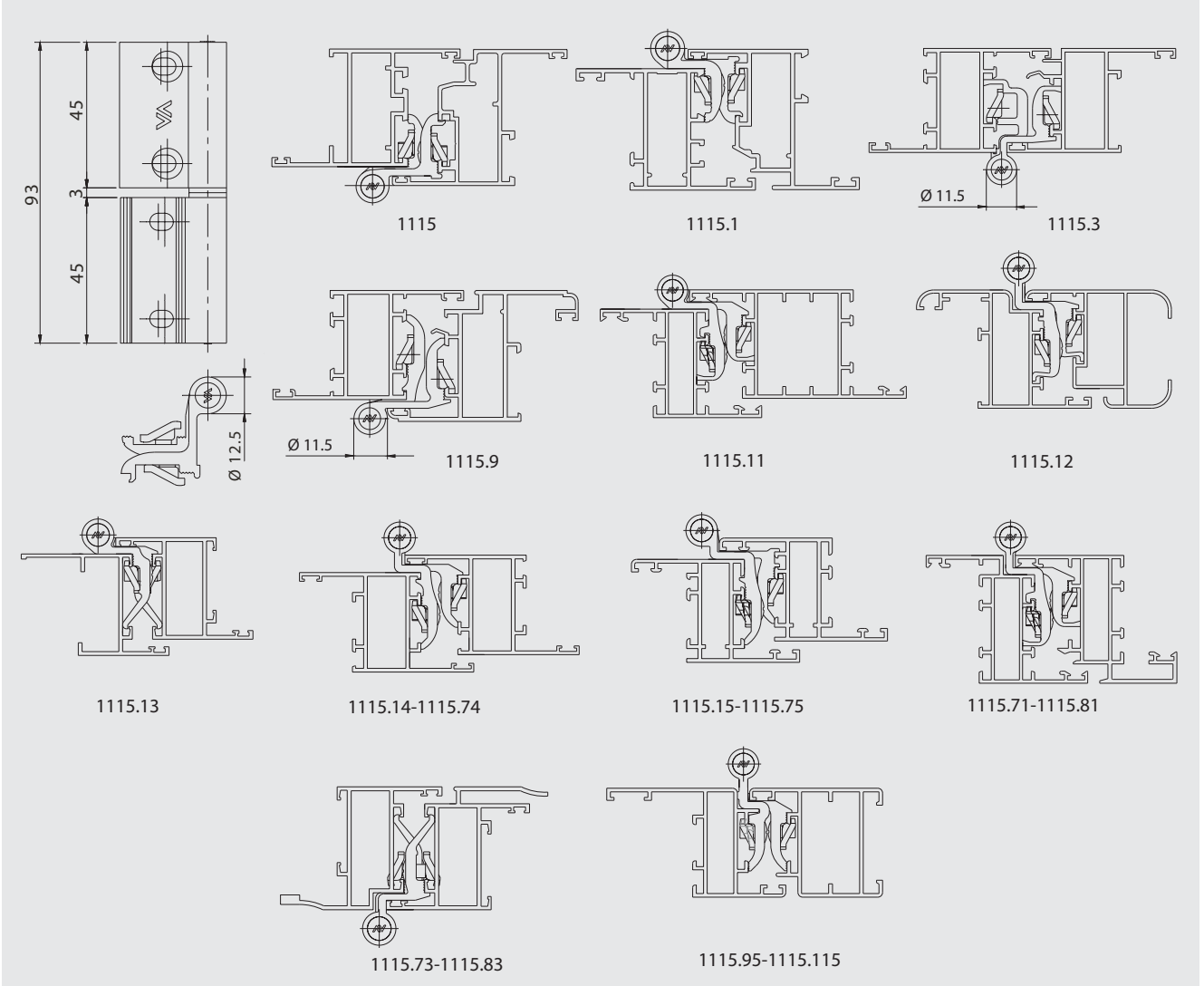

Gama de las bisagras serie 1116

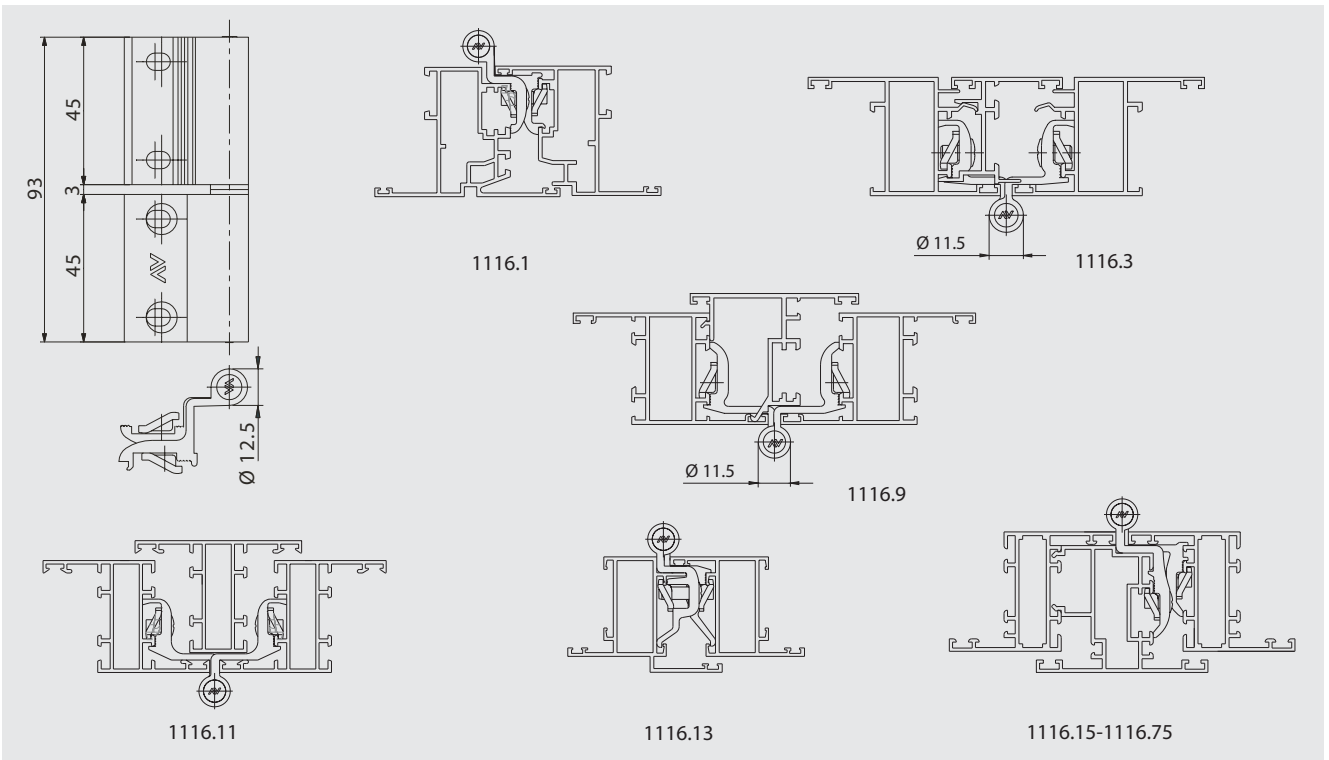

MORSA+

Gama de las bisagras serie 1121

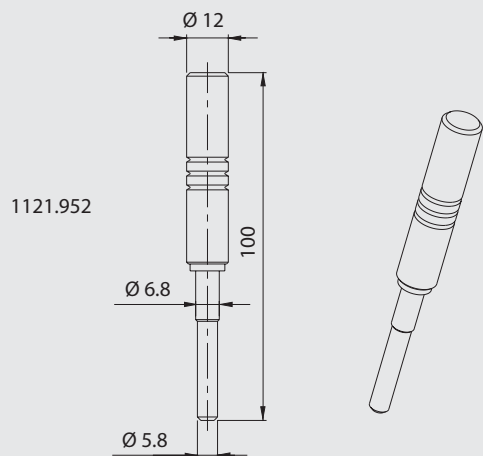
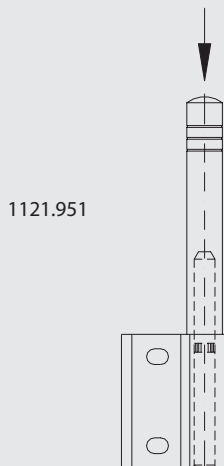
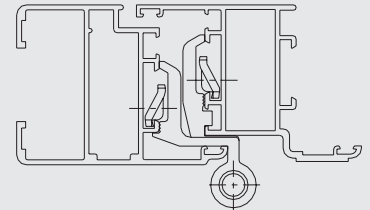
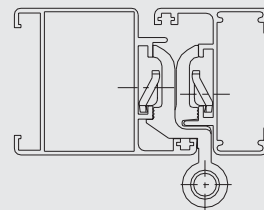
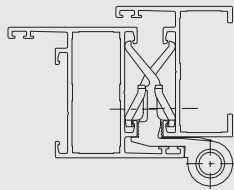
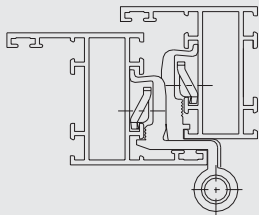
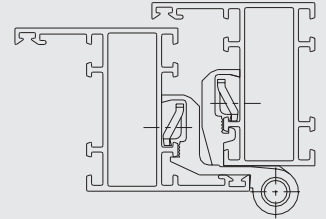
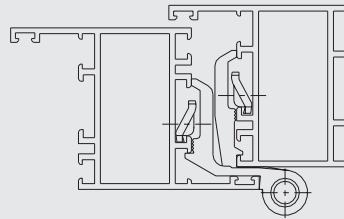
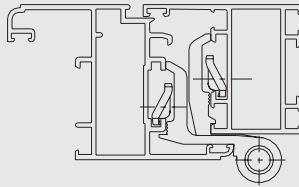
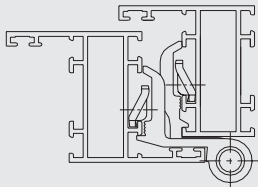
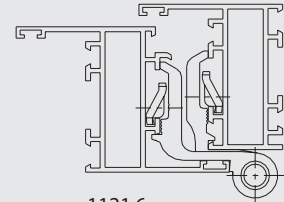
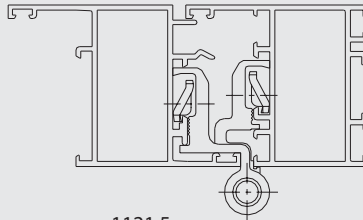
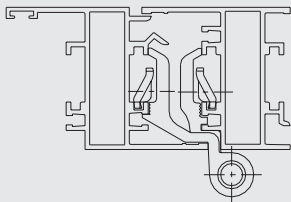
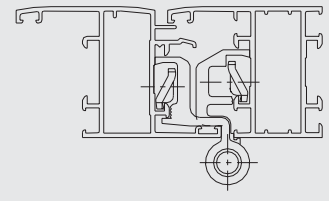
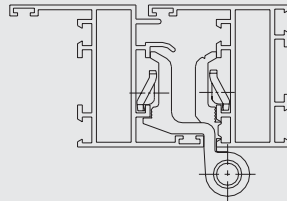
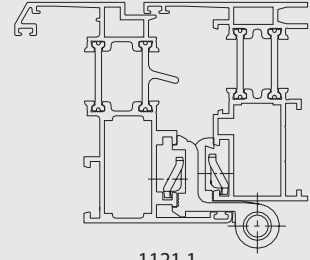
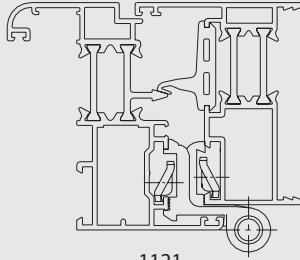
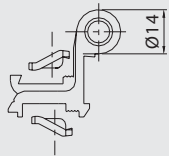
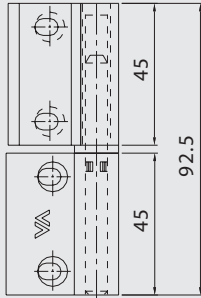

MORSA+

Gama de las bisagras serie 1122

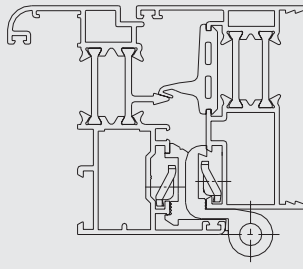
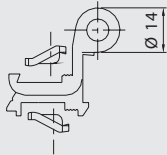
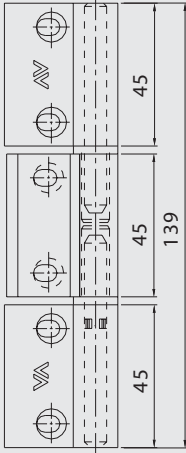

1122

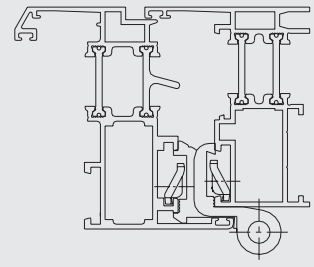

1122.1

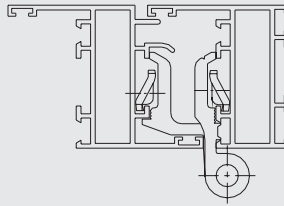

1122.2

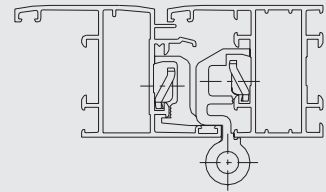

1122.3

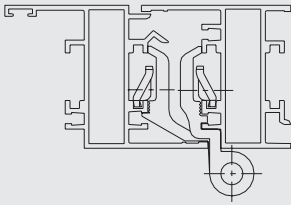

1122.4

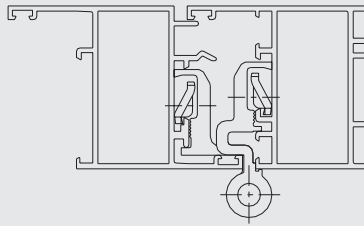

1122.5

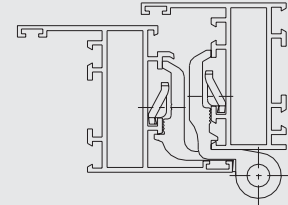

1122.6

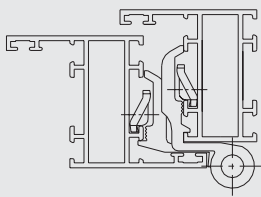

1122.7

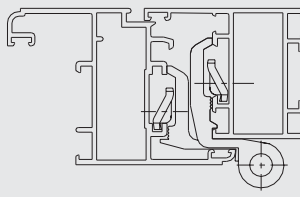

1122.9

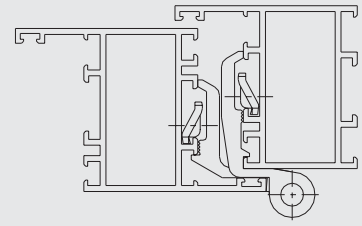

1122.10

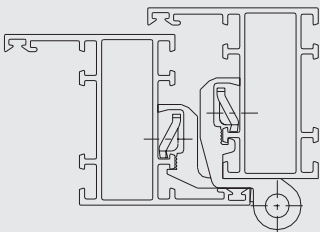

1122.11

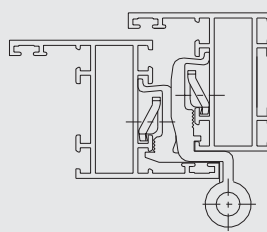

1122.12

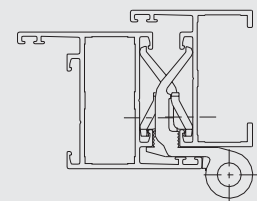

1122.13

Gama de las bisagras de 3 cuerpos

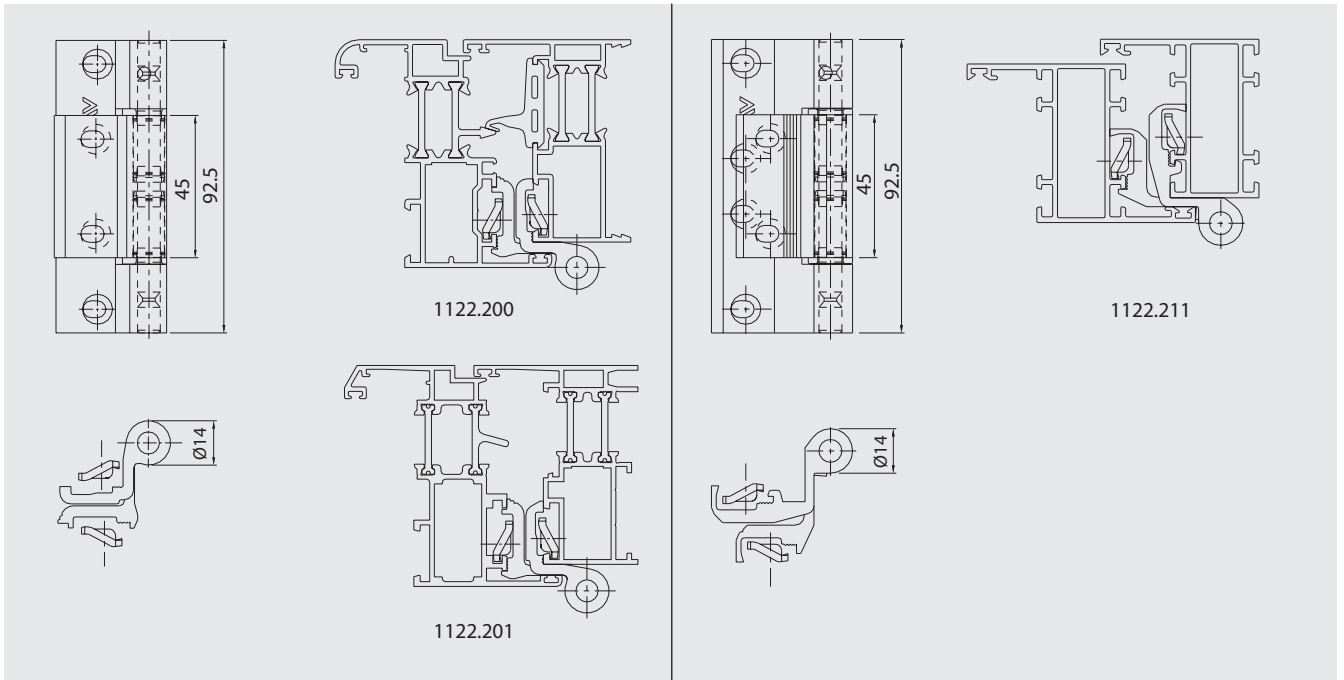

Gama de las bisagras serie 1123

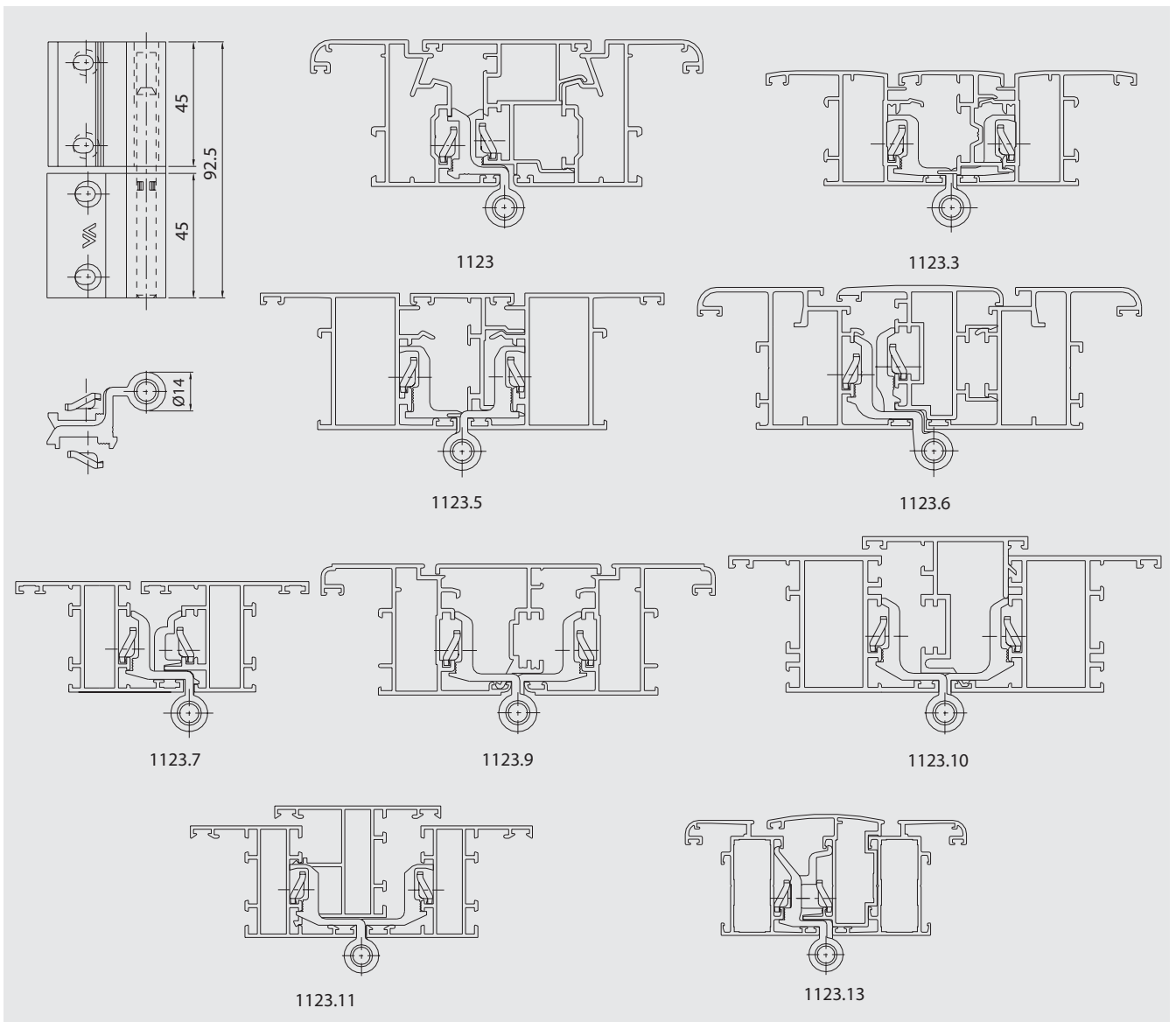

EXTRUSIONADOR	PERFIL																											
		1115-1121-1122-1122.200	1115.1-1121.1-1122.1-1122.201	1115.3-1116.3-1121.3-1122.3-1123.3	1115.9-1116.9-1121.9-1122.9-1123.9	1115.11-1121.11-1122.11-1122.211	1115.12-1121.12-1122.12	1115.13-1116.13	1115.14-1115.74	1115.15-1115.75-1116.15-1116.75	1115.71-1115.81	1115.73-1115.83	1115.95-1115.115	1116.1	1116.11-1123.11	1121.2-1122.2	1121.4-1122.4	1121.5-1122.5-1123.5	1121.6-1122.6-1123.6	1121.7-1122.7	1121.10-1122.10-1123.10	1121.13-1122.13-1123.13	1121.78	1121.79	1123	1123.7		
PASSERINI	EKIP 50 sorm.																											
	EKIP ev sorm.				●																							
	EKIP ev compl.			●																								
	EKIP THERMO 53			●																								
	VENICE TH16	●												●													●	
	MAASTRICHT LIGHT	●												●													●	
	MAASTRICHT 53	●												●													●	
	MAASTRICHT TH 60	●												●													●	
	MAASTRICHT TH 68	●												●													●	
PONZIO SUD	NEW TEC 50					●																						
	NEW TEC 52					●																						
	NEW TEC 60					●																						
	NEW TEC 68 ST					●																						
	WINDSTOP 45 by PONZIO	●												●													●	
	WINDSTOP 45 by PONZIO ragg.													●													●	
	WINDSTOP 45 TT by PONZIO	●												●													●	
WINDSTOP 45 TT by PONZIO ragg.													●													●		
PROFILATI	EKU 40	●											●														●	
	EKU 53	●											●														●	
	EKU 53 ragg.												●														●	
	EKU 53 TT	●											●														●	
	EKU 64 TT	●											●														●	
	EKU 72 TT	●											●														●	
	EKU COMPACT												●														●	
	PE 40								●											●								●
	PE 40 ragg.								●																			●
	PE 50								●												●							●
	PE 58 TT sorm.								●												●							●

NOTA: las bisagras pre-montadas a DERECHAS o IZQUIERDAS, artículos 1121 D, 1121.1 D, 1121.11 D, 1121 S, 1121.1 S y 1121.11 S, se adaptan a los mismos perfiles que las bisagras 1121, 1121.1 y 1121.11.

SAVIO -PTA. puede cambiar en cualquier momento y sin previo aviso las características técnicas de los productos presentados dentro de este catálogo .



Plataforma Logística Zaragoza - PLA-ZA

Calle Pertusa, 5 naves 1-3

50197 Zaragoza (ESPAÑA)

Tel. (+34) 976 529 044

Fax (+34) 976 527 525

www.ptaherrajes.com