



**DUAL  
POWER**  
choose your battery

**POWERPLUS**<sup>®</sup>  
HIGH QUALITY TOOLS



# 100+

## DUAL POWER & GARDEN TOOLS

The Dual Power product range was developed with the DIYer in mind who's looking for eco-friendly, cordless and powerful. It offers 100+ power and garden tools that can be powered by the same 20 V or 2x20 V battery. Discover the extensive product range in this catalogue.

## 20V and 2x20V BATTERY RANGE

The platform consists of 2 battery types:

- 20 V: a standard battery pack which consists of 5 li-ion cells
- 2x20 V: a battery pack with double the amount of cells compared to the 20 V battery pack. In other words, one housing with 2 battery packs or 2x20 V.



The 2x20 V batteries fit all tools, no matter the amperage, and ensure an even longer working time when used on a 20 V tool. The 20 V batteries are only compatible with the 20 V tools.

## ONE CHARGER



The Dual Power charger was developed to be able to charge all Dual Power batteries quickly and efficiently. The batteries and chargers can be acquired separately or as part of a starter kit, as all Dual Power tools are compatible with this one battery platform. That makes Dual Power both economic and ecological because you won't need a different battery for each tool.



## **ONE PLATFORM, TWO RANGES, ENDLESS POSSIBILITIES**

Battery platforms have become increasingly popular as users save costs by no longer having to buy unnecessary batteries and chargers.

That is why Powerplus has developed a platform aimed to cover the majority of needs in the DIY and garden market. Go for cordless and powerful with the Dual Power line: an extensive range of durable, battery-powered power tools and garden tools.

The majority of battery platforms in the market can operate one specific range of tools, whereas Dual Power is designed to offer more flexibility and possibilities.

**One battery platform, two ranges of 20 V and 40 V power tools and garden tools.**

Depending on the project, your budget and the power needed, you will find the tool for you in the Dual Power range.

**DUAL POWER'S RANGE OF 100+ TOOLS NOT ONLY OFFERS ENDLESS POSSIBILITIES TO ANY DIY'ER OR PROFESSIONAL BUT ALSO PROVIDES THE FLEXIBILITY OF CORDLESS TOOLS.**

**[WWW.DUAL-POWER.COM](http://WWW.DUAL-POWER.COM)**





## BATTERIES, CHARGER AND SETS

POWDP9021	BATTERY 20V LI-ION	2.0Ah	p. 7
POWDP9023	BATTERY 20V LI-ION	3.0Ah	p. 7
POWDP9024	BATTERY 20V LI-ION	4.0Ah	p. 7
POWDP9037	BATTERY 2x20V LI-ION	2.5Ah	p. 7
POWDP9040	BATTERY 2x20V LI-ION	4.0Ah	p. 7
POWDP9051	CHARGER		p. 8
POWDP9062	CHARGER + BATTERY 20V LI-ION	2.0Ah	p. 8
POWDP9063	CHARGER + BATTERY 20V LI-ION	3.0Ah	p. 9
POWDP9064	CHARGER + BATTERY 2x20V LI-ION	2.5Ah	p. 9

## POWER TOOLS

POWDP15100	DRILL/SCREWDRIVER	20V	p. 12
POWDP15200	IMPACT DRILL/SCREWDRIVER	20V	p. 12
POWDP15210	IMPACT DRILL/SCREWDRIVER + CHARGER + BATTERY 20V LI-ION 2.0Ah	20V	p. 13
POWDP15220	IMPACT DRILL/SCREWDRIVER	20V	p. 13
POWDP15300	DRILL/SCREWDRIVER + CHARGER + BATTERY 20V LI-ION 2.0Ah + 78 ACCESSORIES	20V	p. 16
POWDP15301	DRILL/SCREWDRIVER + CHARGER + 2x BATTERY 20V LI-ION 2.0Ah + 78 ACCESSORIES	20V	p. 16
POWDP15600	HAMMER DRILL	20V	p. 17
POWDP15630	HAMMER DRILL	20V	p. 17
POWDP15640	HAMMER DRILL + CHARGER + BATTERY 20V LI-ION 2.0Ah	20V	p. 18
POWDP15680	HAMMER DRILL	40V	p. 18
POWDP20100	IMPACT SCREWDRIVER	20V	p. 19
POWDP20150	IMPACT WRENCH	20V	p. 19
POWDP20160	IMPACT WRENCH + CHARGER + BATTERY 20V LI-ION 2.0Ah	20V	p. 20
POWDP20400	IMPACT WRENCH	40V	p. 20
POWDP25100	RECIPROCATING SAW	20V	p. 21

POWDP25110	RECIPROCATING SAW + CHARGER + BATTERY 20V LI-ION 2.0Ah	20V	p. 21
POWDP25200	CIRCULAR SAW	20V	p. 22
POWDP25230	CIRCULAR SAW	40V	p. 22
POWDP25260	CIRCULAR SAW	40V	p. 23
POWDP25400	PLUNGE SAW	20V	p. 23
POWDP25300	JIGSAW	20V	p. 24
POWDP25310	JIGSAW + CHARGER + BATTERY 20V LI-ION 2.0Ah	20V	p. 24
POWDP2550	MITRE SAW	20V	p. 25
POWDP2560	TELESCOPIC MITRE SAW	20V	p. 26
POWDP2580	TABLE SAW	40V	p. 27
POWDP75100	TILE CUTTER	20V	p. 27
POWDP35100	ANGLE GRINDER	20V	p. 28
POWDP35150	ANGLE GRINDER + CHARGER + BATTERY 2x20V LI-ION 2.5Ah	20V	p. 28
POWDP35170	ANGLE GRINDER	40V	p. 29
POWDP4050	PLANER	20V	p. 29
POWDP4060	OSCILLATING MULTITOOL	20V	p. 30
POWDP75300	ROTARY MULTITOOL	20V	p. 30
POWDP4070	ANGLE POLISHER	20V	p. 31
POWDP4040	POLISHER	20V	p. 31
POWDP50200	PALM SANDER	20V	p. 32
POWDP50300	FINISHING SANDER	20V	p. 32
POWDP50400	ECCENTRIC SANDER	20V	p. 33
POWDP50700	FILE/BELT SANDER	20V	p. 33
POWDP6020	ASH CLEANER	20V	p. 34
POWDP6030	HANDHELD VACUUM CLEANER	20V	p. 35
POWDP6040	VACUUM CLEANER WET/DRY	20V	p. 36
POWDP6050	VACUUM CLEANER WET/DRY	20V	p. 37
POWDP60810	COFFEE MACHINE	40V	p. 38
POWDP7010	STAPLER/NAILER	20V	p. 39
POWDP7020	AIR PUMP	20V	p. 39
POWDP7050	CAULKING GUN	20V	p. 40
POWDP7080	CONCRETE/PAINT MIXER	20V	p. 40



POWDP7060	SOLDERING IRON	20V	p. 41
POWDP7030	INFLATOR/DEFLATOR	20V	p. 42
POWDP7070	COMPRESSOR	40V	p. 43
POWDP77100	BISCUIT JOINER	40V	p. 44
POWDP8015	CORDLESS FAN	20V	p. 44
POWDP8030	PORTABLE FLOODLIGHT	20V	p. 45
POWDP8035	PORTABLE FLOODLIGHT WITH TRIPOD	20V	p. 46

### GARDEN TOOLS

POWDPG7521	LEAF BLOWER	20V	p. 48
POWDPG7526	LEAF BLOWER	40V	p. 48
POWDPG75270	LEAF BLOWER/VACUUM	40V	p. 49
POWDPG7531	HEDGE TRIMMER	20V	p. 50
POWDPG75320	HEDGE TRIMMER + CHARGER + BATTERY 20V LI-ION 2.0Ah	20V	p. 50
POWDPG7536	HEDGE TRIMMER	40V	p. 51
POWDPG75300	TELESCOPIC GRASS/SHRUB SHEARS	20V	p. 52
POWDPG75380	TELESCOPIC HEDGE TRIMMER	40V	p. 53
POWDPG7541	GRASS TRIMMER	20V	p. 54
POWDPG75420	GRASS TRIMMER + CHARGER + BATTERY 20V LI-ION 2.0Ah	20V	p. 54
POWDPG7546	GRASS TRIMMER	40V	p. 55
POWDPG7551	BRUSH CUTTER	40V	p. 56
POWDPG7553	4-IN-1 GARDEN MULTITOOL	40V	p. 57
POWDPG75561	LAWNMOWER	20V	p. 60
POWDPG75565	LAWNMOWER + GRASS TRIMMER + CHARGER + BATTERY 2x20V LI-ION 2.5Ah	20V 20V	p. 61
POWDPG75610	LAWNMOWER	40V	p. 62
POWDPG75621	LAWNMOWER + GRASS TRIMMER + CHARGER + BATTERY 2x20V LI-ION 2.5Ah	40V 20V	p. 63
POWDPG7568	LAWNMOWER DOUBLE BATTERY	40V	p. 64
POWDPG7572	CORDLESS PRUNER SAW	20V	p. 65
POWDPG7570	CHAINSAW	20V	p. 66

POWDPG7576	CHAINSAW	40V	p. 66
POWDPG75385	TELESCOPIC CHAINSAW	40V	p. 67
POWDPG8020	LAWN SCARIFIER/AERATOR	40V	p. 68
POWDPG80400	PRESSURE SPRAYER	20V	p. 69
POWDPG80460	PRESSURE SPRAYER	20V	p. 69
POWDPG80620	HIGH PRESSURE CLEANER	20V	p. 70
POWDPG80621	HIGH PRESSURE CLEANER + CHARGER + BATTERY 20V LI-ION 2.0Ah	20V	p. 72
POWDPG8060	WEED SWEEPER	20V	p. 73

### ACCESSORIES

p. 74

### TOOL BOXES

POWDPTB01	TOOLBOX MEDIUM	p. 75
POWDPTB02	TOOLBOX LARGE	p. 75
POWDPBAG01	TOOL BAG	p. 75

# 1000

**+**  
**TOOLS**



**ONE PLATFORM, TWO RANGES,  
ENDLESS POSSIBILITIES**

**INTENSIVE USE | FLEXIBLE | BATTERY PLATFORM | ECO-FRIENDLY**



**ONE  
CHARGER**

**20V OR  
2x20V  
BATTERY**

**TWO RANGES OF  
20V AND 40V  
POWER AND GARDEN TOOLS**

# THE DUAL POWER BATTERY RANGE

all the power you need

## 20V

a standard battery pack which consists of 5 li-ion cells



COMPATIBLE WITH



## 2x20V

two standard battery packs in one housing



COMPATIBLE WITH



### 20V LI-ION BATTERY FOR 20V TOOLS ONLY

POWDP9021



2000mAh CAPACITY



POWDP9023



3000mAh CAPACITY



POWDP9024



4000mAh CAPACITY



### 2x20V LI-ION BATTERY FOR 40V and 20V TOOLS

POWDP9037



2500mAh CAPACITY on a 40V TOOL  
5000mAh CAPACITY on a 20V TOOL



POWDP9040



4000mAh CAPACITY on a 40V TOOL  
8000mAh CAPACITY on a 20V TOOL



**POWDP9051**

**CHARGER**

LADER - CHARGEUR - LADEGERÄT  
CARGADOR - CARICABATERIE

CHARGER OUTPUT

21V ~ / 4.0A

CABLE LENGTH

1.8m

CHARGING TIME 20V BATTERY

40min

CHARGING TIME 2x20V BATTERY

2h



**20V**  
BATTERY  
CHARGING  
TIME



**2x20V**  
BATTERY  
CHARGING  
TIME



21V ~ / 4.0A  
CHARGER OUTPUT



1.8m  
CABLE



**POWDP9062**

**CHARGER + BATTERY 20V 2.0Ah FOR 20V TOOLS**

LADER + BATTERIJ 20V (20V TOOLS)  
CHARGEUR + BATTERIE 20V (OUTILS 20V)  
LADEGERÄT + AKKU 20V (20V GERÄTE)  
CARGADOR + BATERÍA 20V (HERRAMIENTAS 20V)  
CARICABATERIE + BATERIA 20V (UTENSILI 20V)

CHARGER OUTPUT

21V ~ / 4.0A

CABLE LENGTH

1.8m

CHARGING TIME 20V BATTERY

40min

CHARGING TIME 2x20V BATTERY

2h



RATED VOLTAGE

20V ~

BATTERY CAPACITY

2000mAh

BATTERY TYPE

Li-ion

COMPATIBLE WITH

20V TOOLS ONLY



MAX. 20V ~  
RATED VOLTAGE



2000mAh  
CAPACITY



LITHIUM-ION  
BATTERY TYPE





**POWDP9063**

**CHARGER + BATTERY 20V 3.0Ah FOR 20V TOOLS**

LADER + BATTERIJ 20V (20V TOOLS)  
CHARGEUR + BATTERIE 20V (OUTILS 20V)  
LADEGERÄT + AKKU 20V (20V GERÄTE)  
CARGADOR + BATERÍA 20V (HERRAMIENTAS 20V)  
CARICABATTERIE + BATTERIA 20V (UTENSILI 20V)

CHARGER OUTPUT  
**21V ~ / 4.0A**

CABLE LENGTH  
**1.8m**

CHARGING TIME 20V BATTERY  
**40min**

CHARGING TIME 2x20V BATTERY  
**2h**

RATED VOLTAGE  
**20V ~**

BATTERY CAPACITY  
**3000mAh**

BATTERY TYPE  
**Li-ion**

COMPATIBLE WITH  
**20V TOOLS ONLY**



**MAX. 20V ~**  
RATED VOLTAGE



**3000mAh**  
CAPACITY



**LITHIUM-ION**  
BATTERY TYPE

5 400338 097294

**POWDP9064**

**CHARGER + BATTERY 2x20V 2.5Ah FOR 40V and 20V TOOLS**

LADER + BATTERIJ 2x20V (40V & 20V TOOLS)  
CHARGEUR + BATTERIE 2x20V (OUTILS 40V & 20V)  
LADEGERÄT + AKKU 2x20V (40V & 20V GERÄTE)  
CARGADOR + BATERÍA 2x20V (HERRAMIENTAS 40V & 20V)  
CARICABATTERIE + BATTERIA 2x20V (UTENSILI 40V & 20V)

CHARGER OUTPUT  
**21V ~ / 4.0A**

CABLE LENGTH  
**1.8m**

CHARGING TIME 20V BATTERY  
**40min**

CHARGING TIME 2x20V BATTERY  
**2h**

RATED VOLTAGE  
**2x20V ~**

BATTERY CAPACITY  
**2500mAh** on a 40V TOOL  
**5000mAh** on a 20V TOOL

BATTERY TYPE  
**Li-ion**

COMPATIBLE WITH  
**40V AND 20V TOOLS**



**MAX. 2x20V ~**  
RATED VOLTAGE



**5000mAh**  
CAPACITY ON A 20V TOOL



**2500mAh**  
CAPACITY ON A 40V TOOL



**LITHIUM-ION**  
BATTERY TYPE

5 400338 090912



## BATTERY TECHNOLOGY

The higher the capacity, the longer a battery will run. The 20V battery has a capacity of 2000mAh, 3000mAh or 4000mAh. The 2x20V battery has a capacity of 2500 or 4000mAh when used on a 40V tool, but delivers an impressive 5000 or 8000mAh when combined with a 20V tool.

How is this possible? The 2x20V battery lends itself to both a series or parallel connection of its Li-ion cells. In a series connection (2x20V battery on 40V tool), each cell adds its voltage potential to obtain the double voltage of 2x20V. By connecting the Li-ion cells in parallel (2x20V battery on 20V tool), the result is an output with a double capacity: it will boost the capacity from 4000mAh to 8000mAh.

### 20V BATTERY FOR 20V TOOLS

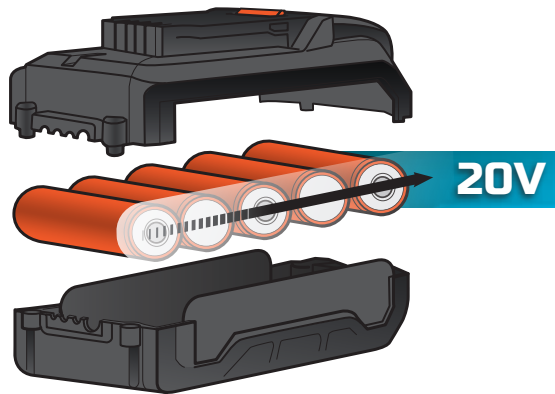

### 2x20V BATTERY FOR 20V & 40V TOOLS 2x 20V BATTERY PACK INSIDE

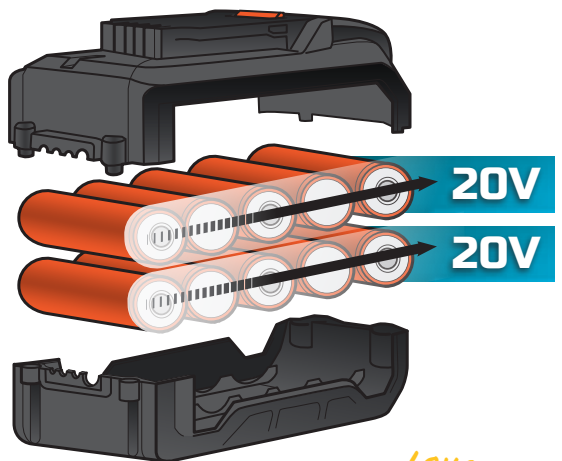

A 20V tool uses each pack one after the other

*LONGER WORKING TIME*

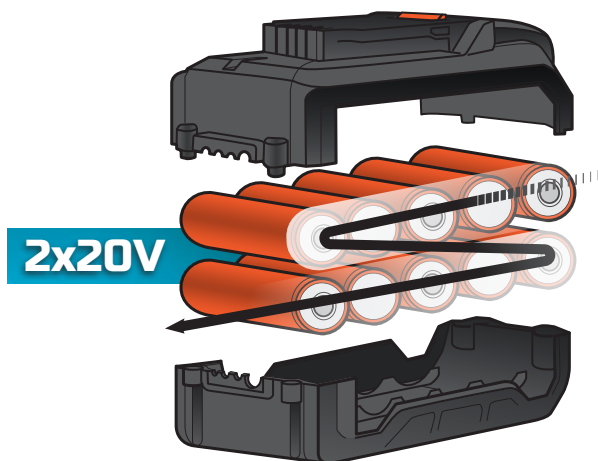

A 40V tool uses both packs together



**DUAL  
POWER**  
choose your battery

**POWER TOOLS**



**POWDP15100**

## DRILL/SCREWDRIVER

SCHROEFBOORMACHINE - PERCEUSE/VISSEUSE - BOHRSCHRAUBER  
TALADRO/ATORNILLADOR - TRAPANO

**20  
VOLT  
TOOL**

COMPATIBLE  
WITH



AND



RATED VOLTAGE  
**20V**

ROTATION SPEED  
**0-450min<sup>-1</sup> / 0-1800min<sup>-1</sup>**

CHUCK TYPE  
**Max. Ø13mm keyless chuck**

MAX. TORQUE  
**50Nm**

2 FUNCTIONS  
**screwing, drilling**



5 400338 092510

**POWDP15200**

## IMPACT DRILL/SCREWDRIVER

SLAGSCHROEFBOORMACHINE - PERCEUSE/VISSEUSE À PERCUSSION - SCHLAGBOHRSCHRAUBER  
TALADRO/ATORNILLADOR DE IMPACTO - TRAPANO A PERCUSSIONE

**20  
VOLT  
TOOL**

COMPATIBLE  
WITH



AND



RATED VOLTAGE  
**20V**

ROTATION SPEED  
**0-450min<sup>-1</sup> / 0-1800min<sup>-1</sup>**

IMPACT RATE  
**0-7200ipm / 0-28800ipm**

CHUCK TYPE  
**Max. Ø13mm keyless chuck**

MAX. TORQUE  
**50Nm**

3 FUNCTIONS  
**screwing, drilling, impact drilling**

DRILL CAPACITY  
**wood 25mm  
steel 10mm / concrete 10mm**



5 400338 092442

POWDP15210

**IMPACT DRILL/SCREWDRIVER** + 1 CHARGER  
+ 1 BATTERY 20V LI-ION

**PROMO PACK**

SLAGSCHROEFBOORMACHINE + LADER + BATTERIJ 20V LI-ION  
PERCEUSE/VISSEUSE À PERCUSSION + CHARGEUR + BATTERIE 20V LI-ION  
SCHLAGBOHRSCRAUBER + LADEGERÄT + AKKU 20V LI-ION  
TALADRO/ATORNILLADOR DE IMPACTO + CARGADOR + BATERÍA 20V LI-ION  
TRAPANO A PERCUSSIONE + CARICABATTERIE + BATTERIA 20V LI-ION

**20 VOLT TOOL**

COMPATIBLE WITH



AND

INCLUDED IN THIS PROMO PACK:

**POWDP15200:** IMPACT DRILL/  
SCREWDRIVER

**POWDP9021:** BATTERY 20V= 2.0Ah

**POWDP9051:** CHARGER 4.0A

STORAGE CASE



5 400338 092466 >

POWDP15220

**IMPACT DRILL/SCREWDRIVER**

SLAGSCHROEFBOORMACHINE - PERCEUSE/VISSEUSE À PERCUSSION - SCHLAGBOHRSCRAUBER  
TALADRO/ATORNILLADOR DE IMPACTO - TRAPANO A PERCUSSIONE

**20 VOLT TOOL**

COMPATIBLE WITH



AND

RATED VOLTAGE  
20V =

ROTATION SPEED  
0-500min<sup>-1</sup> / 0-2000min<sup>-1</sup>

IMPACT RATE  
0-8000ipm / 0-32000ipm

CHUCK TYPE  
Max. Ø13mm keyless chuck

MAX. TORQUE  
65Nm

3 FUNCTIONS  
screwing, drilling, impact drilling

DRILL CAPACITY  
wood 30mm  
steel 10mm / concrete 10mm

**BRUSHLESS MOTOR**

**BRUSHLESS MOTOR**

**ADVANTAGES  
COMPARED TO A BRUSHED MOTOR**

- +50% LIFETIME
- +50% AUTONOMY
- +50% POWER



5 400338 092459 >

# BRUSHLESS MOTOR



## DISCOVER OUR EXTENSIVE RANGE OF BRUSHLESS TOOLS.

A brushless motor is a DC electric motor that functions without carbon brushes. Therefore it needs less maintenance, while having a longer lifespan.

The brushless motor extends the battery's runtime up to 50%.



**DUAL  
POWER**  
choose your battery

# ADVANTAGES COMPARED TO A BRUSHED MOTOR

+50%  
LIFETIME

+50%  
AUTONOMY

+50%  
POWER



POWDP15300

**DRILL/SCREWDRIVER** + 1 CHARGER  
+ 1 BATTERY 20V LI-ION

**NEW**

**PROMO PACK**

SCHROEFBOORMACHINE + LADER + BATTERIJ 20V - PERCEUSE/VISSEUSE + CHARGEUR + BATTERIE 20V  
BOHRSCRAUBER + LADEGERÄT + AKKUPACK 20V - TALADRO/ATORNILLADOR + CARGADOR + BATERÍA 20V  
TRAPANO + CARICABATTERIE + BATTERIA 20V

EXPECTED 2023

**20 VOLT TOOL**

COMPATIBLE WITH



AND



RATED VOLTAGE  
20V  $\approx$

ROTATION SPEED

0-400min<sup>-1</sup> / 0-1550min<sup>-1</sup>

CHUCK TYPE

Max.  $\varnothing$ 13mm keyless chuck

MAX. TORQUE

40Nm

2 FUNCTIONS

screwing, drilling

BATTERY

20V  $\approx$  - 2.0Ah

CHARGER OUTPUT

21V  $\approx$  / 4.0A

STORAGE CASE

14x HSS metal drill

1.5/1.5/2/2.5/3/3/3.5  
4/4.5/5/5.5/6/6.5mm

5x wood drill

4/5/6/8/10mm

8x socket

6/7/8/9/10/11/12/13mm

1x counter sink

1x centre punch 100mm

1x knife cutter

3x spare blade

1x carpenter's pencil

2x extra lead-core

1x measuring tape 5m

20x 25mm bit

⊖ SL 4/5/6

⊕ PH 1/2/2/3

⊕ PZ 1/2/2/2/3

⊖ T 15/20/25/30

⊖ H 3/4/5/6

10x 50mm bit

⊖ SL 4/5/6

⊕ PZ 1/2/3

⊖ T 15/20/25/30

10x 75mm bit

⊖ SL 4/5/6

⊕ PZ 1/2/3

⊖ T 15/20/25/30

1x magnetic bit holder 60mm

+78 ACC.

1 BATTERY INCLUDED



5 4003381097621

POWDP15301

**DRILL/SCREWDRIVER** + 1 CHARGER  
+ 2x BATTERY 20V LI-ION

**NEW**

**PROMO PACK**

SCHROEFBOORMACHINE + LADER + 2x BATTERIJ 20V - PERCEUSE/VISSEUSE + CHARGEUR + 2x BATTERIE 20V  
BOHRSCRAUBER + LADEGERÄT + 2x AKKUPACK 20V - TALADRO/ATORNILLADOR + CARGADOR + 2x BATERÍA 20V  
TRAPANO + CARICABATTERIE + 2x BATTERIA 20V

EXPECTED 2023

**20 VOLT TOOL**

COMPATIBLE WITH



AND



RATED VOLTAGE  
20V  $\approx$

ROTATION SPEED

0-400min<sup>-1</sup> / 0-1550min<sup>-1</sup>

CHUCK TYPE

Max.  $\varnothing$ 13mm keyless chuck

MAX. TORQUE

40Nm

2 FUNCTIONS

screwing, drilling

2x BATTERY

20V  $\approx$  - 2.0Ah

CHARGER OUTPUT

21V  $\approx$  / 4.0A

STORAGE CASE

14x HSS metal drill

1.5/1.5/2/2.5/3/3/3.5  
4/4.5/5/5.5/6/6.5mm

5x wood drill

4/5/6/8/10mm

8x socket

6/7/8/9/10/11/12/13mm

1x counter sink

1x centre punch 100mm

1x knife cutter

3x spare blade

1x carpenter's pencil

2x extra lead-core

1x measuring tape 5m

20x 25mm bit

⊖ SL 4/5/6

⊕ PH 1/2/2/3

⊕ PZ 1/2/2/2/3

⊖ T 15/20/25/30

⊖ H 3/4/5/6

10x 50mm bit

⊖ SL 4/5/6

⊕ PZ 1/2/3

⊖ T 15/20/25/30

10x 75mm bit

⊖ SL 4/5/6

⊕ PZ 1/2/3

⊖ T 15/20/25/30

1x magnetic bit holder 60mm

+78 ACC.

2 BATTERIES INCLUDED



5 4003381098055



**POWDP15600**

**HAMMER DRILL**

BOORHAMER - MARTEAU PERFORATEUR - BOHRHAMMER  
MARTILLO PERFORADOR - MARTELLO PERFORATORE

**20 VOLT TOOL**

COMPATIBLE WITH



AND



RATED VOLTAGE  
**20V**

ROTATION SPEED  
**0-850min<sup>-1</sup>**

IMPACT RATE  
**0-5500ipm**

CONNECTION  
**SDS PLUS-type**

IMPACT ENERGY  
**1.3J**

3 FUNCTIONS  
**drilling, hammer drilling, screwing**

DRILL CAPACITY  
**wood 16mm  
steel 10mm / concrete 13mm**



NOT INCLUDED  
NIET INBEGREPEN  
NON INCLUS  
NICHT ENTHALTEN  
NO INCLUIDO  
NON INCLUSO



5 400338 092534

**POWDP15630**

**HAMMER DRILL**

BOORHAMER - MARTEAU PERFORATEUR - BOHRHAMMER  
MARTILLO PERFORADOR - MARTELLO PERFORATORE

**20 VOLT TOOL**

COMPATIBLE WITH



AND



RATED VOLTAGE  
**20V**

ROTATION SPEED  
**0-1350min<sup>-1</sup>**

IMPACT RATE  
**0-4750ipm**

CONNECTION  
**SDS PLUS-type**

IMPACT ENERGY  
**3J**

4 FUNCTIONS  
**drilling, hammer drilling,  
chisel rotation, chiseling**

DRILL CAPACITY  
**wood 30mm  
steel 13mm / concrete 22mm**

**BRUSHLESS MOTOR**



NOT INCLUDED  
NIET INBEGREPEN  
NON INCLUS  
NICHT ENTHALTEN  
NO INCLUIDO  
NON INCLUSO

**BRUSHLESS MOTOR**

**ADVANTAGES COMPARED TO A BRUSHED MOTOR**

- +50% LIFETIME**
- +50% AUTONOMY**
- +50% POWER**



**INCLUDED ACCESSORIES:**  
1x CHISEL - SDS PLUS TYPE - FLAT - 20x250mm  
1x CHISEL - SDS PLUS TYPE - POINTED - 250mm  
1x DRILL BIT - SDS PLUS TYPE - Ø 10x150mm  
1x DRILL BIT - SDS PLUS TYPE - Ø 6x150mm  
1x DRILL BIT - SDS PLUS TYPE - Ø 8x150mm

5 400338 092527

POWDP15640

**HAMMER DRILL** + 1 CHARGER  
+ 1 BATTERY 20V LI-ION

BOORHAMER + LADER + BATTERIJ 20V LI-ION  
MARTEAU PERFORATEUR + CHARGEUR + BATTERIE 20V LI-ION  
BOHRHAMMER + LADEGERÄT + AKKU 20V LI-ION  
MARTILLO PERFORADOR + CARGADOR + BATERÍA 20V LI-ION  
MARTELO PERFORATORE + CARICABATTERIE + BATTERIA 20V LI-ION

**PROMO PACK**

**20 VOLT TOOL**

COMPATIBLE WITH



AND



INCLUDED IN THIS PROMO PACK:

POWDP15630: HAMMER DRILL

POWDP9021: BATTERY 20V= 2.0Ah

POWDP9051: CHARGER 4.0A

STORAGE CASE



INCLUDED ACCESSORIES:

- 1x CHISEL - SDS PLUS TYPE - FLAT - 20x250mm
- 1x CHISEL - SDS PLUS TYPE - POINTED - 250mm
- 1x DRILL BIT - SDS PLUS TYPE - Ø 10x150mm
- 1x DRILL BIT - SDS PLUS TYPE - Ø 6x150mm
- 1x DRILL BIT - SDS PLUS TYPE - Ø 8x150mm



**BRUSHLESS MOTOR**



**ADVANTAGES**  
COMPARED TO A BRUSHED MOTOR

- +50% LIFETIME
- +50% AUTONOMY
- +50% POWER

5 400338 092701

POWDP15680

**HAMMER DRILL**

BOORHAMER - MARTEAU PERFORATEUR - BOHRHAMMER  
MARTILLO PERFORADOR - MARTELO PERFORATORE

**40 VOLT TOOL**

COMPATIBLE WITH



RATED VOLTAGE  
40V =

ROTATION SPEED  
0-1050min<sup>-1</sup>

IMPACT RATE  
0-4800ipm

CONNECTION  
SDS PLUS-type

IMPACT ENERGY  
5J

4 FUNCTIONS  
drilling, hammer drilling,  
chisel rotation, chiseling

DRILL CAPACITY  
wood 25mm / steel 10mm  
stone 20mm / concrete 26mm

**BRUSHLESS MOTOR**

STORAGE CASE

**BRUSHLESS MOTOR**



**ADVANTAGES**  
COMPARED TO A BRUSHED MOTOR

- +50% LIFETIME
- +50% AUTONOMY
- +50% POWER

MODE SELECTION:  
4 FUNCTIONS



NOT INCLUDED  
NIET INBEGREPEN  
NON INCLUS  
NICHT ENTHALTEN  
NO INCLUIDO  
NON INCLUSO

INCLUDED ACCESSORIES:

- 1x CHISEL - SDS PLUS TYPE - FLAT - 22x250mm
- 1x CHISEL - SDS PLUS TYPE - POINTED - 250mm
- 1x DRILL BIT - SDS PLUS TYPE - Ø 10x150mm
- 1x DRILL BIT - SDS PLUS TYPE - Ø 12x150mm
- 1x DRILL BIT - SDS PLUS TYPE - Ø 8x150mm



5 400338 094279

**POWDP20100**

## IMPACT SCREWDRIVER

SLAGSCHROEVENDRAAIER - TOURNEVIS À PERCUSSION - SCHLAG-SCHRAUBER  
ATORNILLADOR DE IMPACTO - AVVITATORE A PERCUSSIONE

**20 VOLT TOOL**

COMPATIBLE WITH



AND



RATED VOLTAGE  
**20V**

ROTATION SPEED

3 SETTINGS **0-1300min<sup>-1</sup>**  
**0-2000min<sup>-1</sup>**  
**0-2900min<sup>-1</sup>**

IMPACT RATE

**0-4350ipm**

MAX. TORQUE

**180Nm**



NOT INCLUDED  
NIET INBEGREPEN  
NON INCLUSO  
NICHT ENTHALTEN  
NO INCLUIDO  
NON INCLUSO



5 400338 092473

**POWDP20150**

## IMPACT WRENCH

SLAGMOERSLEUTEL - CLÉ A CHOC - SCHLAGSCHRAUBER  
LLAVE DE IMPACTO - CHIAVE AD IMPULSI

**20 VOLT TOOL**

COMPATIBLE WITH



AND



RATED VOLTAGE  
**20V**

ROTATION SPEED

3 SETTINGS **0-1300min<sup>-1</sup>**  
**0-2000min<sup>-1</sup>**  
**0-2900min<sup>-1</sup>**

IMPACT RATE

**0-4350ipm**

MAX. TORQUE

**220Nm**



NOT INCLUDED  
NIET INBEGREPEN  
NON INCLUSO  
NICHT ENTHALTEN  
NO INCLUIDO  
NON INCLUSO



5 400338 092480

**POWDP20160**

**IMPACT WRENCH** + 1 CHARGER  
+ 1 BATTERY 20V LI-ION

SLAGMOERSLEUTEL + LADER + 2x BATTERIJ 20V LI-ION  
CLÉ À CHOC + CHARGEUR + 2x BATTERIE 20V LI-ION  
SCHLAGSCHRAUBER + LADEGERÄT + 2x AKKU 20V LI-ION  
LLAVE DE IMPACTO + CARGADOR + 2x BATERÍA 20V LI-ION  
CHIAVE AD IMPULSI + CARICABATTERIE + 2x BATTERIA 20V LI-ION

**PROMO PACK**



COMPATIBLE WITH



AND



INCLUDED IN THIS PROMO PACK:

**POWDP20150:** IMPACT WRENCH

**POWDP9021:** BATTERY 20V= 2.0Ah

**POWDP9051:** CHARGER 4.0A

STORAGE CASE

5 400338 092497



**POWDP20400**

**IMPACT WRENCH**

SLAGMOERSLEUTEL - CLÉ À CHOC - SCHLAGSCHRAUBER  
LLAVE DE IMPACTO - CHIAVE AD IMPULSI



COMPATIBLE WITH



RATED VOLTAGE

**40V**

ROTATION SPEED

**0-2000min<sup>-1</sup>**

IMPACT RATE

**0-3300ipm**

MAX. TORQUE

**350Nm**



5 400338 092503



**POWDP25100**

## RECIPROCATING SAW

RECIPROZAAG - SCIE SABRE - SÄBELSÄGE  
SIERRA SABLE - SEGHETTO FRONTALE

**20 VOLT TOOL**

COMPATIBLE WITH



AND



RATED VOLTAGE  
**20V**

MAX. MOVEMENTS  
**0-2800min<sup>-1</sup>**

CUTTING DEPTH  
wood: **120mm**  
plastic: **50 mm**  
steel: **10mm**

RECIPROCATING LENGTH  
**28mm**



5 4003381092930



QUICK CHANGE LEVER



QUICK BLADE CHANGE

ADJUSTABLE PIVOT SHOE

SAW BLADE NOT INCLUDED



**POWDP25110**

## RECIPROCATING SAW + 1 CHARGER + 1 BATTERY 20V LI-ION

**PROMO PACK**

RECIPROZAAG + LADER + BATTERIJ 20V LI-ION  
SCIE SABRE + CHARGEUR + BATTERIE 20V LI-ION  
SÄBELSÄGE + LADEGERÄT + AKKU 20V LI-ION  
SIERRA SABLE + CARGADOR + BATERÍA 20V LI-ION  
SEGHETTO FRONTALE + CARICABATTERIE + BATTERIA 20V LI-ION

**20 VOLT TOOL**

COMPATIBLE WITH



AND



INCLUDED IN THIS PROMO PACK:

**POWDP25100: RECIPROCATING SAW**

**POWDP9021: BATTERY 20V 2.0Ah**

**POWDP9051: CHARGER 4.0A**

**STORAGE CASE**



5 4003381092954

**POWDP25200**

## CIRCULAR SAW

CIRKELZAAG - SCIE CIRCULAIRE - HANDKREISSÄGE  
SIERRA CIRCULAR - SEGA CIRCOLARE

**20  
VOLT  
TOOL**

COMPATIBLE  
WITH



AND



RATED VOLTAGE  
**20V**  $\equiv$

ROTATION SPEED  
**4000min<sup>-1</sup>**

BLADE SIZE  
**Ø165x20mm - 24T**

CUTTING CAPACITY  
**90°: 55mm / 45°: 38mm**



LED WORKLIGHT

**INCLUDED ACCESSORIES:**  
1x SAW BLADE - WOOD - 24T (MOUNTED)



5 400338 093364



**POWDP25230**

## CIRCULAR SAW

CIRKELZAAG - SCIE CIRCULAIRE - HANDKREISSÄGE  
SIERRA CIRCULAR - SEGA CIRCOLARE

**40  
VOLT  
TOOL**

COMPATIBLE  
WITH



RATED VOLTAGE  
**40V**  $\equiv$

ROTATION SPEED  
**4000min<sup>-1</sup>**

BLADE SIZE  
**Ø185x20mm - 24T**

CUTTING CAPACITY  
**90°: 62mm / 45°: 42mm**



LED WORKLIGHT

**INCLUDED ACCESSORIES:**  
1x SAW BLADE - WOOD - 24T (MOUNTED)



5 400338 094286



POWDP25260

## CIRCULAR SAW

CIRKELZAAG - SCIE CIRCULAIRE - HANDKREISSÄGE  
SIERRA CIRCULAR - SEGA CIRCOLARE

**40 VOLT TOOL**

COMPATIBLE WITH



RATED VOLTAGE  
**40V**

ROTATION SPEED  
**3800min<sup>-1</sup>**

BLADE SIZE  
**Ø190x20mm - 24T**

CUTTING CAPACITY  
**90°: 63mm / 45°: 41mm**

**BRUSHLESS MOTOR**



LED WORKLIGHT

**BRUSHLESS MOTOR**



**ADVANTAGES COMPARED TO A BRUSHED MOTOR**

- +50% LIFETIME
- +50% AUTONOMY
- +50% POWER

INCLUDED ACCESSORIES:  
1x SAW BLADE - WOOD - 24T (MOUNTED)



5 40033810942931

POWDP25400

## PLUNGE SAW

INVALZAAG - SCIE PLONGEANTE - TAUCHSÄGE  
SIERRA DE INCISIÓN - SEGA AD IMMERSIONE

**20 VOLT TOOL**

COMPATIBLE WITH



AND



RATED VOLTAGE  
**20V**

ROTATION SPEED  
**3150min<sup>-1</sup>**

BLADE SIZE  
**Ø89x10mm**

CUTTING CAPACITY  
**90°: wood 28mm  
aluminium 3mm  
tile 8mm**



GUIDE RAIL 3pcs x 410mm

INCLUDED ACCESSORIES:  
1x VACUUM ADAPTOR  
2x CLAMP  
3x GUIDE RAIL  
2x GUIDE RAIL CONNECTOR (STORED IN GUIDE RAIL)  
1x SAW BLADE - WOOD - 24T (MOUNTED)  
1x SAW BLADE - MULTI USE - 44T  
1x DIAMOND CUTTING DISC - WET - Ø 89mm



5 40033810958701

**POWDP25300**

**JIGSAW**

DECOUPEERZAAG - SCIE SAUTEUSE - STICHSÄGE  
SIERRA DE CALAR - SEGA DA TRAFORO



COMPATIBLE WITH



AND



RATED VOLTAGE  
**20V**  $\equiv$

ROTATION SPEED  
**0-2300**min<sup>-1</sup>

PENDULUM  
**4 POSITIONS**

CONNECTION TYPE  
**T&U-SHAPED**

CUTTING CAPACITY  
wood: 90mm / steel: 6mm / plastic: 6mm



QUICK BLADE CHANGE

INCLUDED ACCESSORIES:  
1x SAW BLADE - METAL  
1x SAW BLADE - WOOD



5 400338092541

5 400338092695

**POWDP25310**

**JIGSAW**

+ 1 CHARGER  
+ 1 BATTERY 20V LI-ION

DECOUPEERZAAG + LADER + BATTERIJ 20V LI-ION  
SCIE SAUTEUSE + CHARGEUR + BATTERIE 20V LI-ION  
STICHSÄGE + LADEGERÄT + AKKU 20V LI-ION  
SIERRA DE CALAR + CARGADOR + BATERÍA 20V LI-ION  
SEGA DA TRAFORO + CARICABATERIE + BATERIA 20V LI-ION

**PROMO PACK**



COMPATIBLE WITH



AND



INCLUDED IN THIS PROMO PACK:

**POWDP25300: JIGSAW**

**POWDP9021: BATTERY 20V  $\equiv$  2.0Ah**

**POWDP9051: CHARGER 4.0A**

**STORAGE CASE**

INCLUDED ACCESSORIES:  
1x SAW BLADE - METAL  
1x SAW BLADE - WOOD





**POWDP2550**

**MITRE SAW**

VERSTEKZAAG - SCIE À ONGLET - GEHRUNGSSÄGE  
INGLETADORA CORTE - TRONCATRICE

**20 VOLT TOOL**

COMPATIBLE WITH



AND



RATED VOLTAGE  
**20V**

ROTATION SPEED  
**3300min<sup>-1</sup>**

MAX. CUTTING CAPACITY  
**55x120mm**

SAW BLADE  
**Ø210x30x1.8mm - 40T**

INCLUDED ACCESSORIES:  
1x SAW BLADE - WOOD - 24T (MOUNTED)



NOT INCLUDED  
NIET INBEGREPEN  
NON INCLUS  
NICHT ENTHALTEN  
NO INCLUIDO  
NON INCLUSO

HINGED SAW  
BLADE GUARD

SAW BLADE  
FOR WOOD

DUST COLLECTION  
BAG

5 400338 092374



SCALE FOR ACCURATE  
HORIZONTAL ANGLE  
POSITIONING

ALUMINIUM  
BASE PLATE



VACUUM ADAPTOR



SCALE FOR ACCURATE VERTICAL ANGLE POSITIONING



ROTARY TABLE -45° / +45°



MAX. CUTTING CAPACITY

<p>max. 55x120mm</p> <p>90°</p> <p>90°</p>	<p>max. 55x83mm</p> <p>90°</p> <p>45°</p>	<p>max. 30x120mm</p> <p>45°</p> <p>90°</p>	<p>max. 30x83mm</p> <p>45°</p> <p>45°</p>
--	---	--	---

**POWDP2560**

**TELESCOPIC MITRE SAW**

TELESCOPISCHE VERSTEKZAAG - SCIE À ONGLET TÉLESCOPIQUE - TELESKOPISCHER GEHRUNGSSÄGE - INGLETADORA TELESCÓPICA - TRONCATRICE TELESCOPICA

**20 VOLT TOOL**

COMPATIBLE WITH



AND



RATED VOLTAGE  
**20V**

ROTATION SPEED  
**3300min<sup>-1</sup>**

MAX. CUTTING CAPACITY  
**60x220mm**

SAW BLADE  
**Ø210x30x2mm - 40T**



NOT INCLUDED  
NIET INBEGREPEN  
NON INCLUS  
NICHT ENTHALTEN  
NO INCLUIDO  
NON INCLUSO

HINGED SAW  
BLADE GUARD

ALUMINIUM  
BASE PLATE

HIGH PRECISION  
LASER

DUST COLLECTION  
BAG

SCALE FOR ACCURATE  
HORIZONTAL ANGLE  
POSITIONING

INCLUDED ACCESSORIES:  
1x SAW BLADE - WOOD - 24T (MOUNTED)



SCALE FOR ACCURATE VERTICAL ANGLE POSITIONING



HIGH PRECISION LASER



MAX. CUTTING CAPACITY

<p>90°</p> <p>max. 60x220mm</p> <p>90°</p>	<p>90°</p> <p>max. 60x150mm</p> <p>45°</p>	<p>45°</p> <p>max. 30x220mm</p> <p>90°</p>	<p>45°</p> <p>max. 30x150mm</p> <p>45°</p>
--	--	--	--

5 400338 092381



**POWDP2580**

## TABLE SAW

TAFELZAAG - SCIE À TABLE - TISCHKREISSÄGE  
SIERRA DE MESA - SIERRA DE MESA

**40  
VOLT  
TOOL**

COMPATIBLE WITH



RATED VOLTAGE  
**40V**

ROTATION SPEED  
**3800min<sup>-1</sup>**

MAX. CUTTING CAPACITY  
**90°: 70mm / 45°: 45mm**

SAW BLADE  
**Ø210x30x2mm - 40T**

MAIN TABLE SIZE  
**479x469mm**

INCLUDED ACCESSORIES:  
1x SAW BLADE - WOOD - 40T (MOUNTED)

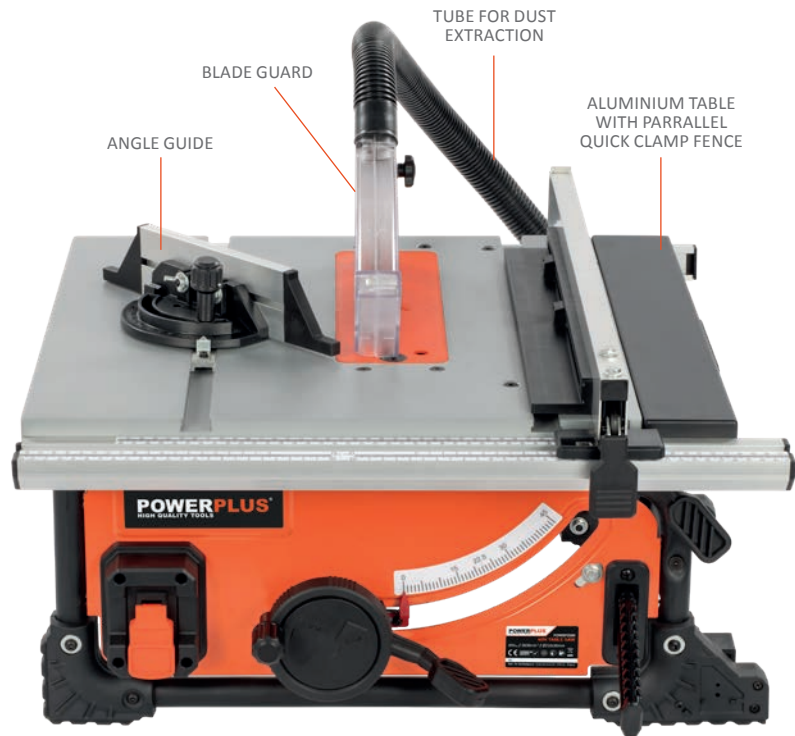

5 400338 093456



**POWDP75100**

## TILE CUTTER

TEGELSNIJDER - COUPE-CARRELAGE - FLIESENSCHNEIDMASCHINE  
CORTADOR DE AZULEJOS - TAGLIAPIASTRELLE

**20  
VOLT  
TOOL**

COMPATIBLE WITH



AND



RATED VOLTAGE  
**20V**

ROTATION SPEED  
**3800min<sup>-1</sup>**

DIAMOND CUTTING DISC  
**Ø110x22.2x1.5mm**

CUTTING CAPACITY  
**90°: 24mm  
45°: 16mm**

ON/OFF SWITCH



5 400338 092251



WATER RESERVOIR PLUG

INCLUDED ACCESSORIES:  
1x DIAMOND CUTTING DISC - WET - Ø 110mm



**POWDP35100**

## ANGLE GRINDER

HAAKSE SLIJPER - MEULEUSE D'ANGLE - WINKELSCHLEIFER  
AMOLADORA ANGULAR - SMERIGLIATRICE ANGOLARE

**20  
VOLT  
TOOL**

COMPATIBLE  
WITH



AND



RATED VOLTAGE  
**20V**  $\equiv$

ROTATION SPEED  
**8500min<sup>-1</sup>**

DISC DIAMETER  
**Ø115mm**

SOFT START



QUICK CLAMP SYSTEM  
FOR GUARD



SPANNER (STORED IN HANDLE)



5 400338 092718

**POWDP35150**

## ANGLE GRINDER + 1 CHARGER + 1 BATTERY 2x20V LI-ION

HAAKSE SLIJPER + LADER + BATTERIJ 2x20V LI-ION  
MEULEUSE D'ANGLE + CHARGEUR + BATTERIE 2x20V LI-ION  
WINKELSCHLEIFER + LADEGERÄT + AKKU 2x20V LI-ION  
AMOLADORA ANGULAR + CARGADOR + BATERÍA 2x20V LI-ION  
SMERIGLIATRICE ANGOLARE + CARICABATTERIE + BATTERIA 2x20V LI-ION

## PROMO PACK

**20  
VOLT  
TOOL**

COMPATIBLE  
WITH



AND



INCLUDED IN THIS PROMO PACK:

**POWDP35100:** ANGLE GRINDER

**POWDP9037:** BATTERY 2x20V  $\equiv$   
5.0Ah on a 20V tool  
2.5Ah on a 40V tool

**POWDP9051:** CHARGER 4.0A

STORAGE CASE



**+ 2x20V  
BATTERY  
FOR BETTER  
PERFORMANCE**

5 400338 092725

POWDP35170

## ANGLE GRINDER

HAAKSE SLIJPER - MEULEUSE D'ANGLE - WINKELSCHLEIFER  
AMOLADORA ANGULAR - SMERIGLIATRICE ANGOLARE

**40 VOLT**  
TOOL

COMPATIBLE WITH



RATED VOLTAGE  
**40V**

ROTATION SPEED  
**10.000min<sup>-1</sup>**

DISC DIAMETER  
**Ø125mm**

SOFT START  
**BRUSHLESS MOTOR**



QUICK CLAMP SYSTEM FOR GUARD



SPANNER (STORED IN HANDLE)

**BRUSHLESS**  
MOTOR



ADVANTAGES  
COMPARED TO A BRUSHED MOTOR

**+50% LIFETIME**  
**+50% AUTONOMY**  
**+50% POWER**



5 400338 092732



POWDP4050

## PLANER

SCHAAFMACHINE - RABOT ÉLECTRIQUE  
AKKU-HOBEL - CEPILLO PORTÁTIL - PIALLA

**20 VOLT**  
TOOL

COMPATIBLE WITH



AND



RATED VOLTAGE  
**20V**

ROTATION SPEED  
**14.000min<sup>-1</sup>**

PLANING WIDTH x DEPTH  
**82x2mm**

MAX. REBATE DEPTH  
**8mm**

**BRUSHLESS MOTOR**

**BRUSHLESS**  
MOTOR



ADVANTAGES  
COMPARED TO A BRUSHED MOTOR

**+50% LIFETIME**  
**+50% AUTONOMY**  
**+50% POWER**



STORAGE FOR SPANNER AND KEY



V-GROOVES AND KNIVES



5 400338 093746



INCLUDED ACCESSORIES:  
2x KNIFE (MOUNTED)

**POWDP4060**

## OSCILLATING MULTITOOL

OSCILLERENDE MULTITOOL - MULTI-OUTIL OSCILLANT - OSZILLIERENDES MULTITOOL  
MULTIHERRAMIENTA OSCILANTE - UTENSILE MULTIFUNZIONE

**20 VOLT TOOL**

COMPATIBLE WITH



AND

RATED VOLTAGE  
**20V**

MOVEMENTS  
**10.000-40.000min<sup>-1</sup>**

SPEED POSITIONS  
**6**



NOT INCLUDED  
NIET INBEGREPEN  
NON INCLUS  
NICHT ENTHALTEN  
NO INCLUIDO  
NON INCLUSO



INCLUDED ACCESSORIES:

- 1x SANDING PAD
- 1x SAW BLADE
- 1x SCRAPER BLADE
- 1x SHEET OF SANDPAPER - TRIANGULAR - WOOD - G60
- 1x SHEET OF SANDPAPER - TRIANGULAR - WOOD - G80

VARIABLE SPEED DIAL

HOOK & LOOP SYSTEM

VACUUM ADAPTOR SET

5 400338 079535



**POWDP75300**

## ROTARY MULTITOOL

**NEW**

ROTIERENDE MULTITOOL - MULTI-OUTIL ROTATIF - ROTIERENDES MULTITOOL  
MULTIHERRAMIENTA ROTATIVA - MULTITOOL ROTATIVO

**20 VOLT TOOL**

COMPATIBLE WITH



AND

RATED VOLTAGE  
**20V**

ROTATION SPEED  
**5000-33000min<sup>-1</sup>**

DIAMETER COLLET  
**Max. 3.2mm**

INCLUDED ACCESSORIES:

- 4x CARVING BIT
- 1x COMBINATION TOOL
- 5x CUTTING DISC
- 1x DRILL BIT
- 1x FLEXIBLE SHAFT
- 3x GRINDING STONE
- 1x HAND PIECE HOLDER
- 1x MANDREL FOR CUTTING DISC
- 1x MANDREL FOR POLISHING FELT
- 2x MANDREL FOR SANDING SLEEVE
- 1x POLISHING COMPOUND
- 4x POLISHING FELT
- 10x SANDING DISC
- 6x SANDING SLEEVE
- 1x WIRE BRUSH STEEL



NOT INCLUDED  
NIET INBEGREPEN  
NON INCLUS  
NICHT ENTHALTEN  
NO INCLUIDO  
NON INCLUSO



**COMPACT X-TREME POWER**

INCL. 40 ACCESSORIES

ERGONOMIC HANDLE WITH SOFT GRIP

FLEXIBLE SHAFT 1m

ELECTRIC SPEED CONTROL

5 400338 098321



**POWDP4070**

## ANGLE POLISHER

HAAKSE POLIERMACHINE - POLLISEUSE D'ANGLE  
WINKELPOLIERMASCHINE - PULIDOR DE ÁNGULOS - LUCIDATRICE ANGOLARE

**20 VOLT TOOL**

COMPATIBLE WITH



AND



RATED VOLTAGE

20V

ROTATION SPEED

500-3000min<sup>-1</sup>

SPEED POSITIONS

6

SANDING SURFACE DIAMETER

Ø180mm

**BRUSHLESS MOTOR**



ON/OFF SWITCH



NOT INCLUDED  
NIET INBEGREPEN  
NON INCLUS  
NICHT ENTHALTEN  
NO INCLUIDO  
NON INCLUSO

**BRUSHLESS MOTOR**



**ADVANTAGES COMPARED TO A BRUSHED MOTOR**

**+50% LIFETIME  
+50% AUTONOMY  
+50% POWER**



- INCLUDED ACCESSORIES:**  
1x POLISHING SPONGE  
1x POLISHING - SANDING PAD  
1x POLISHING BONNET - EXTRA FINE  
1x SHEET OF SANDPAPER - ROUND - WOOD - G60  
2x SHEET OF SANDPAPER - ROUND - WOOD - G120  
2x SHEET OF SANDPAPER - ROUND - WOOD - G240



5 4003381093852

**POWDP4040**

## POLISHER

POLIERMACHINE - POLISSEUSE - POLIERMASCHINE  
PULIDORA DE GAMUZA - LUCIDATRICE

**20 VOLT TOOL**

COMPATIBLE WITH



AND



RATED VOLTAGE

20V

ROTATION SPEED

1500-3000min<sup>-1</sup>

POLISHING SURFACE

Ø240mm

- INCLUDED ACCESSORIES:**  
1x POLISHING BONNET - EXTRA FINE  
1x POLISHING BONNET - FINE



POLISHING BONNET

ON/OFF SWITCH



SPEED SELECTOR



NOT INCLUDED  
NIET INBEGREPEN  
NON INCLUS  
NICHT ENTHALTEN  
NO INCLUIDO  
NON INCLUSO



5 4003381080654

**POWDP50200**

## PALM SANDER

HANDPALMSCHUURMACHINE - PONCEUSE À MAIN - HANDSCHLEIFER  
LIJADORA DE MANO - AVVITATORE A PERCUSSIONE

**20 VOLT TOOL**

COMPATIBLE WITH



AND



RATED VOLTAGE  
**20V**

MOVEMENTS  
**24.000min<sup>-1</sup>**

SANDING SURFACE  
**140x140x80mm**



HOOK AND LOOP SYSTEM

INCLUDED ACCESSORIES:  
1x SHEET OF SANDPAPER - IRON SHAPED - WOOD - G80



**POWDP50300**

## FINISHING SANDER

VLAKSCHUURMACHINE - PONCEUSE VIBRANTE - SCHWINGSCHLEIFER  
LIJADORA ORBITAL - LEVIGATRICE PER FINITURA

**20 VOLT TOOL**

COMPATIBLE WITH



AND



RATED VOLTAGE  
**20V**

MOVEMENTS  
**24.000min<sup>-1</sup>**

SANDING SURFACE  
**187x90mm**



HOOK AND LOOP SYSTEM

HOOK AND LOOP SYSTEM  
+ QUICK CLAMP SYSTEM

INCLUDED ACCESSORIES:  
1x SHEET OF SANDPAPER - RECTANGULAR - WOOD - G80





**POWDP50400**

## ECCENTRIC SANDER

EXCENTRISCHE SCHUURMACHINE - PONCEUSE EXCENTRIQUE - EXZENTERSCHLEIFER - LIJADORA EXCÉNTRICA - LEVIGATRICE ECCENTRICA

**20 VOLT TOOL**

COMPATIBLE WITH



AND



RATED VOLTAGE  
**20V**

MOVEMENTS  
**24000min<sup>-1</sup>**

SANDING SURFACE  
**Ø125mm**

SOFT GRIP

ON/OFF SWITCH FOR LEFT AND RIGHT HANDED USE

DUST COLLECTION BAG

HOOK AND LOOP SYSTEM



HOOK AND LOOP SYSTEM

INCLUDED ACCESSORIES:  
1x SHEET OF SANDPAPER - ROUND - WOOD - G80



**POWDP50700**

## FILE/BELT SANDER

VIJL/BANDSCHUURMACHINE - LIME/PONCEUSE À BANDE - FEILE/BANDSCHLEIFER - LIMA/LIJADORA DE BANDA - LEVIGATRICE A NASTRO

**20 VOLT TOOL**

COMPATIBLE WITH



AND



RATED VOLTAGE  
**20V**

BELT SPEED  
**360-800m/min**

SANDING BELT  
**13x457mm**

SPEED ADJUSTMENT DIAL

LOCK-ON BUTTON

MANUAL BELT CONTROL SYSTEM

SOFT GRIP

INCLUDED ACCESSORIES:  
1x SANDING BELT G80



ADJUSTABLE BELT KNOB



LOCK-ON BUTTON



**POWDP6020**

## ASH CLEANER

ASZUIGER - VIDE CENDRES - ASCHESAUGER  
ASPIRADOR DE CENIZAS - ASPIRACENERE

**20 VOLT TOOL**

COMPATIBLE WITH



AND



RATED VOLTAGE

20V  $\equiv$

TANK CAPACITY

20L

TANK SIZE

Ø295mm - H310mm

HOSE LENGTH

1m x Ø36.5mm

NOZZLE DIAMETER

Ø34mm

MAX. TEMPERATURE ASHES

40°C



REPLACEABLE HIGH EFFICIENCY FILTER



NOT INCLUDED  
NIET INBEGREPEN  
NON INCLUS  
NICHT ENTHALTEN  
NO INCLUIDO  
NON INCLUSO

INCLUDED ACCESSORIES:

1x HIGH EFFICIENCY FILTER (MOUNTED)



ON-OFF SWITCH

STRONG AND DURABLE STEEL TANK

PLASTIC COATED METAL SUCTION HOSE

ALUMINIUM SUCTION NOZZLE  
Ø34mm x 230mm

5 4003381081248



**POWDP6020A**

## SPARE FILTER

FILTER - FILTRE - FILTER  
FILTRO - FILTRO

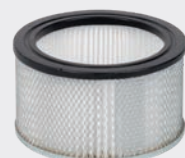

**POWDP6030**

# HANDHELD VACUUM CLEANER

KRUIMELDIEF - ASPIRATEUR À MAIN - HANDSTAUBSAUGER  
ASPIRADOR DE MANO - ASPIRAPOLVERE PORTATILE

**20 VOLT TOOL**

COMPATIBLE WITH



AND



RATED VOLTAGE

**20V**

CONTAINER VOLUME

**600ml**

SUCTION POWER

**8 kPa**

MAX. FLOW RATE

**0.7m<sup>3</sup>/min**

AIR POWER

**93W**

WORKING CURRENT

**6.3A**



DETACHABLE



FILTER



1x TUBE

1x CREVICE NOZZLE

1x BRUSH NOZZLE

5 400338 094491



NOT INCLUDED  
NIET INBEGREPEN  
NON INCLUS  
NICHT ENTHALTEN  
NO INCLUIDO  
NON INCLUSO

**POWDP6040**

**VACUUM CLEANER WET/DRY**

STOFZUIGER NAT/DROOG - ASPIRATEUR HUMIDE/SEC - STAUBSAUGER NASS/TROCKEN  
ASPIRADOR SECO/HÚMEDO - ASPIRAPOLVERE BAGNATO/ASCIUTTO

**20  
VOLT  
TOOL**

COMPATIBLE  
WITH



AND



RATED VOLTAGE  
**20V**

TANK CAPACITY  
**20L**

TANK SIZE  
**Ø295mm - H285mm**

FLEXIBLE HOSE  
**1.5m x Ø32mm**

NOZZLE DIAMETER  
**Ø30mm**

SUCTION POWER  
**10 kPa**



INCLUDED ACCESSORIES:  
1x HIGH EFFICIENCY FILTER  
(MOUNTED)

FLOOR NOZZLE

3pcs PLASTIC TUBE  
(Ø32x400mm)

2-IN-1  
CREVICE  
NOZZLE



REPLACEABLE HIGH EFFICIENCY FILTER

5 400338 081750



NOT INCLUDED  
NIET INBEGREPEN  
NON INCLUS  
NICHT ENTHALTEN  
NO INCLUIDO  
NON INCLUSO

**POWDP6050**

**VACUUM CLEANER WET/DRY**

STOFZUIGER NAT/DROOG - ASPIRATEUR HUMIDE/SEC - STAUBSAUGER NASS/TROCKEN  
ASPIRADOR SECO/HÚMEDO - ASPIRAPOLVERE BAGNATO/ASCIUTTO

**20 VOLT TOOL**

COMPATIBLE WITH



AND



RATED VOLTAGE  
**20V**

TANK CAPACITY  
**30L**

TANK SIZE  
**Ø295mm - H425mm**

FLEXIBLE HOSE  
**3m x Ø32mm**

NOZZLE DIAMETER  
**Ø30mm**

SUCTION POWER  
**13 kPa**

**BRUSHLESS MOTOR**



**ADVANTAGES**  
COMPARED TO A BRUSHED MOTOR

- +50% LIFETIME
- +50% AUTONOMY
- +50% POWER



REPLACEABLE HIGH EFFICIENCY FILTER



INCLUDED ACCESSORIES:  
1x HIGH EFFICIENCY FILTER  
(MOUNTED)



2-IN-1 CREVICE NOZZLE



NOT INCLUDED  
NIET INBEGREPEN  
NON INCLUS  
NICHT ENTHALTEN  
NO INCLUIDO  
NON INCLUSO

5 400338 1081767

**POWDP60810**

**COFFEE MACHINE**

KOFFIEZETAPPARAAT - MACHINE À CAFÉ - KAFFEEMASCHINE  
MÁQUINA DE CAFÉ - MACCHINA DA CAFFÈ

**40  
VOLT  
TOOL**

COMPATIBLE  
WITH



RATED VOLTAGE  
**40V**

COFFEE PAD  
**Ø60mm**

COFFEE CUP  
**STAINLESS STEEL**

USE WITH  
**GROUND COFFEE OR PADS**

WATER TANK  
**240ml**

BREW TIME  
**6min.**

CARRYING  
HANDLE

5 4003381093791



STAINLESS STEEL  
COFFEE CUP  
200ml

240ml DETACHABLE  
WATER TANK

**NO PAPER FILTER REQUIRED**

**PADS OR GROUND COFFEE**



GROUND COFFEE BASKET  
(NO PAPER FILTER REQUIRED)



60mm  
COFFEE PAD  
(COMPATIBLE WITH MOST  
COMMON PADS)



NOT INCLUDED  
NIET INBEGREPEN  
NON INCLUS  
NICHT ENTHALTEN  
NO INCLUIDO  
NON INCLUSO

**POWDP7010**

**STAPLER/NAILER**

NIET-/NAGELAPPARAAT - AGRAFEUSE - CLOUEUSE - TACKER - NAGLER  
GRAPADORA - CLAVADORA - CUCITRICE - CHIODATRICE

**20 VOLT TOOL**

COMPATIBLE WITH



AND



RATED VOLTAGE  
**20V**

FIRING CAPACITY  
**30/min.**

MAGAZINE CAPACITY  
**50pcs**

MINIMUM LENGTH NAILS/STAPLES  
**15mm**

MAXIMUM LENGTH NAILS/STAPLES  
**32mm/25mm**

MAXIMUM WIDTH STAPLES  
**6mm**

INCLUDED ACCESSORIES:  
100 STAPLES 19mm  
100 NAILS 19mm



NOT INCLUDED  
NIET INBEGREPEN  
NON INCLUS  
NICHT ENTHALTEN  
NO INCLUIDO  
NON INCLUSO

DEPTH ADJUSTMENT WHEEL

LED WORKLIGHT

SAFETY CONTACT NOSE



COOLING VENTS

MAGAZINE LEVEL INDICATOR

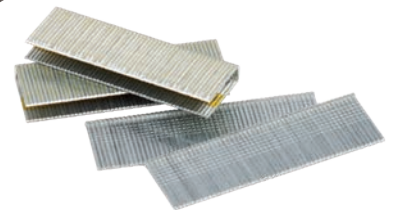

5 4003381095986

5 4003381079573

**POWDP7020**

**AIR PUMP**

LUCHTPOMP - POMPE À AIR - LUFTPUMPE  
BOMBA DE AIRE - POMPA PNEUMATICA

**20 VOLT TOOL**

COMPATIBLE WITH



AND



RATED VOLTAGE  
**20V**

MAX. PRESSURE  
**8bar**

AIR DEBIT (CAPACITY)  
**30l/min**

INCLUDED ACCESSORIES:  
1x VALVE ADAPTOR  
1x AIRBED ADAPTOR  
1x BALL NEEDLE



DIGITAL PRESSURE GAUGE WITH  
PRE SETTING AND AUTO STOP

VALVE ADAPTOR

AIRBED ADAPTOR

BALL NEEDLE



FLEXIBLE HOSE

LED WORKLIGHT

STORAGE FOR INFLATION ADAPTORS



NOT INCLUDED  
NIET INBEGREPEN  
NON INCLUS  
NICHT ENTHALTEN  
NO INCLUIDO  
NON INCLUSO

**POWDP7050**

## CAULKING GUN

KITPISTOOL - PISTOLET D'ÉTANCHÉITÉ - DICHTSTOFFPISTOLE  
PISTOLA SILICONA - PISTOLA PER SILICONE

**20  
VOLT  
TOOL**

COMPATIBLE  
WITH



AND



RATED VOLTAGE  
**20V**

ADJUSTABLE SPEED  
**0.5-7mm/sec**

CAPACITY HOLDER  
**Max. 310ml**



NOT INCLUDED  
NIET INBEGREPEN  
NON INCLUS  
NICHT ENTHALTEN  
NO INCLUIDO  
NON INCLUSO

5 400338 079603

**POWDP7080**

## CONCRETE/PAINT MIXER

BETON-/ VERFMENGER - MÉLANGEUR À BÉTON/PEINTURE  
RÜHRWERK - MEZCLADOR ELÉCTRICO - AGITATORE

**20  
VOLT  
TOOL**

COMPATIBLE  
WITH



AND



RATED VOLTAGE  
**20V**

ROTATION SPEED  
**0-650min<sup>-1</sup>**

MAX. TORQUE  
**5.5Nm**

DIMENSIONS MIXING PADDLE  
**Ø100x590mm**

INCLUDED ACCESSORIES:  
1X MIXING PADDLE



SPEED CONTROL



NOT INCLUDED  
NIET INBEGREPEN  
NON INCLUS  
NICHT ENTHALTEN  
NO INCLUIDO  
NON INCLUSO



5 400338 079542



**POWDP7060**

# SOLDERING IRON

SOLDEERBOUT - FER À SOUDER - LÖTKOLBEN  
SOLDADOR - SALDATORE

**20 VOLT TOOL**

COMPATIBLE WITH



AND



RATED VOLTAGE  
**20V**

TEMPERATURE  
**200-480°C**

HEAT UP TIME  
**200°C : 10sec / 480°C : 35sec**



NOT INCLUDED  
NIET INBEGREPEN  
NON INCLUS  
NICHT ENTHALTEN  
NO INCLUIDO  
NON INCLUSO



POWDP7030

## INFLATOR/DEFLATOR

INFLATOR/DEFLATOR - GONFLEUR/DÉGONFLEUR - LUFTPUMPE  
INFLADOR/DESINFLADOR - GONFIATORE/SGONFIATORE

USE WITH

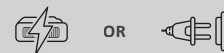

**20 VOLT**  
TOOL

**220 VOLT~**  
TOOL

**20 VOLT**  
TOOL

COMPATIBLE WITH



AND



RATED VOLTAGE

20V ~ / 220V ~ 50Hz

MAX. PRESSURE

11bar

AIR DEBIT (CAPACITY)

high pressure | low volume

30l/min

AIR DEBIT (CAPACITY)

low pressure | high volume

360l/min

AIR DEBIT (CAPACITY)

deflating

360l/min

HIGH PRESSURE /  
HIGH VOLUME  
SWITCH

DIGITAL PRESSURE GAUGE  
WITH PRE SETTINGS AND  
AUTO STOP

AC/DC  
POWER SWITCH



AIR HOSE  
+ NOZZLE

STORAGE FOR  
INFLATION ADAPTORS

5 4003381079689



USE WITH POWER CABLE  
OR BATTERY



USB-3 CONNECTION



INCLUDED ACCESSORIES:  
1x VALVE ADAPTOR  
1x AIRBED ADAPTOR  
1x BALL NEEDLE



CABLE STORAGE



NOT INCLUDED  
NIET INBEGREPEN  
NON INCLUS  
NICHT ENTHALTEN  
NO INCLUIDO  
NON INCLUSO

**POWDP7070**  
**COMPRESSOR**

COMPRESSOR - COMPRESSEUR - KOMPRESSOR  
COMPRESOR - COMPRESSORE

**40**  
**VOLT**  
**TOOL**

COMPATIBLE WITH



**2 BATTERY SLOTS**  
**= EXTRA LONG**  
**WORKING TIME**



5 4003381087226

RATED VOLTAGE  
**40V**

MAX. PRESSURE  
**8bar**

AIR DEBIT (CAPACITY)  
**36l/min**

TANK CAPACITY  
**5L**

ROTATION SPEED  
**3000min<sup>-1</sup>**

TANK PRESSURE METER

PRESSURE REGULATOR

OUTLET PRESSURE METER

CONDENSATION OUTLET



**POWERPLUS**  
HIGH QUALITY TOOLS



SAFETY VALVE



EURO QUICK COUPLER



NOT INCLUDED  
NIET INBEGREPEN  
NON INCLUS  
NICHT ENTHALTEN  
NO INCLUIDO  
NON INCLUSO

**POWDP77100**

## BISCUIT JOINER

LAMELLENFREES - FRAISEUSE À LAMELLES - FLACHDÜBELFRÄSE  
ENGALLETADORA - TAGLIABISCOTTI

**40 VOLT TOOL**

COMPATIBLE WITH



RATED VOLTAGE  
**40V**

ROTATION SPEED  
**6500min<sup>-1</sup>**

BLADE SIZE  
**Ø100x22x3.8mm - 6T**

CUTTING DEPTH  
**8-10-12.3-13-14.7-20mm**

CUTTING HEIGHT  
**0-40mm**

ADJUSTABLE ANGLE  
**0° - 90°**

INCLUDED ACCESSORIES:  
1x SAW BLADE - WOOD - 6T (MOUNTED)



NOT INCLUDED  
NIET INBEGREPEN  
NON INCLUS  
NICHT ENTHALTEN  
NO INCLUIDO  
NON INCLUSO



DUST COLLECTION BAG

5 400338 095894



**POWDP8015**

## CORDLESS FAN

DRAADLOZE VENTILATOR - VENTILATEUR SANS FIL - AKKU-LÜFTER  
VENTILADOR INALÁMBRICO - VENTOLA CORDLESS

**20 VOLT TOOL**

COMPATIBLE WITH



AND



RATED VOLTAGE  
**20V**

ROTATION SPEED  
**1700min<sup>-1</sup>**  
**2600min<sup>-1</sup>**

AIR VOLUME  
**18.5m<sup>3</sup>/min**

PROPELLER DIAMETER  
**Ø230mm**



NOT INCLUDED  
NIET INBEGREPEN  
NON INCLUS  
NICHT ENTHALTEN  
NO INCLUIDO  
NON INCLUSO



ON/OFF SWITCH +  
SPEED SELECTOR ( 2 SETTINGS)

5 400338 083235



**POWDP8031**

# PORTABLE FLOODLIGHT

DRAAGBARE SCHIJNWERPER - PROJECTEUR PORTATIF - TRAGBARES FLUTLICHT -  
PROYECTOR PORTÁTIL - PROIETTORE PORTATILE

**20 VOLT**  
TOOL

COMPATIBLE WITH



AND



RATED VOLTAGE  
**20V**

LIFESPAN BULB  
**50.000h**

LUMEN  
I: **1100lm**  
II: **2000lm**  
III: **2700lm**

COLOUR TEMPERATURE  
**6400K**



NOT INCLUDED  
NIET INBEGREPEN  
NON INCLUS  
NICHT ENTHALTEN  
NO INCLUIDO  
NON INCLUSO



360° TILTABLE  
UPWARDS &  
DOWNWARDS

HANGING  
HOOK

STAND

5 1400338 092183



ON/OFF SWITCH +  
MODE SELECTOR

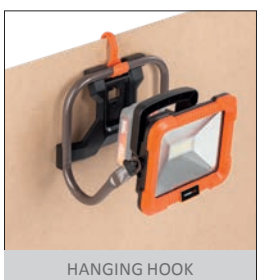

HANGING HOOK



**POWDP8035**

**PORTABLE FLOODLIGHT WITH TRIPOD**

DRAAGBARE SCHIJNWERPER MET STATIEF - PROJECTEUR PORTATIF AVEC TRÉPIED - TRAGBARES FLUTLICHT MIT STATIV - PROYECTOR PORTÁTIL CON TRIPODE - PROIETTORE PORTATILE CON TREPIEDE

USE WITH

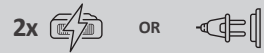

1 BATTERY  
NEEDED FOR  
EACH LIGHT



COMPATIBLE WITH



AND



RATED VOLTAGE  
**20V** ~

LIFESPAN BULB  
**20.000h**

LUMEN  
**2x 2000lm**

COLOUR TEMPERATURE  
**5000K**



NOT INCLUDED  
NIET INBEGREPEN  
NON INCLUS  
NICHT ENTHALTEN  
NO INCLUIDO  
NON INCLUSO



INDIVIDUAL VARIABLE DIMMING



5 1400338 095061



**DUAL  
POWER**  
choose your battery

**GARDEN TOOLS**

**POWDPG7521**

## LEAF BLOWER

BLADBLAZER - SOUFFLEUR DE FEUILLES - LAUBBLÄSER  
SOPLADOR DE HOJAS - SOFFIATORE DI FOGLIE

**20  
VOLT  
TOOL**

COMPATIBLE  
WITH

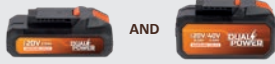

AND

RATED VOLTAGE  
**20V**

MAX. AIR SPEED  
LOW SPEED: 115km/h  
TURBO MODE: 145km/h

MAX. AIR VOLUME  
**9.5m<sup>3</sup>/min**



5 400338 091964

5 400338 083440

**POWDPG7526**

## LEAF BLOWER

BLADBLAZER - SOUFFLEUR DE FEUILLES - LAUBBLÄSER  
SOPLADOR DE HOJAS - SOFFIATORE DI FOGLIE

**40  
VOLT  
TOOL**

COMPATIBLE  
WITH



RATED VOLTAGE  
**40V**

MAX. AIR SPEED  
100-112-133-151km/h  
TURBO MODE: 200km/h

MAX. AIR VOLUME  
**13.8m<sup>3</sup>/min**

**BRUSHLESS MOTOR**



1. ON/OFF BUTTON
2. TURBO BUTTON
3. REDUCE SPEED
4. INCREASE SPEED
5. SPEED INDICATOR
6. BATTERY INDICATOR



**ADVANTAGES  
COMPARED TO A BRUSHED MOTOR**

- +50% LIFETIME**
- +50% AUTONOMY**
- +50% POWER**



**POWDPG75270**

# LEAF BLOWER/VACUUM

BLADBLAZER/-ZUIGER - ASPIRATEUR/SOUFFLEUR DE FEUILLES - LAUBSAUGER/-BLÄSER  
ASPIRADOR/SOPLADOR DE HOJAS - ASPIRATORE/SOFFIATORE

**40 VOLT TOOL**

COMPATIBLE WITH



RATED VOLTAGE  
**40V**

MAX. AIR SPEED  
**210km/h**

MAX. AIR VOLUME  
**9.5m³/min**

COLLECTION BAG  
**45L**

SHREDDING RATIO  
**15:1**

**BRUSHLESS MOTOR**

3 FUNCTIONS  
Blowing  
Vacuuming  
Shredding

**BRUSHLESS MOTOR**



**ADVANTAGES COMPARED TO A BRUSHED MOTOR**

- +50% LIFETIME**
- +50% AUTONOMY**
- +50% POWER**



5 4003381094277



NOT INCLUDED  
NIET INBEGREPEN  
NON INCLUS  
NICHT ENTHALTEN  
NO INCLUIDO  
NON INCLUSO



CLEANING WINDOW



SELECTION SWITCH FOR VACUUM + SHREDDING/ BLOWING FUNCTION

**POWDPG7531**

## HEDGE TRIMMER

HAAGSCHAAR - TAILLE-HAIE - HECKENSCHERE  
CORTASETOS - TAGLIASIEPI

**20  
VOLT  
TOOL**

COMPATIBLE  
WITH



AND



RATED VOLTAGE  
**20V**  $\equiv$

ROTATION SPEED  
**1200min<sup>-1</sup>**

BLADE LENGTH  
**580mm**

MAX. CUTTING LENGTH  
**510mm**

KNIFE DISTANCE  
**18mm**

DOUBLE ACTION /  
LASER CUT BLADE

PROTECTIVE NOSE WITH  
HANGING HOLE



NOT INCLUDED  
NIET INBEGREPEN  
NON INCLUS  
NICHT ENTHALTEN  
NO INCLUIDO  
NON INCLUSO



5 400338 083310

5 400338 090981

**POWDPG75320**

## HEDGE TRIMMER + 1 CHARGER + 1 BATTERY 20V LI-ION

HAAGSCHAAR + LADER + BATTERIJ 20V LI-ION  
TAILLE-HAIE + CHARGEUR + BATTERIE 20V LI-ION  
HECKENSCHERE + LADEGERÄT + AKKU 20V LI-ION  
CORTASETOS + CARGADOR + BATERÍA 20V LI-ION  
TAGLIASIEPI + CARICABATTERIE + BATTERIA 20V LI-ION

**20  
VOLT  
TOOL**

COMPATIBLE  
WITH



AND



INCLUDED IN THIS PROMO PACK:

**POWDPG7531:** HEDGE TRIMMER

**POWDP9021:** BATTERY 20V  $\equiv$  2.0Ah

**POWDP9051:** CHARGER 4.0A

DOUBLE ACTION /  
LASER CUT BLADE



## PROMO PACK

**POWDPG7536**

# HEDGE TRIMMER

HAAGSCHAAR - TAILLE-HAIE - HECKENSCHERE  
CORTASETOS - TAGLIASIEPI

**40 VOLT TOOL**

COMPATIBLE WITH



RATED VOLTAGE  
**40V**

ROTATION SPEED  
**1200min<sup>-1</sup>**

BLADE LENGTH  
**670mm**

MAX. CUTTING LENGTH  
**600mm**

KNIFE DISTANCE  
**22mm**



POWDPG75300

**TELESCOPIC GRASS/SHRUB SHEARS**

**NEW**

TELESCOPISCHE GRAS-/HAAGSCHAAR - CISAILLE À GAZON/SCULPTE-HAIES TÉLESCOPIQUE - TELESKOPISCHE RASEN-/STRAUCHSCHERE - CORTABORDES/RECORTASETOS TELESCÓPICO - FORBICI PER ERBA/ARBUSTI TELESCOPICI

**20 VOLT TOOL**

COMPATIBLE WITH



AND



RATED VOLTAGE  
20V

CUTTING WIDTH  
grass shears: 100mm

CUTTING LENGTH  
hedge shears: 185mm

TELESCOPIC SHAFT  
63cm → 92cm

**4 OPTIONS**



ADJUSTABLE AUXILIARY HANDLE (5 POSITIONS)



ALUMINIUM TELESCOPIC SHAFT 63cm TO 92cm



ADJUSTABLE HEAD

GUIDE WHEELS

LASER CUT/  
DOUBLE ACTION BLADE

2x BLADE GUARD

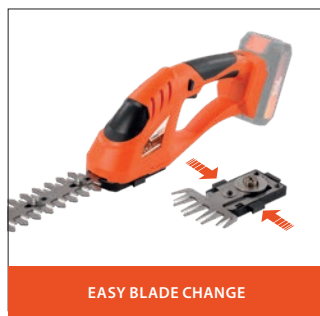

EASY BLADE CHANGE



5 400338 099884



**POWDPG75380**

## TELESCOPIC HEDGE TRIMMER

TELESCOPISCHE HAAGSCHAAR - TAILLE-HAIE TÉLESCOPIQUE - TELESKOP-HECKENSCHERE  
CORTASETOS TELESCÓPICA - TAGLIASIEPI TELESCOPICO

**40 VOLT TOOL**

COMPATIBLE WITH



RATED VOLTAGE  
**40V**

ROTATION SPEED  
**1400min<sup>-1</sup>**

BLADE LENGTH  
**600mm**

MAX. CUTTING LENGTH  
**510mm**

KNIFE DISTANCE  
**20mm**

TELESCOPIC SHAFT  
**87cm → 155cm**

TOTAL LENGTH  
**210cm → 280cm**



NOT INCLUDED  
NIET INBEGREPEN  
NON INCLUS  
NICHT ENTHALTEN  
NO INCLUIDO  
NON INCLUSO



SHOULDER STRAP



BLADE GUARD



ADJUSTABLE HEAD  
ROTATES IN  
2 DIRECTIONS

ALUMINIUM TELESCOPIC  
SHAFT 87cm TO 155cm

SOFT GRIP

LASER CUT/  
DOUBLE ACTION BLADE

PROTECTIVE NOSE

5 400338 093371



**POWDPG7541**

**GRASS TRIMMER**

GRASTRIMMER - COUPE-BORDURE - RASENTRIMMER  
CORTABORDES - TAGLIAERBA

**20 VOLT TOOL**

COMPATIBLE WITH



AND

RATED VOLTAGE  
**20V**  $\equiv$

ROTATION SPEED  
**8000min<sup>-1</sup>**

CUTTING WIDTH  
**Ø250mm**

TELESCOPIC SHAFT  
**6cm → 41cm**

TOTAL LENGTH  
**90cm → 125cm**

THREAD LENGTH  
**6m - Ø1.6mm**



NOT INCLUDED  
NIET INBEGREPEN  
NON INCLUS  
NICHT ENTHALTEN  
NO INCLUIDO  
NON INCLUSO

ADJUSTABLE AUXILIARY HANDLE (4 POSITIONS)

ADJUST BUTTON CUTTING ANGLE

SAFETY GUARD

EDGE GUIDE WHEEL

FLOWER GUARD

INCLUDED ACCESSORIES:  
1x SPOOL TWISTED THREAD (MOUNTED)



5 400338 083280

5 400338 090988

**POWDPG75420**

**GRASS TRIMMER** + 1 CHARGER  
+ 1 BATTERY 20V LI-ION

GRASTRIMMER + LADER + BATTERIJ 20V LI-ION  
COUPE-BORDURE + CHARGEUR + BATTERIE 20V LI-ION  
RASENTRIMMER + LADEGERÄT + AKKU 20V LI-ION  
CORTABORDES + CARGADOR + BATERÍA 20V LI-ION  
TAGLIAERBA + CARICABATTERIE + BATTERIA 20V LI-ION

**20 VOLT TOOL**

COMPATIBLE WITH

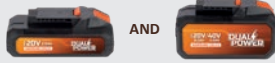

AND

INCLUDED IN THIS PROMO PACK:

**POWDPG7541:** GRASS TRIMMER

**POWDP9021:** BATTERY 20V  $\equiv$  2.0Ah

**POWDP9051:** CHARGER 4.0A

INCLUDED ACCESSORIES:  
1x SPOOL TWISTED THREAD (MOUNTED)

**PROMO PACK**



**POWDPG7546**

# GRASS TRIMMER

GRATRIMMER - COUPE-BORDURE - RASENTRIMMER  
CORTABORDES - TAGLIAERBA

**40 VOLT TOOL**

COMPATIBLE WITH



RATED VOLTAGE  
**40V**

ROTATION SPEED  
**8000min<sup>-1</sup>**

CUTTING WIDTH  
**Ø300mm**

TELESCOPIC SHAFT  
**42cm → 77cm**

TOTAL LENGTH  
**125cm → 160cm**

THREAD LENGTH  
**10m - Ø1.6mm double thread**



NOT INCLUDED  
NIET INBEGREPEN  
NON INCLUS  
NICHT ENTHALTEN  
NO INCLUIDO  
NON INCLUSO



ADJUSTABLE AUXILIARY HANDLE (7 POSITIONS)



EDGE GUIDE WHEEL

ADJUSTABLE AUXILIARY HANDLE (7 POSITIONS)

ALUMINIUM TELESCOPIC SHAFT 42cm TO 77cm

ADJUST BUTTON CUTTING ANGLE

EDGE GUIDE WHEEL

INCLUDED ACCESSORIES:  
1x SPOOL TWISTED THREAD (MOUNTED)

SAFETY GUARD

FLOWER GUARD



**POWDPG7551**

**BRUSH CUTTER**

BOSMAAIER - DÉBROUSSAILLEUSE - FREISCHNEIDER  
DESBROZADORA - DECESPUGLIATRICE

**40  
VOLT  
TOOL**

COMPATIBLE  
WITH



RATED VOLTAGE  
**40V**

ROTATION SPEED  
**7500min<sup>-1</sup>**

CUTTING WIDTH  
GRASS TRIMMER **Ø320mm**  
BRUSH CUTTER **Ø255mm**

THREAD LENGTH  
**5m - Ø1.6mm double thread**

BLADE DIMENSIONS  
**Ø255x25.4mm - 3T**

TELESCOPIC SHAFT  
**101cm**

**BRUSHLESS MOTOR**

INCLUDED ACCESSORIES:  
1x SPOOL TWISTED THREAD  
1x CUTTING BLADE



**ADVANTAGES  
COMPARED TO A BRUSHED MOTOR**

- +50% LIFETIME**
- +50% AUTONOMY**
- +50% POWER**



SHOULDER  
STRAP



NOT INCLUDED  
NIET INBEGREPEN  
NON INCLUS  
NICHT ENTHALTEN  
NO INCLUIDO  
NON INCLUSO



**2-in-1**





POWDPG7553

## 4-IN-1 GARDEN MULTITOOL

TUIN MULTITOOL - MULTI-OUTIL DE JARDIN - GARTEN MULTITOOL  
MULTIHERRAMIENTA DE JARDÍN - MULTITOOL DA GIARDINO

**40 VOLT TOOL**

COMPATIBLE WITH



RATED VOLTAGE  
40V

ROTATION SPEED  
7000min<sup>-1</sup>

**BRUSHLESS MOTOR**

**GRASS TRIMMER/ BRUSH CUTTER**

CUTTING WIDTH  
GRASS TRIMMER Ø320mm  
BRUSH CUTTER Ø255mm

THREAD LENGTH  
5m - Ø2mm double thread

**HEDGE TRIMMER**

BLADE LENGTH  
410mm / 16"

KNIFE DISTANCE  
22mm

**CHAINSAW**

BLADE LENGTH  
200mm / 8"

CHAIN SPEED  
7m/s



INCLUDED ACCESSORIES:  
1x SPOOL TWISTED THREAD  
1x CUTTING BLADE  
1x CHAIN



NOT INCLUDED  
NIET INBEGREPEN  
NON INCLUS  
NICHT ENTHALTEN  
NO INCLUIDO  
NON INCLUSO

**BRUSHLESS MOTOR**



**ADVANTAGES  
COMPARED TO A BRUSHED MOTOR**

+50% LIFETIME  
+50% AUTONOMY  
+50% POWER



SHOULDER STRAP

**4-in-1**

SHAFT LENGTH  
MAX. 100cm

SAFETY  
GUARD

5 400338 090745



# CHOOSE YOUR CORDLESS LAWNMOWER

	POWDPG7568	POWDPG75610	POWDPG75561
Rated voltage	40V <sub>Li</sub>	40V <sub>Li</sub>	20V <sub>Li</sub>
Cutting width	510mm	420mm	340mm
Adjustable cutting height	30-80mm 6 positions	25-75mm 6 positions	25-65mm 5 positions
Collection bag	70L	50L	30L
For lawn size up to	1200m <sup>2</sup>	500m <sup>2</sup>	250m <sup>2</sup>
Housing	Steel	Plastic	Plastic
Self-propelled	Yes	No	No
Brushless motor	Yes	Yes	Yes
Mulching function	Yes	No	No

The central cutting height adjustment is an easy and user-friendly way to change the lawnmowers' cutting height, no tools needed. As a rule of thumb, it is recommended to cut maximum 1/3 of the grass' height. Therefore it is important to choose the correct height setting. The wider the range and the more pre-defined positions, the more precise the end result will be.

The lawnmowers' mulching function helps to maintain a healthy and green lawn. Mulch is a fine layer of fine cut grass that decomposes rapidly, putting nutrients back into the soil. It also protects your lawn from heat and draught, by retaining water more easily. Mulch gets made by re-circulating and re-cutting the grass clippings under the mowing deck, after which it gets forcibly returned to the lawn.



**DUAL  
POWER**  
choose your battery

POWDPG7568

**1 BATTERY**  
**NORMAL RUNTIME**

**2 BATTERIES**  
**DOUBLE RUNTIME**



**BRUSHLESS**  
MOTOR



**ADVANTAGES**  
COMPARED TO A BRUSHED MOTOR

- +50% LIFETIME
- +50% AUTONOMY
- +50% POWER



POWDPG75561

## LAWNMOWER

GRASMAAIER - TONDEUSE À GAZON - RASENMÄHER  
CORTACÉSPED - RASAERBA

**20  
VOLT  
TOOL**

COMPATIBLE  
WITH



AND



RATED VOLTAGE  
20V

CUTTING WIDTH  
340mm

CUTTING HEIGHTS  
5 positions  
25 → 65mm

COLLECTION BAG  
30L

**BRUSHLESS MOTOR**

2 FUNCTIONS  
rear discharge  
collecting

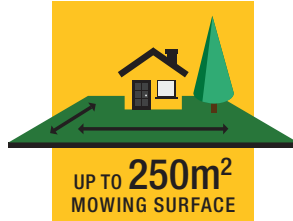

5 400338 109584 6 >

### BRUSHLESS MOTOR



**ADVANTAGES  
COMPARED TO A BRUSHED MOTOR**

+50% LIFETIME  
+50% AUTONOMY  
+50% POWER

CENTRAL ADJUSTABLE  
HEIGHT SETTING

FULL BOX  
INDICATOR



TOP CARRYING  
HANDLE



POWDPG75565

**LAWNMOWER + GRASS TRIMMER** + 1 CHARGER  
+ 1 BATTERY 20V LI-ION

**PROMO PACK**

GRASMAAIER + GRASTRIMMER + LADER + BATTERIJ 20V LI-ION  
TONDEUSE À GAZON + COUPE-BORDURE + CHARGEUR + BATTERIE 20V LI-ION  
RASENMÄHER + RASENTRIMMER + LADEGERÄT + AKKU 20V LI-ION  
CORTACÉSPED + CORTABORDES + CARGADOR + BATERIA 20V LI-ION  
RASAERBA + TAGLIAERBA + CARICABATTERIE + BATTERIA 20V LI-ION

**20  
VOLT  
TOOL**

COMPATIBLE  
WITH



AND



INCLUDED IN THIS PROMO PACK:

**POWDPG75561:** LAWMOWER

**POWDPG75415:** GRASS TRIMMER

**POWDP9021:** BATTERY 20V= 2.0Ah

**POWDP9051:** CHARGER 4.0A

INCLUDED ACCESSORIES:  
2x TRIMMER BLADE



**BRUSHLESS  
MOTOR**

**ADVANTAGES  
COMPARED TO A BRUSHED MOTOR**

- +50% LIFETIME
- +50% AUTONOMY
- +50% POWER



UP TO **250m<sup>2</sup>**  
MOWING SURFACE



5 4003381096860

**POWDPG75415**

RATED VOLTAGE  
**20V =**

ROTATION SPEED  
**8500min<sup>-1</sup>**

CUTTING WIDTH  
**Ø240mm**

TOTAL LENGTH  
**81 → 104.5cm**

CUTTING HEAD  
**with 2 blades**

**POWDPG75610**

**LAWNMOWER**

GRASMAAIER - TONDEUSE À GAZON - RASENMÄHER  
CORTACÉSPED - RASAERBA

**40  
VOLT  
TOOL**

COMPATIBLE  
WITH

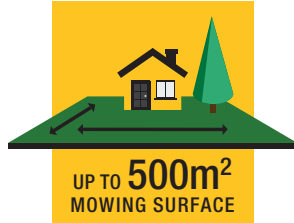

RATED VOLTAGE  
**40V**

CUTTING WIDTH  
**420mm**

CUTTING HEIGHTS  
**6 positions**  
**25 → 75mm**

COLLECTION BAG  
**50L**

**BRUSHLESS MOTOR**

2 FUNCTIONS  
rear discharge  
collecting

**BRUSHLESS  
MOTOR**



**ADVANTAGES  
COMPARED TO A BRUSHED MOTOR**

**+50% LIFETIME**  
**+50% AUTONOMY**  
**+50% POWER**

CENTRAL  
ADJUSTABLE  
HEIGHT  
SETTING

EASY START

FOLDABLE  
HANDLE

FULL BOX  
INDICATOR



EXTRA SLOT FOR STORAGE  
OF SPARE BATTERY



TOP CARRYING  
HANDLE



POWDPG75621

**LAWNMOWER + GRASS TRIMMER** + 1 CHARGER  
+ 1 BATTERY 2x20V LI-ION

**PROMO PACK**

GRASMAAIER + GRASTRIMMER + LADER + BATTERIJ 2x20V LI-ION  
TONDEUSE À GAZON + COUPE-BORDURE + CHARGEUR + BATTERIE 2X20V LI-ION  
RASENMÄHER + RASENTRIMMER + LADEGERÄT + AKKU 2X20V LI-ION  
CORTACÉSPED + CORTABORDES + CARGADOR + BATERIA 2x20V LI-ION  
RASAERBA + TAGLIAERBA + CARICABATTERIE + BATTERIA 2x20V LI-ION



COMPATIBLE WITH



AND



COMPATIBLE WITH



**GRASS TRIMMER**

INCLUDED IN THIS PROMO PACK:

**POWDPG75610:** LAWMOWER 40V

**POWDPG75415:** GRASS TRIMMER

**POWDP9037:** BATTERY 2x20V=  
5.0Ah on a 20V tool  
2.5Ah on a 40V tool

**POWDP9051:** CHARGER 4.0A

INCLUDED ACCESSORIES:  
2x TRIMMER BLADE

**LAWNMOWER**

5 4003381096877

**BRUSHLESS MOTOR**

**ADVANTAGES**  
COMPARED TO A BRUSHED MOTOR

- +50% LIFETIME
- +50% AUTONOMY
- +50% POWER

UP TO **500m<sup>2</sup>**  
MOWING SURFACE



ADJUSTABLE AUXILIARY HANDLE

STORAGE COMPARTMENT FOR SPARE BLADES

TOTAL LENGTH 945-1235mm

FLOWER GUARD

**POWDPG75415**

RATED VOLTAGE **20V** =

ROTATION SPEED **8500min<sup>-1</sup>**

CUTTING WIDTH **Ø240mm**

TOTAL LENGTH **81 → 104.5cm**

CUTTING HEAD with 2 blades

POWDPG7568

# LAWNMOWER

GRASMAAIER - TONDEUSE À GAZON - RASENMÄHER  
CORTACÉSPED - RASAERBA

**40  
VOLT  
TOOL**

COMPATIBLE  
WITH



RATED VOLTAGE  
40V  $\approx$

CUTTING WIDTH  
510mm

CUTTING HEIGHTS  
6 positions  
30 → 80mm

COLLECTION BAG  
70L

**BRUSHLESS MOTOR**

4 FUNCTIONS  
rear discharge  
side discharge  
mulching  
collecting

**BRUSHLESS  
MOTOR**



**ADVANTAGES  
COMPARED TO A BRUSHED MOTOR**

+50% LIFETIME  
+50% AUTONOMY  
+50% POWER



**1 BATTERY  
NORMAL RUNTIME**

**2 BATTERIES  
DOUBLE RUNTIME**



**SELF-  
PROPELLED**  
EXTRA COMFORTABLE MOWING

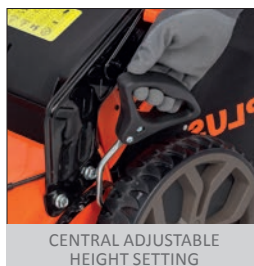



POWDPG7572

## CORDLESS PRUNER SAW

SNOERLOZE SNOEIZAAG – ÉLAGEUSE SANS FIL – SCHNURLOSE ASTSÄGE  
SIERRA DE PODAR INALÁMBRICA – SEGACCIO DA GIARDINO ELETTRICO

**20 VOLT**  
TOOL

COMPATIBLE WITH



AND



RATED VOLTAGE  
**20V**

CHAIN SPEED  
**6.7m/s**

BAR SIZE  
**100mm / 4"**



NOT INCLUDED  
NIET INBEGREPEN  
NON INCLUS  
NICHT EENTHALTEN  
NO INCLUIDO  
NON INCLUSO



INCLUDED ACCESSORIES:  
1x CHAIN (MOUNTED)



5 400338 097881



**POWDPG7570**  
**CHAINSAW**

KETTINGZAAG - TRONÇONNEUSE - KETTENSÄGE  
MOTOSIERRA - MOTOSEGA

**20 VOLT TOOL**

COMPATIBLE WITH

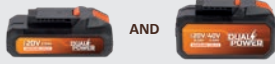

AND

RATED VOLTAGE  
**20V**

CHAIN SPEED  
**5.6m/s**

BAR SIZE  
**300mm / 12"**

OIL TANK CAPACITY  
**220ml**



1L: POWOIL003  
5L: POWOIL006



NOT INCLUDED  
NIET INBEGREPEN  
NON INCLUS  
NICHT ENTHALTEN  
NO INCLUIDO  
NON INCLUSO



INCLUDED ACCESSORIES:  
1x CHAIN



**POWDPG7576**  
**CHAINSAW**

KETTINGZAAG - TRONÇONNEUSE - KETTENSÄGE  
MOTOSIERRA - MOTOSEGA

**40 VOLT TOOL**

COMPATIBLE WITH



**BRUSHLESS MOTOR**



**ADVANTAGES  
COMPARED TO A BRUSHED MOTOR**

**+50% LIFETIME  
+50% AUTONOMY  
+50% POWER**



INCLUDED ACCESSORIES:  
1x CHAIN



POWDPG75385

# TELESCOPIC CHAINSAW

TELESCOPISCHE KETTINGZAAG - TRONÇONNEUSE TÉLESCOPIQUE - TELESKOP-KETTENSÄGE  
MOTOSIERRA TELESCÓPICO - MOTOSEGA TELESCÓPICO

**40 VOLT TOOL**

COMPATIBLE WITH



RATED VOLTAGE  
**40V**

CHAIN SPEED  
**4.5m/s**

BAR SIZE  
**250mm / 10"**

OIL TANK CAPACITY  
**100ml**

TELESCOPIC SHAFT  
**86cm → 147cm**

TOTAL LENGTH  
**175cm → 240cm**



SHOULDER STRAP



BLADE GUARD

1L: POWOIL003  
5L: POWOIL006

NOT INCLUDED  
NIET INBEGREPEN  
NON INCLUS  
NICHT ENTHALTEN  
NO INCLUIDO  
NON INCLUSO



ADJUSTABLE HEAD



PREMIUM QUALITY CHAIN AND BAR

5 400338 092893

INCLUDED ACCESSORIES:  
1x CHAIN

POWDPG8020

## LAWN SCARIFIER / AERATOR

VERTICUTEERDER/VERLUCHTER - SCARIFICATEUR/AÉRATEUR - VERTIKUTIERER/RASENLÜFTER  
ESCARIFICADOR/AIREADOR - SCARIFICATORE/ARIEGGIATORE

**40  
VOLT  
TOOL**

COMPATIBLE  
WITH



**BRUSHLESS  
MOTOR**



**ADVANTAGES  
COMPARED TO A BRUSHED MOTOR**  
+50% LIFETIME  
+50% AUTONOMY  
+50% POWER

RATED VOLTAGE  
40V  $\equiv$

WORKING WIDTH  
360mm

WORKING DEPTH  
-12mm → 5mm (5 positions)

STEEL NEEDLES  
40

KNIVES  
11

COLLECTION BAG  
45L

**BRUSHLESS MOTOR**



DEPTH ADJUSTMENT  
HANDLE

FOLDABLE  
HANDLE

COLLECTION BAG

5 400338 079801 >

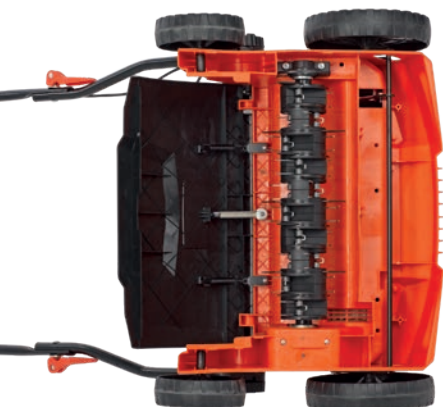

**40  
STEEL NEEDLES**

**11  
KNIVES**



SAFETY KEY



EASY START



NOT INCLUDED  
NIET INBEGREPEN  
NON INCLUS  
NICHT ENTHALTEN  
NO INCLUIDO  
NON INCLUSO

**POWDPG80400**

## PRESSURE SPRAYER

DRUKSPROEIER - PULVÉRISATEUR À PRESSION - DRUCKSPRÜHER  
SULFATADORA PREVIA PRESIÓN - NEBULIZZATORE A PRESSIONE

**20 VOLT TOOL**

COMPATIBLE WITH



AND



RATED VOLTAGE  
**20V**

MAX. PRESSURE  
**5bar**

MAX. FLOW RATE  
**500ml/min**

NETTO WEIGHT  
**1.9kg**

TANK CAPACITY  
**4L**



SHOULDER STRAP



NOT INCLUDED  
NIET INBEGREPEN  
NON INCLUS  
NICHT ENTHALTEN  
NO INCLUIDO  
NON INCLUSO



5 400338 092558

**POWDPG80460**

## PRESSURE SPRAYER BACKPACK

DRUKSPROEIER RUGZAK - PULVÉRISATEUR À PRESSION SAC À DOS - DRUCKSPRÜHER RUCKSACK  
SULFATADORA PREVIA PRESIÓN MOCHILA - NEBULIZZATORE A PRESSIONE ZAINO

**20 VOLT TOOL**

COMPATIBLE WITH



AND



RATED VOLTAGE  
**20V**

MAX. PRESSURE  
**6bar**

MAX. FLOW RATE  
**1500ml/min**

NETTO WEIGHT  
**3.7kg**

TANK CAPACITY  
**16L**

INCLUDED ACCESSORIES:  
4x NOZZLE



NOT INCLUDED  
NIET INBEGREPEN  
NON INCLUS  
NICHT ENTHALTEN  
NO INCLUIDO  
NON INCLUSO



5 400338 093784

POWDPG80620

## HIGH PRESSURE CLEANER

HOGEDRUKREINIGER - NETTOYEUR HAUTE PRESSION - HOCHDRUCKREINIGER  
HIDROLIMPIADORA - IDROPULTRICE

**20 VOLT TOOL**

COMPATIBLE WITH



AND



RATED VOLTAGE  
20V  $\equiv$

MAX. PRESSURE  
25bar

MAX. FLOW RATE  
170 l/h

SOAP BOTTLE  
400ml

HOSE  
6m + filter

SPRAYING PATTERNS  
5

**BRUSHLESS MOTOR**



**ADVANTAGES  
COMPARED TO A BRUSHED MOTOR**

+50% LIFETIME  
+50% AUTONOMY  
+50% POWER

### BRUSHLESS MOTOR

### GET TO KNOW THIS PRODUCT

This cordless pressure washer from Dual Power is **ideal for use on the road**. The 20V pressure washer is equipped with a 6m long hose, which can draw water from remote sources, such as a lake, well or pond. Therefore, this is Dual Power tool is perfectly suited for cleaning road or mountain bikes after a muddy ride. It can also come in handy on holiday to give the car a quick rinse. The portable pressure washer can be attached to a regular tap as well, by using a standard garden hose.

The Dual Power pressure washer features a powerful **brushless motor**. It is more durable, extends the battery's autonomy and requires less maintenance. The washer has a flow rate of 170 litres per hour with a maximum water pressure of 25 bar. Switching between low and high pressure is easy.

The 5-in-1 pressure nozzle features **5 different spraying patterns**, ranging from a regular water jet to a powerful precision jet. Extra clean results can be achieved thanks to the detergent tank. It can be attached easily and provides perfectly clean results.



**EXTRA POWERFUL  
max. 25bar**



SPRAY HEAD WITH 5 PATTERNS



400ml SOAP BOTTLE



5 400338 094477



NOT INCLUDED  
NIET INBEGREPEN  
NON INCLUS  
NICHT ENTHALTEN  
NO INCLUIDO  
NON INCLUSO



TRIGGER LOCK

WATER INLET

USE THE TAP OR ANY OTHER AVAILABLE WATER SUPPLY



6m HOSE TO DRAW WATER FROM REMOTE SOURCES

**IDEAL FOR USE ON THE ROAD**



6m SELF-PRIMING TUBE



5 SPRAY PATTERNS



NORMAL/TURBO BUTTON



**POWDPG80621**

**PRESSURE CLEANER** + 1 CHARGER  
+ 1 BATTERY 20V LI-ION

**PROMO PACK**

HOGEDRUKREINIGER + LADER + BATTERIJ 20V LI-ION  
NETTOYEUR HAUTE PRESSION + CHARGEUR + BATTERIE 20V LI-ION  
HOCHDRUCKREINIGER + LADEGERÄT + AKKU 20V LI-ION  
HIDROLIMPIADORA + CARGADOR + BATERÍA 20V LI-ION  
IDROPULTRICE + CARICABATTERIE + BATTERIA 20V LI-ION

**20  
VOLT  
TOOL**

COMPATIBLE  
WITH



AND



INCLUDED IN THIS PROMO PACK:

**POWDPG80620: PRESSURE CLEANER**

**POWDP9021: BATTERY 20V= 2.0Ah**

**POWDP9051: CHARGER 4.0A**

6m HOSE TO DRAW WATER FROM  
REMOTE SOURCES

**IDEAL FOR USE  
ON THE ROAD**

5 400338 094484

**BRUSHLESS  
MOTOR**



**ADVANTAGES  
COMPARED TO A BRUSHED MOTOR**

- +50% **LIFETIME**
- +50% **AUTONOMY**
- +50% **POWER**



5 SPRAY PATTERNS



NORMAL/TURBO BUTTON





**POWDPG8060**

## WEED SWEEPER

ELEKTRISCHE ONKRUIDBORSTEL - DÉSHERBEUR ÉLECTRIQUE - UNKRAUTFUGNEBÜRSTE  
CEPILLO ELÉCTRICO PARA MALEZAS - SPAZZATRICE PER ERBACCE

**20  
VOLT  
TOOL**

COMPATIBLE  
WITH



AND



RATED VOLTAGE  
**20V**

ROTATION SPEED  
**1400min<sup>-1</sup>**

WIRE BRUSH DISC DIAMETER  
**Ø110mm**

TOTAL LENGTH  
**92cm → 127cm**



EASY RELEASE



**INCLUDED ACCESSORIES:**  
1x WIRE BRUSH DISC STEEL  
1x WIRE BRUSH DISC NYLON





NOT INCLUDED  
NIET INBEGREPEN  
NON INCLUS  
NICHT ENTHALTEN  
NO INCLUIDO  
NON INCLUSO



5 400338 093470





## GRASS TRIMMERS

<b>POWDPG7541</b> GRASS TRIMMER 20V		<b>POWACG1222</b> Spool twisted thread - 2pcs - 6m - 1.6mm	5 400338 091926 >
<b>POWDPG75420</b> GRASS TRIMMER 20V SET		<b>POWACG1222</b> Spool twisted thread - 2pcs - 6m - 1.6mm	5 400338 091926 >
<b>POWDPG7546</b> GRASS TRIMMER 40V		<b>POWACG1241</b> Spool twisted thread - 2pcs - 10m - 1.6mm - double thread	5 400338 091940 >



## BRUSH CUTTERS

<b>POWDPG7551</b> BRUSH CUTTER 40V		<b>POWACG1261</b> Spool 1pc 5m - 2mm - double thread	5 400338 092398 >
		<b>POWACG3021</b> Cutting disc 255x25.4mm - 3T	5 400338 065248 >
		<b>POWACG3041</b> Cutting disc 255x25.4mm - 3T	5 400338 092572 >
<b>POWDPG7553</b> 4-IN-1 GARDEN MULTITOOL 40V		<b>POWACG1261</b> Spool 1pc 5m - 2mm - double thread	5 400338 092398 >
		<b>POWACG3021</b> Cutting disc 255x25.4mm - 3T	5 400338 065248 >
		<b>POWACG4100</b> Chain 200mm - 8" - 33T - OREGON	5 400338 090967 >
		<b>POWACG4400</b> Chain 200mm - 8" - 33T - PREMIUM	5 400338 097430 >

## CHAINSAWS

<b>POWDPG7570</b> CHAINSAW 20V		<b>POWACG4211</b> Chain 300mm - 12" - 45T OREGON	5 400338 056475 >
		<b>POWACG4421</b> Chain 300mm - 12" - 45T PREMIUM	5 400338 097461 >
<b>POWDPG7576</b> CHAINSAW 40V		<b>POWACG4222</b> Chain 350mm - 14" - 53T OREGON	5 400338 052620 >
		<b>POWACG4432</b> Chain 350mm - 14" - 53T PREMIUM	5 400338 097492 >
<b>POWDPG75385</b> TELESCOPIC CHAINSAW 40V		<b>POWACG4412</b> Chain 250mm - 10" - 40T PREMIUM	5 400338 097454 >
<b>POWDPG7572</b> CORDLESS PRUNER SAW 20V		<b>POWACG440</b> Chain 100mm - 4" - 14T PREMIUM	5 400338 097935 >

## WEED SWEEPER

<b>POWDPG8060</b> WEED SWEEPER 20V		<b>POWACG1511</b> Wire brush disc steel Ø110mm	5 400338 094187 >
		<b>POWACG1512</b> Wire brush disc nylon Ø110mm	5 400338 094194 >

## SAFETY

	<b>POWDPGLOVE01</b> WORK GLOVES	5 400338 091513 >
---	------------------------------------	-------------------

# TOOLBOXES

GEREEDSCHAPSKISTEN - BOÎTES À OUTILS - WERKZEUGKASTEN  
CAJAS DE HERRAMIENTAS - CASSETTE UTENSILI



**POWDPTB01** MEDIUM TOOL BOX



52.8 x 37.1 x 17.9 cm  
2x BIN WITH LID  
6x REMOVABLE DIVIDER  
(2x long, 4x short)  
WATER RESISTANT SEAL



WATER-RESISTANT SEAL



STACKABLE

**POWDPTB02** LARGE TOOL BOX



52.8 x 37.1 x 28.4 cm  
WATER RESISTANT SEAL



TOOLS AND BATTERIES  
NOT INCLUDED



**POWDPBAG01** TOOL BAG



40 x 22.5 x 32 cm  
HIGH STRENGTH POLYESTER  
600D  
WATER-RESISTANT BOTTOM

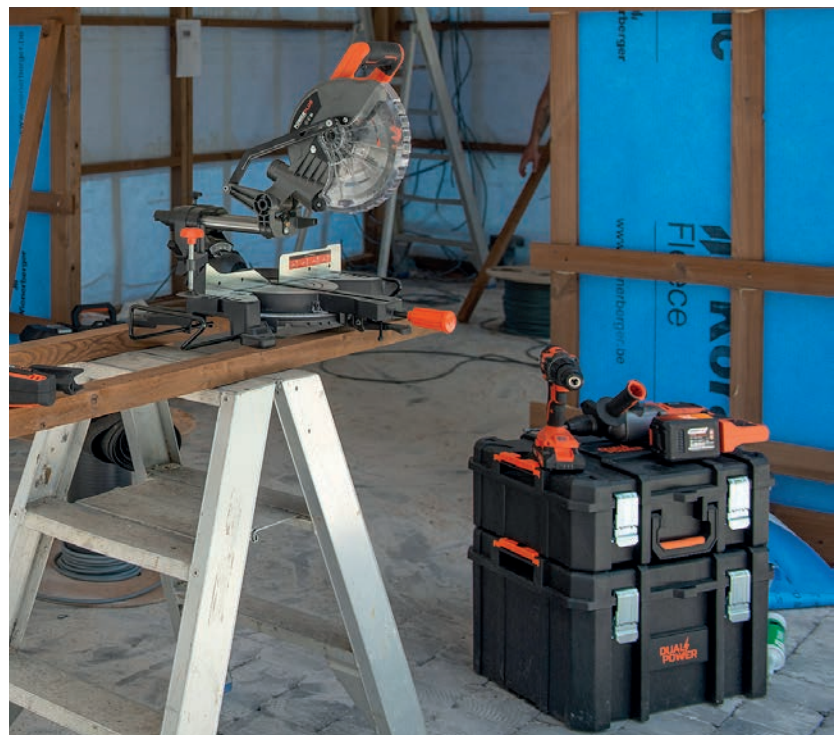

# DUAL POWER

choose your battery

**varo**

**VIC. VAN ROMPUY nv**

JOSEPH VAN INSTRAAAT 9  
2500 LIER - BELGIUM

TEL +32 3 292 92 92 - FAX +32 3 292 92 72  
INFO@VARO.COM - WWW.VARO.COM

CAT22010099 - PRINTED FEBRUARY 2023

@ COPYRIGHT VARO - VIC. VAN ROMPUY NV 2023 / PRODUCT SPECIFICATIONS ARE SUBJECT TO CHANGE WITHOUT NOTICE. VARO IS NOT RESPONSIBLE FOR TYPOGRAPHICAL OR PHOTOGRAPHIC ERRORS THAT MAY APPEAR IN THIS CATALOGUE. PICTURES MAY VARY FROM THE ACTUAL PRODUCTS. WE RESERVE THE RIGHT TO MAKE ADJUSTMENTS OR CORRECTIONS DUE TO ERRORS, CHANGING MARKET CONDITIONS, PRODUCT DISCONTINUATIONS, OR TYPOGRAPHIC OR PHOTOGRAPHIC ERRORS IN ADVERTISEMENTS OR PRODUCT DESCRIPTIONS. ITEM AVAILABILITY AND PRICES ARE SUBJECT TO CHANGE WITHOUT NOTICE.

