

EN

HS 8100.2

HS 8004.03.03
www.liebherr.com

LIEBHERR

Construction machines



Concept and characteristics

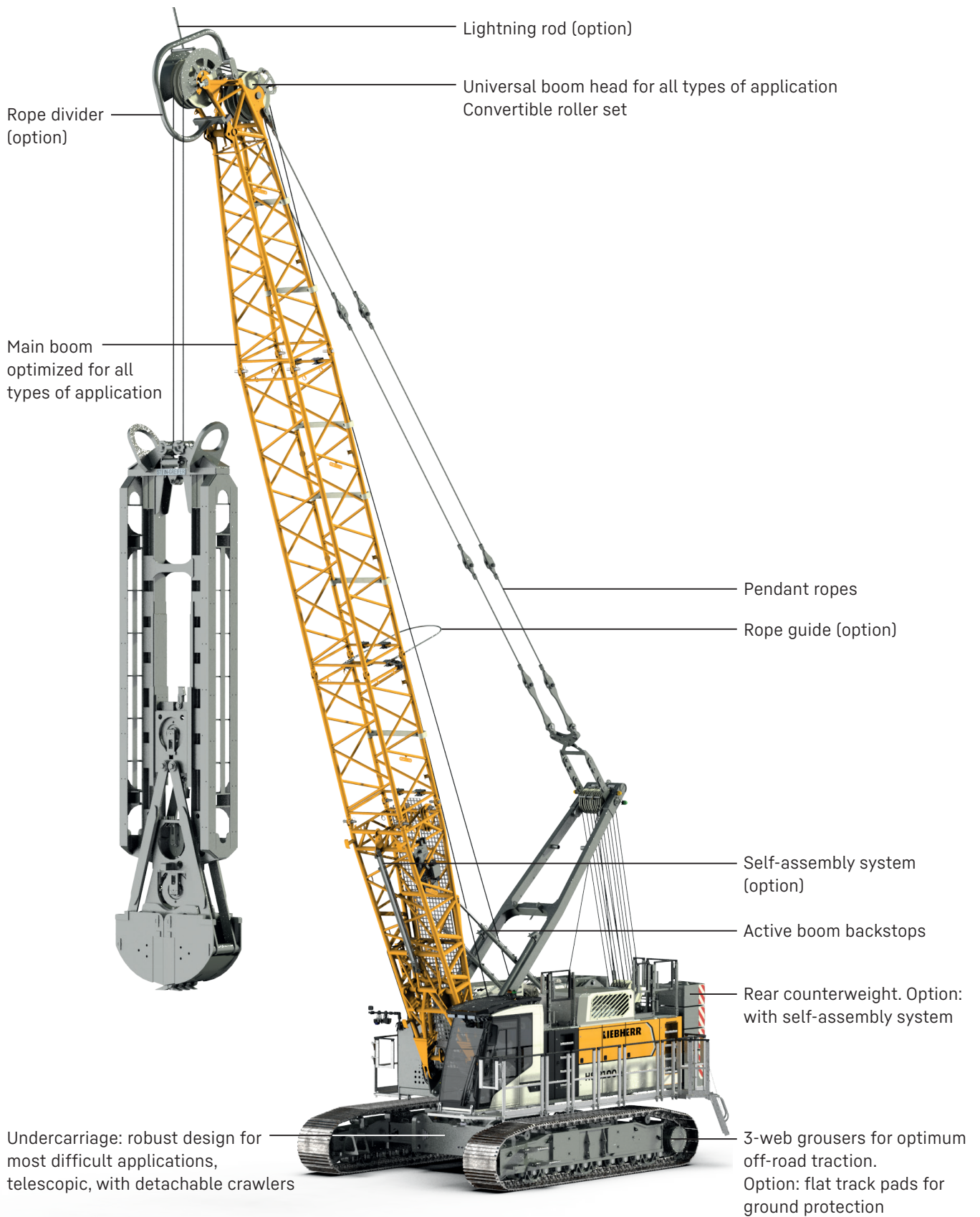

Operating comfort



The newly developed cabin combines operator comfort with easy handling.

Air conditioning combined with an air-suspended seat offers an ideal workplace for the operator.

- Front pane, roof pane and right-hand side pane, armoured glass as a standard
- Completely new cabin design focusing on ergonomics and operating comfort
- Improved soundproofing
- Orthopaedic seat, heatable, coolable and ventilated
- Individually adjustable monitors
- Charger for mobile devices
- Heated outside mirror

Eco-silent package

- Eco-silent mode
With the aid of this feature, which is mainly used in dragline operation, the engine speed is reduced to a required predefined level. This also reduces noise emission.
- Automatic engine stop control
This control system switches the engine off automatically during longer idling periods, after having checked certain system functions. This reduces the operating hours of the machine and at the same time extends the service intervals, which leads to a reduction in operating costs.
- Lower engine speed while idling
Construction machines are in idling mode for 45 % of their operating time. With the lowering of the engine speed from 950 rpm to 750 rpm while the machine is in idling mode, up to 2 litres of fuel can be saved per hour.

Maintenance



Gear oil level warning

The new warning allows the operator to check the gear oil levels of both main winches, the swing drive and the luffing winch. This facilitates daily maintenance of the machine.

Example



Gear oil level warning of winch 1 lights up green: Gear oil level of winch 1 is sufficient.



Gear oil level warning of winch 1 lights up yellow after ten seconds: Fill gear oil for winch 1.



Ground pressure visualisation



Refuelling

Thanks to a new concept, refuelling is no longer carried out via the roof of the uppercarriage but via the walkway with easy and safe access.

A refuelling pump is available as an option – for both diesel and urea.

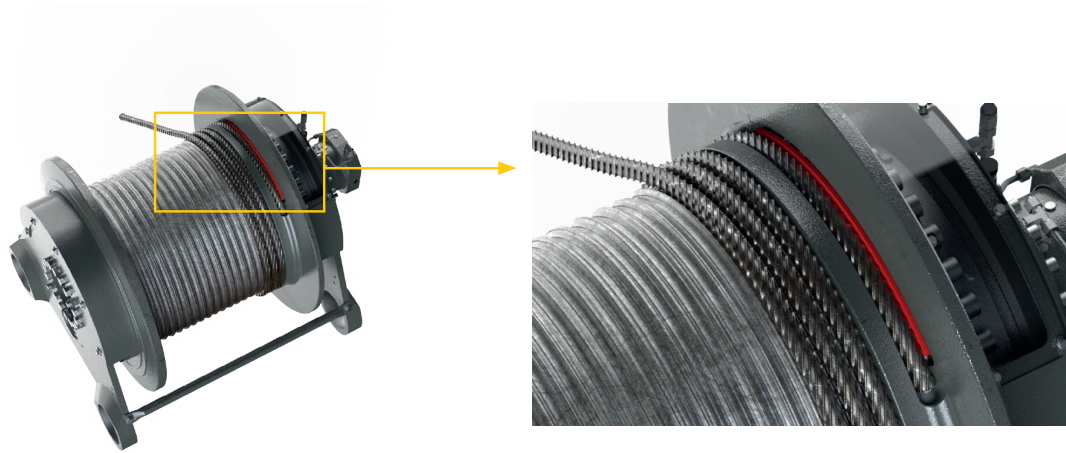

Rope lock

The 30-tonne winches are equipped with a new rope lock. This means that the ropes can be replaced more quickly and more easily, which reduces downtime.

A rope-reeving winch is available as an option, which makes changing the rope even easier. There is also a rope tensioning pulley for slurry wall grab operation.

A radio remote control is available for safe rope changes.

Technical description



Operating weights

Composition of operating weight	The operating weight includes the basic machine with HD undercarriage, 2 main winches 295 kN including wire ropes (90 m) and 11 m main boom, consisting of A-frame, boom foot (5.5 m) and boom head (5.5 m), 26.3 t rear counterweight, 800 mm 3-web grousers and 60 t hook block
Total weight	approx. 89 t

Ground pressure

Ground pressure	1.04 kg/cm ²
------------------------	-------------------------

Equipment

Main boom (1311.24)	lifting operation	max. 59 m
	with fixed jib	max. 38 m
	duty cycle operation	max. 32 m

Diesel engine

Power rating according to ISO 9249	450 kW (603 hp) at 1700 rpm
Engine type	Liebherr D 966 A7-05
Fuel tank capacity	790 l with continuous level indicator and reserve warning
AdBlue tank capacity	78 l with continuous level indicator and reserve warning
Exhaust certification	97/68 EC Stage IV; EPA/CARB Tier 4f 97/68 EC Stage V; EPA/CARB Tier 4f

Noise measurement data and vibration

Noise emission	according to 2000/14/EC directive	
Emission sound pressure level L_{PA}	74 dB(A)	(in the cabin)
Guaranteed sound power level L_{WA}	107 dB(A)	(of the machine)
Vibration transmitted to the machine operator	< 2.5 m/s ²	(to the hand-arm system)
	< 0.5 m/s ²	(to the whole body)

Hydraulic system

Hydraulic pumps	variable pumps in closed and open circuits supplying oil only when needed (flow control on demand)
Hydraulic oil tank capacity	860 l
Max. working pressure	400 bar
Max. power at the connection plate	300 kW (2x 305 l/min) for external appliances
Hydraulic oil	electronic monitoring of all filters use of synthetic environmentally friendly oil possible
Hydraulic retrofit kits for attachments	ready-made customized hydraulic retrofit kits are available e.g. powering casing oscillators, vibrators, hydraulic grabs, fixed leaders

Hoisting gear

Main winches	pressure controlled, variable flow hydraulic motors for the drag and hoist winches, full utilisation of engine power as the winch speed is automatically adjusted to suit the respective line pull Free fall: clutch and braking functions are provided by the service brake (low wear and maintenance-free multi-disc brake in compact design)
Winch options	
Line pull in the 1st layer	295 kN
Rope diameter	34 mm
Drum diameter	750 mm
Rope speed	0-96 m/min
Rope capacity in the 1st layer	35.3 m*
Rope capacity in the 3rd layer	140.7 m*
	* effective length
Options	
Auxiliary winch	70 kN in boom foot
Tagline winch	30 kN with free fall

Boom winch

Line pull	max. 105 kN
Rope diameter	20 mm
Boom luffing	15-84° in 44 s

Crawlers

Drive system	with fixed axial piston hydraulic motors
Crawler side frames	maintenance-free, with hydraulic chain tensioning device
Brake	hydraulically released, spring-loaded multi-disc holding brake
Drive speed	0-1.28 km/h
Grousers	3-web grousers, width 800 mm
Width of undercarriage	automatic track width adjustment from transport width to operating width via hydraulic cylinders
Options	self-assembly system, jack-up system 3-web grousers, width 900 mm flat track pads, width 900 mm 3-web grousers, width 1000 mm

Swing gear

Drive system	with fixed axial piston hydraulic motors, planetary gearbox, pinion
Swing ring	roller bearing with external teeth
Brake	hydraulically released, spring-loaded multi-disc holding brake
Swing speed	0-4 rpm continuously variable, selector for 3 speed ranges to increase swing precision
Lubrication system	automatic central lubrication system reduces maintenance requirements and increases service life
Option	display of swing angle second swing drive

Control

Control	includes all control and monitoring functions, designed to withstand extreme environmental conditions and heavy duty construction tasks
Display	high resolution monitor in the operator's cabin, clear display of complete machine operating data, warnings and failure indications in the required language
Operation	several movements can be performed simultaneously thanks to electro-hydraulic proportional control, all categories of loads can be positioned with utmost precision
Options	PDE*: process data recording LiTU: Liebherr Telematics Unit

Dimensions

Basic machine with undercarriage

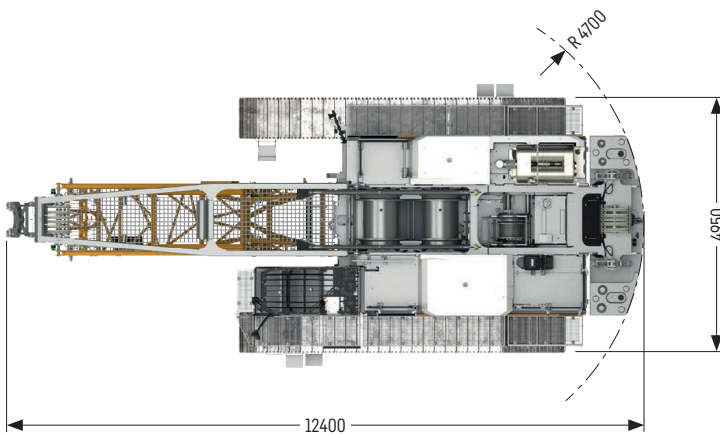
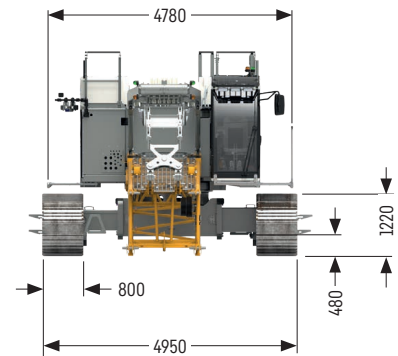
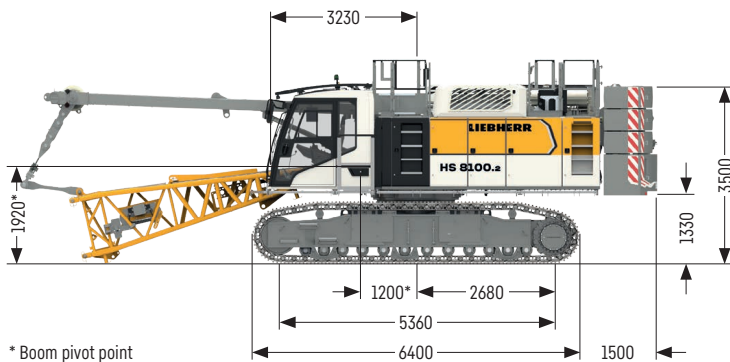

Remarks

- Liebherr cable excavator HS 8004.02.04
- Designed according to EN 474-1 and EN 474-12.
- Machine is standing on firm, horizontal ground.
- The weight of the lifting device (pulley block, hoist ropes, shackles etc.) must be deducted from the load capacity.
- Additional equipment on boom (e.g. walkways) must be deducted from the lifting capacity.
- For max. wind speed please refer to lift chart in operator's cab or manual.
- Working radii are measured from centre of swing and under load.
- The lifting capacities are valid for 360 degrees of swing.
- The last digits of the given dimensions are rounded to 0 and 5 and may differ from the actual dimensions.
- Weights may vary depending on the delivered configuration of the machine filling level of the tanks as well as generally valid tolerances.
- The figures in this brochure may include options which are not within the standard scope of supply of the machine.

Grab versions

Assistance system

GrabMatic

- Grab visualisation
The status of the grab (open, closed) is shown on the display.
- Slack rope automatic
When positioning the grab, it is possible that slack rope occurs. This is counteracted by the control system.
- Level cutting
This function allows the dredging of a level surface under water to a specified depth.
- Automatic winch synchronisation
Thanks to the automatic winch synchronisation, lifting and lowering is possible with just one control lever.
- Grab filling level
Automatic hoisting and lowering of the grab during dredging enables an optimum filling level of the grab.
- Cycle counter
The number of work cycles is shown on the display.

Dredging interface

The interface allows the integration of different systems with which, for example, the swell compensation can be implemented.





Casing oscillator

Max. drilling diameter	mm 2000
------------------------	---------



HS 8100.2 on pedestal

Power rating of diesel engine	kW 450
Free-fall winches	t 2x 20 or 2x 30
Option:	
Cabin elevation, fixed	m 2.3
Cabin elevation, variable, hydraulic	m 2.8

GrabMatic (option)



Further information on material handling



Capacities in grab operation

Capacities in [t] with 26.3t counterweight

	Boom length [m]							
	11	14	17	20	23	26	29	32
5	45.4	45.4	45.4	45.4	45.4	42.0		
6	45.4	45.4	45.4	45.4	45.4	42.0	38.0	32.0
7	40.0	40.1	40.2	40.2	40.1	40.1	38.0	32.0
8	32.8	32.9	32.9	32.9	32.9	32.8	32.8	32.0
9	27.7	27.8	27.8	27.8	27.7	27.7	27.6	27.6
10	23.8	24.0	24.0	24.0	23.9	23.8	23.8	23.7
11	20.8	21.0	21.0	21.0	20.9	20.9	20.8	20.7
12	18.4	18.6	18.7	18.6	18.6	18.5	18.4	18.3
13		16.7	16.7	16.7	16.6	16.6	16.5	16.4
14		15.0	15.1	15.1	15.0	15.0	14.9	14.8
15		13.6	13.7	13.7	13.7	13.6	13.5	13.4
16			12.6	12.5	12.5	12.4	12.3	12.2
18			10.6	10.6	10.6	10.5	10.4	10.3
20				9.1	9.1	9.0	9.0	8.9
22					7.9	7.9	7.8	7.7
24					6.9	6.9	6.8	6.7
25						6.4	6.4	6.3
26						6.0	6.0	5.9
28							5.3	5.2
30								4.6
32								4.1

TLT 13649087 0 Preliminary_5. Stability calculated according to EN 474-12. Max. capacities do not exceed 66 % of tipping load.

Above capacities are for reference only and are not programmed in the LML system.

When working with a mechanical 2-rope grab the total load to be lifted is limited by the line pull of one winch.

Max. main boom 32m

Max. lifting capacity with mechanical grab is 30 t. For higher lifting capacities a hydraulic grab is required.

Slurry wall grab

Maximum capacity in duty cycle operation with standard ropes

Line pull (1st layer)	kN	295
Rope diameter	mm	34
Minimum breaking load	kN	1046
Line pull - 1-rope duty cycle operation	kN	295
Line pull - 2-rope duty cycle operation ¹⁾	kN	447

1) Lifting a load exceeding the line pull of one winch is only allowed if it can be ensured that each individual winch is not overloaded.
When working with a mechanical 2-rope grab the total load to be lifted is limited by the line pull of one winch.
Rigging and ropes are part of the load.

Capacities in slurry wall operation are for reference only and are not programmed in the LML system.

All loads and counterweight configurations are max. values and must not be exceeded.
Weight of additional equipment on boom (e.g. walkways, hose drums etc.) must be deducted to get the net capacity.



Load chart for slurry wall operation

Capacities in [t] with 26.3 t counterweight

Radius [m]	Boom length [m]					
	17	20	23	26	29	32
5	43.6	43.6	43.6	40.3		
6	43.6	43.6	43.6	40.3	36.5	30.7
7	36.0	36.0	36.0	35.9	35.9	30.7
8	29.5	29.5	29.5	29.5	29.4	29.4
9	25.0	24.9	24.9	24.9	24.8	24.8
10	21.5	21.5	21.4	21.4	21.3	21.3
11	18.8	18.8	18.8	18.7	18.6	18.6
12	16.7	16.7	16.7	16.6	16.5	16.5
13	15.0	15.0	15.0	14.9	14.8	14.7
14	13.5	13.5	13.5	13.4	13.3	13.2
15	12.3	12.3	12.3	12.2	12.1	12.1
16	11.3	11.2	11.2	11.1	11.1	11.0
17	10.4	10.4	10.4	10.3	10.2	10.1
18	9.5	9.6	9.5	9.5	9.4	9.3
19		8.8	8.8	8.7	8.7	8.6
20		8.3	8.3	8.2	8.1	8.0
21		7.7	7.7	7.6	7.5	7.4
22			7.1	7.1	7.0	6.9
23			6.7	6.6	6.5	6.5
24			6.2	6.2	6.1	6.0
25				5.9	5.8	5.7
26				5.5	5.4	5.4
27					5.1	5.0
28					4.8	4.7
29					4.5	4.4
30						4.2
31						3.9
32						3.7

14153212 0 Preliminary_20. Max. main boom 32m

Machine is standing on firm, horizontal ground.

The load capacities do not exceed the stability requirements of EN 16228-5.



For further information please refer to the HSG 5-18 datasheet.

Short boom

Rope diameter	mm	34
Radius	mm	6100 at max. boom angle 28.3° 5100 at min. boom angle 51.4°
Machine height during operation (max.) (min.)	mm	8434 at max. boom angle 28.3° 5900 at min. boom angle 51.4°
Effective rope length	m	38.8
Rear counterweight	t	23.3
Capacity in duty cycle operation	t	37.9 at radius of 5 m 33.6 at radius of 6 m

Machine is standing on firm, horizontal ground.

The load capacities do not exceed the stability requirements of EN 16228-5.

Dynamic soil compaction

Soil compaction control

The soil compaction control makes working with dynamic compaction easier and offers the operator more protection. They can use the system to enter the number of blows per point. The process is documented in the PDE and can be analysed using various systems.

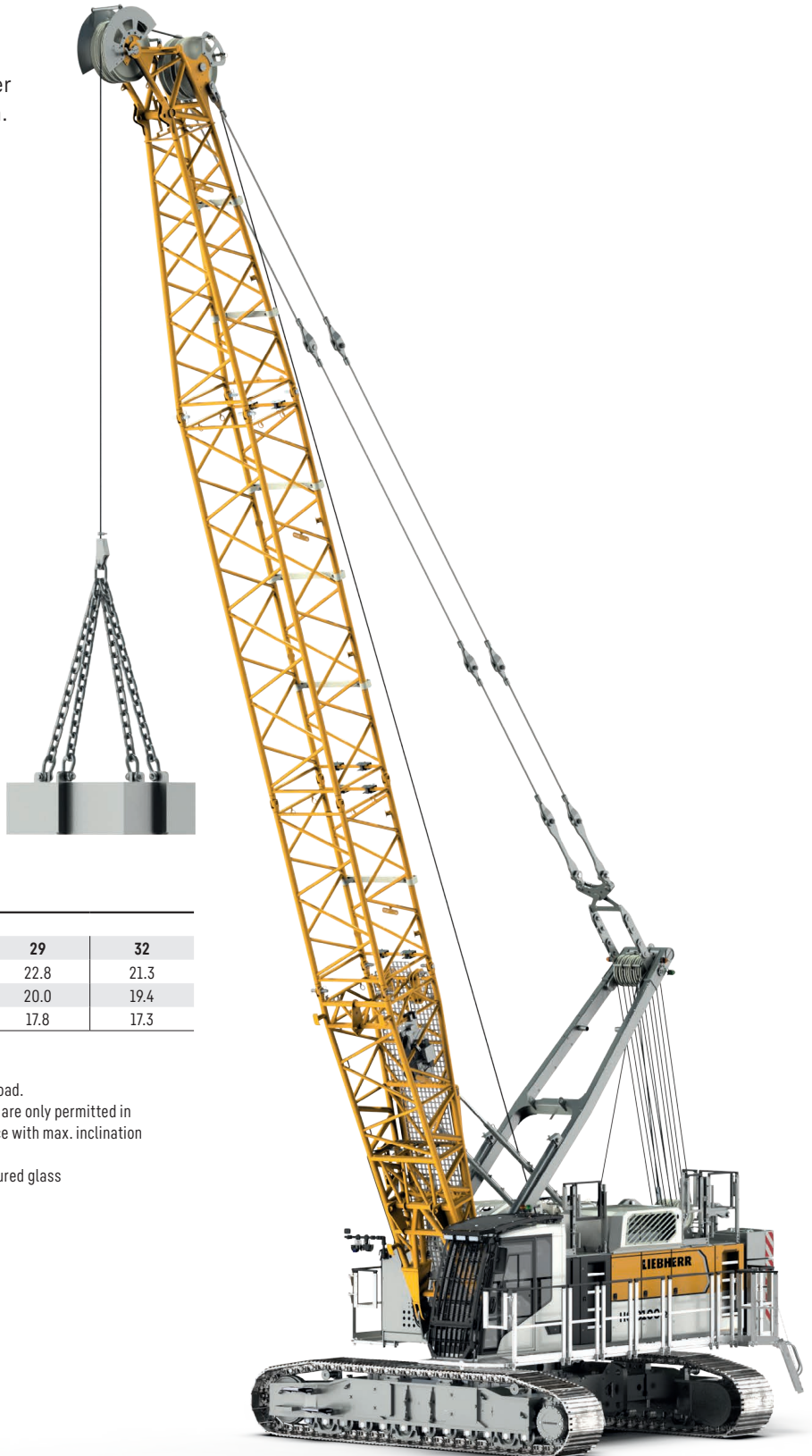

Capacities in [t] with 26.3 t counterweight

Radius [m]	Boom length [m]				
	20	23	26	29	32
8	24.9	24.4	23.6	22.8	21.3
9	21.1	21.0	20.7	20.0	19.4
10		18.1	18.1	17.8	17.3

TLT 13649087 0 Preliminary_5

Max. capacities in metric tonnes do not exceed 75% of tipping load.
 All loads given are max. values and must not be exceeded. They are only permitted in two-rope automatic operation and are valid for work on a surface with max. inclination of 1%. Lifting heights must not exceed 25 m.
 Option: soil compaction control incl. cabin protection and armoured glass
 Max. main boom 32 m

Special applications

- Vibro-flot (deep vibrator)
- Hammer
- Vibrator (free-hanging)
- Shaft excavation
- Rock handling
- Magnet system
- Demolition (longer main booms available on request)

Capacities in [t] with 26.3t counterweight

	Boom length [m]							
	11	14	17	20	23	26	29	32
5	45.4	45.4	45.4	45.4	45.4	42.0		
6	45.4	45.4	45.4	45.4	45.4	42.0	38.0	32.0
7	45.4	45.3	45.4	44.2	42.6	41.1	38.0	32.0
8	37.2	37.4	37.4	37.4	36.6	35.4	34.2	32.0
9	31.4	31.6	31.6	31.6	31.5	31.0	30.0	29.1
10	27.1	27.2	27.2	27.2	27.2	27.1	26.7	25.9
11	23.7	23.8	23.9	23.8	23.8	23.7	23.6	23.2
12	20.9	21.1	21.2	21.2	21.1	21.0	20.9	20.8
13		18.9	19.0	19.0	18.9	18.8	18.7	18.6
14		17.1	17.2	17.1	17.1	17.0	16.9	16.8
15		15.5	15.6	15.6	15.5	15.4	15.4	15.2
16			14.3	14.2	14.2	14.1	14.0	13.9
18			12.1	12.1	12.0	12.0	11.9	11.8
20				10.4	10.4	10.3	10.2	10.1
22					9.0	8.9	8.8	8.7
24					7.9	7.8	7.7	7.6
25						7.3	7.3	7.2
26						6.9	6.8	6.7
28							6.0	5.9
30								5.2
32								4.6

TLT 13649087 0 Preliminary_5. Stability calculated according to EN 474-12. Max. capacities do not exceed 75% of tipping load.

Above capacities are for reference only and are not programmed in the LML system.

Max. main boom 32 m

Dragline equipment

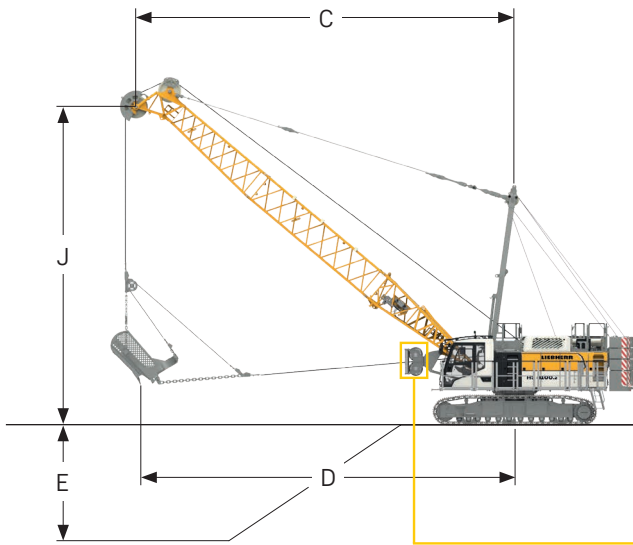

Digging diagram

- C = Radius / dumping radius
- D = Max. digging radius = approx. $C + 1/3$ to $1/2 J$
- E = Digging depth = approx. 40 - 50% of C
- J = Height to centre rope pulley boom head

Rotating fairlead is fitted for dragline operation; diagonal pull limited to a minimum resulting in less rope wear.

Dragline control (Interlock control system)

The Interlock control system allows for power regeneration in dragline operation. This reduces the fuel consumption as well as the wear of the free-fall winch.

Lifting height restriction

It prevents the rope end termination from being pulled into the head pulley in an uncontrolled manner. The drag winch is also equipped with this function.

Capacities in dragline operation

Capacities in [t] with 26.3 t counterweight

alpha [°]	Boom length [m]														
	17			20			23			26			29		
	C	J	*	C	J	*	C	J	*	C	J	*	C	J	*
55	11.9	15.5	21.5	13.6	18.0	17.9	15.3	20.4	15.1	17.1	22.9	12.9	18.8	25.4	11.2
50	13.0	14.6	18.9	15.0	16.8	15.7	16.9	19.2	13.2	18.8	21.4	11.3	20.7	23.7	9.7
45	14.1	13.5	17.1	16.2	15.6	14.1	18.3	17.7	11.8	20.4	19.9	10.0	22.6	22.0	8.6
40	15.0	12.3	15.5	17.3	14.3	12.8	19.6	16.2	10.7	21.9	18.2	9.0	24.2	20.1	7.7
35	15.9	11.1	14.4	18.3	12.8	11.8	20.8	14.6	9.8	23.3	16.3	8.3	25.7	18.0	7.0
30	16.6	9.9	13.5	19.2	11.3	11.0	21.8	12.9	9.1	24.4	14.4	7.7	27.0	15.9	6.5
25	17.2	8.5	12.9	20.0	9.8	10.4	22.7	11.1	8.7	25.4	12.3	7.2	28.1	13.6	6.0

TLT 13649087 0 Preliminary_5. Stability calculated according to EN 474-12. Max. capacities do not exceed 75% of tipping load.

Above capacities are for reference only and are not programmed in the LML system. The size of the bucket has to be determined according to local conditions.

Max. main boom 32 m

* Capacity in t

Planning aid for dragline operation

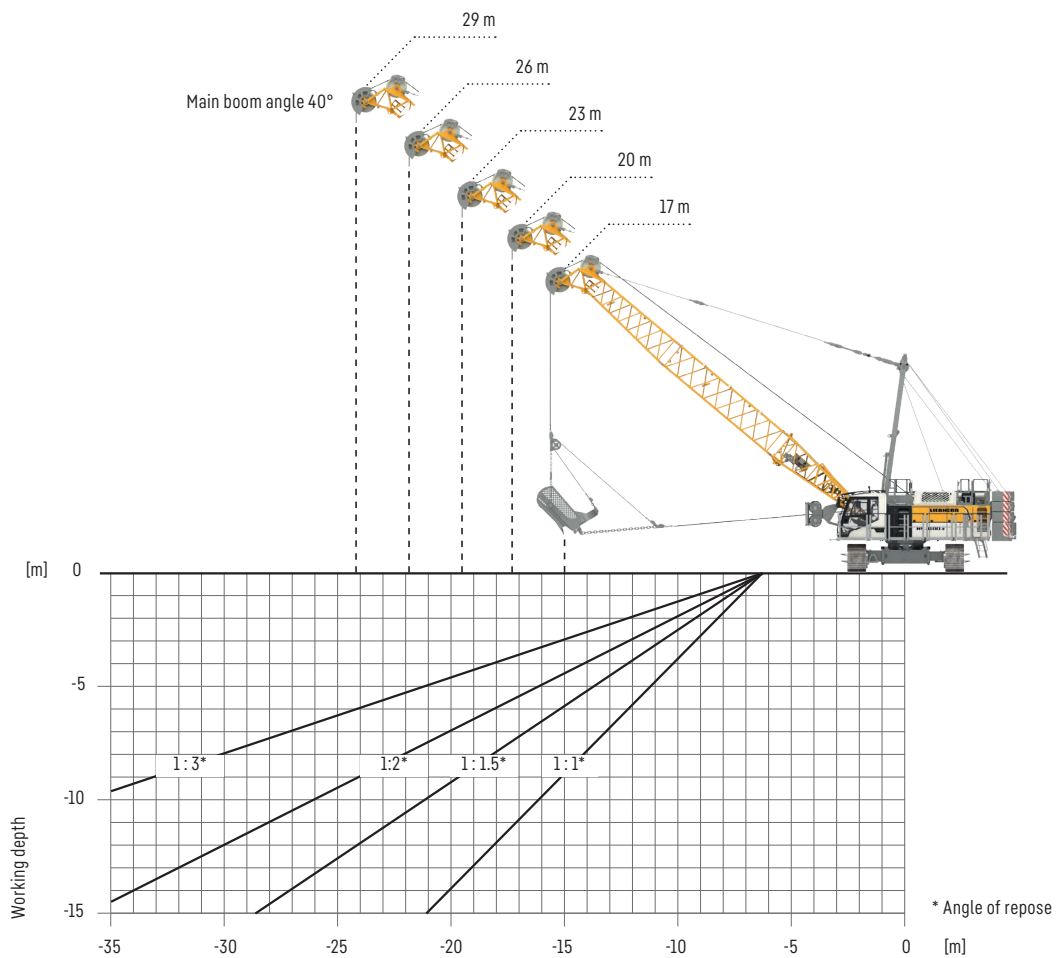

Selection of dragline bucket and possible digging depths at 40° boom angle

Main boom [m]	17	20	23	26	29
Dragline bucket [m³ / yd³]	5.73 / 7.5	4.58 / 6	3.82 / 5	3.06 / 4	2.29 / 3

Density: 1.8 tm³ and fill factor 0.8

* The digging depth depends on the material's angle of repose.

Lifting operation

Main boom 84°-15°

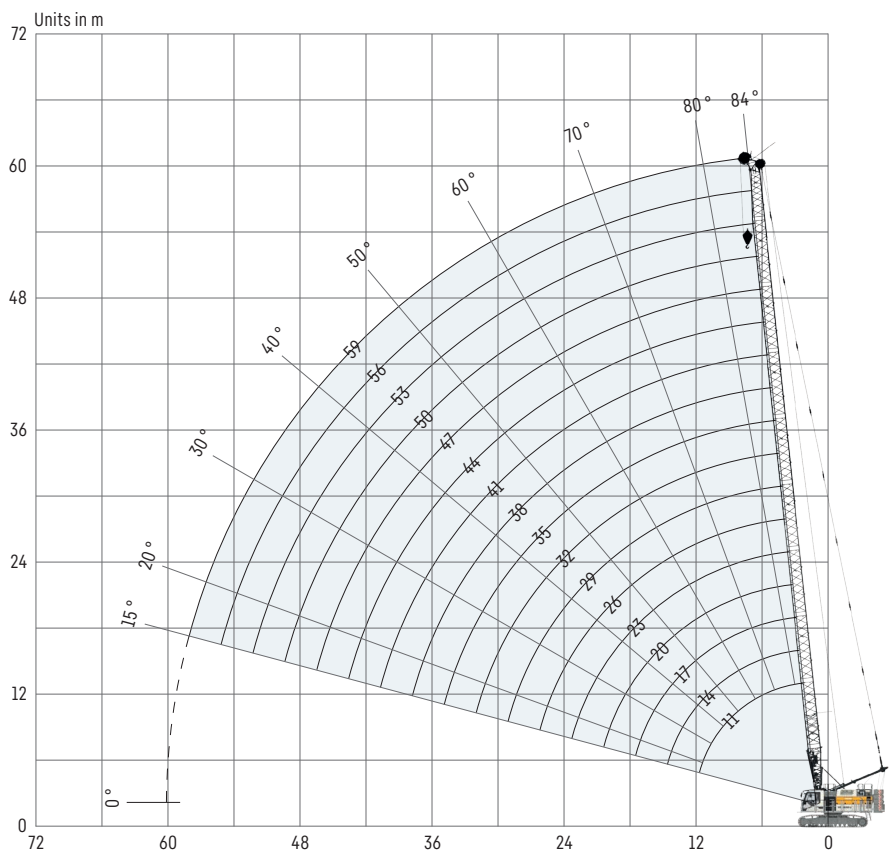

Auxiliary jib 30 t











The maximum capacity of the auxiliary jib is 30 t. The corresponding load chart is programmed in the LML system.

Main boom configuration

Boom section	Amount of boom sections																
Boom foot 5.5 m	1	1	1	1	1	1	1	1	1	1	1	1	1	1	1	1	1
Boom section 3 m		1		1		1		1		1		1		1		1	
Boom section 6 m			1	1	2	3	3	4	4	5	5	6	6	7	7	8	
Boom head 5.5 m	1	1	1	1	1	1	1	1	1	1	1	1	1	1	1	1	
Boom length [m]	11	14	17	20	23	26	29	32	35	38	41	44	47	50	53	56	59
Auxiliary jib	✓	✓	✓	✓	✓	✓	✓	✓	✓	✓	✓	✓	✓	✓	✓	✓	✓

preferred boom combinations











Capacities in [t]

	Boom length [m]														
	11			14			17			20			23		
*	26.3	26.3 	32.3 	26.3	26.3 	32.3 	26.3	26.3 	32.3 	26.3	26.3 	32.3 	26.3	26.3 	32.3 
3	100.0	100.0	100.0												
4	95.0	100.0	100.0	97.2	99.0	99.0	91.5	99.9	99.0	87.1	96.6	100.0			
5	77.2	85.7	88.2	72.9	81.0	87.8	69.0	76.6	87.8	65.5	72.8	81.0	62.2	69.2	77.2
6	57.6	63.9	71.4	57.8	64.1	70.0	55.2	61.4	70.0	52.8	58.7	64.5	50.6	56.3	61.8
7	45.2	50.2	56.2	45.4	50.4	56.3	45.4	50.4	56.3	44.1	49.1	54.2	42.5	47.3	52.4
8	37.1	41.2	46.1	37.2	41.4	46.3	37.3	41.4	46.3	37.3	41.4	46.2	36.5	40.7	44.3
9	31.3	34.8	39.0	31.4	35.0	39.2	31.5	35.0	39.2	31.4	35.0	39.2	31.4	34.9	39.1
10	27.0	30.0	33.7	27.1	30.2	33.8	27.2	30.2	33.8	27.1	30.2	33.9	27.1	30.2	33.8
11	23.6	26.3	29.6	23.7	26.5	29.7	23.8	26.5	29.7	23.8	26.5	29.8	23.7	26.4	29.7
12	20.9	22.6	22.6	21.0	23.5	26.4	21.1	23.6	26.4	21.1	23.5	26.5	21.0	23.5	26.4
13				19.0	21.1	23.7	19.0	21.2	23.7	19.0	21.1	23.8	18.9	21.1	23.7
14				17.1	19.1	21.5	17.2	19.2	21.5	17.2	19.2	21.6	17.1	19.2	21.5
15				15.5	17.4	19.6	15.6	17.5	19.6	15.6	17.5	19.7	15.6	17.4	19.7
16							14.3	16.0	18.1	14.3	16.0	18.1	14.2	16.0	18.1
18							12.1	13.6	15.4	12.1	13.6	15.5	12.1	13.6	15.4
20										10.4	11.8	13.4	10.4	11.8	13.4
22													9.0	10.3	11.7
24													7.9	9.0	10.3

TLT 13649084 0 Preliminary_1. Load charts are calculated according to EN 13000.

- * Rear counterweight in [t]
-  + 15 t carbody counterweight

Capacities in [t]

	Boom length [m]														
	26			29			32			35			38		
*	26.3	26.3 	32.3 	26.3	26.3 	32.3 	26.3	26.3 	32.3 	26.3	26.3 	32.3 	26.3	26.3 	32.3 
5	59.3	65.9	73.6	56.5	62.8	66.4									
6	48.5	54.0	60.3	46.6	51.8	57.6	44.8	49.8	55.1	43.0	47.9	52.5	41.4	46.2	46.6
7	40.9	45.6	50.0	39.4	44.0	48.1	38.0	42.4	46.4	36.7	41.0	44.2	35.4	39.6	42.1
8	35.3	39.3	42.9	34.1	38.0	41.3	33.0	36.8	40.0	31.9	35.6	38.5	30.8	34.5	37.0
9	30.9	34.5	37.4	29.9	33.4	36.3	29.0	32.4	35.0	28.1	31.4	33.5	27.2	30.5	32.0
10	27.0	30.1	33.2	26.6	29.8	31.8	25.8	28.9	30.7	25.0	28.1	29.8	24.3	27.3	28.6
11	23.6	26.4	29.6	23.5	26.3	28.7	23.2	26.0	27.5	22.5	25.3	26.7	21.8	24.6	25.8
12	21.0	23.4	26.3	20.9	23.3	26.2	20.9	23.2	25.2	20.5	22.9	24.2	19.9	22.3	23.3
13	18.9	21.0	23.6	18.8	20.9	23.6	18.7	20.9	23.2	18.6	20.8	22.2	18.1	20.5	21.2
14	17.0	19.1	21.4	16.9	19.0	21.3	16.8	18.9	21.2	16.7	18.8	20.9	16.6	18.7	19.8
15	15.5	17.4	19.6	15.4	17.3	19.5	15.3	17.2	19.4	15.2	17.1	19.3	15.1	17.0	18.4
16	14.2	15.9	18.0	14.1	15.8	17.9	14.0	15.7	17.8	13.8	15.6	17.7	13.7	15.5	17.2
18	12.0	13.5	15.4	11.9	13.4	15.3	11.8	13.3	15.2	11.7	13.2	15.0	11.6	13.1	14.9
20	10.3	11.7	13.3	10.2	11.6	13.2	10.1	11.5	13.1	10.0	11.4	13.0	9.9	11.2	12.9
22	9.0	10.2	11.6	8.9	10.1	11.6	8.8	10.0	11.5	8.7	9.9	11.4	8.6	9.8	11.2
24	7.9	9.0	10.3	7.8	8.9	10.2	7.7	8.8	10.1	7.6	8.7	10.0	7.4	8.6	9.9
25	7.4	8.4	9.7	7.3	8.4	9.6	7.2	8.3	9.5	7.1	8.2	9.4	7.0	8.0	9.3
26	6.9	7.9	9.1	6.9	7.9	9.1	6.8	7.8	9.0	6.7	7.7	8.9	6.5	7.6	8.8
28				6.1	7.0	8.1	6.0	6.9	8.0	5.9	6.8	7.9	5.8	6.7	7.8
30							5.3	6.2	7.2	5.2	6.1	7.1	5.1	6.0	7.0
32							4.7	5.5	6.5	4.6	5.4	6.4	4.5	5.3	6.3
34										4.1	4.9	5.8	4.0	4.8	5.6
35										3.8	4.6	5.5	3.7	4.5	5.4
36													3.5	4.2	5.1
38													3.0	3.8	4.6

TLT 13649084 0 Preliminary_1. Load charts are calculated according to EN 13000.

* Rear counterweight in [t]
 + 15 t carbody counterweight











For boom lengths of 38 m or more a second angle transmitter must be used in the boom head.



www.liebherr.com/CranePlanner

 **Crane Planner 2.0**

Capacities in [t]

* Radius [m]	Boom length [m]																	
	41			44			47			50			53			56		59
	26.3	26.3 	32.3 	26.3	26.3 	32.3 	26.3	26.3 	32.3 	26.3	26.3 	32.3 	26.3	26.3 	32.3 	26.3	32.3 	
7	34.2	38.2	40.3	33.0	37.0	37.0	31.9	31.9	31.9									
8	29.8	33.4	34.9	28.9	32.4	33.1	28.0	30.6	30.6	27.1	27.1	27.1	23.2	23.2	23.2	19.5	19.5	16.5
9	26.4	29.6	30.8	25.6	28.7	29.6	24.8	27.8	27.9	24.0	25.2	25.2	22.1	22.1	22.1	19.0	19.0	16.5
10	23.5	26.5	27.4	22.8	25.7	26.2	22.1	25.0	25.1	21.5	23.6	23.6	20.8	20.8	20.8	17.6	17.6	15.3
11	21.2	23.9	24.9	20.7	23.2	23.7	20.1	22.5	22.6	19.3	21.3	21.3	18.7	19.3	19.3	16.6	16.6	14.3
12	19.3	21.7	22.5	18.8	21.1	21.6	18.2	20.5	20.7	17.5	19.4	19.4	17.0	17.8	17.8	15.3	15.3	13.2
13	17.6	19.9	20.9	17.1	19.4	19.9	16.6	18.7	18.9	16.0	18.0	18.0	15.5	16.7	16.7	14.3	14.3	12.2
14	16.1	18.3	19.0	15.6	17.8	18.1	15.2	17.1	17.3	14.6	16.5	16.5	14.1	15.7	15.7	13.4	13.4	11.4
15	14.8	16.8	17.5	14.4	16.4	16.6	14.0	15.8	15.9	13.5	15.2	15.2	13.0	14.4	14.4	12.6	12.6	10.7
16	13.6	15.4	16.4	13.3	15.1	15.5	12.9	14.6	14.8	12.5	14.0	14.0	11.9	13.3	13.3	11.6	11.6	9.9
18	11.5	13.0	14.5	11.3	12.9	13.7	11.0	12.6	13.0	10.6	12.2	12.2	10.2	11.4	11.4	10.1	10.1	8.5
20	9.8	11.1	12.7	9.6	11.0	12.2	9.5	10.9	11.6	9.2	10.6	10.8	8.8	10.2	10.2	9.0	9.0	7.4
22	8.4	9.6	11.0	8.3	9.5	10.9	8.2	9.4	10.4	8.0	9.2	9.7	7.6	8.9	9.0	8.1	8.1	6.7
24	7.3	8.4	9.7	7.2	8.3	9.6	7.1	8.2	9.4	6.9	8.0	8.8	6.6	7.8	8.2	7.3	7.3	6.1
25	6.8	7.9	9.2	6.7	7.8	9.0	6.6	7.6	8.8	6.4	7.5	8.4	6.2	7.3	7.8	7.0	7.0	5.9
26	6.4	7.4	8.6	6.3	7.3	8.4	6.2	7.2	8.3	6.0	7.0	7.9	5.8	6.9	7.4	6.5	6.7	5.7
28	5.6	6.6	7.7	5.5	6.4	7.5	5.4	6.3	7.4	5.2	6.2	7.0	5.0	6.0	6.6	5.7	6.1	5.3
30	5.0	5.8	6.9	4.8	5.7	6.7	4.7	5.6	6.6	4.5	5.4	6.2	4.4	5.3	5.9	5.0	5.4	4.7
32	4.4	5.2	6.2	4.2	5.1	6.0	4.1	4.9	5.8	3.9	4.8	5.6	3.7	4.6	5.2	4.4	4.7	4.1
34	3.8	4.6	5.5	3.7	4.5	5.4	3.5	4.3	5.2	3.4	4.2	5.0	3.2	4.0	4.6	3.8	4.2	3.5
35	3.6	4.4	5.2	3.4	4.2	5.1	3.3	4.1	4.9	3.1	3.9	4.8	3.0	3.7	4.4	3.6	3.9	3.2
36	3.4	4.1	5.0	3.2	4.0	4.8	3.0	3.8	4.7	2.9	3.6	4.5	2.7	3.5	4.2	3.3	3.7	3.0
38	2.9	3.6	4.5	2.8	3.5	4.3	2.6	3.3	4.1	2.4	3.2	4.0	2.3	3.0	3.7	2.8	3.3	2.5
40	2.5	3.2	4.0	2.4	3.0	3.9	2.2	2.9	3.7	2.1	2.7	3.5		2.6	3.2	2.4	2.8	
42				2.0	2.7	3.4		2.5	3.2		2.4	3.1		2.2	2.8	2.0	2.4	
44					2.3	3.0		2.2	2.9		2.0	2.7			2.5		2.0	
45								2.0	2.7			2.5			2.3			
46									2.5			2.4			2.2			
48												2.0						

TLT 13649084 0 Preliminary_1. Load charts are calculated according to EN 13000.

* Rear counterweight in [t]

 + 15 t carbody counterweight

For boom lengths of 38 m or more a second angle transmitter must be used in the boom head.



www.liebherr.com/CranePlanner

 **Crane Planner 2.0**

Lifting operation with fixed jib

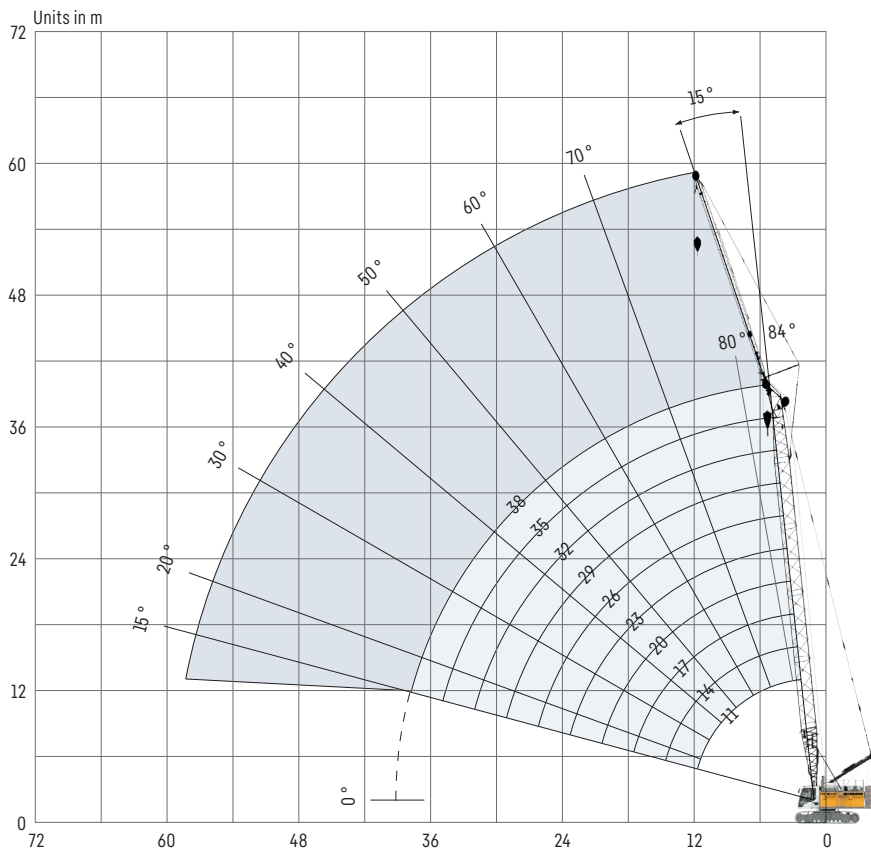

Jib configuration 0806HS

Jib section	Amount of jib sections	
Jib foot 5.5 m	1	1
Jib section 9 m		1
Jib head 5.5 m	1	1
Jib length [m]	11	20

For main boom configuration 20 m - 41 m please refer to the table on page 19.

Load capacities with fixed jib 15° (0806.20)

Jib length 11m with 32.3t rear counterweight and 15t carbody counterweight

Radius [m]	Boom length [m]				
	20	23	32	38	41
9	18.4	18.4			
10	17.8	17.8	17.9		
11	17.1	17.2	17.5	15.7	15.0
12	16.6	16.7	17.1	15.4	14.6
13	16.2	16.3	16.7	15.1	14.3
14	15.7	15.9	16.3	15.0	14.2
16	15.1	15.3	15.6	14.7	14.0
18	14.7	14.9	14.2	13.9	13.8
20	13.7	13.6	13.2	12.3	12.1
22	12.1	12.0	11.6	11.1	10.7
24	10.7	10.6	10.2	9.8	9.7
26	9.5	9.4	9.0	8.7	8.5
28	8.5	8.4	8.0	7.7	7.6
30	7.6	7.5	7.1	6.8	6.7
32		6.7	6.3	6.1	5.9
34			5.7	5.4	5.3
36			5.1	4.8	4.7
38			4.6	4.2	4.1
40			4.0	3.8	3.6
42				3.3	3.1
44				2.9	2.7
46				2.5	2.3

TLT 13649084 0 Preliminary_13. Load charts are calculated according to EN 13000.

Above load charts are for reference only.

For actual lift duty please refer to load chart in operator's cabin or manual.

Jib length 20m with 32.3t rear counterweight and 15t carbody counterweight

Radius [m]	Boom length [m]				
	20	23	32	38	41
12	8.6				
13	8.3	7.9			
14	8.1	7.6	7.9	7.6	7.5
16	7.7	7.4	7.6	7.4	7.3
18	7.3	7.2	7.4	7.2	7.1
20	7.0	7.1	7.2	7.1	7.0
22	6.8	7.0	7.1	7.0	6.9
24	6.5	7.0	7.0	6.9	6.8
26	6.3	6.7	7.0	6.9	6.6
28	6.1	6.4	6.7	6.9	6.5
30	5.9	6.2	6.4	6.6	6.4
32	5.7	6.0	6.2	6.3	6.0
34	5.6	5.4	6.0	5.8	5.6
36	5.5	5.0	5.4	5.2	5.1
38	5.4	4.5	5.0	4.7	4.6
40		4.0	4.5	4.2	4.0
42		3.6	4.0	3.7	3.6
44		3.2	3.6	3.3	3.2
46		2.9	3.2	2.9	2.8
48			2.9	2.6	2.4
50				2.2	2.1

TLT 13649084 0 Preliminary_13. Load charts are calculated according to EN 13000.

Above load charts are for reference only.

For actual lift duty please refer to load chart in operator's cabin or manual.

Transport dimensions and weights

Basic machine and main boom (1311.24)

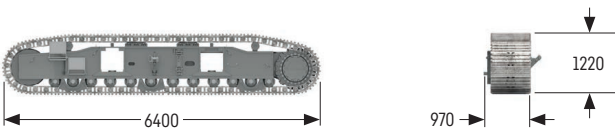
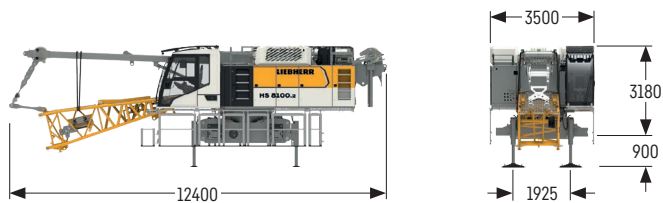
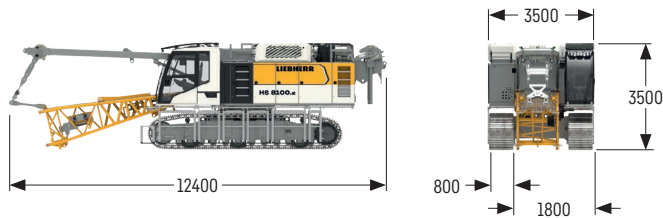

Basic machine

with HD undercarriage, boom foot (1311.24), A-frame, 2x 295 kN winches including wire ropes (90 m), without rear counterweight

Width	mm	3500
Weight with 800 mm 3-web grousers	kg	59300
Weight with 900 mm 3-web grousers	kg	59980
Weight of hoist ropes (2x 90 m)	kg/m	5.68

Basic machine (option)

with boom foot (1311.24), A-frame, 2x 295 kN winches including wire ropes (90 m), without rear counterweight and crawlers

Width	mm	3500
Weight	kg	40230
Weight of hoist ropes (2x 90 m)	kg/m	5.68

Crawler (2x)

3-web grousers	mm	800
Width	mm	915
Weight with 800 mm 3-web grousers	kg	9650
Weight with 900 mm 3-web grousers (option)	kg	9840
Weight with 900 mm flat track pads (option)	kg	10100
Weight with 1000 mm 3-web grousers (option)	kg	10350

Boom section 3 m (1311.24)

Width	mm	1430
Weight incl. pendant ropes	kg	525

Boom section 6 m (1311.24)

Width	mm	1430
Weight incl. pendant ropes	kg	880

Boom head* (No. 1311.24)

Width	mm	1430
Weight incl. pendant ropes	kg	2120

*) Steel sheaves (2+3)

Auxiliary jib

Width	mm	1135
Weight	kg	1085

Weights can vary with the final configuration of the machine. The figures in this brochure may include options which are not within the standard scope of supply of the machine.

Fixed jib

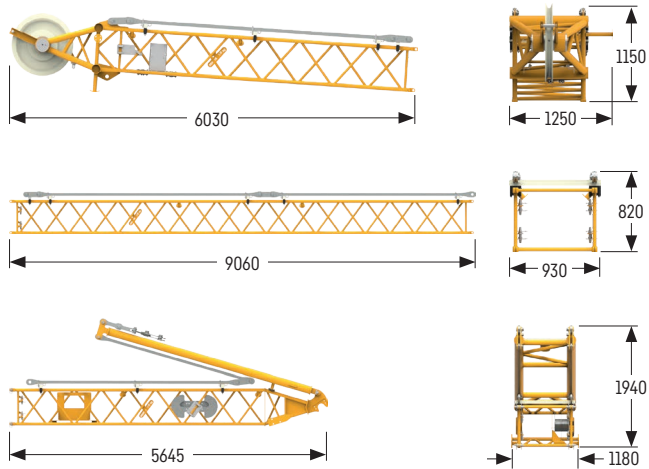

Jib head

Width	mm	1250
Weight	kg	660

Jib section 9 m

Width	mm	930
Weight	kg	577

Jib foot with A-frame

Width	mm	1180
Weight	kg	1067

Counterweight

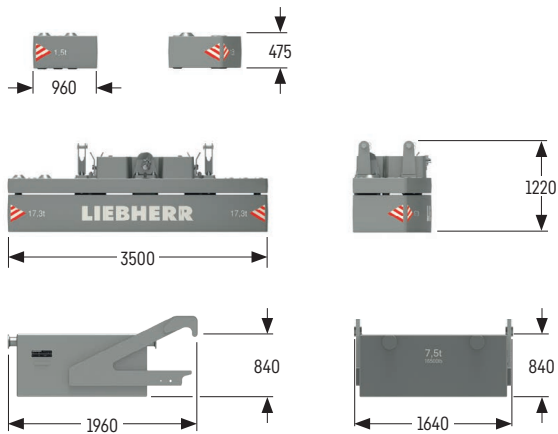

Counterweight slab (standard 6x, option 10x)

Width	mm	850
Weight	kg	1500

Counterweight slab (1x)

Width	mm	1050
Weight	kg	17330

Carbody counterweight (option 2x)

Width	mm	1640
Weight	kg	7500

Hooks

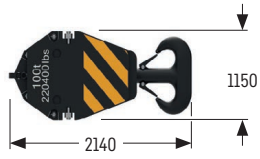

100 t hook block - 2 sheaves

Width	mm	270
Weight	kg	1200

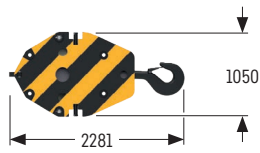

90 t hook block - 1 sheave

Width	mm	348
Weight	kg	1250

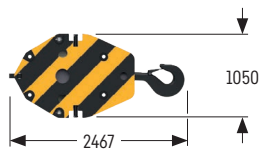

75 t hook block - 1 sheave

Width	mm	192
Weight	kg	1250

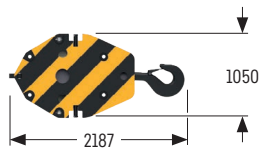

60 t hook block - 1 sheave

Width	mm	162
Weight	kg	970

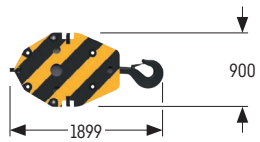

50 t hook block - 1 sheave

Width	mm	230
Weight	kg	750

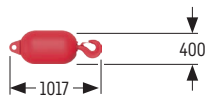

30 t single hook

Width	mm	400
Weight	kg	400

Self-assembly system

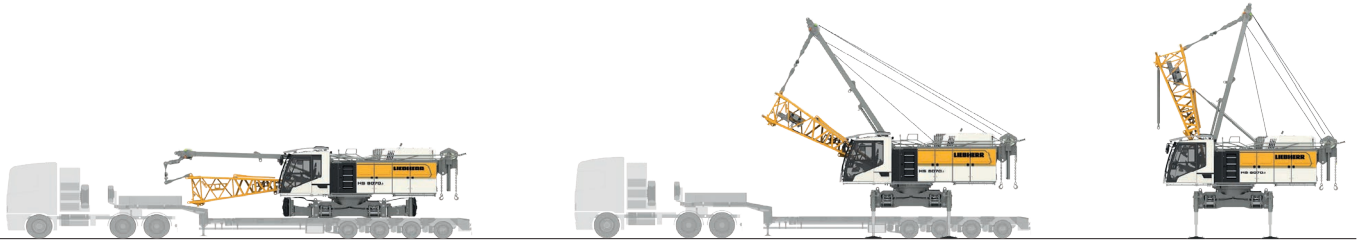

Unloading of basic machine (option)

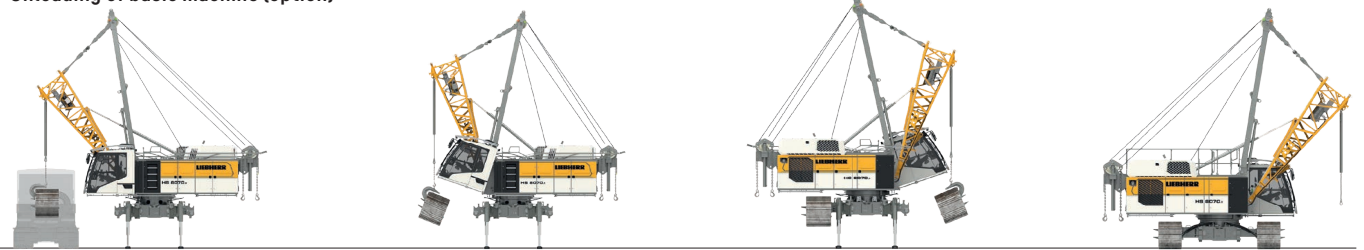

Unloading and assembly of crawlers



Unloading of basic machine (standard)

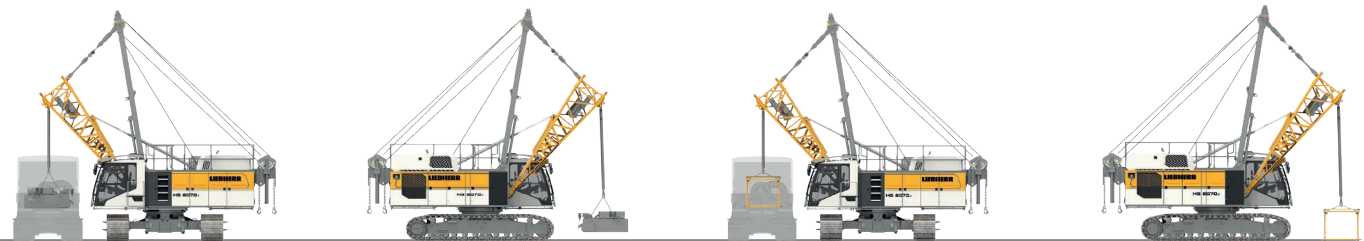

Unloading and assembly of carbody counterweight

Unloading and assembly of boom

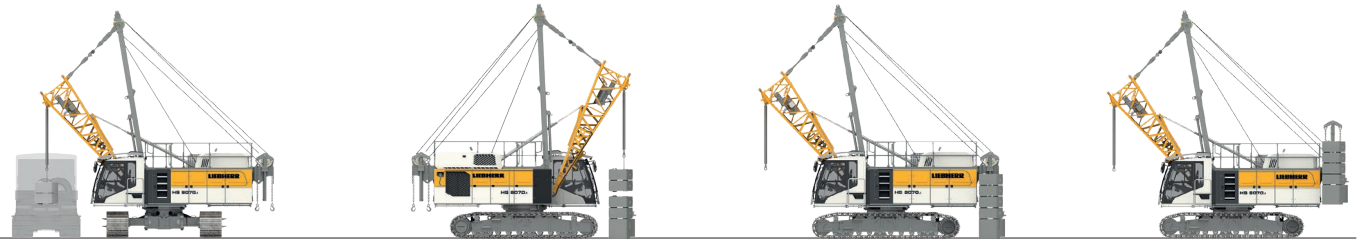

Unloading and assembly of rear counterweight

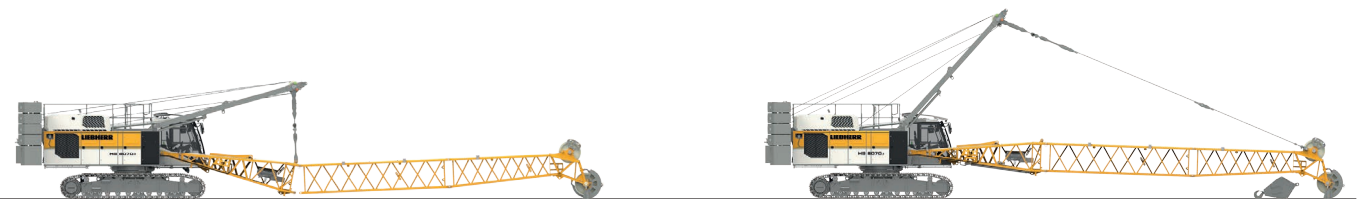

Assembly of boom and reeving of hoist ropes

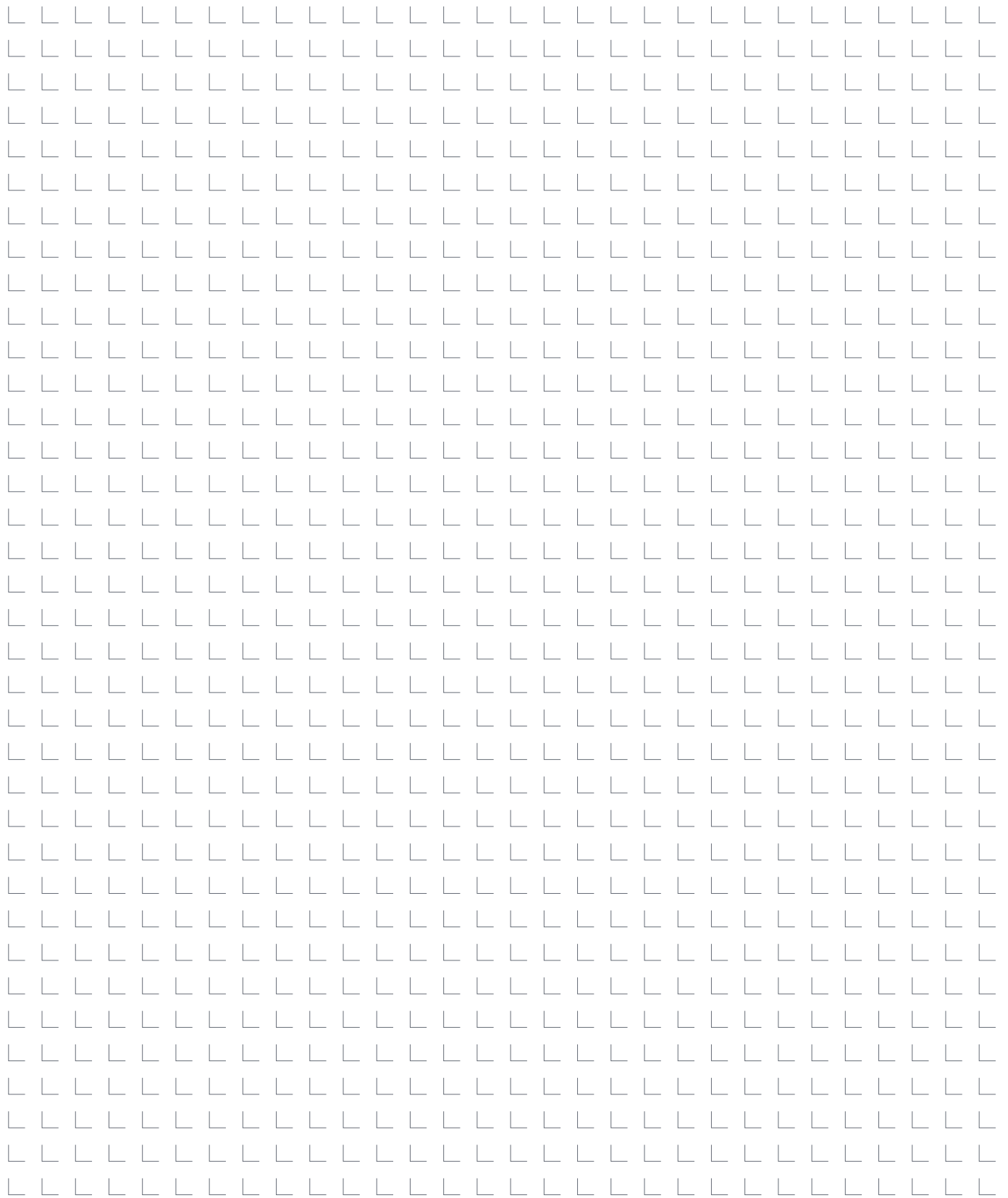

Liebherr-Werk Nenzing GmbH · Dr. Hans Liebherr Str. 1 · 6710 Nenzing, Austria
Phone +43 50809 41-473 · crawler.crane@liebherr.com · www.liebherr.com
facebook.com/LiebherrConstruction